

Adept AnyFeeder

User's Guide



Adept AnyFeeder

User's Guide



P/N: 05284-002, Rev. B
January 2011



5960 Inglewood Drive • Pleasanton, CA 94588 • USA • Phone 925.245.3400 • Fax 925.960.0452

Otto-Hahn-Strasse 23 • 44227 Dortmund • Germany • Phone +49.231.75.89.40 • Fax +49.231.75.89.450

Block 5000 Ang Mo Kio Avenue 5 • #05-12 Techplace II • Singapore 569870 • Phone +65.6755 2258 • Fax +65.6755 0598

The information contained herein is the property of Adept Technology, Inc., and shall not be reproduced in whole or in part without prior written approval of Adept Technology, Inc. The information herein is subject to change without notice and should not be construed as a commitment by Adept Technology, Inc. This manual is periodically reviewed and revised.

Adept Technology, Inc., assumes no responsibility for any errors or omissions in this document. Critical evaluation of this manual by the user is welcomed. Your comments assist us in preparation of future documentation. Please email your comments to: techpubs@adept.com.

Copyright ©2007-2011 by Adept Technology, Inc. All rights reserved.

Adept, the Adept logo, the Adept Technology logo, AdeptVision, AIM, Blox, Bloxview, FireBlox, Fireview, HexSight, Meta Controls, MetaControls, Metawire, Motivity, Motivity by MobileRobots, Soft Machines, and Visual Machines are registered trademarks of Adept Technology, Inc.

Brain on Board is a registered trademark of Adept Technology, Inc. in Germany.

ACE, Adept 1060 / 1060+, Adept 1850 / 1850 XP, Adept 540 Adept 560, Adept AnyFeeder, Adept Award, Adept C40, Adept C60, Adept CC, Adept Cobra 350, Adept Cobra 350 CR/ESD, Adept Cobra 550, Adept 550 CleanRoom, Adept Cobra 600, Adept Cobra 800, Adept Cobra i600, Adept Cobra i800, Adept Cobra PLC server, Adept Cobra PLC800, Adept Cobra s600, Adept Cobra s800, Adept Cobra s800 Inverted, Adept Cobra Smart600, Adept Cobra Smart800, Adept DeskTop, Adept FFE, Adept FlexFeeder 250, Adept IC, Adept iSight, Adept Impulse Feeder, Adept LineVision, Adept MB-10 ServoKit, Adept MC, Adept MotionBlox-10, Adept MotionBlox-40L, Adept MotionBlox-40R, Adept MV, Adept MV-10, Adept MV-19, Adept MV4, Adept MV-5, Adept MV-8, Adept OC, Adept PAC, Adept Python, Adept Quattro s650, Adept Quattro s650H, Adept Quattro s650HS, Adept Quattro s800H, Adept Quattro s800HS, Adept sDIO, Adept SmartAmp, Adept SmartAxis, Adept SmartController CS, Adept SmartController CX, Adept SmartModule, Adept SmartMotion, Adept SmartServo, Adept sMI6, Adept sSight, Adept Viper s650, Adept Viper s850, Adept Viper s1300, Adept Viper s1700, Adept Viper s2000, AdeptCartesian, AdeptCast, AdeptForce, AdeptFTP, AdeptGEM, AdeptModules, AdeptMotion, AdeptMotion Servo, AdeptMotion VME, AdeptNet, AdeptNFS, AdeptOne, AdeptOne-MV, AdeptOne-XL, AdeptRAPID, AdeptSight, AdeptSix, AdeptSix 300, AdeptSix 300 CL, AdeptSix 300 CR, AdeptSix 600, AdeptTCP/IP, AdeptThree, AdeptThree-MV, AdeptThree-XL, AdeptTwo, AdeptVision, AVI AdeptVision, AGS AdeptVision GV, AdeptVision I, AdeptVision II, AdeptVision VME, AdeptVision VXL, AdeptVision XGS, AdeptVision XGS II, AdeptWindows, AdeptWindows Controller, AdeptWindows DDE, AdeptWindows Offline Editor, AdeptWindows PC, AIM Command Server, AIM Dispense, AIM PCB, AIM VisionWare, A-Series, FlexFeedWare, HyperDrive, IO Blox, MicroV+, MotionBlox, MotionWare, ObjectFinder, ObjectFinder 2000, PackOne, PalletWare, sAVI, S-Series, UltraOne, V, V+ and VisionTeach are trademarks of Adept Technology, Inc.

Any trademarks from other companies used in this publication are the property of those respective companies.

Printed in the United States of America

Table of Contents

1	Overview	11
1.1	Introduction	11
1.2	About Your Adept AnyFeeder	11
1.3	Other Items You Need	12
1.4	Warnings, Cautions, and Notes in Manual	12
1.5	Sound Emissions	13
1.6	Workcell	13
1.7	Qualification of Personnel	14
1.8	Safety Equipment for Operators	15
1.9	Protection Against Unauthorized Operation	15
1.10	Safety Aspects While Performing Maintenance	15
1.11	Risks That Cannot Be Avoided	15
1.12	Risks Due to Incorrect Installation or Operation	16
1.13	What to Do in an Emergency	16
1.14	How Can I Get Help?	16
	Related Manuals	16
	Adept Document Library	17
2	Installation	19
2.1	Introduction	19
2.2	Unpacking	20
2.3	Mechanical Installation	22
	Preparing a Mounting Location	22
	Moving the Adept AnyFeeder to the Mounting Location	23
2.4	Installing the Pneumatic Line	24
2.5	Installing Cables and Power	25
	System Cable Diagram	25
	Serial Cable Installation	26
	Serial Cable Wiring Assignments	26
	Digital I/O Cable Installation	27
	Digital I/O Cable Wiring Assignments	27
	Connecting the Power Cable	28
	Setting the Switches	29
2.6	Verifying the Installation	30

3	Using the AnyFeeder with Serial Communications	31
3.1	Introduction	31
3.2	System Requirements	31
3.3	Program Flow	31
3.4	Programming/Using the AnyFeeder with Adept ACE	32
3.5	Serial Communications	32
	Setting the Serial Port Communication Parameters	32
3.6	Serial Command Codes	33
	Sending Commands to the Adept AnyFeeder	33
	Adept AnyFeeder Responses	37
	Responses	37
	Standard Responses	38
	AnyFeeder Command Parameters Default Values	38
	Serial Dialog Examples	39
	Initializing the AnyFeeder	39
	Feeding Parts Forward	39
	Changing the Feed Forward Repetitions and Execute	40
	Set Feed/Flip Forward Turns and Execute	40
	AnyFeeder not Initialized	40
	Flip Drive has a Servo Problem	41
	Unknown Command	41
4	Using the AnyFeeder with Digital I/O	43
4.1	Digital I/O Wiring Assignments	43
4.2	Digital I/O Communications	44
	Signal Handshake	44
4.3	Commands and Parameters	46
5	Maintenance	49
5.1	Introduction	49
5.2	Periodic Maintenance	49
5.3	Removing and Installing the Feed Surface	50
6	Optional Equipment	53
6.1	Introduction	53
6.2	Backlight	53
7	Dimension Drawings	55
7.1	Dimensions	55

A	Controlling the AnyFeeder from V+	57
A.1	Overview	57
A.2	V+ Keywords	57
	VPARAMETER program instruction	58
	VRUN program instruction	60
	VWAITI program instruction	61
	VSTATE real-valued function	62
	Example V+ Code	63
Index	65

List of Figures

- Figure 1-1. Adept AnyFeeder 11
- Figure 2-1. AnyFeeder Parts 20
- Figure 2-2. Shipping Screws on Mounting Rail 21
- Figure 2-3. Preparing the Mounting Location 22
- Figure 2-4. Handles for Lifting/Moving the Adept AnyFeeder 23
- Figure 2-5. Pneumatic Connector Location 24
- Figure 2-6. Air Line Attached to Pneumatic Connector 24
- Figure 2-7. System Cable Diagram 25
- Figure 2-8. Serial Cable 26
- Figure 2-9. DIO Cable 27
- Figure 2-10. DC Power Cable 28
- Figure 2-11. 24 VDC In Connector 28
- Figure 2-12. Com Mode Selection Switches 29
- Figure 2-13. I/O Power and Motor Power LEDs 30
- Figure 2-14. Serial Mode Indicator LED 30
- Figure 4-1. Digital Inputs and Outputs 45
- Figure 5-1. Feed Deck and Drive Block 50
- Figure 6-1. Removing the Feed Platform Front Cover 53
- Figure 6-2. Backlight Power Plug Installed 54
- Figure 6-3. Connection to Backlight 54
- Figure 6-4. Securing Backlight to AnyFeeder 54
- Figure 7-1. Adept AnyFeeder Dimensions 55

1.1 Introduction

This manual describes the key points for getting your Adept AnyFeeder operational. Before getting started, make sure you have all the components necessary to set up your Adept AnyFeeder. In addition to the Adept AnyFeeder (shown in [Figure 1-1](#) below), it is assumed that you have the appropriately configured Adept-controlled robot with vision guidance. (See [Section 1.3](#) and [Section 2.1](#) for details.)



Figure 1-1. Adept AnyFeeder

1.2 About Your Adept AnyFeeder

Your Adept AnyFeeder provides flexible parts feeding without the limitations of a hard-tooled feed system (such as a bowl-feeder or tray-feeding system). The Adept AnyFeeder is designed for feeding a wide variety of parts with rapid change-over times.

Your Adept AnyFeeder package includes:

- Adept AnyFeeder SX240 (P/N 05284-001)
- White Flat Feed Surface (P/N 05284-101)
- 24 VDC Power Cable, 5 m (P/N 05284-301)
- Parallel DIO (Digital I/O) cable, 5 m (P/N 05284-302)
- RS232 Cable, 4.5 m (P/N 05284-303)
- RS232 Loopback Connector (not used for Serial installations) (P/N 05284-304)

To increase the flexibility of your Adept AnyFeeder, you may have ordered one or more of the following options:

- Black Flat Feed Surface (P/N 05284-102)
- Red LED (590 nm wavelength) backlighting package (P/N 05284-201)
- Infrared LED (875 nm wavelength) backlighting package (P/N 05284-202)

1.3 Other Items You Need

- Adept robot (Adept Cobra s600/s800, Adept Cobra i600/i800, Adept Viper s650/s850, etc.)
- Adept SmartController CX with Adept vision option installed
- Adept vision-guidance system
- Sturdy mounting table(s) for the Adept robot and Adept AnyFeeder
- Camera-mounting structure
- High-resolution camera with lens
- Camera interface cables
- Personal computer (for interfacing with and programming the robot and vision system)

1.4 Warnings, Cautions, and Notes in Manual

There are six levels of special alert notation used in this manual. In descending order of importance, they are:



DANGER: This indicates an imminently hazardous electrical situation which, if not avoided, will result in death or serious injury.



DANGER: This indicates an imminently hazardous situation which, if not avoided, will result in death or serious injury.



WARNING: This indicates a potentially hazardous electrical situation which, if not avoided, could result in injury or major damage to the equipment.



WARNING: This indicates a potentially hazardous situation which, if not avoided, could result in injury or major damage to the equipment.



CAUTION: This indicates a situation which, if not avoided, could result in damage to the equipment.

NOTE: Notes provide supplementary information, emphasize a point or procedure, or give a tip for easier operation.

1.5 Sound Emissions

The sound emission level of the Adept AnyFeeder depends on the type of parts being fed, speed, and payload. The maximum value is 85 dB.



WARNING: Acoustic emission from the Adept AnyFeeder may be up to 85 dB (A) under worst-case conditions. Typical values will be lower, depending on the type of parts being fed, speed, and payload. Appropriate safety measures should be taken against excessive acoustic emission, such as using ear protection and displaying a warning sign.

1.6 Workcell

The Adept robot systems used with the Adept AnyFeeder have a Manual and an Automatic (AUTO) operating mode. While in Automatic Mode, personnel are not allowed in the workcell.

In Manual mode, operators with additional safety equipment (see [Section 1.8 on page 15](#)) are allowed to work in the workcell. For safety reasons the operator should, whenever possible, stay outside of the workcell to prevent injury. The maximum speed and power of the robot is reduced, but it could still cause injury to the operator.

Before performing maintenance in the workcell of the robot, High Power must be switched off and the power supply of the robot must be disconnected. After these precautions, a skilled person is allowed to maintain the robot. See [Section 1.7](#) for the specifications.



WARNING:

Electrical Hazard!

Impact Hazard!

Never remove any safeguarding and never make changes in the system that will decommission a safeguard.

1.7 Qualification of Personnel

This manual assumes that all personnel have attended an Adept training course and have a working knowledge of the system. The user must provide the necessary additional training for all personnel who will be working with the system.

As noted in this manual, certain procedures should be performed only by **skilled** or **instructed** persons. For a description of the level of qualification, Adept uses the standard terms:

- **Skilled persons** have technical knowledge or sufficient experience to enable them to avoid the dangers, electrical and/or mechanical.
- **Instructed persons** are adequately advised or supervised by skilled persons to enable them to avoid the dangers, electrical and/or mechanical.

All personnel must observe sound safety practices during the installation, operation, and testing of all electrically powered equipment. To avoid injury or damage to equipment, always remove power by disconnecting the AC power from the source before attempting any repair or upgrade activity. Use appropriate lockout procedures to reduce the risk of power being restored by another person while you are working on the system.



WARNING: The user must get confirmation from every entrusted person, before the person starts working with the robot, that the person:

- Has received the manual
- Has read the manual
- Understands the manual
- Will work in the manner specified by the manual

1.8 Safety Equipment for Operators

Adept advises operators to wear extra safety equipment in the workcell. For safety reasons, operators must wear the following when they are in the robot workcell:

- Safety glasses
- Protective headgear (hard hats)
- Safety shoes

Install warning signs around the workcell to ensure that anyone working around the robot system knows they must wear safety equipment.

1.9 Protection Against Unauthorized Operation

The system must be protected against unauthorized use. Restrict access to the keyboard and the pendant by locking them in a cabinet or use another adequate method to prevent access to them.

1.10 Safety Aspects While Performing Maintenance

Only skilled persons with the necessary knowledge about the safety and operation of the equipment are allowed to maintain the robot and controller.



WARNING: During maintenance and repair, the power to the SmartController and robot must be turned off. Use lockout measures to prevent unauthorized users from turning on power.

1.11 Risks That Cannot Be Avoided

Adept robot control system implementation has devices that disable High Power if a system failure occurs. However, certain residual risks or improper situations could cause hazards. The following situations may result in risks that cannot be avoided:

- Failure of software or electronics that may cause high-speed robot motion in Manual mode
- Failure of hardware associated with enabling a device or an E-Stop system

1.12 Risks Due to Incorrect Installation or Operation

Certain risks will be present if installation or operation is not performed properly:

- Purposely defeating any aspect of the safety E-Stop system
- Improper installation or programming of the robot system
- Unauthorized use of cables other than those supplied or use of modified components in the system
- Defeating an interlock so that an operator can enter a workcell with High Power ON

Take precautions to ensure that these situations do not occur.

1.13 What to Do in an Emergency

Press any E-Stop button (a red push-button on a yellow background/field) and then follow the internal procedures of your company or organization for an emergency. If a fire occurs, use CO₂ to extinguish the fire.

1.14 How Can I Get Help?

For details on getting assistance with your Adept software or hardware, you can access the following information sources on the Adept corporate website:

- For contact information: <http://www.adept.com/contact/americas>
- For product support information:
<http://www.adept.com/support/service-and-support/main>
- For user discussions, support, and programming examples:
<http://www.adept.com/forum/>
- For further information about Adept Technology, Inc.: <http://www.adept.com>

Refer to the *How to Get Help Resource Guide* (Adept P/N 00961-00700) for additional information on getting assistance with your Adept software and hardware.

Related Manuals

This manual covers the installation, operation, and maintenance of the Adept AnyFeeder product. There are additional manuals that cover programming the system, reconfiguring installed components, and adding optional components. See the following table. These manuals are available on the Adept Document Library CD-ROM shipped with each system.

Manual Title	Description
<i>Adept SmartController User's Guide</i>	Contains complete information on the installation and operation of the Adept SmartController and the optional sDIO product.
<i>Adept ACE User's Guide</i>	Describes the installation and use of Adept ACE. This guide also provides information on ACE PackXpert packaging applications.
<i>AdeptSight Reference Guide</i>	Describes V+ and microV+ keywords and properties. Also describes framework and tool properties.

Adept Document Library

The Adept Document Library (ADL) contains documentation for Adept products. You can access the ADL from:

- the Adept Software CD shipped with your system
- the Adept website. Select **Support > Document Library** from the Adept home page. To go directly to the Adept Document Library, type the following URL into your browser:

http://www.adept.com/Main/KE/DATA/adept_search.htm

To locate information on a specific topic, use the Document Library search engine on the ADL main page, or select one of the available menu options.

Installation **2**

2.1 Introduction

This chapter describes the installation procedure for the Adept AnyFeeder.

In addition to installing the Adept AnyFeeder, you will need to install the following items in the workcell:

- Robot: one of the following:
 - Adept robot that interfaces with an Adept SmartController CX, running V+ version 16.x or later
- OR
- Adept i-Series robot (Adept Cobra i600 or Adept Cobra i800 robot)
- Vision: an Adept SmartController CX
- Licenses: V+ Extension, Guided Vision
- An available serial port
- Camera: a user-supplied camera (with lens) and a vision system
- Camera interface cables
- User-supplied personal computer (for interfacing with and programming the robot and vision system)
- All required safety devices (light curtains, guarding, etc.) for the workcell

2.2 Unpacking

This section describes the procedure for unpacking the Adept AnyFeeder.

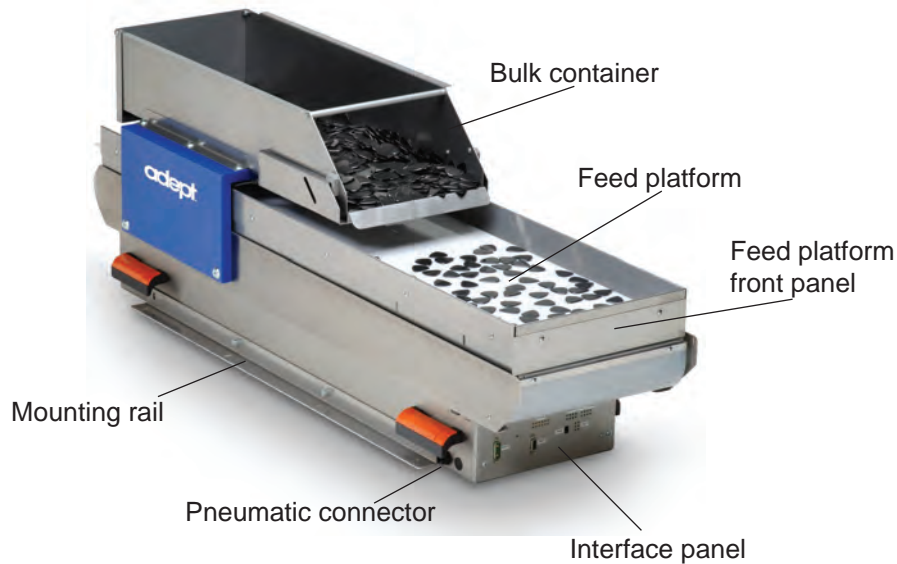

Figure 2-1. AnyFeeder Parts

The Adept AnyFeeder is shipped in a carton that is banded onto a wooden pallet. The shipping carton with pallet is approximately 1219 mm (48 in) x 762 mm (30 in) x 431.8 mm (17 in) (L x W x H). The shipping carton with pallet weighs approximately 80 kg.

To unpack the Adept AnyFeeder:

1. Use a forklift or hand truck to move the shipping carton with pallet to the installation area.
2. Cut the banding with a utility knife or scissors.
3. Raise the shipping carton cover straight up until it clears the contents, and then remove it.
4. Detach the Adept AnyFeeder from the shipping pallet by using a 4 mm Allen wrench and 10 mm wrench or socket to remove the four (4) screws from the mounting rails of the Adept AnyFeeder, as shown in [Figure 2-2](#).



Figure 2-2. Shipping Screws on Mounting Rail

2.3 Mechanical Installation

This section describes the mechanical installation procedure for the Adept AnyFeeder.

Preparing a Mounting Location



WARNING: The Adept AnyFeeder must be bolted or clamped down to the base plate at any time it is in operation. Due to its working principle the Adept AnyFeeder may “walk off” the base plate during operation if it is not properly secured to the base plate.

WARNING: Do not connect the Adept AnyFeeder to electrical power or compressed air before it is securely bolted or clamped down to the base plate.

Before the Adept AnyFeeder can be used, it must be securely mounted in a prepared location within the robot’s workcell.

Prepare the mounting hole pattern as shown in [Figure 2-3](#). Locate the mounting hole pattern on the base plate so that at least 650 mm of the AnyFeeder’s base housing rests on the base plate, as shown in [Figure 2-3](#).

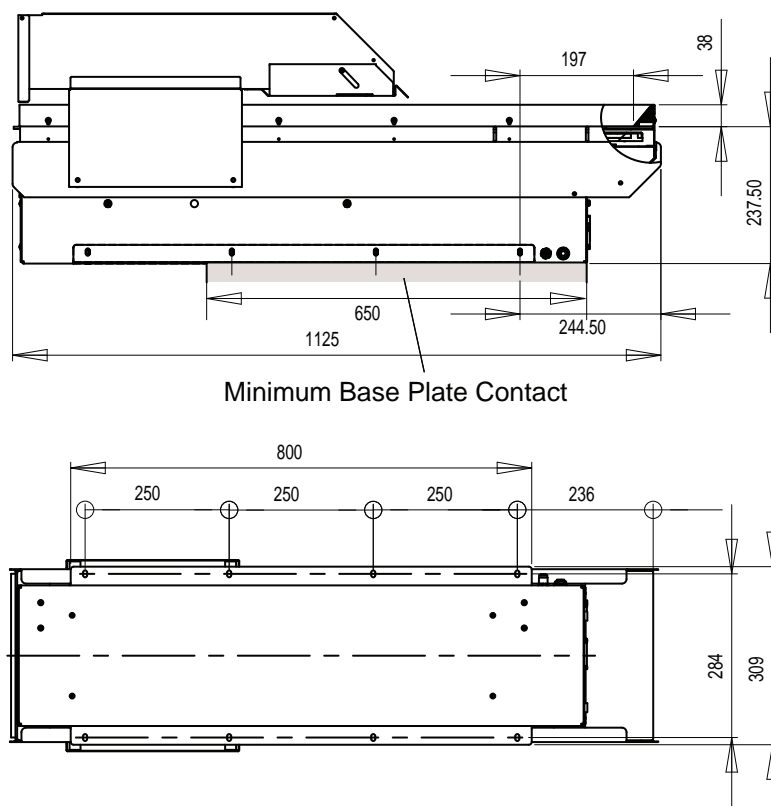

Figure 2-3. Preparing the Mounting Location

Moving the Adept AnyFeeder to the Mounting Location



WARNING: Two people must lift and move the Adept AnyFeeder to the prepared location. Lift the Adept AnyFeeder only by holding it at the base housing at the handles indicated below.

1. Find a co-worker to help you move the Adept AnyFeeder.
2. Lift the Adept AnyFeeder by the handles shown in [Figure 2-4](#).

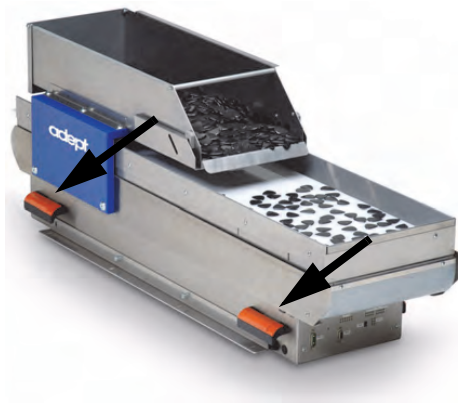

Figure 2-4. Handles for Lifting/Moving the Adept AnyFeeder

3. Move the Adept AnyFeeder to the prepared mounting location.
4. Bolt the Adept AnyFeeder to the mounting location by inserting at least four (4) M6 x 16 mm Allen screws with washers and lock washers through the holes in the feeder's mounting rails (use at least two screws in each mounting rail).

2.4 Installing the Pneumatic Line

This section describes the pneumatic installation procedure for the Adept AnyFeeder.

1. Locate the pneumatic connector below the side handle on the Adept AnyFeeder (see [Figure 2-5](#)).



Figure 2-5. Pneumatic Connector Location

2. Prepare an 8 mm OD air line.
3. Attach the air line to the pneumatic connector (see [Figure 2-6](#)). Do not overtighten the connection.



Figure 2-6. Air Line Attached to Pneumatic Connector

2.5 Installing Cables and Power

This section describes the electrical installation procedure for the Adept AnyFeeder. The Adept AnyFeeder requires the following cable connections:

- the 24 VDC power cable (supplied)
- the RS232 serial communications cable (supplied)
- the DIO (Digital I/O) cable (supplied)

System Cable Diagram

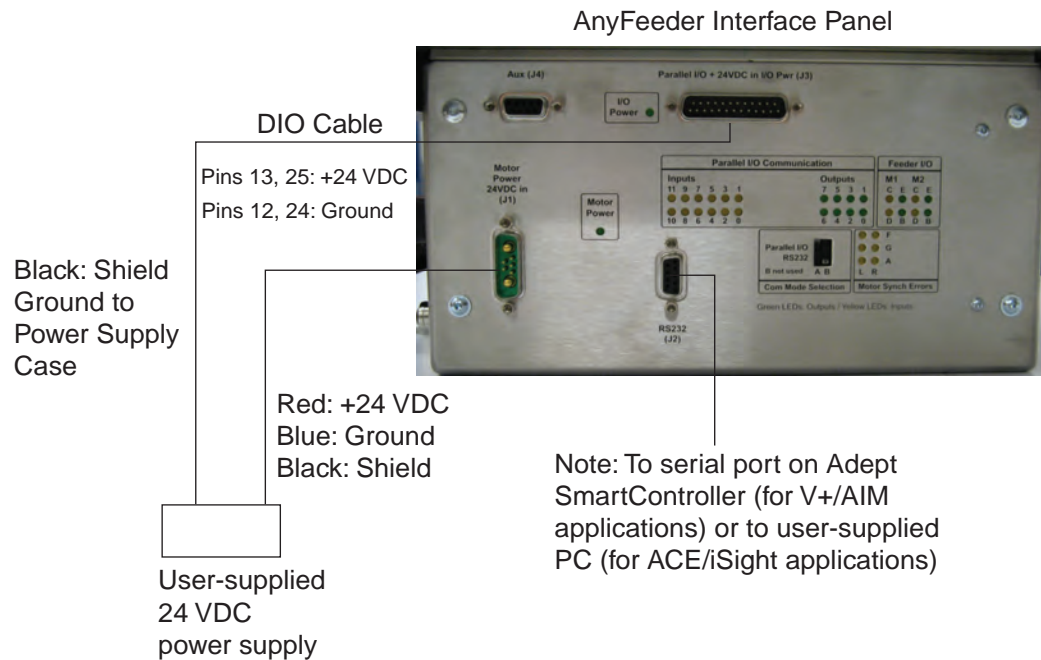

NOTE: Refer to your robot user's guide for additional system cable information.

NOTE: The Adept AnyFeeder is equipped with fuses to protect the internal components. The motor power 24 VDC input is protected with a 10 Amp fuse, and the parallel I/O 24 VDC lines are protected with a 3 Amp fuse. These fuses can be replaced in the field. If you suspect a problem with one or both of these fuses, contact Adept Customer Service (see [Section 1.14 on page 16](#)) for part information and instructions.

Serial Cable Installation

A serial communications cable is supplied with the Adept AnyFeeder (see [Figure 2-8](#)). Connect the male end of the cable to the RS232 (J2) port on the Adept AnyFeeder. Connect the female end of the cable to the serial port on the robot controller or PC.

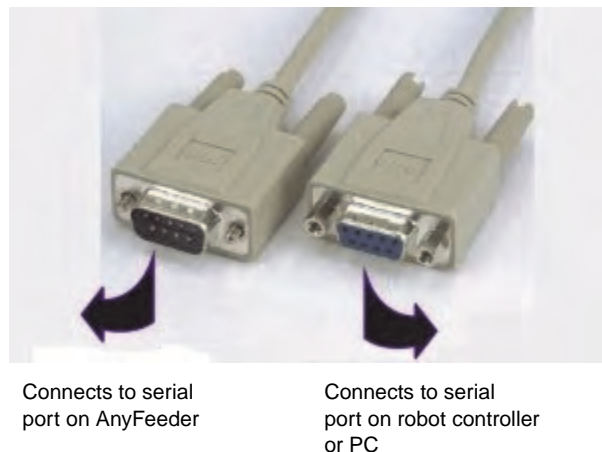

Figure 2-8. Serial Cable

Serial Cable Wiring Assignments

[Table 2-1](#) shows the wiring assignments for the supplied cable.

Table 2-1: Serial Cable Wiring Assignments

Pin # DSUB 9 male (to AnyFeeder)	Function	Pin # DSUB 9 female (to controller)
2	RX	2
3	TX	3
5	GROUND	5

Digital I/O Cable Installation

A digital I/O cable is supplied with the Adept AnyFeeder (see [Figure 2-9](#)). Connect the female end of the cable to the parallel I/O +24 VDC in I/O Pwr (J3) port on the Adept AnyFeeder.



Figure 2-9. DIO Cable

Digital I/O Cable Wiring Assignments

The supplied digital I/O cable must be wired as shown in [Table 2-2](#).

NOTE: If you want to communicate with your Adept AnyFeeder using digital I/O rather than serial communications, refer to [Chapter 4](#) for the cable pin/wire assignments.

NOTE: Regardless of your method of communicating with the Adept AnyFeeder (DIO or RS232 Serial), you must supply power to the logic board through this cable on the pins specified in [Table 2-2](#).

Table 2-2: Digital I/O Wiring Assignments

Function	Pin # DSUB 25	Wire Color	Power Supply Robot Controller
+24 VDV	25	WH / BK	+24 VDC
+24 VDC	13	WH / GN	+24 VDC
0 VDC	24	BN / RD	0 VDC
0 VDC	12	RD / BU	0 VDC
Shield	N/A	BK	Ground to Case

Connecting the Power Cable

1. Locate the DC power cable with connector that was supplied with the Adept AnyFeeder (see [Figure 2-10](#)).



Figure 2-10. DC Power Cable

2. Connect the wire end of the cable to the user-supplied 24 VDC / 10 A regulated power supply.
3. Attach the connector end of the cable to the Motor Power 24 VDC In (J1) connector on the front of the Adept AnyFeeder (see [Figure 2-11](#)).

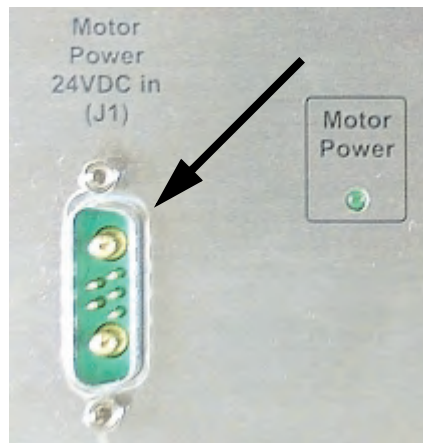

Figure 2-11. 24 VDC In Connector

Setting the Switches

The Adept AnyFeeder will be set for serial communications. The Com Mode Selection switches (see [Figure 2-12](#)) must be set as follows:

1. Move the A switch (selects Parallel I/O or RS232) to the down position, to select Serial.

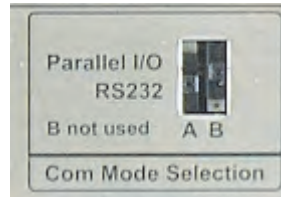

Figure 2-12. Com Mode Selection Switches

After changing the switch settings, you must cycle power to the Adept AnyFeeder.

- If the Adept AnyFeeder and connected equipment are powered from a common source, you can turn that source off and then back on.
- If the Adept AnyFeeder and connected equipment are powered from different sources, then you must disconnect and then reconnect the following cables:
 - 24 VDC power cable. See [“Connecting the Power Cable” on page 28](#) for details
 - Digital I/O interface cable. See [“Digital I/O Cable Installation” on page 27](#) for details

2.6 Verifying the Installation

This section describes the procedure for verifying the Adept AnyFeeder after installation.

After wiring the system, turn on the 24 VDC power supply and verify that the two (2) Status LEDs are on (see [Figure 2-13](#)).

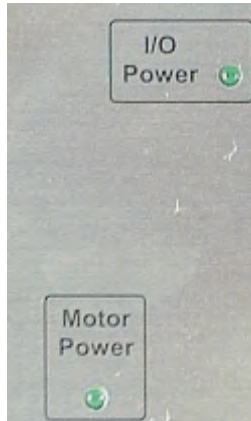

Figure 2-13. I/O Power and Motor Power LEDs

Additionally, the LED shown in [Figure 2-14](#) will blink to indicate Serial mode.

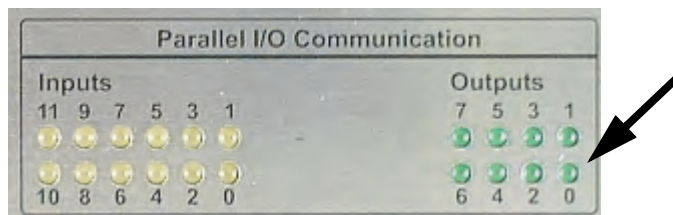

Figure 2-14. Serial Mode Indicator LED

Using the AnyFeeder with Serial Communications

3

3.1 Introduction

This chapter describes the requirements for using the Adept AnyFeeder with a robot/vision system and serial communications.

3.2 System Requirements

To use the Adept AnyFeeder with a robot/vision system, your workcell must contain the equipment described in [Section 2.1 on page 19](#).

3.3 Program Flow

The steps below briefly describe a simple program flow for using the Adept AnyFeeder in the workcell:

1. Initialize the Adept AnyFeeder.
2. Send “dispense” command to Adept AnyFeeder to feed parts.
3. Acquire vision image and locate “usable” parts; store part count.
4. Command robot to pick-place the usable parts; decrement part count for each pick.
5. When part count reaches 0, send combinations of “feed forward,” “feed backward,” “flip,” “feed/flip forward,” and “feed/flip backward” commands, along with acquiring vision images, to locate more usable parts.
 - a. If usable parts are found, store part count and loop back to [step 4](#).
 - b. If no usable parts are found, and feed area is not empty, repeat [step 5](#).
 - c. If no usable parts are found, and feed area is empty, go to [step 2](#).

3.4 Programming/Using the AnyFeeder with Adept ACE

You can use an AnyFeeder object (control panel) in Adept ACE to configure the AnyFeeder for your application (in this case, you would likely use the Process Manager in Adept ACE to create the application; the Process Manager allows you to include the AnyFeeder object in your process). See the *Adept ACE User's Guide* for information. See [Appendix A on page 57](#) for information on V+ programming.

3.5 Serial Communications

This section describes how to set up serial communications with the Adept AnyFeeder.

NOTE: If you want to communicate with your Adept AnyFeeder using digital I/O rather than serial communications, refer to [Chapter 4](#) for the cable pin/wire assignments.

Setting the Serial Port Communication Parameters

In order for the SmartController CX to communicate properly with the Adept AnyFeeder, you must configure the serial port as follows:

Table 3-1: Serial Port Settings

Item	Setting
Baud rate	9600
Data bits	8
Stop bit	1
Parity	none
Flow control	none
In addition to the above:	
- Disable local echo	
- Append "line feed" to each line sent	
- Append "line feed" to each line received	

NOTE: The Adept AnyFeeder will not receive or send any serial data if the baud rate is not set correctly.

3.6 Serial Command Codes

The following sections describe:

- The serial commands that can be sent to the Adept AnyFeeder
- The default values for the Adept AnyFeeder command parameters
- How the Adept AnyFeeder responds to received commands
- Sample serial communications dialogs

Sending Commands to the Adept AnyFeeder

Table 3-3 provides a list of all available Adept AnyFeeder serial commands. With each command there is a maximum of two associated parameters which influence that command. Note that some commands do not need any parameters.

During startup, the Adept AnyFeeder firmware assigns default values to all parameters. For example, if you send the Adept AnyFeeder a “feed forward” command without first changing any of its parameters, the Adept AnyFeeder control system will apply the default parameters (see **Table 3-7** for details).

Table 3-2: Description of Symbols used in Tables

Symbol	Description
>	Represents the prompt of a text terminal window
<cr>	Carriage return, ASCII code 13 (decimal)
[speed]	Integer in the range 1...10
[turns]	Integer in the range 1...10, except for purge (range is 1...127)
_	Explicit space (not an underscore)
Note that all text in the Syntax column is case sensitive	

See **Table 3-6, “Standard Responses,”** on page 38 for a list of standard responses.

Table 3-3: AnyFeeder Serial Commands

Command	Description	Syntax	Explanation	Response
Feed Forward [ffwd]	Feed parts forward	> x=1<cr>	Executes a feed forward	Standard response
Feed Backward [fbwd]	Feed parts backward	> x=2<cr>	Executes a feed backward	Standard response
Feed + Flip Forward [flipfwd]	Flip parts forward	> x=3<cr>	Executes a flip forward	Standard response
Feed + Flip Backward [flipbwd]	Flip parts backward	> x=4<cr>	Executes a flip backward	Standard response

Table 3-3: AnyFeeder Serial Commands

Command	Description	Syntax	Explanation	Response
Flip [flip]	Flip parts without moving forward or backward	> x=5<cr>	Executes a flip	Standard response
Dispense [dispense]	Move parts from the bulk container onto the feed surface	> x=6<cr>	Executes a dispense	Standard response
Purge [purge]	Feed parts out backwards, purge gate must be opened manually	> x=7<cr>	Executes a purge	Standard response
Heavy Dispense [hdisp]	Aggressively move parts from bulk container onto feed surface	> x=8<cr>	Executes a heavy dispense	Standard response
Initialize [init]	Move the AnyFeeder into its home position; required before any other action can take place	> x=16<cr>	Initializes the AnyFeeder	Standard response
Stop [stop]	Stop current action and move AnyFeeder to home position	> x=15<cr>	Executes a stop	Standard response
Startup AnyFeeder firmware	Start AnyFeeder firmware (also stops active motions)	> S_RUN<cr>	Restarts AnyFeeder firmware	AnyFeeder will respond: m10<cr> m20<cr> to indicate AnyFeeder is online
Reset Error	Reset error status and moves AnyFeeder to home position	> x=30<cr>	Resets error status	Standard response
Restart Firmware	Restart AnyFeeder firmware; resets all parameters to default values	> x=31<cr>	Restarts AnyFeeder firmware and resets defaults	Standard response

Table 3-4: Setting Parameters

Command	Description	Syntax	Explanation	Response
Setting the Number of Repetitions				
Set Feed Forward repetitions	Set number of repetitions for feed forward	> ab[1]=[turns]<cr>	Sets repetitions	No response
Set Feed Forward repetitions and execute feed forward	Set number of repetitions for feed forward and execute motion	> ab[1]=[turns]_x=1<cr>	Sets repetitions and executes motion	Standard response

Table 3-4: Setting Parameters

Command	Description	Syntax	Explanation	Response
Set Feed Backward repetitions	Set number of repetitions for feed backward	> ab[2]=[turns]<cr>	Sets repetitions	No response
Set Feed Backward repetitions and execute feed backward	Set number of repetitions for feed backward and execute motion	> ab[2]=[turns]_x=2<cr>	Sets repetitions and executes motion	Standard response
Set Feed + Flip Forward repetitions	Set number of repetitions for feed flip forward	> ab[3]=[turns]<cr>	Sets repetitions	No response
Set Feed + Flip Forward repetitions and execute flip forward	Set number of repetitions for feed flip forward and execute motion	> ab[3]=[turns]_x=3<cr>	Sets repetitions and executes motion	Standard response
Set Feed + Flip Backward repetitions	Set number of repetitions for feed flip backward	> ab[4]=[turns]<cr>	Sets repetitions	No response
Set Feed + Flip Backward repetitions and execute flip backward	Set number of repetitions for feed flip backward and execute motion	> ab[4]=[turns]_x=4<cr>	Sets repetitions and executes motion	Standard response
Set Flip Repetitions	Set number of repetitions for flip	> ab[5]=[turns]<cr>	Sets repetitions	No response
Set Flip Repetitions and execute flip	Set number of repetitions for flip and execute motion	> ab[5]=[turns]_x=5<cr>	Sets repetitions and executes motion	Standard response
Set Dispense Repetitions	Set number of repetitions for dispense	> ab[6]=[turns]<cr>	Sets repetitions	No response
Set Dispense Repetitions and execute disp	Set number of repetitions for dispense and execute motion	> ab[6]=[turns]_x=6<cr>	Sets repetitions and executes motion	Standard response
Set Purge Repetitions	Set number of repetitions for purge	> ab[7]=[turns]<cr>	Sets repetitions	No response
Set Purge Repetitions and execute purge	Set number of repetitions for purge and execute motion	> ab[7]=[turns]_x=7<cr>	Sets repetitions and executes motion	Standard response
Set Heavy Dispense Repetitions	Set number of repetitions for heavy dispense	> ab[8]=[turns]<cr>	Sets repetitions	No response

Table 3-4: Setting Parameters

Command	Description	Syntax	Explanation	Response
Set Heavy Dispense Repetitions and execute heavy dispense	Set number of repetitions for heavy dispense and execute motion	> ab[8]=[turns]_x=8<cr>	Sets repetitions and executes motion	Standard response
Setting the Speed of Operation				
Set Feed Forward speed	Set speed of feed forward operation	> ab[17]=[speed]_x=17<cr>	Sets speed	Standard response
Set Feed Backward speed	Set speed of feed backward operation	> ab[18]=[speed]_x=18<cr>	Sets speed	Standard response
Set Feed + Flip Forward speed	Set speed of feed flip forward operation	> ab[19]=[speed]_x=19<cr>	Sets speed	Standard response
Set Feed + Flip Backward speed	Set speed of feed flip backward operation	> ab[20]=[speed]_x=20<cr>	Sets speed	Standard response
Set Flip speed	Set speed of flip operation	> ab[21]=[speed]_x=21<cr>	Sets speed	Standard response
Set Dispense speed	Set speed of dispense operation	> ab[22]=[speed]_x=22<cr>	Sets speed	Standard response
Set Purge speed	Set speed of purge operation	> ab[23]=[speed]_x=23<cr>	Sets speed	Standard response
Set Heavy Dispense speed	Set speed of heavy dispense operation	> ab[24]=[speed]_x=24<cr>	Sets speed	Standard response
Other Settings				
Backlight/Strobe mode	Set the state of the optional Backlight (if installed)	> ab[12]=[mode]	Mode: 0: Backlight is OFF 1: Backlight is ON (default) 2: Backlight is strobed (controlled by settings "trigger interval" and "trigger delay")	No response
Vision trigger interval	Sets the vision trigger interval in multiples of 20 ms	> ab[25]=[value]_x=25<cr>	Range for value is 1..63 Default is 240 ms (value=12)	No response
Vision trigger delay	Sets the vision trigger delay in multiples of 20 ms. The trigger delay starts after a AnyFeeder action has completed.	> ab[26]=[value]_x=26<cr>	Range for value is 1..63 Default is 500 ms (value=25)	No response

Table 3-4: Setting Parameters

Command	Description	Syntax	Explanation	Response
Set digital output	Set the state of the AnyFeeder's internal digital outputs. It is not recommended to set these during normal operation, only for debugging purposes.	> ab[27]=[mode]_x=27<cr>	Mode: 0: Engage the dispense clutch 1: Engage the flip clutch 2: Turn backlight OFF 3: Turn backlight ON 4: Move retainer gate UP 5: Move retainer gate DOWN	Standard response

Adept AnyFeeder Responses

After receiving a command, the Adept AnyFeeder will respond with specific characters to indicate the status of each motor in the mechanism.

Motor 1: The “flip” drive, located to the front of the AnyFeeder, under the feed surface

Motor 2: The “dispense” drive, located to the rear of the AnyFeeder, under the bulk container

Responses

mix

Where:

i = the drive number (1 or 2) that is reporting

x = the status of the drive

Table 3-5: AnyFeeder Responses

Response	Meaning	Details
m10	Motor 1 completed action successfully	
m11	Motor 1 received command and is busy	
m12	Invalid command	Command or command syntax incorrect
m13	Motor 1 servo error	Possibly overloaded. Check for obstructions or hardware problems. Error must be reset before operation can continue.
m16	Motor 1 not initialized	AnyFeeder must be initialized before commands can be sent
m17	Motor 1 error state	Motor 1 reporting an error. Error must be reset before operation can continue.
m20	Motor 2 completed action successfully	

Table 3-5: AnyFeeder Responses

Response	Meaning	Details
m21	Motor 2 received command and is busy	
m22	Invalid command	Command or command syntax incorrect
m23	Motor 2 servo error	Possibly overloaded. Check for obstructions or hardware problems. Error must be reset before operation can continue.
m26	Motor 2 not initialized	AnyFeeder must be initialized before commands can be sent.
m27	Motor 2 error state	Motor 2 reporting an error. Error must be reset before operation can continue.
m28	Timeout- no sync-signal received	The sync-signal was not received from Motor 1. Therefore, Motor 2 cannot start its action.

Standard Responses

During normal operation, the responses you should expect to see from the AnyFeeder are as follows.

Table 3-6: Standard Responses^a

Response	Meaning
m21<cr>	Motor 2 understood command and is busy
m11<cr>	Motor 1 understood command and is busy
m20<cr>	Motor 2 completed action successfully and is OK
m10<cr>	Motor 1 completed action successfully and is OK

^a Motors 1 and 2 may report back in different orders, meaning sometimes motor 1 will report back first and sometimes motor 2 will report back first.

Because the two motors perform different motions during the same operation, there will be some time between the responses.

AnyFeeder Command Parameters Default Values

Table 3-7 shows the default values for the AnyFeeder command parameters. Note that whenever the AnyFeeder's firmware is reset, the parameters return to these default values.

Table 3-7: Parameter Default Values

Parameter	Default Value
ab[1]=3	default feed forward repetitions
ab[2]=3	default feed backward repetitions

Table 3-7: Parameter Default Values

Parameter	Default Value
ab[3]=3	default feed and flip forward repetitions
ab[4]=3	default feed and flip backward repetitions
ab[5]=3	default flip repetitions
ab[6]=3	default dispense repetitions
ab[7]=64	default purge repetitions
ab[8]=3	default heavy dispense repetitions
ab[17]=1	feed forward speed
ab[18]=1	feed backward speed
ab[19]=1	feed/flip forward speed
ab[20]=1	feed/flip backward speed
ab[21]=1	flip speed
ab[22]=1	dispense speed
ab[23]=1	purge speed

Serial Dialog Examples

This section provides some examples of serial communication streams for basic Adept AnyFeeder operations.

Initializing the AnyFeeder

Table 3-8 shows responses to the Init command (`x=16<cr>`).

Table 3-8: Initializing the AnyFeeder

Terminal Window	Explanation
m21<cr>	Motor/Drive 2 understood command and is now busy, indicated by the '1'
m11<cr>	Motor/Drive 1 understood command and is now busy, indicated by the second '1'
m10<cr>	Motor/Drive 1 completed action successfully, indicated by '0'
m20<cr>	Motor/Drive 2 completed action successfully

Feeding Parts Forward

Table 3-9 shows responses to the Feed Forward command (`x=1<cr>`).

Table 3-9: Feeding Parts Forward

Terminal Window	Explanation
m21<cr>	Motor/Drive 2 understood command and is now busy, indicated by the '1'

Table 3-9: Feeding Parts Forward

Terminal Window	Explanation
m11<cr>	Motor/Drive 1 understood command and is now busy, indicated by the second '1'
m20<cr>	Motor/Drive 2 completed action successfully, indicated by '0'; in feed commands the 'dispense drive' does not execute a motion, but still confirms that it accepted the command and is 'alive'. A consistent drive reporting scheme is easier to handle by the receiving host computer and the additional communication overhead is minimal.
m10<cr>	Motor/Drive 1 completed action successfully

Changing the Feed Forward Repetitions and Execute

Table 3-10 shows responses to the Feed Forward Repetitions and Execute command (`ab[1]=10 x=1<cr>`).

Table 3-10: Changing the Flip Speed/Intensity

Terminal Window	Explanation
m21<cr>	Drive 2 command understood
m11<cr>	Drive 1 command understood
m10<cr>	Drive 1 finished
m20<cr>	Drive 2 finished

Set Feed/Flip Forward Turns and Execute

Table 3-11 shows responses to the Feed/Flip Forward Turns and Execute command (`ab[3]=6 x=3<cr>`).

Table 3-11: Set Feed/Flip Forward Turns and Execute

Terminal Window	Explanation
m21<cr>	Drive 2 command understood
m11<cr>	Drive 1 command understood
m10<cr>	Drive 1 finished
m20<cr>	Drive 2 finished

AnyFeeder not Initialized

Table 3-12 shows responses to the Feed Forward command before the AnyFeeder has been initialized (`x=1<cr>`).

Table 3-12: AnyFeeder not Initialized

Terminal Window	Explanation
m26<cr>	Drive 2 reports that it is not initialized

Table 3-12: AnyFeeder not Initialized

Terminal Window	Explanation
m16<cr>	Drive 1 reports that it is not initialized

Flip Drive has a Servo Problem

Table 3-13 shows responses to the Flip command when the flip drive has a servo problem (x=5<cr>).

Table 3-13: Flip Drive has a Servo Problem

Terminal Window	Explanation
m21<cr>	Drive 2 reports that it is not initialized
m11<cr>	Drive 1 reports that it is not initialized
m20<cr>	Drive 2 reports end of motion
m13<cr>	Drive 1 reports a servo error

Unknown Command

Table 3-14 shows responses to an unknown command (x=9<cr>).

Table 3-14: Unknown Command

Terminal Window	Explanation
m22<cr>	Drive 2 reports that this is an unknown command
m12<cr>	Drive 1 reports that this is an unknown command

Using the AnyFeeder with Digital I/O

4

4.1 Digital I/O Wiring Assignments

To use the Adept AnyFeeder system with digital I/O communications, refer to [Table 4-1](#) for the cable pin/wire assignments.

Table 4-1. Digital I/O Wiring Assignments

AnyFeeder Function	AnyFeeder Pin # DSUB 25	Wire Color	Power Supply/ SmartController Function
+24 VDV	25	WH / BK	+24 VDC
+24 VDC	13	WH / GN	+24 VDC
0 VDC	24	BN / RD	0 VDC
0 VDC	12	RD / BU	0 VDC
OUT 1	14	BN / GN	IN 1
OUT 2	1	WH	IN 2
OUT 3	15	WH / YE	IN 3
OUT 4	2	BN	IN 4
OUT 5	16	YE / BN	IN 5
OUT 6	3	GN	IN 6
OUT 7	17	WH / GY	IN 7
OUT 8	4	YE	IN 8
IN 1	18	GY / BN	OUT 1
IN 2	5	GY	OUT 2
IN 3	19	WH / PK	OUT 3
IN 4	6	PK	OUT 4
IN 5	20	PK / BN	OUT 5
IN 6	7	BU	OUT 6
IN 7	21	WH / BU	OUT 7

Table 4-1. Digital I/O Wiring Assignments

AnyFeeder Function	AnyFeeder Pin # DSUB 25	Wire Color	Power Supply/ SmartController Function
IN 8	8	RD	OUT 8
IN 9	22	BN / BU	OUT 9
IN 10	9	BK	OUT 10
IN 11	23	WH / RD	OUT 11
IN 12	10	VT	OUT 12
not used	11	GY / PK	not used
Shield, ground to case	N/A	BK	

4.2 Digital I/O Communications

This section describes the Adept AnyFeeder system digital I/O communications.

Signal Handshake

Communication works on the basis of a master/slave relationship. For a given situation, the master sends the Adept AnyFeeder a command, the Adept AnyFeeder confirms reception of the command, executes it, and reports the status back to the master (whether the command completed successfully or not).

As viewed from the robot/controller (master) side, the digital I/O interface consists of 12 digital outputs and 8 digital inputs (see [Figure 4-1](#)).

- The 12 outputs are used by the master controller to send the Adept AnyFeeder an action command or set a parameter.
- The 8 inputs return information about the Adept AnyFeeder status and report if an action has been completed.

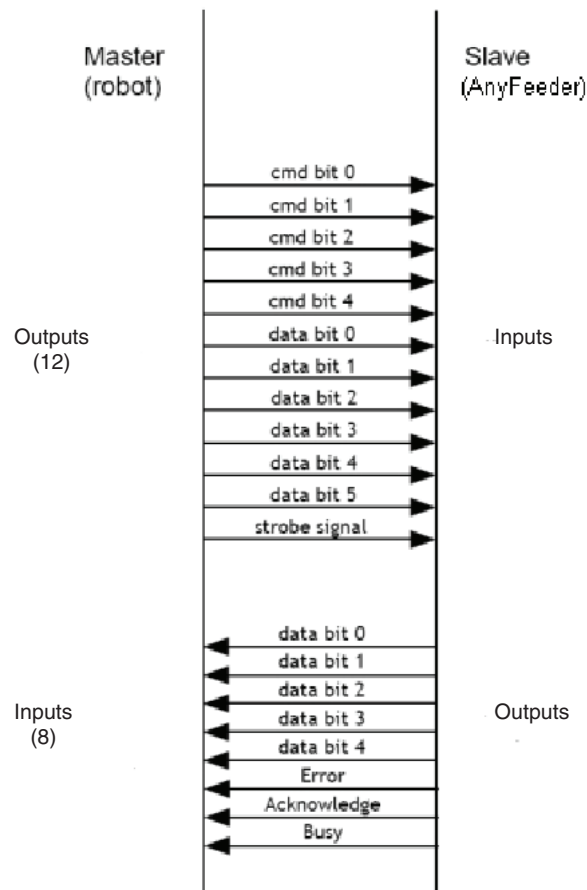

Figure 4-1. Digital Inputs and Outputs

The handshake for the command cycle works as follows:

1. Master outputs the binary representation of a command's decimal value to cmd bits 0 thru 4.
2. Master outputs the binary representation of a parameter's decimal value to data bit 0 through 5.
3. Master sets the STROBE signal to HIGH, to tell the Adept AnyFeeder that a valid command and parameter can be fetched from the corresponding Adept AnyFeeder input sets.
4. When the Adept AnyFeeder sees the STROBE go HIGH, it sets ACKNOWLEDGE and BUSY to HIGH and reads in the command and the parameter.
5. When the master sees ACKN go HIGH, it sets STROBE to LOW.
6. Upon completion of the command, the Adept AnyFeeder sets BUSY to LOW. If the command could not be completed successfully, the Adept AnyFeeder sets ERROR to HIGH and outputs an error code to data bits 0 through 4.

4.3 Commands and Parameters

Table 4-2. Commands and Parameters

cmd (Decimal Value)	cmd Description	param (Decimal Value)	param Description	Details
Action Commands				
1	feed-forward	1...64	feed-forward repetitions	Moves parts on feed plate forward.
2	feed-backward	1...64	feed-backward repetitions	Moves parts on feed plate backward.
3	feed-/flip-forward	1...64	feed-/flip-forward repetitions	Moves parts on feed plate forward and flips them at the same time.
4	feed-/flip-backward	1...64	feed-/flip-backward repetitions	Moves parts on feed plate backward and flips them at the same time.
5	flip	1...64	flip repetitions	Flips parts on the feed plate.
6	dispense	1...64	dispense repetitions	Dispenses parts from the bulk container onto the feed plate.
7	purge	1...64	purge repetitions	Feeds parts on the feed plate and in the bulk container backward.
14	turn off servo motors	-	-	Turns off both servo motors.
16	initialize	-	-	Must be sent prior to any other action command.

Table 4-2. Commands and Parameters

cmd (Decimal Value)	cmd Description	param (Decimal Value)	param Description	Details
30	reset error condition	-	-	Must be executed after feeder reports an error; feed plate and bulk container are moved to the home position.
31	restart feed firmware	-	-	Performs a 'soft' restart of feeder firmware.
Commands to Set Parameters				
17	set feed-forward speed	1...10	feed-forward speed	default = 1; 10 max.
18	set feed-backward speed	1...10	feed-backward speed	default = 1; 10 max.
19	set feed-/flip-forward speed	1...10	feed-/flip-forward intensity	default = 1; 10 max.
20	set feed-/flip-backward intensity	1...10	feed-/flip-backward intensity	default = 1; 10 max.
21	set flip intensity	1...10	flip intensity	default = 1; 10 max.
22	set dispense feed	1...10	dispense feed	default = 1; 10 max.
23	set purge speed	1...10	purge speed	default = 1; 10 max.

Maintenance 5

5.1 Introduction

This chapter describes:

- The periodic maintenance required for the Adept AnyFeeder
- The replacement procedure for the feed surface
- The adjustment procedure for the feed-deck height

5.2 Periodic Maintenance

Table 1 shows the periodic (routine) maintenance tasks required for the Adept AnyFeeder.

Table 1: Periodic Maintenance Tasks

Item	Description	Interval
Feed surface	Clean upper side of feed surface and frame with a non-abrasive, no-residue cleaner, such as rubbing alcohol or window cleaner. Failure to do this may degrade vision performance.	Weekly
Feed surface and support	Remove feed surface and clean bottom side with a non-abrasive, no-residue cleaner, such as rubbing alcohol or window cleaner. Clean support surface and glass window with alcohol. Failure to do this may degrade vision performance.	Monthly
Backlight	Remove side panel and clean upper side of backlight. Failure to do this may degrade vision performance.	Quarterly
Servo valve	Check the two plastic silencers that are screwed into the servo valve to see if they are blocked with oil. If needed, replace the silencers. Failure to do this may degrade AnyFeeder performance.	Annually

NOTE: Maintenance intervals may require adjustment based on environment and/or application conditions. If you are feeding dirty parts or if bulk parts contain debris, you may need to shorten the maintenance interval in order to maintain optimum performance of the equipment.

5.3 Removing and Installing the Feed Surface

The feed surface is subject to wear during normal system use and will need to be replaced periodically. To replace the feed surface:



WARNING: Follow proper lockout procedures before performing this service procedure. Failure to do so could result in injury.

1. Purge all parts from the Adept AnyFeeder.
2. Turn off the power and air supply to the Adept AnyFeeder.
3. Disconnect the I/O cable from the front of the Adept AnyFeeder.
4. Loosen the screws on the side rails.
5. Remove the feed surface by sliding it out of the rear end of the Adept AnyFeeder.
6. After the existing feed surface has been removed, clean all residue from the exposed feed deck. (See [Figure 5-1.](#))

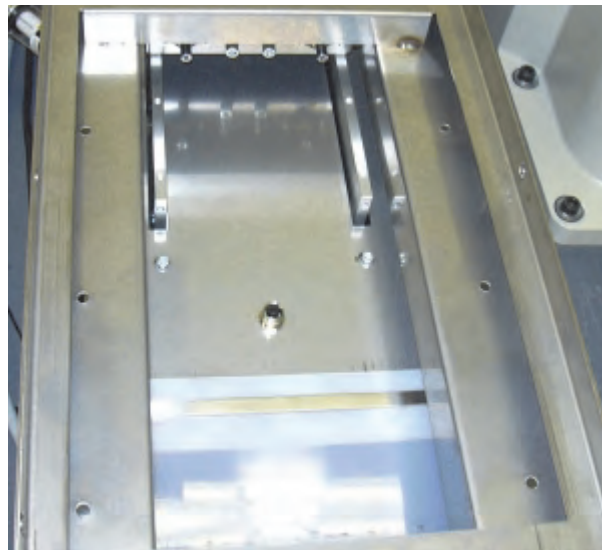

Figure 5-1. Feed Deck and Drive Block



CAUTION: Use only a non-abrasive, no-residue cleaner, such as rubbing alcohol or window cleaner applied to a clean shop towel. Do not spray cleaner directly onto the feed deck.

- a. Spray the cleaning product onto a clean shop towel.
 - b. Wipe the feed deck with the shop towel to remove any dirt or debris.
7. Unpackage the new feed surface. The feed surface is self-lubricating. Therefore, no lubricants should be applied to the feed surface.
 8. Slide the new feed surface into the feed deck.
 9. Re-tighten the screws on the side rails.
 10. Turn on the power and air supply to the Adept AnyFeeder.

Optional Equipment

6

6.1 Introduction

This chapter describes optional equipment that is available for the Adept AnyFeeder.

6.2 Backlight

This section describes the procedure for installing the backlight option on the Adept AnyFeeder. A red (P/N 05284-201) and an infrared (P/N 05284-202) backlight are available.

1. Slide out the feed surface from the back of the Adept AnyFeeder.
2. Use a 2.5 mm Allen wrench and 7 mm wrench or socket to remove the two screws from the feed platform front cover.

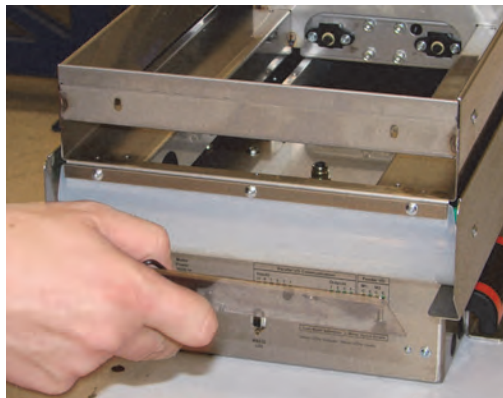

Figure 6-1. Removing the Feed Platform Front Cover

3. Insert the backlight power plug into the 4-pin connector in the Adept AnyFeeder's base housing. Screw in the plug to secure it in place. Make sure the plug is oriented toward the back of the Adept AnyFeeder, as shown in the following illustration.

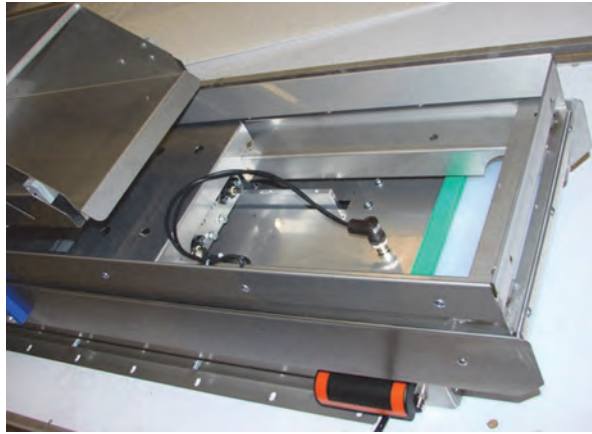

Figure 6-2. Backlight Power Plug Installed

4. Route the two small plugs of the backlight power cable through the front of the feed platform and connect them to two connectors on the back of the backlight.



Figure 6-3. Connection to Backlight

5. Slide the backlight through the front of the feed platform.
6. Use a 3 mm Allen wrench to install four screws at the corners of the backlight to secure it to the Adept AnyFeeder.

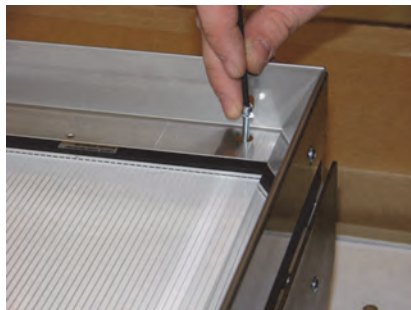

Figure 6-4. Securing Backlight to AnyFeeder

7. Reinsert the feed surface from the back of the Adept AnyFeeder and reinstall the feed platform front cover using two screws.

7

Dimension Drawings

7.1 Dimensions

This section provides the critical dimensions for the Adept AnyFeeder.

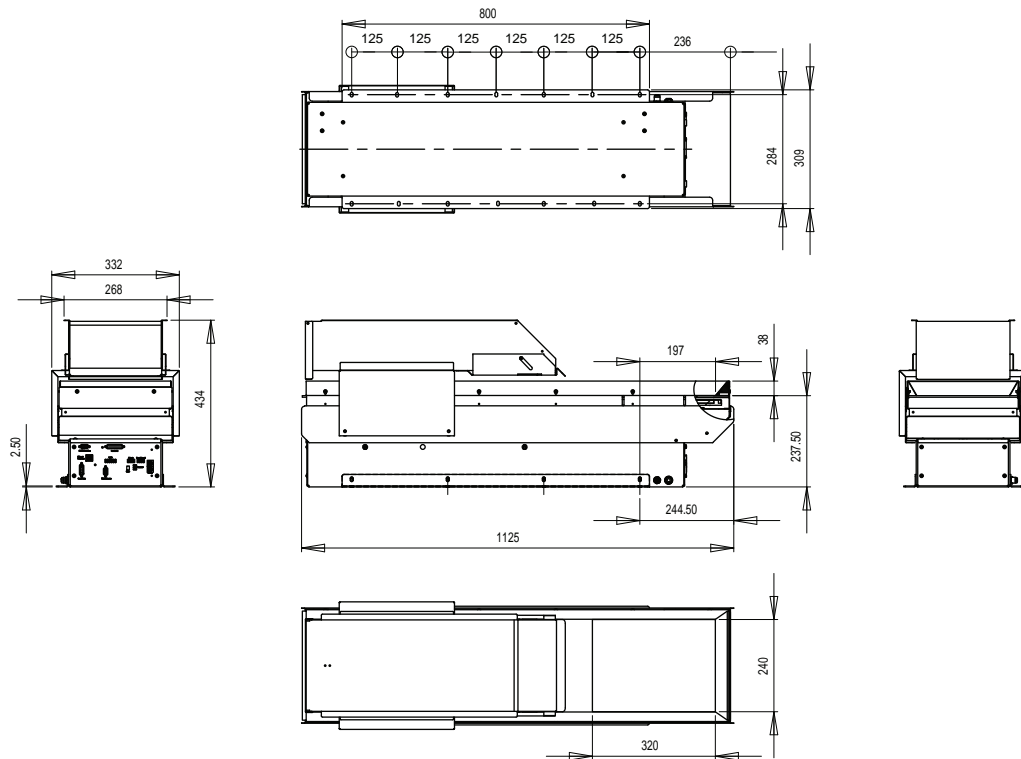

Figure 7-1. Adept AnyFeeder Dimensions

Controlling the AnyFeeder from V+

The Adept AnyFeeder can be controlled from a V+ program. This appendix provides an overview of that process. This feature requires AdeptSight version 3.1 or later.

NOTE: Although the Adept AnyFeeder can be controlled from a V+ program, Adept recommends that you use the graphical interface provided in the Adept ACE software. For details, see the [Adept ACE User's Guide](#).

A.1 Overview

When a V+ vision (AdeptSight) keyword is used in a V+ program, the corresponding function on the PC side checks the specified index:

- If the index corresponds to an AdeptSight vision sequence, it executes that sequence.
- If it corresponds to an Adept AnyFeeder, it executes control for the Adept AnyFeeder.

NOTE: The Adept AnyFeeder index can be set using the Adept AnyFeeder object editor in the Adept ACE software. For details on the AnyFeeder object editor, see the [Adept ACE User's Guide](#).



CAUTION: If an AdeptSight vision sequence *and* an Adept AnyFeeder have the same index value, only the AdeptSight vision sequence will be executed. This prevents any conflict with an existing AdeptSight vision system when adding an Adept AnyFeeder.

A.2 V+ Keywords

The following pages describe the V+ keywords in the AdeptSight software that can be used to control the Adept AnyFeeder. Each page provides the syntax and details for controlling the Adept AnyFeeder. For details on the AdeptSight software vision functionality of the keyword, see that keyword description in the [AdeptSight Reference Guide](#).

NOTE: This feature requires AdeptSight version 3.1 or later.

VPARAMETER program instruction

Description

Writes an Adept AnyFeeder parameter.

Syntax

VPARAMETER(anyfeeder.id, -1, parameter.id, -1, -1) \$ip = parameter.value

Parameters

anyfeeder.id	The AnyFeeder index specified in the Adept AnyFeeder object editor.
parameter.id	The code corresponding to the parameter to read or write. as shown in the following table.
\$ip	IP address of the PC to which the Adept AnyFeeder is connected.
parameter.value	The value of the parameter. If the specified value is outside of the allowed range, as specified in the following table, the command is ignored.

Table A-1. VPARAMETER Parameter Indexes

Parameter	Code	Value (Range)	Description
AnyFeederVRunCommand	6000	Value shown in Table A-2	Sets the AnyFeeder command that will be called on a VRUN. For more details, see Table A-2 .
AnyFeederFeedForwardSpeed	6001	0 to 10	Sets the speed for the feed-forward operation.
AnyFeederDispenseSpeed	6002	0 to 10	Sets the speed for the dispense operation.
AnyFeederFlipSpeed	6003	0 to 10	Sets the speed of the flip operation.
AnyFeederPurgeSpeed	6004	0 to 10	Sets the speed of the purge operation.
AnyFeederFeedBackwardSpeed	6005	0 to 10	Sets the speed of the feed-backward operation.
AnyFeederHeavyDispenseSpeed	6006	0 to 10	Sets the speed of the heavy-dispense operation.
AnyFeederFeedFlipForwardSpeed	6007	0 to 10	Sets the speed of the feed flip-forward operation.
AnyFeederFeedFlipBackwardSpeed	6008	0 to 10	Sets the speed of the feed flip-backward operation.
AnyFeederFeedForwardIterations	6011	1 to 63	Sets the number of iterations for feed forward.

Table A-1. VPARAMETER Parameter Indexes

Parameter	Code	Value (Range)	Description
AnyFeederDispenseIterations	6012	1 to 63	Sets the number of iterations for dispense.
AnyFeederFlipIterations	6013	1 to 63	Sets the number of iterations for flip.
AnyFeederPurgeIterations	6014	1 to 63	Sets the number of iterations for purge.
AnyFeederFeedBackwardIterations	6015	1 to 63	Sets the number of iterations for feed backward.
AnyFeederHeavyDispenseIterations	6016	1 to 63	Sets the number of iterations for heavy dispense.
AnyFeederFeedFlipForwardIterations	6017	1 to 63	Sets the number of iterations for feed flip forward.
AnyFeederFeedFlipBackwardIterations	6018	1 to 63	Sets the number of iterations for feed flip backward.

VRUN program instruction

Description

Initiates the specified operation of the Adept AnyFeeder.

Syntax

VRUN \$ip, anyfeeder.id

Parameters

\$ip	IP address of the PC to which the Adept AnyFeeder is connected.
anyfeeder.id	The AnyFeeder index specified in the Adept AnyFeeder object editor.

Operation and Values

The command codes correspond to the Adept AnyFeeder device command codes, with the exceptions of “100” and “101”, which do not follow this format.

Table A-2. AnyFeeder VRUN Command Operation and Values

Operation	Value
FeedForward	1
FeedBackward	2
FeedFlipForward	3
Flip	5
Dispense	6
Purge	7
HeavyDispense	8
Stop	15
Init	16
SetOutput	27
ErrorReset	30
FirmwareRestart	31
SwitchBacklightON	100
SwitchBacklightOFF	101

Details

The Adept AnyFeeder runs the command that was selected by the AnyFeederVRunCommand (6000) parameter (see [Table A-1](#)). VRUN returns after the Adept AnyFeeder operation starts or, eventually, on an Adept AnyFeeder error.

VWAITI program instruction

Description

Pauses program execution until the current Adept AnyFeeder operation has completed.

Syntax

VWAITI (anyfeeder.id) \$ip, type

Parameters

anyfeeder.id	The AnyFeeder index specified in the Adept AnyFeeder object editor.
\$ip	IP address of the PC to which the Adept AnyFeeder is connected.
type	0 Wait for full completion (default).

Details

Use VWAITI call after VRUN.

Contrary to vision sequences, when VWAITI is used with the Adept AnyFeeder, it always waits for full completion of the current Adept AnyFeeder operation. Therefore, the type parameter can be omitted.

VSTATE real-valued function

Description

Returns the Adept AnyFeeder status.

Syntax

VSTATE(\$ip, anyfeeder.id)

Parameters

\$ip	IP address of the PC to which the Adept AnyFeeder is connected.
anyfeeder.id	The AnyFeeder index specified in the Adept AnyFeeder object editor.

Details

The following table shows the possible returned values and corresponding Adept AnyFeeder status.

Table A-3. AnyFeeder Status and Returned Values

Status	Value
Idle	0
Running	1
Error	4

Example V+ Code

The following V+ code provides an example of implementing Adept AnyFeeder control through a V+ program. For proper functionality, this code would be used along with robot-control code and error-checking code to create a complete V+ application.

```

; Set parameter values
  $ip = "172.21.12.91"
  prm.ffwd.speed = 6001
  prm.ffwd.iter = 6011
  prm.run.action = 6000
  operation = 1
  anyfeeder.id = 3

; Set FeedForward speed
  VPARAMETER(anyfeeder.id, -1, prm.ffwd.speed, -1, -1) $ip = 1

; Set FeedForward iterations
  VPARAMETER(anyfeeder.id, -1, prm.ffwd.iter, -1, -1) $ip = 20

; Set the operation to be done at vrun : FeedForward
  VPARAMETER(anyfeeder.id, -1, prm.run.action, -1, -1) $ip = operation

; Check AnyFeeder is ready (idle)
  state = VSTATE($ip, anyfeeder.id)
  IF (state <> 0) THEN
    TYPE "Not ready, status = ", state
  END

; Start the feed operation
  VRUN $ip, anyfeeder.id

  TYPE "Start Waiting"

; Type status (running)
  TYPE "state = ", VSTATE($ip, anyfeeder.id)

; Wait completion
  VWAITI (anyfeeder.id) $ip

  TYPE "Finished Waiting"

  TYPE "state = ", VSTATE($ip, anyfeeder.id)

```

A

about your Adept AnyFeeder 11
Adept Document Library 17
assistance, Customer Service 16

B

backlight installation 53

C

cable installation 25
Cautions, Dangers, Warnings, and Notes 12
CD-ROM, document library 16
changing the Feed Forward repetitions 40
codes, command 33
command
 codes 33
 parameter default values 38
 setting parameters 34, 36–37
 speed of operation 36
 unknown 41
command, serial 33–34
commands
 joint 58, 60, 62
 UDT summary 57
communications, serial 32
connecting the power cable 28
Customer Service assistance 16

D

Dangers, Warnings, Cautions, and Notes 12
default values, command parameters 38
dimensions 55
Document Library, CD-ROM 16
drawings, dimension 55

E

electrical installation 25
emergency, what to do 16
emissions, sound 13
examples, serial communications dialogs 39

F

Feed Forward repetitions, changing 40
feed surface, removing and installing 50
Feed/Flip Forward, set and execute 40
feeding parts forward 39

flip drive has a servo problem 41

G

getting help 16

H

handles for lifting/moving the AnyFeeder 23
help, getting 16

I

I/O
 information 44
 power and servo 30
 power LEDs 30
initializing the AnyFeeder 39
installation
 backlight 53
 cables and power 25
 electrical 25
 feed surface 50
 mechanical 22
 pneumatic line 24
 verifying 30
introduction 11

J

joint
 commands 58, 60, 62

L

LEDs, I/O power and servo power 30
library, Adept Document 17
lifting the AnyFeeder, handles 23

M

maintenance 49
 backlight 49
 feed surface and channels 49
 servo valve 49
manuals, related 16
mechanical installation 22
message URL <http://www.adept.com> 16
mode switches 29
mounting location, preparing 22
moving the AnyFeeder

- handles 23
- mounting location 23

N

Notes, Dangers, Warnings, and Cautions 12

P

- parameters
 - command default values 38
 - setting serial port 32
- parts, feeding forward 39
- periodic maintenance 49
- pneumatic line, installation 24
- power cable, connecting 28
- power installation 25
- power LEDs 30
- programming 57
- protection, against unauthorized operation 15

Q

qualification of personnel 14

R

- removing
 - feed surface 50
 - packing material 20
- requirements, AnyFeeder system 31
- risks
 - due to incorrect installation or operation 16
 - that cannot be avoided 15
- routine maintenance 49

S

- safety
 - during maintenance 15
 - equipment for operators 15
 - risks that cannot be avoided 15
- sending commands to the AnyFeeder 33
- serial commands 33–34
 - syntax 33
- serial communications 32
 - dialog examples 39
- serial port, setting communication parameters 32
- servo power LEDs 30
- servo problem, flip drive 41
- setting
 - Feed/Flip Forward turns and execute 40
 - serial port communication parameters 32
 - switches 29
- sound emissions 13
- switches, setting 29

- syntax, serial commands 33
- system
 - I/O information 44
 - requirements 31

T

The 57

U

- UDT commands
 - joint 58, 60, 62
 - summary 57
- unknown command 41
- unpacking the AnyFeeder 20

V

- V+ programming 57, 63
- verifying the installation 30
- vision system 31
- VSTATE 62
- VWAITI 61

W

- Warnings, Dangers, Cautions, and Notes 12
- what to do in an emergency 16
- working areas, safety issues 13

P/N: 05284-002, Rev. B

adept[®]
5960 Inglewood Drive
Pleasanton, CA 94588
925-245-3400