

# **K3NX Process Meter**

## **Operation Manual**

*Cat. No. N90-E3-1*





## Notice:

OMRON products are manufactured for use according to proper procedures by a qualified operator and only for the purposes described in this manual.

The following conventions are used to indicate and classify precautions in this manual. Always heed the information provided with them. Failure to heed precautions can result in injury to people or damage to the product.

 **DANGER** Indicates information that, if not heeded, is likely to result in loss of life or serious injury.

 **WARNING** Indicates information that, if not heeded, could possibly result in loss of life or serious injury.

 **Caution** Indicates information that, if not heeded, could result in relatively serious or minor injury, damage to the product, or faulty operation.

## OMRON Product References

All OMRON products are capitalized in this manual. The word “Unit” is also capitalized when it refers to an OMRON product, regardless of whether or not it appears in the proper name of the product.

The abbreviation “Ch,” which appears in some displays and on some OMRON products, often means “word” and is abbreviated “Wd” in documentation in this sense.

The abbreviation “PC” means Programmable Controller and is not used as an abbreviation for anything else.

## Visual Aids

The following headings appear in the left column of the manual to help you locate different types of information.

**Note** Indicates information of particular interest for efficient and convenient operation of the product.

**1, 2, 3...** 1. Indicates lists of one sort or another, such as procedures, checklists, etc.

## © OMRON, 1998

All rights reserved. No part of this publication may be reproduced, stored in a retrieval system, or transmitted, in any form, or by any means, mechanical, electronic, photocopying, recording, or otherwise, without the prior written permission of OMRON.

No patent liability is assumed with respect to the use of the information contained herein. Moreover, because OMRON is constantly striving to improve its high-quality products, the information contained in this manual is subject to change without notice. Every precaution has been taken in the preparation of this manual. Nevertheless, OMRON assumes no responsibility for errors or omissions. Neither is any liability assumed for damages resulting from the use of the information contained in this publication.



# TABLE OF CONTENTS

<b>PRECAUTIONS</b> .....	<b>xi</b>
1 General Precautions .....	xii
2 Safety Precautions .....	xii
3 Application Precautions .....	xii
4 Noise Prevention .....	xiii
<b>SECTION 1</b>	
<b>Introduction</b> .....	<b>1</b>
1-1 Features .....	2
1-2 Front of the Meter .....	3
1-3 Rear of the Meter .....	6
1-4 Modes .....	7
1-5 Communications Function .....	8
1-6 Field Calibration .....	8
<b>SECTION 2</b>	
<b>Setup</b> .....	<b>9</b>
2-1 Mounting .....	10
2-2 Base Unit .....	11
2-3 Output Board .....	14
<b>SECTION 3</b>	
<b>Parameter Setting</b> .....	<b>19</b>
3-1 Overview .....	20
3-2 Setting Mode .....	21
3-3 Protect Mode .....	56
<b>SECTION 4</b>	
<b>Operations in RUN Mode</b> .....	<b>67</b>
4-1 Forced-zero .....	68
4-2 Displaying and Changing Setting Values .....	69
4-3 Displaying and Resetting of Maximum and Minimum Values .....	72
4-4 External Input Signals .....	73
<b>SECTION 5</b>	
<b>Useful Functions</b> .....	<b>75</b>
5-1 Teaching Function .....	76
5-2 Output Test .....	79
5-3 Maintenance Mode .....	80
<b>SECTION 6</b>	
<b>BCD Output</b> .....	<b>85</b>
6-1 Connectors .....	86
6-2 Timing Charts .....	89
<b>SECTION 7</b>	
<b>Troubleshooting</b> .....	<b>91</b>
7-1 Items to Be Checked First .....	92
7-2 Display .....	92

# TABLE OF CONTENTS

## Appendices

A Specifications .....	95
B List of Settings .....	99
C Available Models .....	101
D Available Parameters .....	103
E Setting Examples .....	105
<b>Index .....</b>	<b>109</b>
<b>Revision History .....</b>	<b>113</b>

## ***About this Manual:***

This manual describes the installation and operation of the K3NX Process Meter and includes the sections described below.

Please read this manual carefully and be sure you understand the information provided before attempting to install and operate the K3NX.

**Section 1** describes the functions of the K3NX. The main components are also described.

**Section 2** provides instructions required for mounting and wiring the K3NX.

**Section 3** provides instructions for setting the parameters of the K3NX.

**Section 4** provides instructions for operating the K3NX in RUN mode.

**Section 5** provides information on the teaching function, output test, and maintenance mode.

**Section 6** provides information on the use of the K3NX with the BCD Output Board.

**Section 7** provides information for troubleshooting the K3NX

The **Appendices** provide specifications, a list of settings, a list of standard models, and a list of available menu items.



### **WARNING**

Failure to read and understand the information provided in this manual may result in personal injury or death, damage to the product, or product failure. Please read each section in its entirety and be sure you understand the information provided in the section and related sections before attempting any of the procedures or operations given.

# PRECAUTIONS

This section provides precautions for using the K3NX Process Meter and related devices.

**The information contained in this section is important for the safe and reliable application of the K3NX. You must read this section and understand the information contained before attempting to set up or operate the K3NX.**

1 General Precautions .....	xii
2 Safety Precautions .....	xii
3 Application Precautions .....	xii
4 Noise Prevention .....	xiii



## 2 General Precautions

The user must operate the product according to the performance specifications described in the operation manuals.

Before using the product under conditions which are not described in the manual or applying the product to nuclear control systems, railroad systems, aviation systems, vehicles, combustion systems, medical equipment, amusement machines, safety equipment, and other systems, machines, and equipment that may have a serious influence on lives and property if used improperly, consult your OMRON representative.

Be sure to read this manual before attempting to use the product and keep this manual close at hand for reference during operation.

## 3 Safety Precautions

 **WARNING** Never attempt to disassemble any Units while power is being supplied. Doing so may result in serious electrical shock or electrocution.

 **WARNING** Never touch any of the terminals while power is being supplied. Doing so may result in serious electrical shock or electrocution.

## 4 Application Precautions

Observe the following precautions when using the product.

- Always use the power supply voltage specified in the specifications.
- Do not use the product in locations subject to flammable gases or combustible objects.
- Be sure to confirm terminal names when wiring.
- Be sure to tighten the screws on the terminal blocks.

Observe the following precautions when mounting the product.

- Mount the product on level surfaces.
- Mount the product on a panel which has a thickness of 1 to 3.2 mm.

Do not mount the product in the following places.

- Locations subject to strong shock or vibration.
- Locations subject to temperature or humidity exceeding the rated levels or where icing is liable to occur.
- Locations subject to dust.
- Locations subject to corrosive gases (particularly sulfuric gases or ammonium gases).
- Locations subject to direct sunlight or outdoor conditions.
- Locations near devices (high-frequency welders or high-frequency sewing machines) that produce high-frequency noise.

# 5 Noise Prevention

Provide the following countermeasures when using the product in an environment where the product is exposed to noise.

- Countermeasures for protecting the product against high-frequency noise or abnormal voltages.

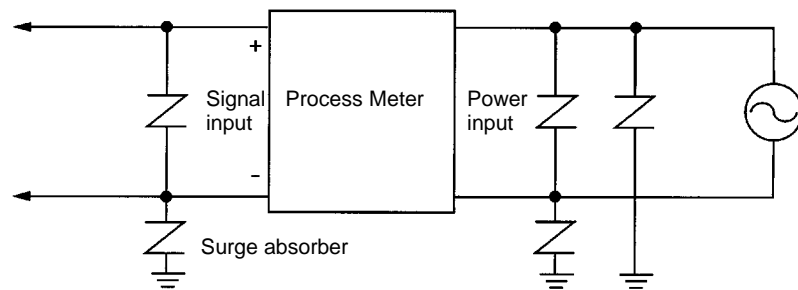
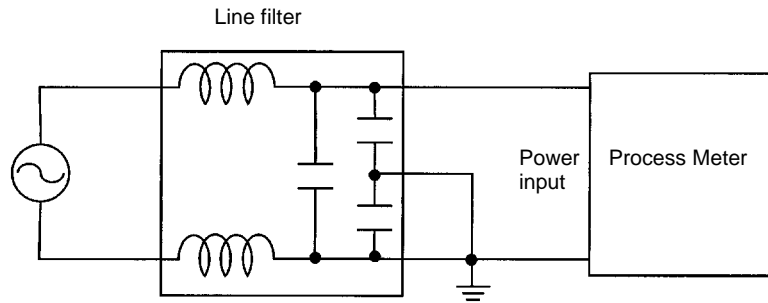

- Countermeasures for protecting the product against inductive noise produced from the input line.

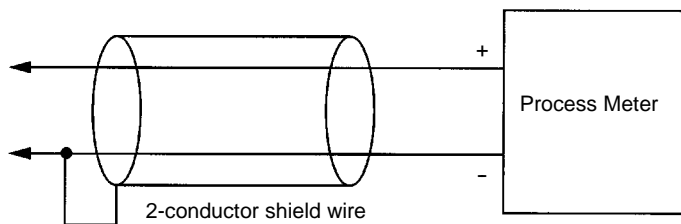

# SECTION 1

## Introduction

This section describes the functions of the K3NX. The main components are also described. Refer to the remaining sections of this manual for the operation of the K3NX and its menus in detail.

1-1	Features .....	2
1-2	Front of the Meter .....	3
1-3	Rear of the Meter .....	6
1-4	Modes .....	7
1-5	Communications Function .....	8
1-6	Field Calibration .....	8

## 1-1 Features

The K3NX Process Meter displays voltage or current input after performing the numeric conversion of the input.

The K3NX has the following functions.

### Scaling

Current or voltage input is converted into a value within a specified range to display engineering units.

There are two scaling methods: scaling by using measured input values or scaling without connecting a sensor and using assumed input values instead.

Refer to *3-2-4 Scaling Menu*.

### Comparative Output Selection

Comparison output patterns can be selected from the standard, level, or zone output depending on the application.

Refer to *Comparative Output Patterns*, page 48.

### Linear Output

Refer to *Linear Output Range*, page 51.

### BCD Output

A digital data output format where every four binary bits is numerically equivalent to one decimal digit.

Refer to *Section 6 BCD Output*.

### Communications Output

Refer to the *Communications Manual*.

### HOLD

HOLD is an external input which is used to stop the A/D process and freeze the display. The comparative, linear, and BCD outputs are also retained.

Refer to *4-4 External Input Signals* for details.

### RESET

RESET is an external input to reset the present maximum and minimum values. The process value when the RESET is ON is set as the maximum and minimum values. The maximum and minimum values can be reset using the front panel keys.

Refer to *4-3 Displaying and Resetting of Maximum and Minimum Values*.

### Teaching

The K3NX is provided with a teaching function that can set an actual measured value as a setting value without key input.

This function is useful for setting parameters while checking the operating status of the K3NX.

The teaching function can be used to set the set and scaling values. It can be also used to set the linear output range of the K3NX with a Linear Output Board.

Refer to *5-1 Teaching Function* for details.

### Output Test

This function is convenient for checking a system to which the K3NX is connected, especially when some inputs cannot be operated. The K3NX simulates an input to check the output conditions.

Refer to *5-2 Output Test* for details.

### Forced-zero

By turning the ZERO input ON, the process value can be calibrated to zero.

This function is useful for measurement on the basis of any process value as zero.

This calibration is maintained without being influenced by input range changes or power interruptions until the next time the ZERO input signal is turned ON or the scaling value is changed.

Refer to *4-1 Forced-zero* for details.

- Hysteresis** The established setting value includes a hysteresis setting to prevent “chattering” of the output when the measured value fluctuates in the vicinity of the setting values.  
 Hysteresis is enabled when the measured value is starts to become smaller than the HH and H setting values and larger than the LL and L setting values.  
 Refer to *Hysteresis*, page 46.
- Startup Compensation Time** The startup compensation time parameter keeps the measurement operation from sending an unnecessary output corresponding to instantaneous, fluctuating input from the moment the K3NX is turned ON until the end of the preset period.  
 Refer to *Startup Compensation Time*, page 44.
- Remote/Local Selection** The K3NX can be operated remotely through a host computer or locally with key inputs.  
 Remote Mode: For programming remotely by downloading setup parameters from a host computer via RS-232C, RS-485, or RS-422.  
 Local Mode: Programming is performed with the front panel key input.  
 Refer to *Remote/Local Programming*, page 54.
- Average Processing** Average processing prevents the display from fluctuating due to unstable input. Simple average processing or movement average processing can be selected.  
 Refer to *Average Processing*, page 41.

## 1-2 Front of the Meter

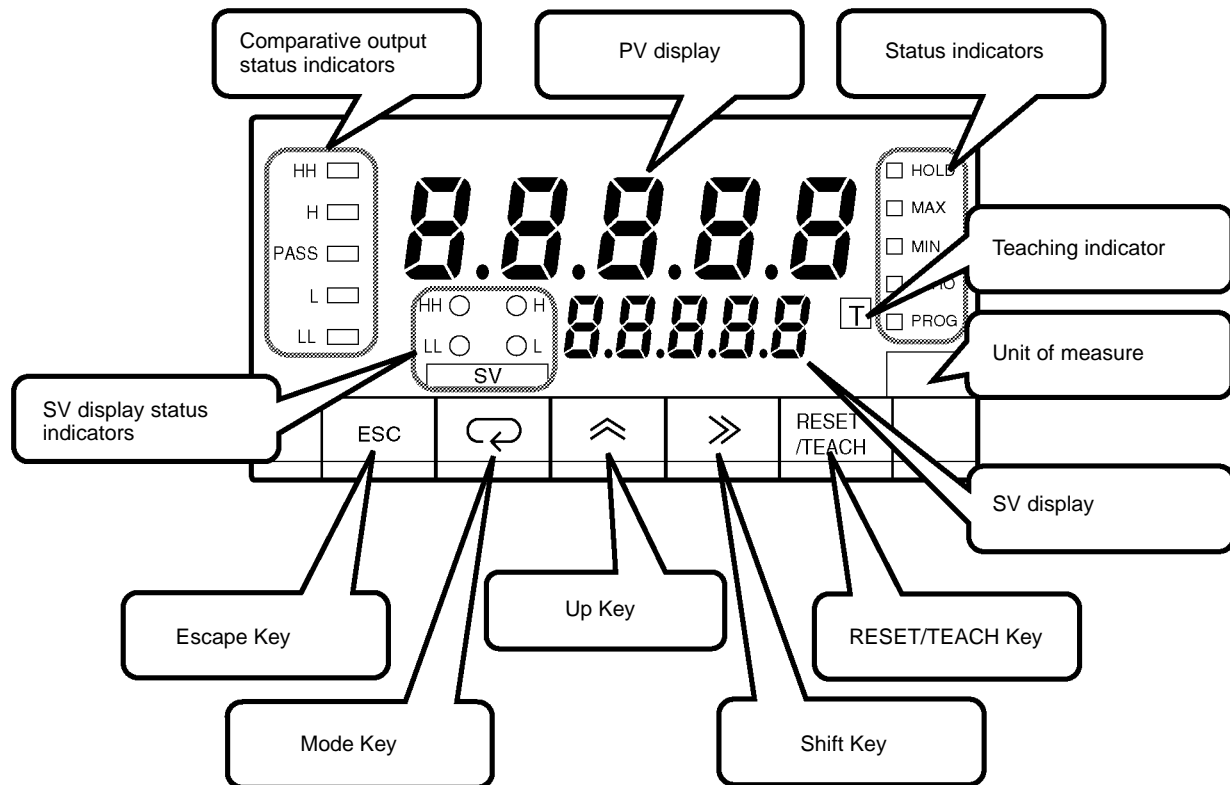

Five-digit (-19999 to 99999), seven-segment, 14.2-mm-high LED display with a programmable decimal point.  
 The displays show the process value, maximum value, minimum value, operations/parameters when setting, and error messages.

**PV Display**

**K3NX-□□□A Basic Model**

**RUN Mode:** Displays the process, maximum, and minimum values. Also displays setting values while the SV indicator is lit. When changing a value, all digits other than those that can be set become dimmer.

**Setting Mode:** Displays the menu, parameter, or setting value. When changing a value, all digits other than those that can be set become dimmer.

**K3NX-□□□C Set Value LED Display Model**

**RUN Mode:** Displays the process, maximum, and minimum values.

**Setting Mode:** Displays the menu and parameters.

**SV Display (Setting value LED Display Models Only)**

**RUN Mode:** Displays comparative setting values. When changing a value, all digits other than those that can be set become dimmer.

**Setting Mode:** Displays setting values. When changing a value, all digits other than those that can be set become dimmer.

**Comparative Output Status Indicators**

Indicates the status of the comparative output.

**Status Indicators**

**HOLD Indicator**

Lit when the HOLD input signal is ON.

**MAX Indicator**

Lit when the value displayed on the PV display is the maximum value.

**MIN Indicator**

Lit when the value displayed on the PV display is the minimum value.

**ZERO Indicator**

Lit when the ZERO input signal is ON.

**PROG Indicator**

Lit when the setting mode menu is displayed. The indicator flashes while parameters are displayed.

**Teaching Indicator**

Lit when displayed parameters can be set in teaching operation. The indicator flashes when the process value is indicated as a setting value.

**SV Display Status Indicators**

Indicates which set value is on the PV or SV display.

**Unit of Measure**

Attach the appropriate label showing the unit of measure (enclosed).

**Escape Key**

Used to select the process, maximum, or minimum value to be displayed on the PV display in RUN mode.

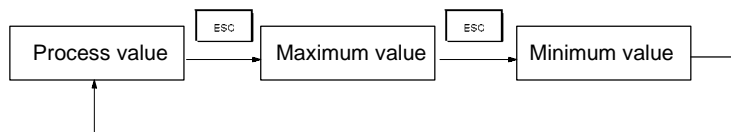

Used to return from the setting, protect, or maintenance mode to the RUN mode. This key is also used to return to the previous operation during the setting, protect, or maintenance mode.

**Mode Key**



Displays a setting value (out of HH, H, L, and LL setting values in this order) on the PV display in RUN mode when this key is pressed. Unless another operation key is pressed within five seconds after this key has been pressed, the display automatically changes to the one for process values.

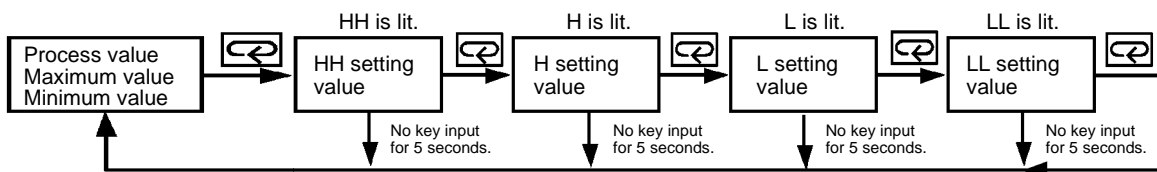

In the RUN mode, this button terminates the measurement process and allows you to enter the setting mode, advancing through the menus and parameters.

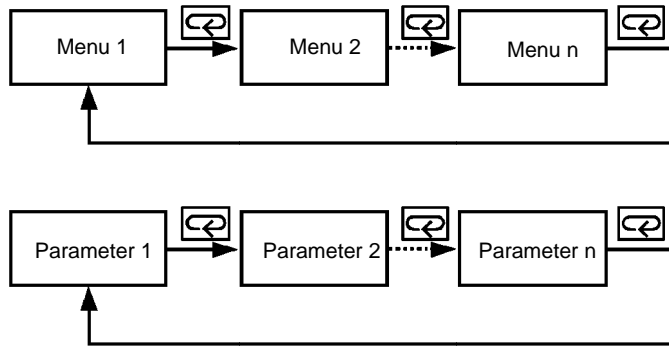

In the setting mode, this button will store changes in the non-volatile memory while at the same time advancing the display to the next menu item.

**Up Key**



Used to select a parameter to be displayed for setting value change.  
Used to increment the current digit in the setting value by one.

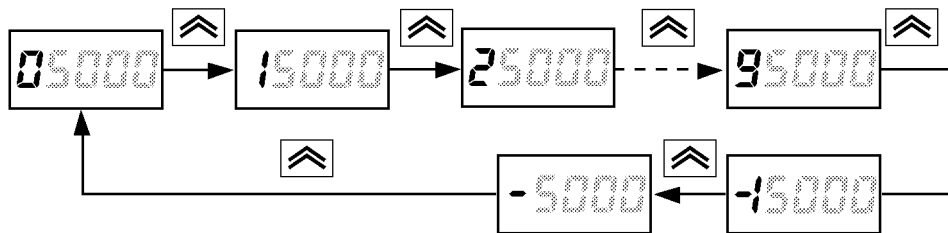

The value increases in the following order:  
0, 1, 2, 3, 4, 5, 6, 7, 8, 9, (-1), and (-)

Only the leftmost digit will be displayed if the value is set to “-1” or “-.”  
The value will be set to 0 if this key is pressed when “9” or “-” is displayed.

**Shift Key**



Used to change the parameter displayed in setting mode.  
Used to scroll the digit to the right of the presently displayed digit.

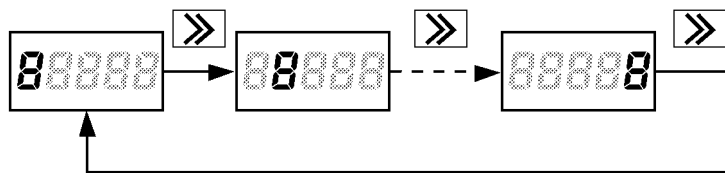

**RESET/TEACH Key**



Used to set the process value forcibly to “0” or reset the maximum/minimum value in RUN mode.

Used to select the teaching function. Refer to 5-1 Teaching Function for details.

### 1-3 Rear of the Meter

Terminal arrangement varies depending on the selected Output Board.  
For wiring, refer to *Section 2 Setup*.

- K3NX with Relay Output Board, K31-C1, -C2, -C5
- K3NX with Transistor Output Board, K31-T1, -T2
- K3NX with Linear Output Board, K31-L1, -L2, -L3, -L4, -L5, -L6, -L7, -L8, -L9, -L10
- K3NX with RS-485 Output Board, K31-FLK2, -FLK5

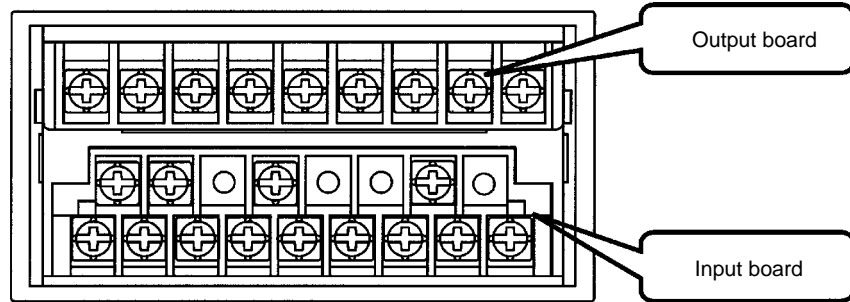

K3NX with BCD Output Board, K31-B2, -B4

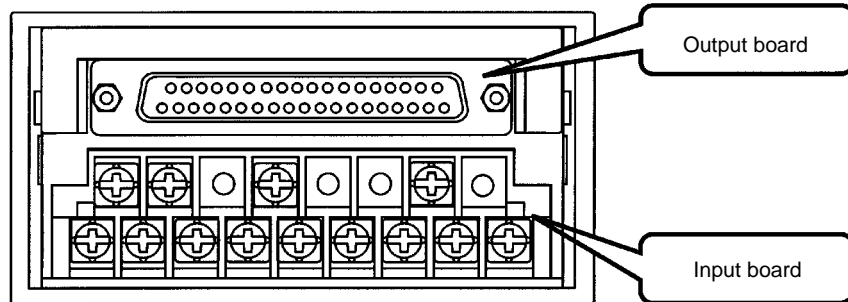

K3NX with RS-232C Output Board, K31-FLK1

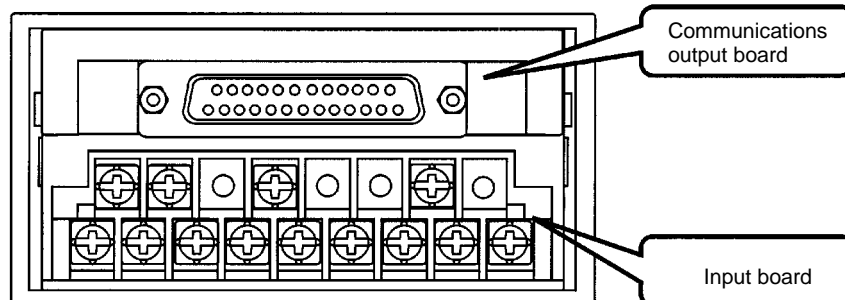



**K3NX with RS-422 Output Board, K31-FLK3**

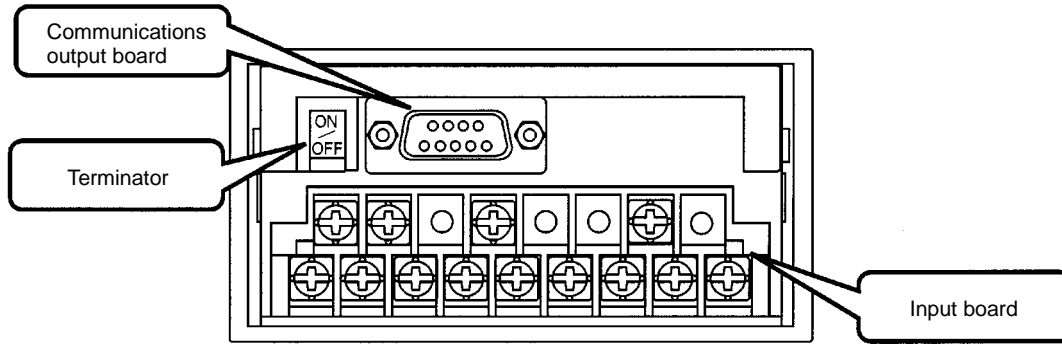

**K3NX with RS232C + Transistor Output Board, K31-FLK4**  
**K3NX with RS-422 + Transistor Output Board, K31-FLK6**

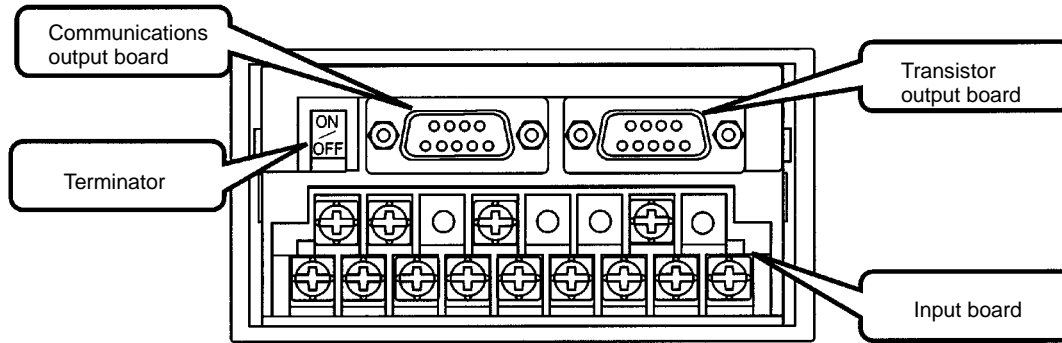

**1-4 Modes**

The following four modes are available.

- RUN mode for normal operations (see *Section 4 Operations in RUN Mode*)
- Setting mode for initializing parameter input (see *Section 3 Parameter Setting*)
- Protect mode for lock-out configuration (see *3-1 Protect Mode*)
- Maintenance mode for user-calibration and initialization (see *5-3-3 Field Calibration* and *5-3-2 Initialization*)

Refer to the following for the relationship among these modes and selection of the modes.

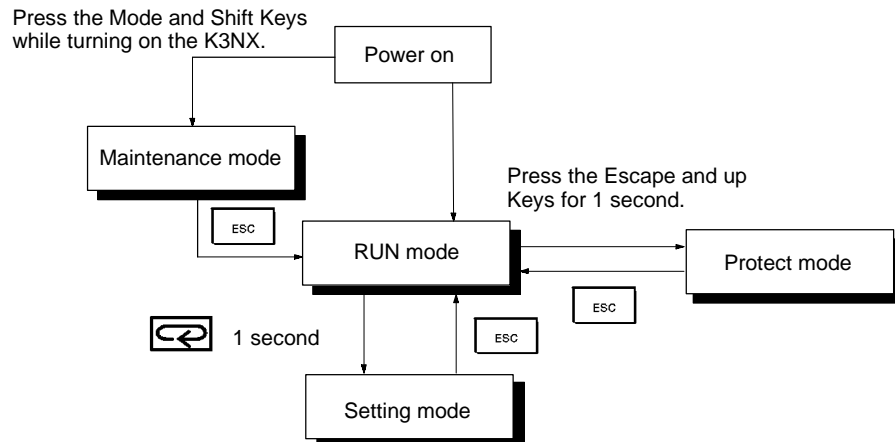

**RUN Mode**

K3NX is in RUN when the K3NX is turned ON.

The K3NX in this mode provides an output signal as a result of the comparison of the measured and setting values.

The basic model in this mode usually displays the process value. The maximum and minimum values are displayed by pressing the Escape Key. The parameters and setting values are displayed by pressing the Mode Key.

Refer to *Section 4 Operations in RUN Mode* for RUN mode in detail.

**Setting Mode**

Values are set in the K3NX in this mode by key input or using the teaching function.

Refer to *Section 3 Parameter Setting* for value setting by key input and *5-1 Teaching Function* for the teaching function in detail.

**Protect Mode**

Use this mode to prohibit some operations in order to lock out the setting values.

Refer to *3-1 Protect Mode* for details.

**Maintenance Mode**

The field calibration of the K3NX in this mode is possible. Refer to *5-3-3 Field Calibration* for details.

The setting values are reset to factory-set values in this mode. Refer to *5-3-2 Initialization* for details.

## 1-5 Communications Function

The communications function of the K3NX makes it possible for the host computer to perform the following operations.

- Confirmation and change of setting values. Communications conditions cannot be changed.
- Reading and resetting the maximum and minimum values.
- Forced-zero setting and resetting.
- Confirmation of model data.

Use a model with the Communications Board if the communications function is required.

Refer to the *Communications Manual* for the communications function in detail.

**RS-232C**

Use the K31-FLK1 or K31-FLK4 Output Board to use the RS-232C interface.

**RS-422**

Use the K31-FLK3 or K31-FLK6 Output Board to use the RS-422 interface.

**RS-485**

Use the K31-FLK2 or K31-FLK5 Output Board to use the RS-485 interface.

## 1-6 Field Calibration

The K3NX is correctly calibrated before shipping. Normally, therefore, the user will not need to calibrate the K3NX.

The user can calibrate the K3NX by referring to *5-3 Maintenance Mode*. OMRON does not, however, guarantee the result of calibration performed by the user.

The user should prepare calibration instruments or equipment. Before operating such instruments or equipment, be sure to read the operation manuals provided with them.

# SECTION 2

## Setup

This section provides instructions required for mounting and wiring the K3NX.

2-1	Mounting .....	10
2-2	Base Unit .....	11
2-2-1	Terminal Arrangement .....	11
2-2-2	Wiring Precautions .....	12
2-2-3	Wiring .....	12
2-3	Output Board .....	14
2-3-1	Terminal Arrangement .....	14
2-3-2	Relay Output Board .....	16
2-3-3	Transistor and Combination Output Board .....	17
2-3-4	Linear Output Board .....	17
2-3-5	BCD Output Board .....	17

## 2-1 Mounting

### Dimensions

All dimensions are in millimeters.

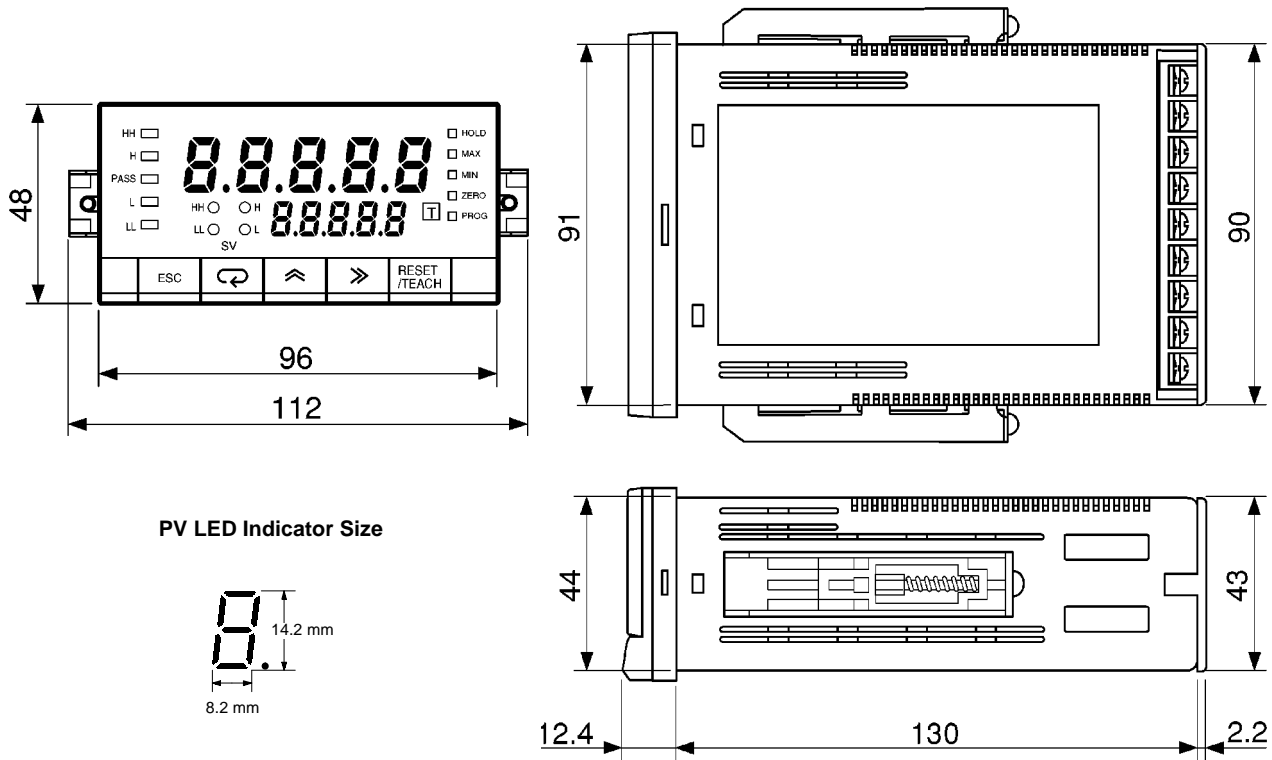

### Panel Cutouts

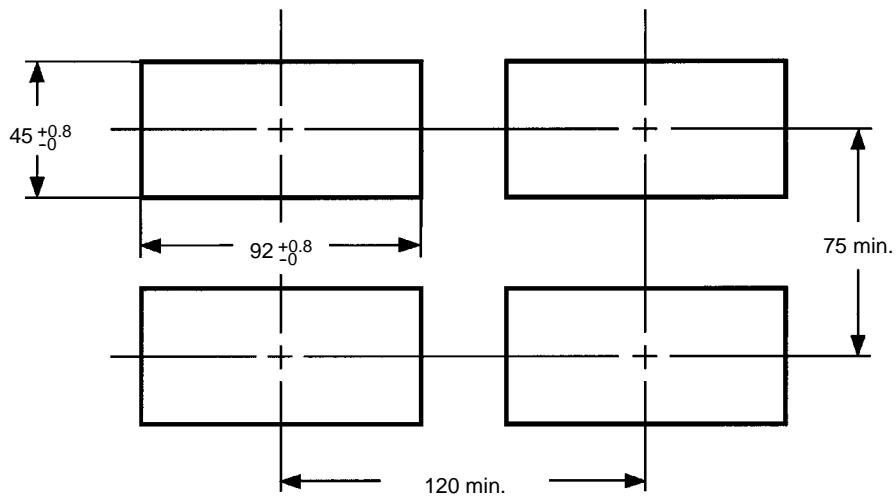

Recommended panel thickness is 1 to 3.2 mm.

Do not mount more than one Unit closely in the horizontal or vertical direction. Be sure to keep the distance between adjacent Units.

Mounting Method

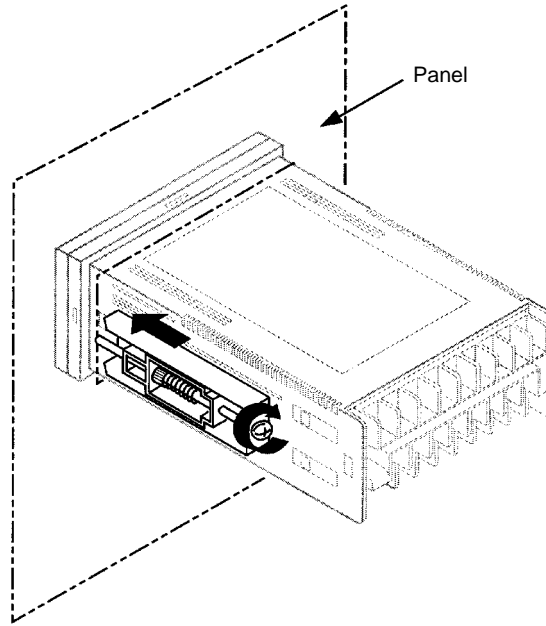

- 1, 2, 3...
1. Insert the K3NX into the mounting hole on the panel.
  2. Hook the fixture claws onto the side holes.
  3. Mount a fixing metal to the right and left sides as shown above and while keeping them in balance, alternately tighten each screw until the ratchet becomes idle.

## 2-2 Base Unit

### 2-2-1 Terminal Arrangement

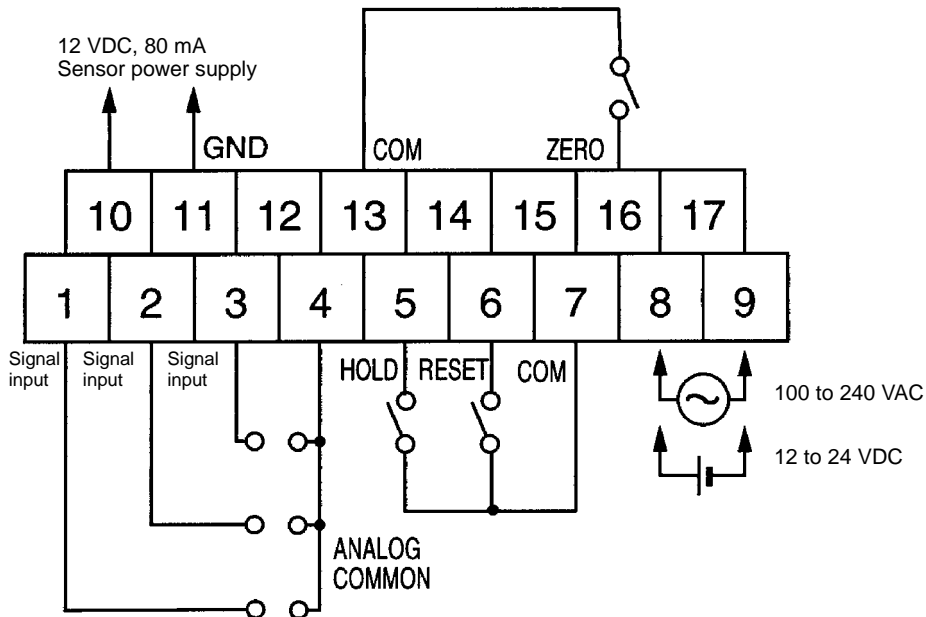

**Note** Terminals 7 to 13 are connected internally.

## 2-2-2 Wiring Precautions

- Do not make any mistake in polarity when supplying DC power to the K3NX.
- Do not wire power lines alongside the signal lines of the K3NX in order to prevent the K3NX from noise interference.
- Wire the terminal block with crimp terminals.
- Tighten the terminal screws to the torque of approx. 0.78 N • m (8 kgf • cm).

## 2-2-3 Wiring

### Power Supply

Apply 100 to 240 VAC or 12 to 24 VDC to terminals 8 and 9.

### Signal Input

Connect measurement inputs to terminals 1, 2, or 3, and to terminal 4.

The terminals used vary with the input range as shown in the following table.

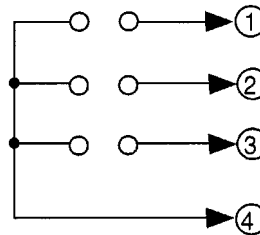

Input type	Input range	Measurement range	Input terminals
DC voltage input	$R_{\omega d}$	-199.99 to 199.99 V	1 and 4
	$b_{\omega d}$	-19.999 to 19.999 V	2 and 4
	$C_{\omega d}$	-1.9999 to 1.9999 V	3 and 4
	$d_{\omega d}$	-199.99 to 199.99 mV	3 and 4
	$E_{\omega d}$	1.0000 to 5.0000 V	2 and 4
DC current input	$R_{Rd}$	-199.99 to 199.99 mA	1 and 4
	$b_{Rd}$	-19.999 to 19.999 mA	2 and 4
	$C_{Rd}$	-1.9999 to 1.9999 mA	3 and 4
	$d_{Rd}$	4.000 to 20.000 mA	2 and 4
AC voltage input	$R_{\omega R}$	0.0 to 400.0 V	1 and 4
	$b_{\omega R}$	0.00 to 199.99 V	1 and 4
	$C_{\omega R}$	0.000 to 19.999 V	2 and 4
	$d_{\omega R}$	0.0000 to 1.9999 V	3 and 4
AC current input	$R_{RR}$	0.000 to 10.000 A	1 and 4
	$b_{RR}$	0.0000 to 1.9999 A	1 and 4
	$C_{RR}$	0.00 to 199.99 mA	2 and 4
	$d_{RR}$	0.000 to 19.999 mA	3 and 4

### Sensor Power Supply

A rated output current of 80 mA at 12 VDC.

Terminal 4 (ANALOG COMMON) and terminal 11 (GND) are insulated from each other.

## External Control Input

**HOLD Input**  
**RESET Input**  
**ZERO Input**

Connect external signal input to terminals 5, 6, 7, 13, and 16. Terminals 7 and 13 are connected to each other internally.

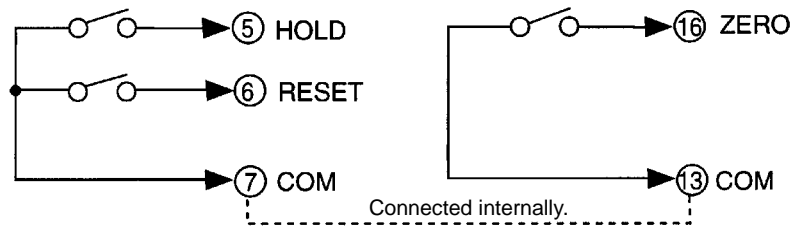

Connect hold signal (HOLD) input to terminal 5.

Connect reset signal (RESET) input to terminal 6.

Connect forced-zero signal (ZERO) input to terminal 16.

The transistor satisfying the following conditions must be used to input open collector external signals.

- Residual voltage with transistor turned on: 3 V max.
- Current leakage with transistor turned off: 1.5 mA max.
- Switching load current: 20 mA or greater.

Approximately 5 V is imposed between COM and terminals 5 to 7 with a current flow of approximately 18 mA (a nominal value) at the time of external input short-circuiting.

## 2-3 Output Board

### 2-3-1 Terminal Arrangement

K3NX with Relay Output Board, K31-C1, -C2, -C5  
 K3NX with Transistor Output Board, K31-T1, -T2  
 K3NX with Linear Output Board, K31-L1, -L2, -L3, -L4, -L5, -L6, -L7, -L8, -L9, -L10  
 K3NX with RS-485 Output Board, K31-FLK2, -FLK5

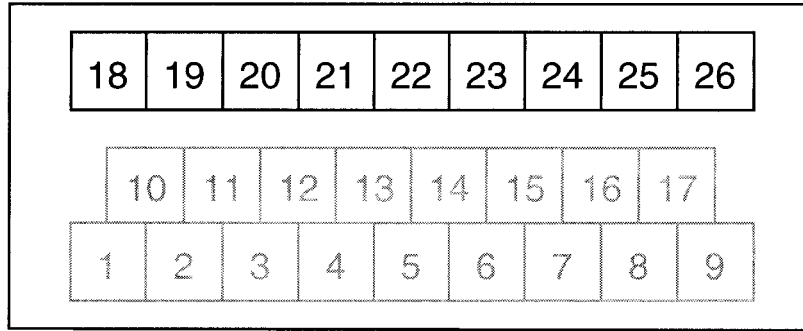

K3NX with BCD Output Board, K31-B2, -B4

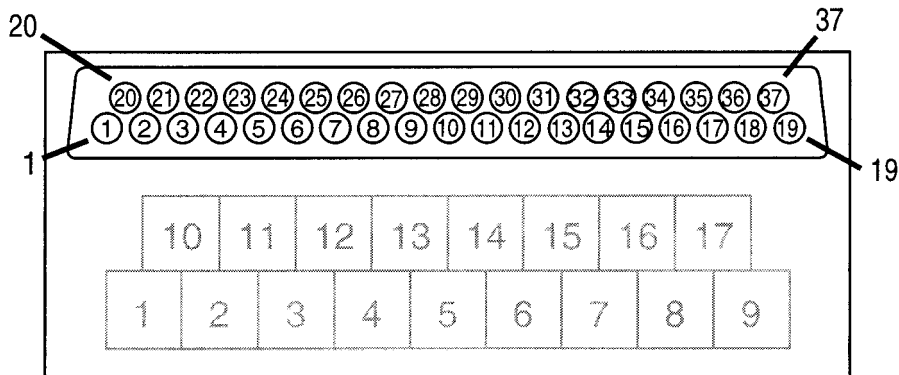

K3NX with RS232C + Transistor Output Board, K31-FLK4

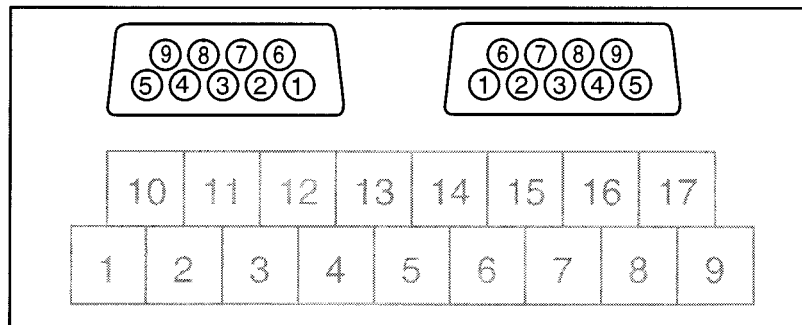



K3NX with RS-422 + Transistor Output Board, K31-FLK6

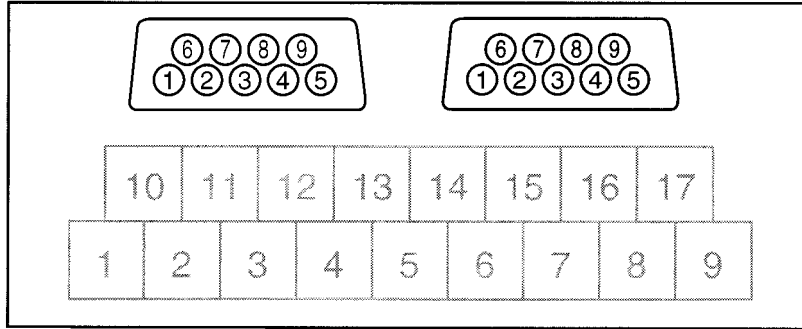

K3NX with RS-232C Output Board, K31-FLK1

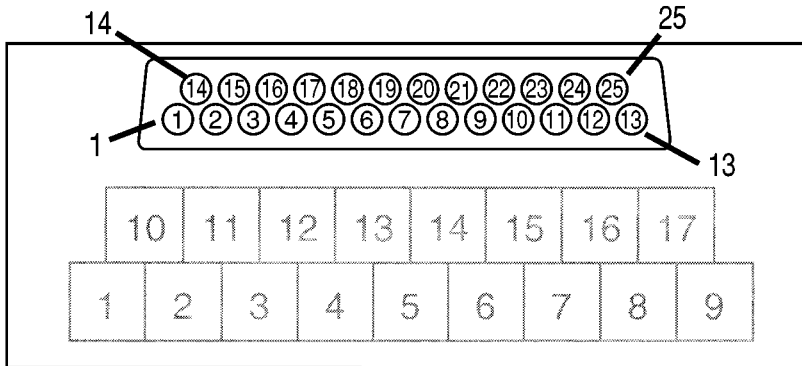

K3NX with RS-422 Output Board, K31-FLK3

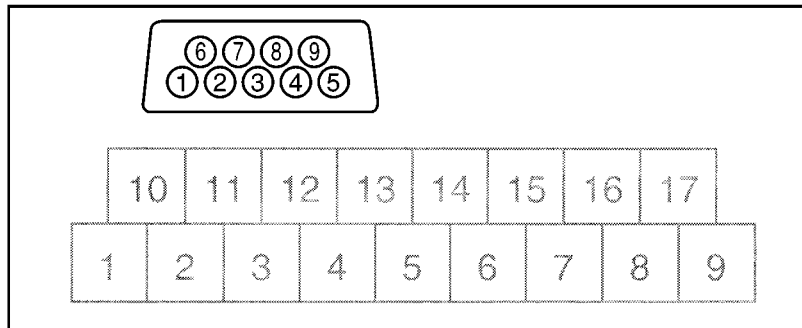

### 2-3-2 Relay Output Board

The following figures show the connections for relay output.

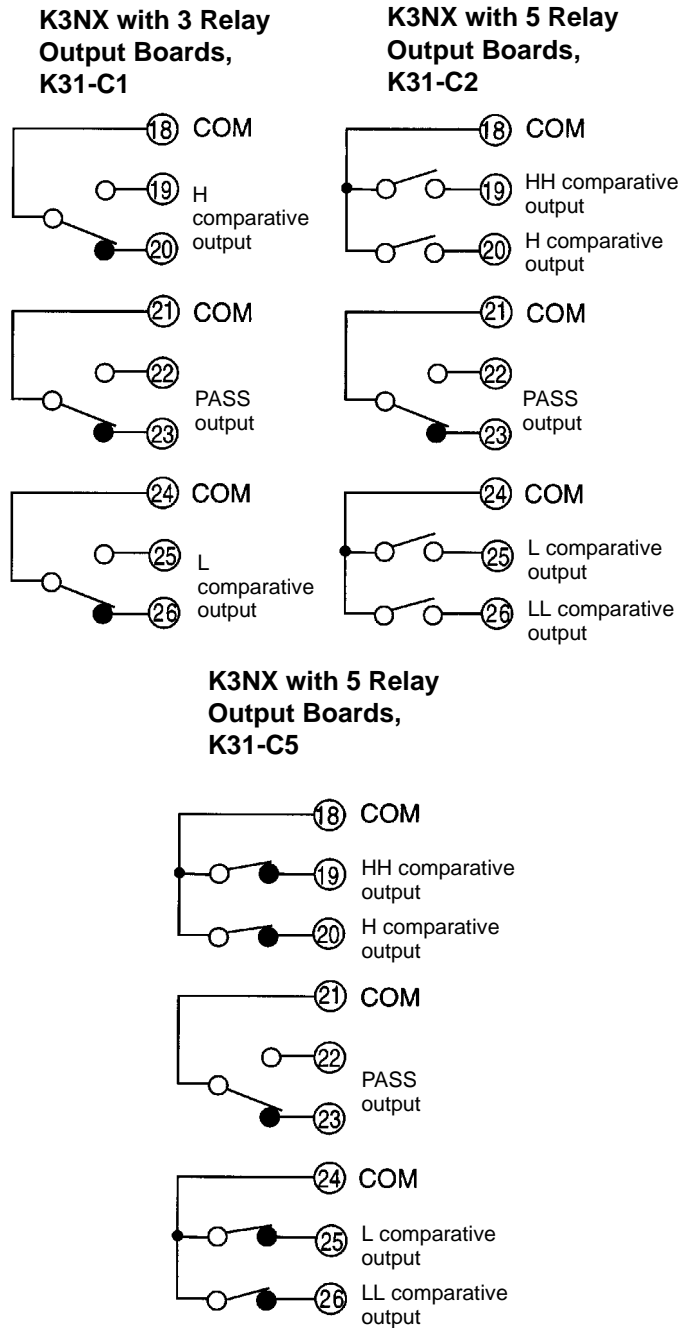

The following contact output conditions are required.

- 5 A (resistive load) at 250 VAC
- 1.5 A (inductive load) at 250 VAC
- 5 A (resistive load) at 30 VDC
- 1.5 A (inductive load) at 30 VDC

### 2-3-3 Transistor and Combination Output Board

**K3NX with Transistor Output Board, K31-T1 or K31-T2**

**K3NX with Linear Output Board, K31-L4, -L5, -L6, -L9, -L10**

**K3NX with RS-485 + 5 Relay Output Boards, K31-FLK5**

**K3NX with BCD Output Board, K31-B2 or K31-B4**

**K3NX with RS232C + 5 Transistor Output Boards, K31-FLK4**

**K3NX with RS-422 + 5 Transistor Output Boards, K31-FLK6**

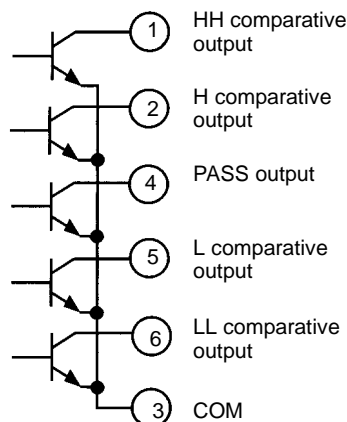
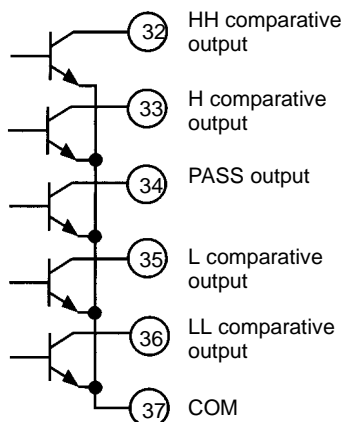
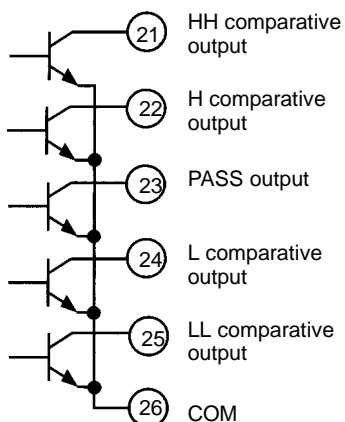

The following transistor output conditions are required.

Maximum rated voltage: 24 VDC

Load current: 50 mA

Current leakage with transistor turned off: 100  $\mu$ A.

### 2-3-4 Linear Output Board

The following figures show connections for linear output.

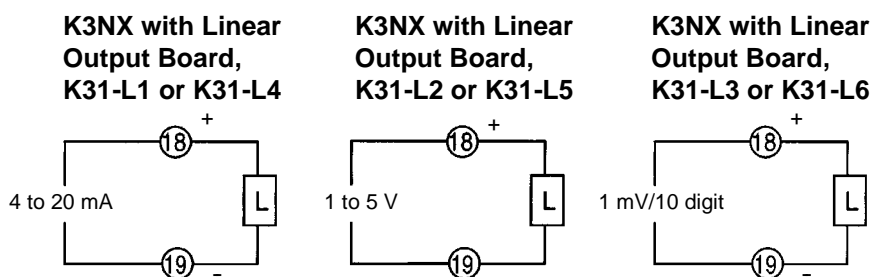

The following linear output conditions are required.

Linear output	Permissible load resistance	Resolution	Output error
4 to 20 mA	600 $\Omega$ max.	4096	$\pm 0.5\%$ FS
1 to 5 V	500 $\Omega$ min.	4096	$\pm 0.5\%$ FS
1 mV/10 digit	1 k $\Omega$ min.	4096	$\pm 1.5\%$ FS

### 2-3-5 BCD Output Board

Refer to *Section 6 BCD Output* for the terminal arrangement and interface.

# SECTION 3

## Parameter Setting

This section provides instructions for setting the parameters of the K3NX. Be sure to read this section before using the K3NX Process Meter for the first time.

3-1	Overview .....	20
3-1-1	Heading Symbols .....	20
3-1-2	Setting Procedures .....	20
3-2	Setting Mode .....	21
3-2-1	Selecting Setting Mode .....	21
3-2-2	Menu Overview .....	22
3-2-3	Setting Value Menu (5u5Et) .....	23
	HH Set Value (5u.HH) .....	23
	H Set Value (5u. H) .....	23
	L Set Value (5u. L) .....	23
	LL Set Value (5u.LL) .....	23
3-2-4	Scaling Menu (5LRLE) .....	27
	Input Value 2 (LnP.2) .....	27
	Display Value 2 (dSP.2) .....	27
	Input Value 1 (LnP.1) .....	27
	Display Value 1 (dSP.1) .....	27
	Decimal Point Position (dEL-P) .....	27
3-2-5	Setup Menu (5ELUP) .....	32
	Input Range (Ln-t) .....	32
	Power Supply Frequency (FrE) .....	34
	Communications Unit Number (U-nō) .....	36
	Baud Rate (bPS) .....	36
	Word Length (LEn) .....	38
	Stop Bits (5b-t) .....	38
	Parity Bits (Pr-tY) .....	38
3-2-6	Option Menu (ōPL) .....	41
	Average Processing (Auō) .....	41
	Startup Compensation Time (5tLnE) .....	44
	Hysteresis (HY5) .....	46
	Comparative Output Pattern (L-ōUt) .....	48
	Upper Limit (H) of Linear Output Range (L5Et.H) .....	51
	Lower Limit (L) of Linear Output Range (L5Et.L) .....	51
	Remote/Local Programming (r-L) .....	54
3-3	Protect Mode .....	56
3-3-1	Selecting Protect Mode .....	56
3-3-2	Menu Overview .....	57
3-3-3	Protect Menu (Pr-ōt) .....	58
	All Key Protect (ALL) .....	58
	Setting Value Change Prohibit (5u5Et) .....	59
	Forced-zero Prohibit (E-rō) .....	61
	Maximum/Minimum Value Clear Prohibit (ōn.r5t) .....	63
	Security (5ELr) .....	65

## 3-1 Overview

### 3-1-1 Heading Symbols

The following symbols are used for headings in this section.



FUNCTION

This symbol precedes an explanation of the parameter's meaning and function.



SETTING

This symbol precedes a description of the settings, setting range, and default value.



PROCEDURE

This symbol precedes an explanation of procedures for parameters that specify operations.



REFERENCE

This symbol precedes a listing of references and related parameters.



MODELS

This symbol precedes a listing of the models in which this parameter can be used.

### 3-1-2 Setting Procedures

- The K3NX has four modes: RUN mode for normal operations, Setting mode for initial parameter input, Protect mode for lock-out configuration, and Maintenance mode for initializing set values and user calibration. The parameters that are accessible on any individual K3NX will vary depending on the Output Board installed. Refer to *Appendix D Available Parameters*.

- The K3NX is in RUN mode when the K3NX is turned on. Parameter settings in protect or setting mode are described below on the basis that the parameters are set for the first time.

For the operation in RUN mode, refer to *Section 4 Operations in RUN Mode*.

- The setting examples are provided on condition that the factory-set values of the K3NX have not been changed.

## 3-2 Setting Mode

### 3-2-1 Selecting Setting Mode

- The K3NX in RUN mode will go into setting mode if the Mode Key is pressed for 1 s minimum.
- The K3NX in setting mode will go into RUN mode if the Escape Key is pressed.

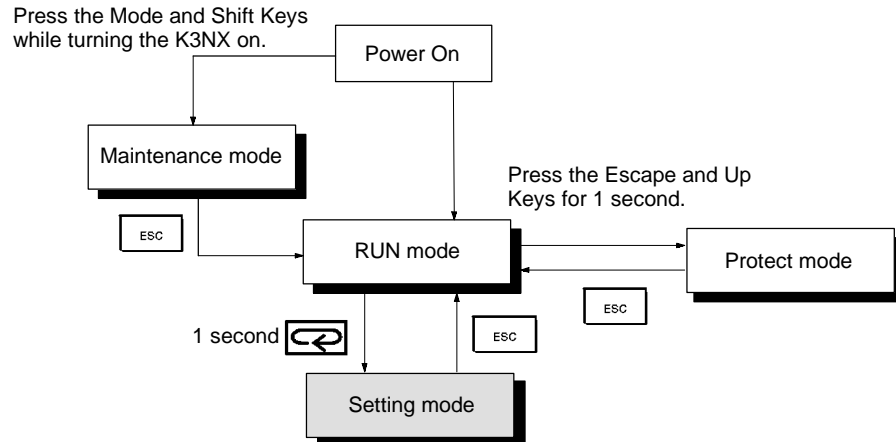

- The menu in each mode changes whenever the Mode Key is pressed.
- If the Mode Key is pressed for more than one second while a menu is displayed, a parameter will be displayed.
- The parameter changes whenever the Mode Key is pressed.
- If the Shift Key is pressed while a parameter is displayed, the parameter will be ready to change.
- Press the Up Key to change parameters.
- The digit of a set value is selected with the Shift Key and changed with the Up Key.
- The PROG indicator is lit while a menu or parameter is displayed.
- The PROG indicator flashes during a set value change.

**Note** If the input range is changed, all the other parameters will be set to default values. Therefore, set the input range first.

### 3-2-2 Menu Overview

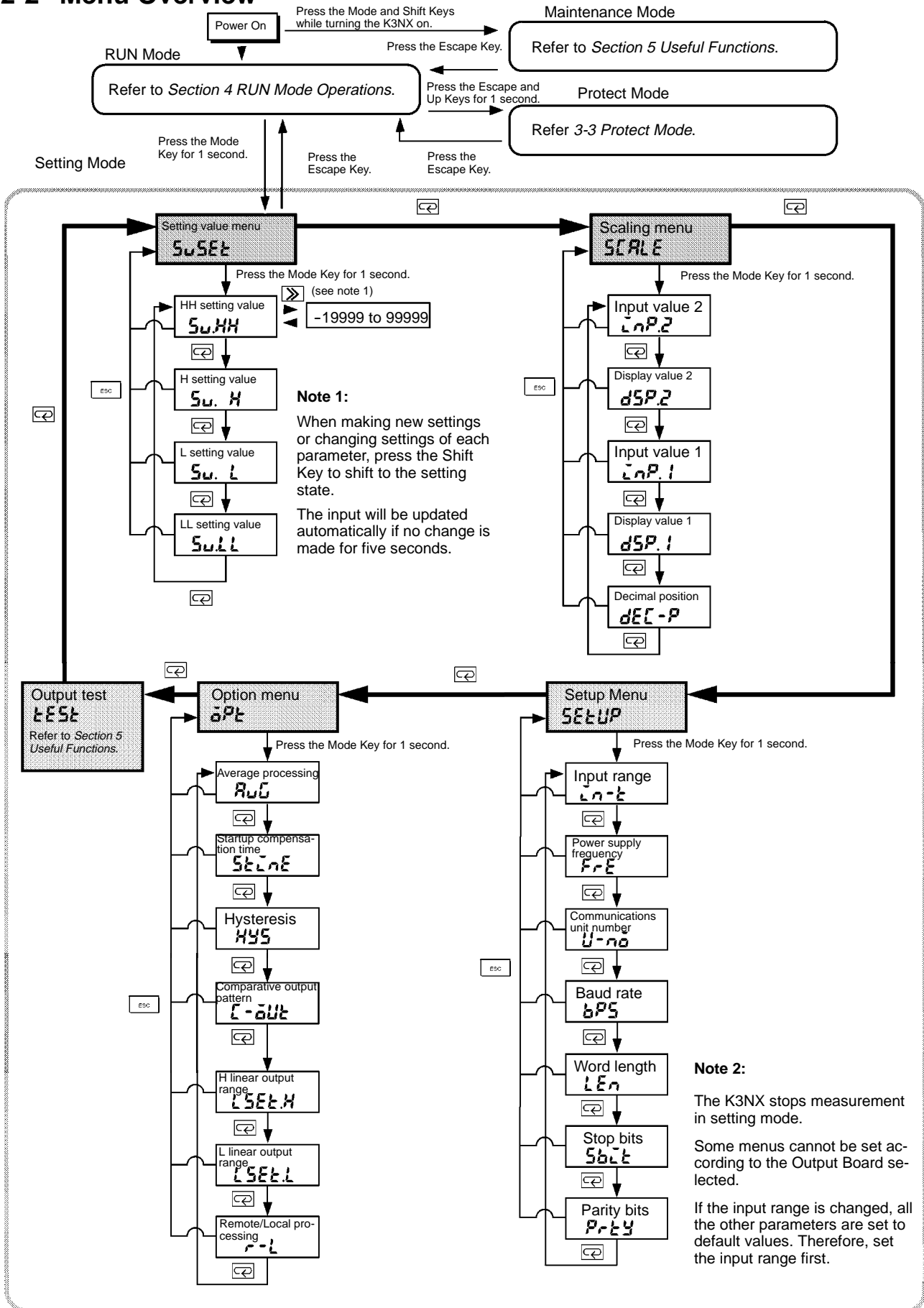

### 3-2-3 Setting Value Menu (SuSEt)

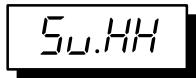
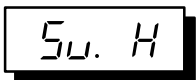
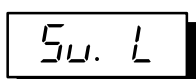
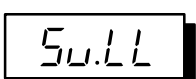
-  **HH Set Value**
-  **H Set Value**
-  **L Set Value**
-  **LL Set Value**



FUNCTION



SETTING

- There are two basic methods for setting HH, H, L, and LL set values: by entering during RUN mode via the front panel keys, setting in Setting mode, or by the teaching function.

Input type	Setting range	Default	
		Set Value	Default
DC voltage input	-19999 to 99999	HH set value	19999
		H set value	19999
		L set value	-19999
		LL set value	-19999
DC current input	-19999 to 99999	HH set value	19999
		H set value	19999
		L set value	-19999
		LL set value	-19999
AC voltage input	-19999 to 99999	HH set value	4000
		H set value	4000
		L set value	00
		LL set value	00
AC current input	-19999 to 99999	HH set value	10000
		H set value	10000
		L set value	0000
		LL set value	0000



REFERENCE

Refer to 5-1 Teaching Function.  
Refer to 4-2 Displaying and Changing Set Values.



MODELS

- The setting value menu is only available for K3NX with the Comparative Output Board.



**SETTING EXAMPLE**

Follow the steps described below to input the following.

- Setting value HH = "8000"
- Setting value H = "6000"
- Setting value L = "4000"
- Setting value LL = "2000"

Set Value LED Display Model      Basic Model

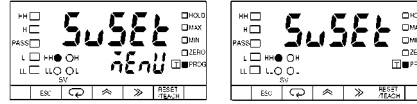

- 1, 2, 3...
1. Press the Mode Key for more than one second while the *SuSEt* setting value menu is displayed. The *Su.HH* HH setting value setting will be displayed.

Set Value LED Display Model      Basic Model

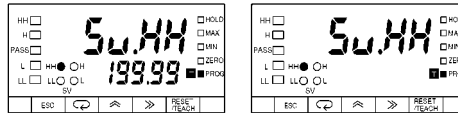

2. Press the Shift Key to display the set value *199.99* for changing. The PROG indicator will flash.

Set Value LED Display Model      Basic Model

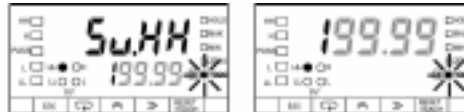

3. Press the Up and Shift Keys to set the value to *8000*. The input will be validated automatically if no change is made for five seconds. The *Su.HH* HH setting value setting will be displayed again.

**Note** Press the Mode Key to enter the set value immediately. The *Su.H* H setting value setting will be displayed for setting the next parameter.

Set Value LED Display Model      Basic Model



4. Press the Mode Key to display the *Su.H* H setting value setting.

Set Value LED Display Model      Basic Model

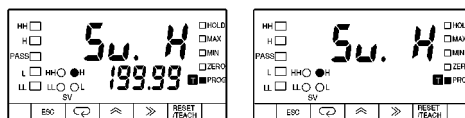

5. Press the Shift Key to display the set value *199.99* for changing. The PROG indicator will flash.

Set Value LED Display Model      Basic Model

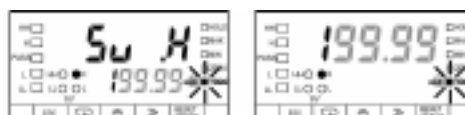

- Press the Up and Shift Keys to set the value to 6000. The input will be validated automatically if no change is made for five seconds. The  $S_u.HH$  setting value setting will be displayed again.

**Note** Press the Mode Key to enter the set value immediately. The  $S_u.LL$  setting value setting will be displayed for setting the next parameter.

Set Value LED Display Model      Basic Model

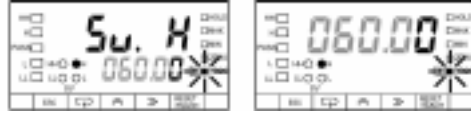

- Press the Mode Key to display the  $S_u.LL$  setting value setting.

Set Value LED Display Model      Basic Model

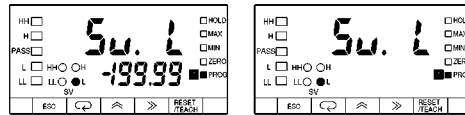

- Press the Shift Key to display the set value - 199.99 for changing. The PROG indicator will flash.

Set Value LED Display Model      Basic Model



- Press the Up and Shift Keys to set the value to 4000. The input will be validated automatically if no change is made for five seconds. The  $S_u.LL$  setting value setting will be displayed again.

**Note** Press the Mode Key to enter the set value immediately. The  $S_u.LL$  setting value setting will be displayed for setting the next parameter.

Set Value LED Display Model      Basic Model

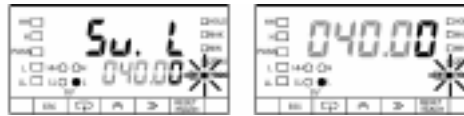

- Press the Mode Key to display the  $S_u.LL$  LL setting value setting.

Set Value LED Display Model      Basic Model

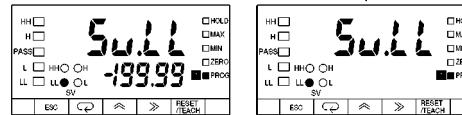

- Press the Shift Key to display the set value - 199.99 for changing. The PROG indicator will flash.

Set Value LED Display Model      Basic Model

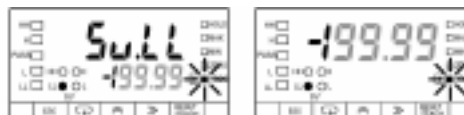

- Press the Up and Shift Keys to set the value to 2000. The input will be validated automatically if no change is made for five seconds. The  $S_{u,LL}$  LL setting value setting will be displayed again.

**Note** Press the Mode Key to enter the set value immediately. The  $S_{u,HH}$  HH setting value setting will be displayed for setting the next parameter.

Set Value LED Display Model      Basic Model

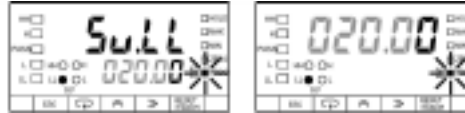



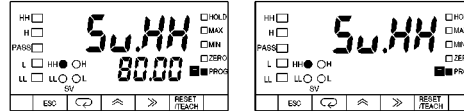

- Press the Mode Key to display the  $S_{u,HH}$  HH set value setting.

Set Value LED Display Model      Basic Model

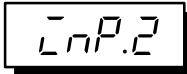

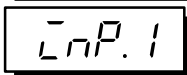
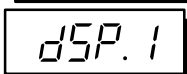
### 3-2-4 Scaling Menu (SCALE)

	<u>Input Value 2</u>
	<u>Display Value 2</u>
	<u>Input Value 1</u>
	<u>Display Value 1</u>
	<u>Decimal Point Position</u>



FUNCTION

There are two basic methods for scaling the Process Meter to display engineering units: scaling by using measured input values or scaling without connecting a sensor.

- By setting display value 1 to correspond to input value 1 and display value 2 to correspond to input value 2, scaling is possible for display on the line that connects these display values together.
- The teaching function can be used for setting input values 1 and 2.
- Input value 1 can be greater or less than input value 2 and display value 1 can be greater or less than display value 2.
- Input value 1 cannot be the same as input value 2, otherwise input value 2 will be automatically set to a value obtained by adding 1 to input value 1.
- Set the scaling value after setting the input range.

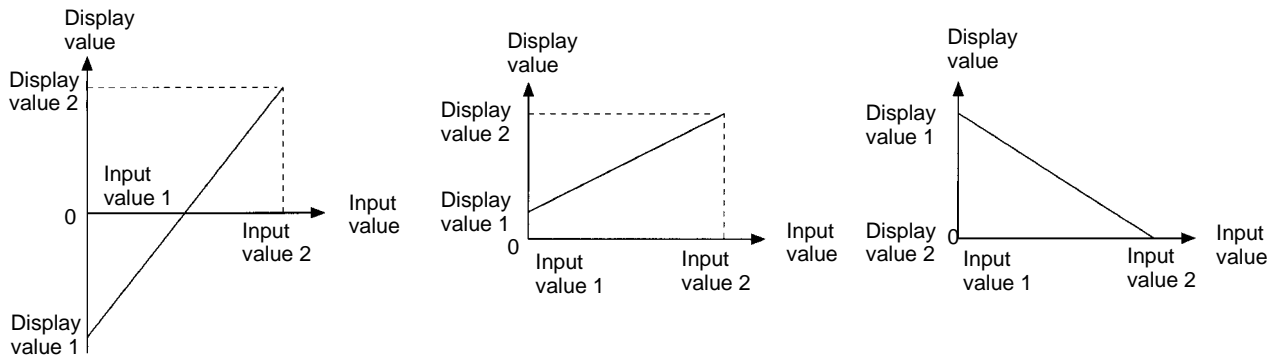

For example, if a sensor with 4- to 20-mA output is connected to the K3NX and the K3NX is set so that it will display "0" for 4-mA input and "999" for 20-mA input, the following will be the relationship between input and display values.

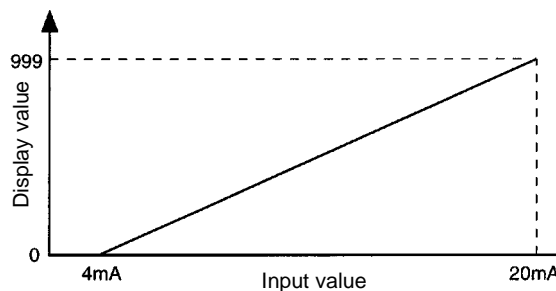



SETTING

• Input and Display Values

Input type	Setting range	Default	
DC voltage input	-19999 to 99999	Input value 2	199.99
		Display value 2	199.99
		Input value 1	-199.99
		Display value 1	-199.99
DC current input	-19999 to 99999	Input value 2	199.99
		Display value 2	199.99
		Input value 1	-199.99
		Display value 1	-199.99
AC voltage input	-19999 to 99999	Input value 2	400.0
		Display value 2	400.0
		Input value 1	0.0
		Display value 1	0.0
AC current input	-19999 to 99999	Input value 2	10.000
		Display value 2	10.000
		Input value 1	0.000
		Display value 1	0.000

• Decimal Point Position

Input type	Setting range	Default
DC voltage input	00000 (without decimal point)	000.00
DC current input	0.0000	000.00
AC voltage input	00.000	0000.0
AC current input	0000.0	00.000



REFERENCE

Refer to 5-1 Teaching Function for scaling the Process Meter with the sensor connected.

**SETTING EXAMPLE**

Follow the steps described below to input the following.

- Input value 2 = "5.00"
- Display value 2 = "1000.0"
- Input value 1 = "1.00"
- Display value 1 = "0.0"
- Decimal point position = "- - - - . -"

Set Value LED Display Model      Basic Model

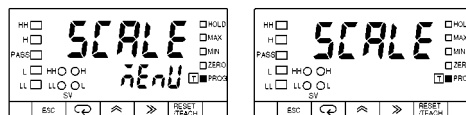

- 1, 2, 3... 1. Press the Mode Key for more than one second while the *SCALE* scaling menu is displayed. The *LnP.2* input value 2 setting will appear.

Set Value LED Display Model      Basic Model

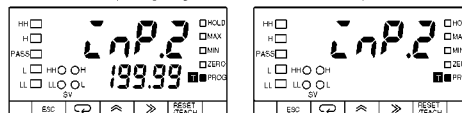

- Press the Shift Key to display the prior set value *199.99* for changing. The PROG indicator will flash.

Set Value LED Display Model      Basic Model



- Press the Up and Shift Keys to set the value to *005.00*. The input will be validated automatically if no change is made for five seconds. The *LnP.2* input value 2 setting will be displayed again.

**Note** Press the Mode Key to enter the set value immediately. The *dSP.2* display value 2 setting will be displayed for setting the next parameter.

Set Value LED Display Model      Basic Model



- Press the Mode Key to display the *dSP.2* display value 2 setting.

Set Value LED Display Model      Basic Model

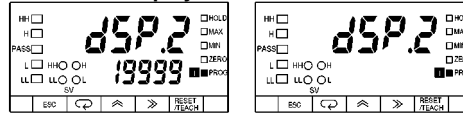

- Press the Shift Key to display the set value *19999* for changing. The PROG indicator will flash.

Set Value LED Display Model      Basic Model



- Press the Up and Shift Keys to set the value to *10000*. The input will be validated automatically if no change is made for five seconds. The *dSP.2* display value 2 setting will be displayed again.

**Note** Press the Mode Key to enter the set value immediately. The *LnP.1* input value 1 setting will be displayed for setting the next parameter.

Set Value LED Display Model      Basic Model



- Press the Mode Key to display the *LnP.1* input value 1 setting.

Set Value LED Display Model      Basic Model

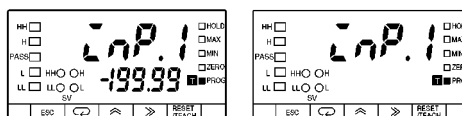

- Press the Shift Key to display the prior set value - 199.99 for changing. The PROG indicator will flash.

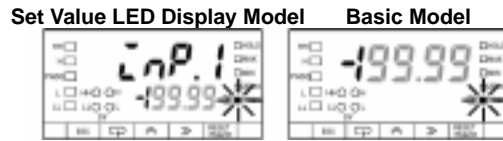

- Press the Up and Shift Keys to set the value to 00 1.00. The input will be validated automatically if no change is made for five seconds. The dSP. 1 input value 1 setting will be displayed again.

**Note** Press the Mode Key to enter the set value immediately. The dSP. 1 display value 1 setting will be displayed for setting the next parameter.

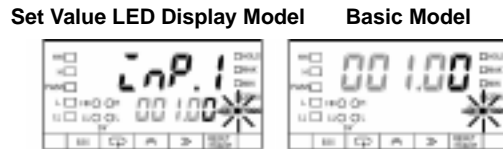

- Press the Mode Key to display the dSP. 1 display value 1 setting.

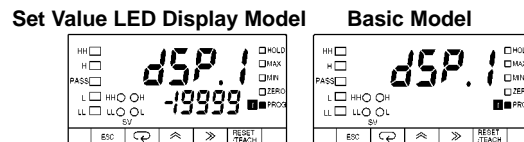

- Press the Shift Key to display the prior set value - 19999 for changing. The PROG indicator will flash.

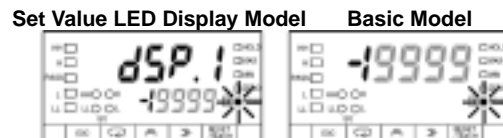

- Press the Up and Shift Keys to set the value to 00000. The input value will be validated automatically if no change is made for five seconds. The dSP. 1 display value 1 setting will be displayed again.

**Note** Press the Mode Key to enter the set value immediately. The dEC-P decimal point position setting will be displayed for setting the next parameter.

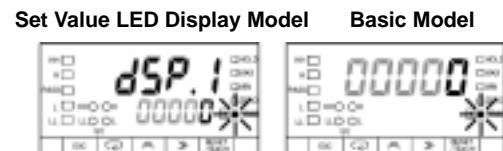

- Press the Mode Key to display the dEC-P decimal point position setting.

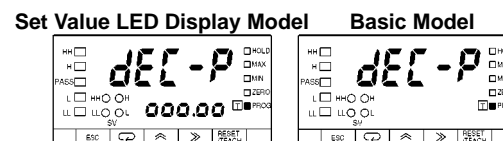

- Press the Shift Key to display the prior decimal point position  $000.00$  for changing. The PROG indicator will flash.

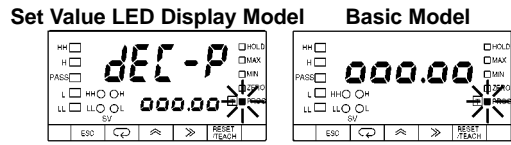

- Press the Up Key to set the decimal point position to  $0000.0$ . The input will be validated automatically if no change is made for five seconds. The  $\bar{L}nP.2$  input value 2 setting will be displayed again.

**Note** Press the Mode Key to enter the decimal point position immediately. The  $\bar{L}nP.2$  input value 2 setting will be displayed again.

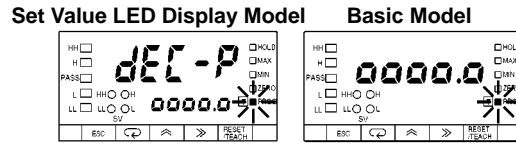

- Press the Mode Key to display the  $\bar{L}nP.2$  input value 2 setting.

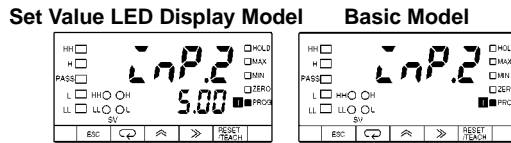



### 3-2-5 Setup Menu (SETUP)

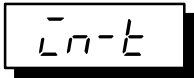

#### Input Range



FUNCTION



SETTING

- Select the appropriate input type signal. All parameters will be set to default values if the input range is changed.

Input type	Setting range	Measurement range	Default
DC voltage input	R ud	-199.99 to 199.99 V	R ud
	b ud	-19.000 to 19.999 V	
	c ud	-1.9999 to 1.9999 V	
	d ud	-199.99 to 199.99 mV	
	E ud	1.0000 to 5.0000 V	
DC current input	R Rd	-199.99 to 199.99 mA	R Rd
	b Rd	-19.999 to 19.999 mA	
	c Rd	-1.9999 to 1.9999 mA	
	d Rd	4.000 to 20.000 mA	
AC voltage input	R uR	0.0 to 400.0 V	R uR
	b uR	0.00 to 199.99 V	
	c uR	0.000 to 19.999 V	
	d uR	0.0000 to 1.9999 V	
AC current input	R RR	0.000 to 10.000 A	R RR
	b RR	0.0000 to 1.9999 A	
	c RR	0.00 to 199.99 mA	
	d RR	0.000 to 19.999 mA	



REFERENCE

Refer to 2-2 Base Unit.

#### SETTING EXAMPLE

Follow the steps described below to change E ud from R ud.

Set Value LED Display Model

Basic Model

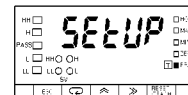
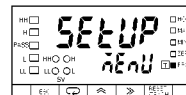

- 1, 2, 3...
1. Press the Mode Key for more than one second while the *SETUP* setup menu is displayed. The *Ln-t* input range setting will appear.

Set Value LED Display Model

Basic Model

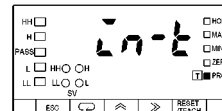
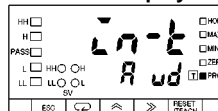

- Press the Shift Key to display the prior set value  $R_{ud}$  for changing. The PROG indicator will flash.

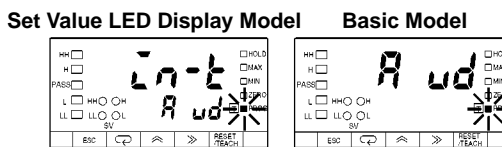

- Repeatedly press the Up Key until  $E_{ud}$  is displayed. The displayed setting will be validated automatically if no change is made for five seconds. The  $Ln-t$  input range setting will be displayed again.

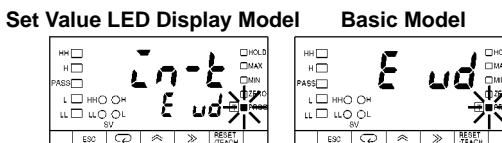

When no operation is executed for five seconds

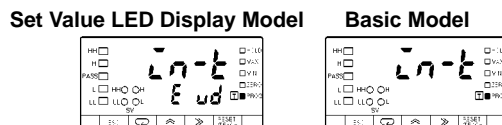

**Note** Press the Mode Key to enter the displayed setting immediately. The next parameter will be displayed for setting.



**F-r-E**

**Power Supply Frequency**

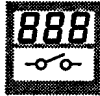

FUNCTION



SETTING

- Set the number of sampling times in the setup menu according to the power supply frequency in order to shut off inductive noise that may be generated from the power supply.

Setting	Unit	Number of sampling times	Default
50/60	Hz	50: 12.5 times/second 60: 15 times/second	50

**SETTING EXAMPLE**

Follow the steps described below to set the power supply frequency to 60 Hz.

Set Value LED Display Model      Basic Model

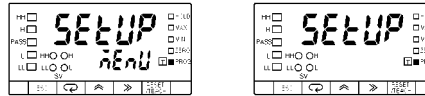

- 1, 2, 3...
1. Press the Mode Key for more than one second while the *SETUP* setup menu is displayed. The *Ln-t* input range setting will appear.

Set Value LED Display Model      Basic Model



2. Press the Mode Key to display the *F-r-E* power supply frequency setting.

Set Value LED Display Model      Basic Model

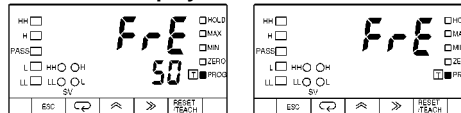

3. Press the Shift Key to display the prior set value *50* for changing. The *PROG* indicator will flash.

Set Value LED Display Model      Basic Model

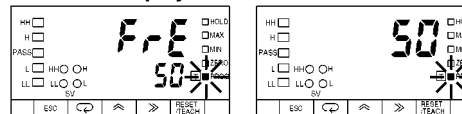

4. Press the Up Key to display the set value *60*. The displayed value will be validated automatically if no change is made for five seconds. The *F-r-E* power supply frequency setting will be displayed again.

Set Value LED Display Model      Basic Model

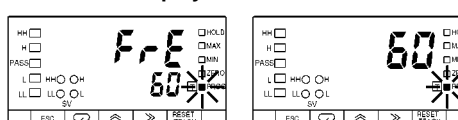

When no operation is executed for five seconds

Set Value LED Display Model      Basic Model



**Note** Press the Mode Key to enter the displayed setting immediately. The next parameter will be displayed for setting.

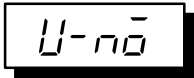

**Communications Unit Number**

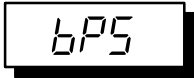

**Baud Rate**

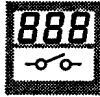

FUNCTION

- Set a communications unit number as an identification number by which the host computer is connected to the K3NX.
- If more than one K3NX is connected in parallel, make sure that each communications unit number is unique.
- The baud rate should be set to the baud rate of the host computer.



SETTING

- Communications Unit Number

Setting range	Unit	Default
00 to 99	---	00

- Baud Rate

Setting range	Default
1200: 1,200 bps / 2400: 2,400 bps / 4800: 4,800 bps / 9600: 9,600 bps / 19200: 19.2 Kbps / 38400: 38.4 Kbps	9600



MODELS

This setting is available for the K3NX with the Communications Output Board.

**SETTING EXAMPLE**

Follow the steps described below to set the communications unit number to 15 and the baud rate to 19,200 bps.

Set Value LED Display Model

Basic Model

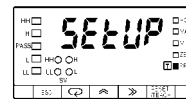
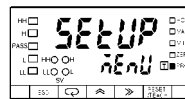

- 1, 2, 3...
1. Press the Mode Key for more than one second while the *SETUP* setup menu is displayed. The *U-nō* input range setting will appear.

Set Value LED Display Model

Basic Model

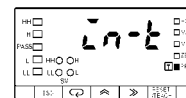
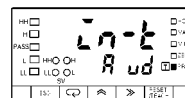

2. Repeatedly press the Mode Key until the *U-nō* communications unit number setting is displayed.

Set Value LED Display Model

Basic Model

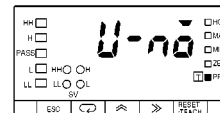
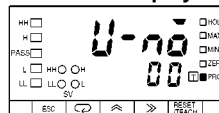

- Press the Shift Key to display the prior set value *00* for changing. The PROG indicator will flash.

Set Value LED Display Model      Basic Model

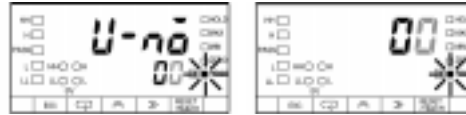

- Press the Up and Shift Keys to set the value to *15*. The input value will be validated automatically if no change is made for five seconds. The *U-nō* communications unit number setting will be displayed again.

**Note** Press the Mode Key to enter the set value immediately. The next parameter will be displayed for setting.

Set Value LED Display Model      Basic Model



- Press the Mode Key to display the *bPS* baud rate setting.

Set Value LED Display Model      Basic Model

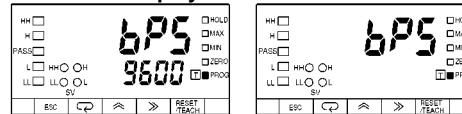

- Press the Shift Key to display the prior set value *9600* for changing. The PROG indicator will flash.

Set Value LED Display Model      Basic Model

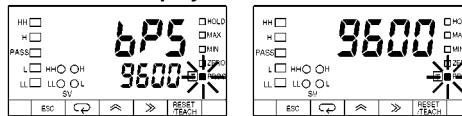

- Press the Up Key to set the value to *19200*. The input will be validated automatically if no change is made for five seconds. The *bPS* baud rate setting will be displayed again.

**Note** Press the Mode Key to enter the set value immediately. The next parameter will be displayed again for setting.

Set Value LED Display Model      Basic Model

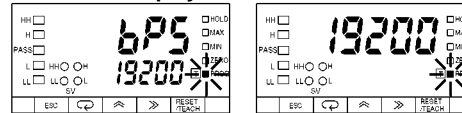

- Press the Up Key to enter the set value for setting the next parameter. The input value will be validated automatically if no change is made for five seconds. The *bPS* baud rate setting will be displayed again.

Set Value LED Display Model      Basic Model

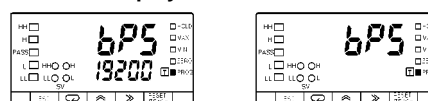

LEN

Word Length

Sbct

Stop Bits

Prty

Parity Bits



FUNCTION



SETTING

- The communications format used for communicating with the host computer is set in the setup menu.
- Refer to the *Communications Manual* for the communications format in detail.

- Word Length

Setting	Unit	Default
7/8	bit	7

- Stop Bits

Setting	Unit	Default
1/2	bit	2

- Parity Bit

Setting	Default
nōnĒ: None ĒuĒn: Even ōōd: Odd	ĒuĒn



MODELS

This setting is available for the K3NX with the Communications Output Board.

**SETTING EXAMPLE**

Follow the steps described below to set the following.

- Word length: 8 bits
- Number of stop bits: 1
- Parity bits: nōnĒ

Set Value LED Display Model

Basic Model

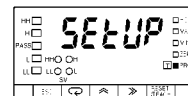
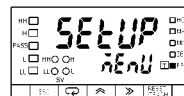

1, 2, 3...

1. Press the Mode Key for more than one second while the *SETUP* setup menu is displayed. The *LEN* input range setting will appear.

Set Value LED Display Model

Basic Model

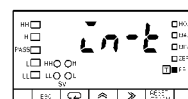
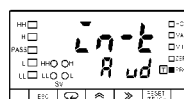

- Repeatedly press the Mode Key until the *LEn* word length setting is displayed.

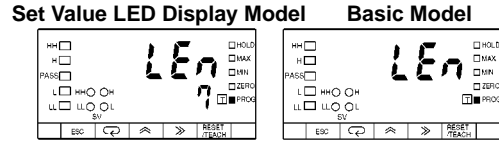

- Press the Shift Key to display the prior set value 7 for changing. The PROG indicator will flash.

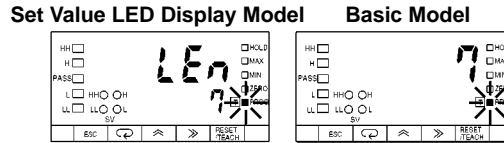

- Press the Up Key to set the value to 8. The input value will be validated automatically if no change is made for five seconds. The *LEn* word length setting will be displayed again.

**Note** Press the Mode Key to enter the set value immediately. The next parameter will be displayed for setting.

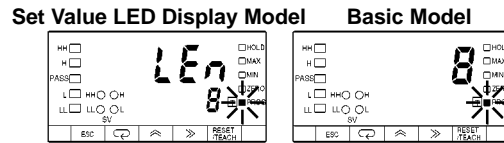

- Press the Mode Key to display the *Sbct* stop bit setting.

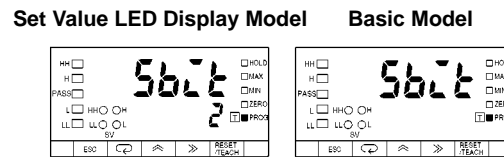

- Press the Shift Key to display the set value 2 for changing.

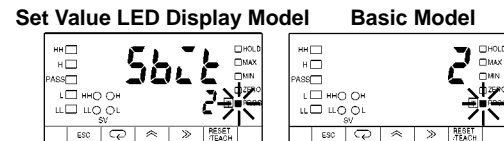

- Press the Up Key to set the value to 1. The input will be validated automatically if no change is made for five seconds. The *Sbct* stop bit setting will be displayed again.

**Note** Press the Mode Key to enter the set value immediately. The next parameter will be displayed for setting.

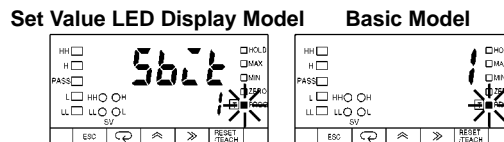

- Press the Mode Key to display the *PrtY* parity bit setting.

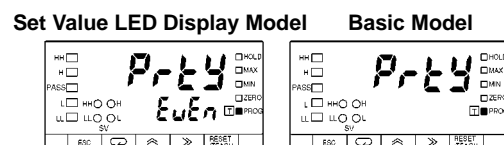



9. Press the Shift Key to display  $E_{uE}n$  for changing.

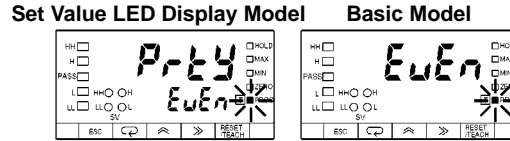

10. Press the Up Key to display  $n\bar{o}nE$ . The setting will be validated automatically if no change is made for five seconds. The  $P_{rty}$  parity bit setting will be displayed again.

**Note** Press the Mode Key to enter the setting immediately. The next parameter will be displayed for setting.

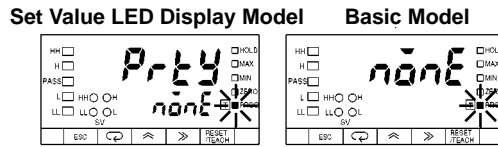

When no operation is executed for five seconds

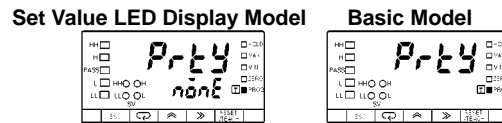

### 3-2-6 Option Menu (OPT)



#### Average Processing



FUNCTION

- The average processing of inputs are enabled for setting.
- Average processing prevents the display from fluctuating due to unstable input.
- Select simple average processing or movement average processing and the number of sampling times.



SETTING

Setting	Default
1: No average processing	1
~0002: Movement average processing by sampling 2 times	
~0004: Movement average processing by sampling 4 times	
~0008: Movement average processing by sampling 8 times	
~0016: Movement average processing by sampling 16 times	
~0032: Movement average processing by sampling 32 times	
50002: Simple average processing by sampling 2 times	
50004: Simple average processing by sampling 4 times	
50008: Simple average processing by sampling 8 times	
50016: Simple average processing by sampling 16 times	
50032: Simple average processing by sampling 32 times	



## REFERENCE

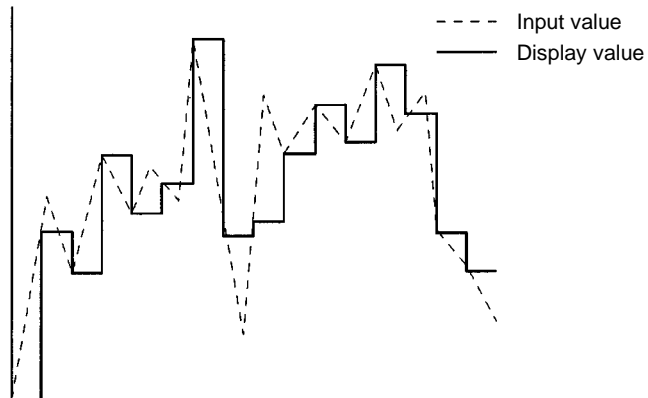

Without average processing

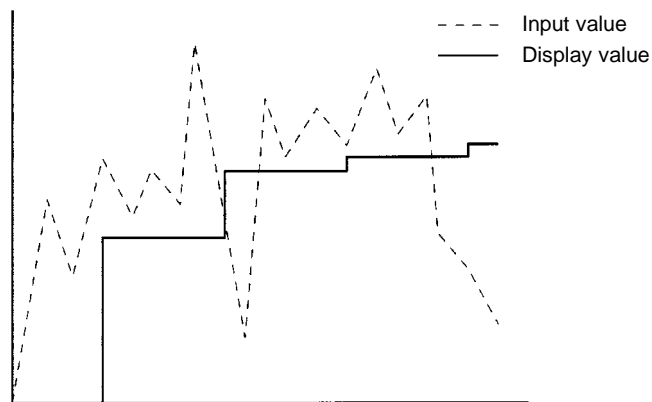

Simple average processing

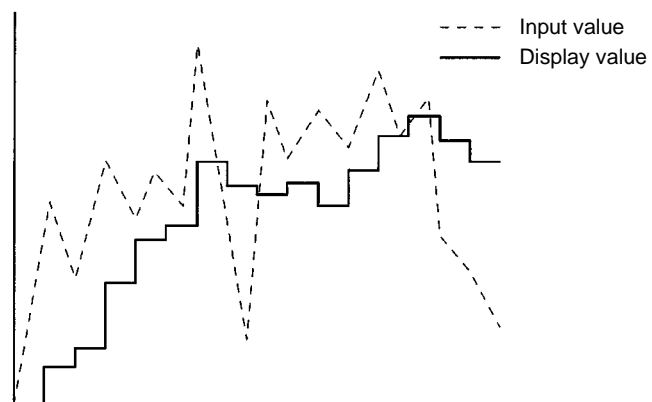

Movement average processing

**Simple Average Processing:**

The average value is displayed after the input is sampled “n” times.

The previous value is displayed until the sampling is complete.

Simple average processing is ideal for a display refresh period that is comparatively long.

The number of sampling times can be set to 2, 8, 16, or 32.

**Movement Average Processing**

When an input is sampled, the new sampling data is added to the previous sampling data and averaged.

Movement average processing is ideal for removing cyclic noise from the input signal.

The number of sampling times can be set to 2, 8, 16, or 32.

**SETTING EXAMPLE**

Follow the steps described below to set the number of movement average processing times to 16.

Set Value LED Display Model      Basic Model

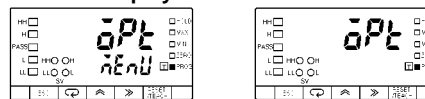

- 1, 2, 3... 1. Press the Mode Key for more than one second while the *dPt* option menu is displayed. The *AVG* average processing setting will appear.

Set Value LED Display Model      Basic Model

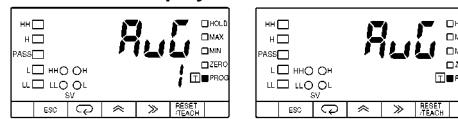

2. Press the Shift Key to display the prior setting *1* for changing. The PROG indicator will flash.

Set Value LED Display Model      Basic Model

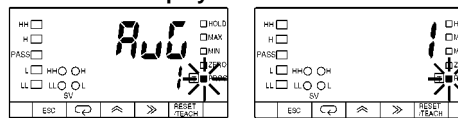

3. Repeatedly press the Up Key until *ADD 16* is displayed. The setting will be validated automatically if no change is made for five seconds. The *AVG* average processing setting will be displayed again.

**Note** Press the Mode Key to enter the set value immediately. The next parameter will be displayed for setting.

Set Value LED Display Model      Basic Model

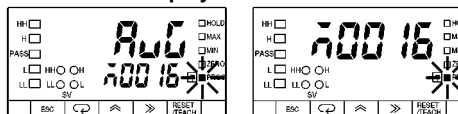

When no operation is executed for five seconds

Set Value LED Display Model      Basic Model

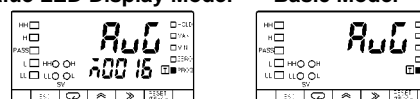

**StLnE**

**Startup Compensation Time**



FUNCTION



SETTING



REFERENCE

- The interval between the moment the K3NX is turned and the moment the K3NX enters measurement operation is set in the option menu.

Setting range	Unit	Default
0.0 to 99.9	s	0.0

The K3NX will display "00000" with all outputs turned OFF until the K3NX is in measurement operation.

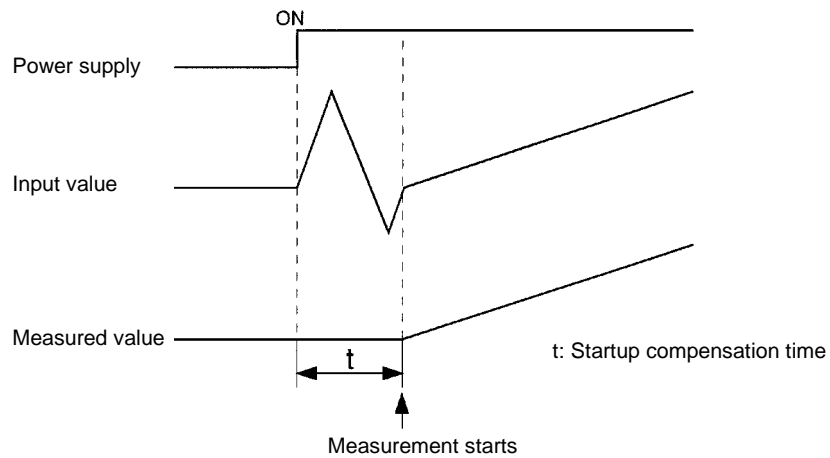

**SETTING EXAMPLE**

Follow the steps described below to set the startup compensation time to 2 seconds.

Set Value LED Display Model      Basic Model



- 1, 2, 3...
1. Press the Mode Key for more than one second while the *dPt* option menu is displayed. The *AvG* average processing setting will appear.

Set Value LED Display Model      Basic Model

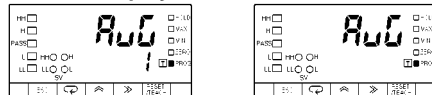

2. Press the Mode Key to display the *StLnE* startup compensation time setting.

Set Value LED Display Model      Basic Model

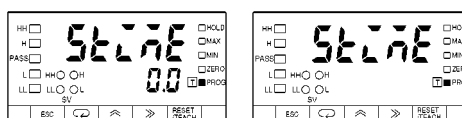

- Press the Shift Key to display the prior set value 000 for changing. The PROG indicator will flash.

Set Value LED Display Model      Basic Model



- Press the Up and Shift Keys to set the value to 020. The setting will be validated automatically if no change is made for five seconds. The StLnE start-up compensation time setting will be displayed again.

**Note** Press the Mode Key to enter the set value immediately. The next parameter will be displayed for setting.

Set Value LED Display Model      Basic Model



When no operation is executed for five seconds

Set Value LED Display Model      Basic Model



445

**Hysteresis**



FUNCTION



SETTING



REFERENCE

- The hysteresis can be set in the option menu to prevent “chattering” of the output if the measured value fluctuates in the vicinity of the setting values.
- The hysteresis can be set within a range of 1 and 9999 digits for four consecutive digits beginning with the leftmost digit regardless of the decimal point.
- The value set to 0 is regarded as 1.
- The decimal point position set in the scaling menu becomes valid.

Setting range	Unit	Default
1 to 9999	---	1

If the comparative output is a level output, however, the hysteresis will be enabled when the measured value starts to become smaller than the HH, H, LL, and L setting values.

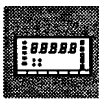
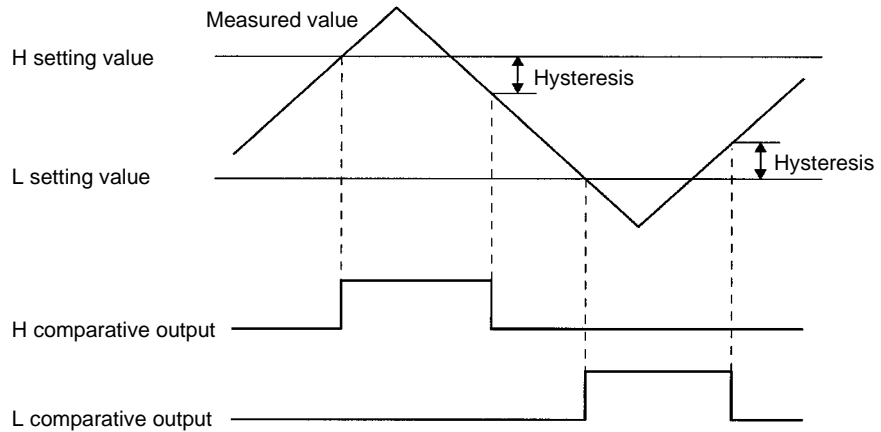

MODELS

This setting is only available for the K3NX with the Comparative Output Unit.

**SETTING EXAMPLE**

Follow the steps described below to set the hysteresis to 30.

Set Value LED Display Model      Basic Model



- 1, 2, 3... 1. Press the Mode Key for more than one second while the  $\bar{\alpha}Plt$  option menu is displayed. The  $RuG$  average processing setting will appear.

Set Value LED Display Model      Basic Model



- Repeatedly press the Mode Key until the *HYS* hysteresis setting is displayed.

Set Value LED Display Model      Basic Model

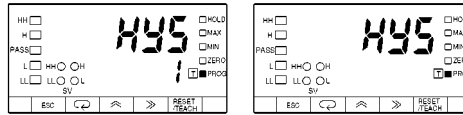

- Press the Shift Key to display the prior set value *000 1* for changing. The PROG indicator will flash.

Set Value LED Display Model      Basic Model

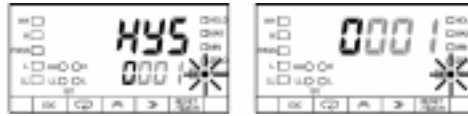

- Press the Up and Shift Keys to set the value to *0030*. The setting will be validated automatically if no change is made for five seconds. The *HYS* hysteresis setting will be displayed again.

**Note** Press the Mode Key to enter the set value immediately. The next parameter will be displayed for setting.

Set Value LED Display Model      Basic Model



When no operation is executed for five seconds

Set Value LED Display Model      Basic Model





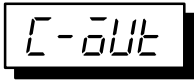

**Comparative Output Pattern**



FUNCTION



SETTING



REFERENCE

- The pattern of HH, H, L, LL, and PASS comparative outputs is set in the option menu.

Setting	Default
nōnRL: Standard output	nōnRL
EnE: Zone output	
LEuEL: Level output	

**Standard Output**

H or HH Comparative Output:

Turns ON when the measured value is larger than the H or HH setting value.

PASS Output:

Turns ON when LL, L, H, and HH comparative outputs are all OFF.

L or LL Comparative Output:

Turns ON when the measured value is smaller than the L or LL setting value.

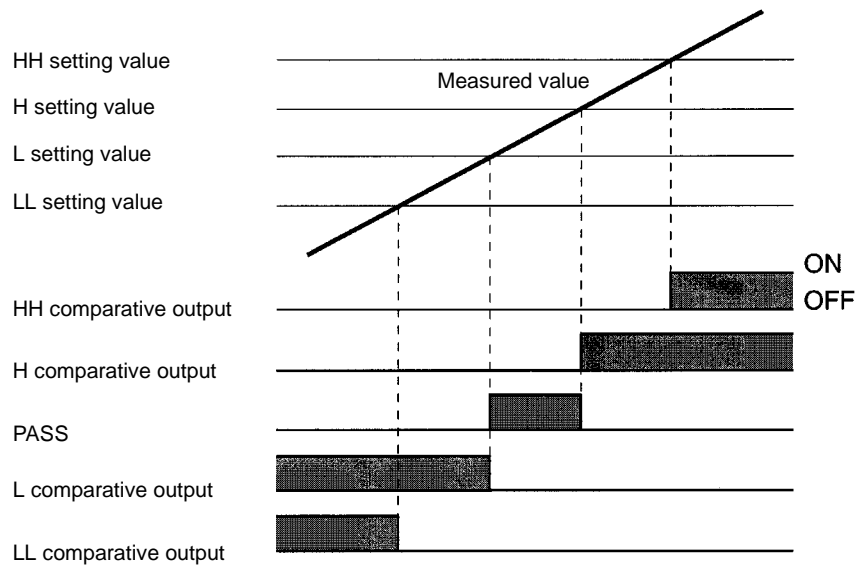

**Level Output**

LL, L, H, or HH Comparative Output:

Turns ON when the measured value exceeds the LL, L, H, or HH setting value.

PASS Output:

Turns ON when the LL, L, H, and HH comparative outputs are all OFF.

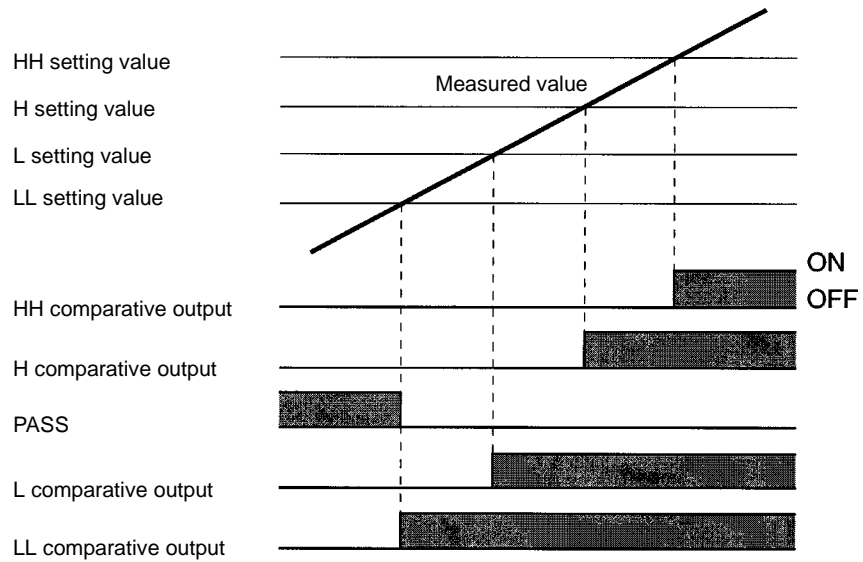

**Zone Output**

HH Comparative Output:

Turns ON when the measured value exceeds the HH setting value.

H Comparative Output:

Turns ON when the measured value is between the H and HH setting values.

PASS Output:

Turns ON when the measured value is between the L and H setting values.

L Comparative Output:

Turns ON when the measured value is between the LL and L setting values.

LL Comparative Output:

Turns ON when the measured value falls below the LL setting value.

Be sure to set the setting values so they satisfy the following formula:

$$LL < L < H < HH$$

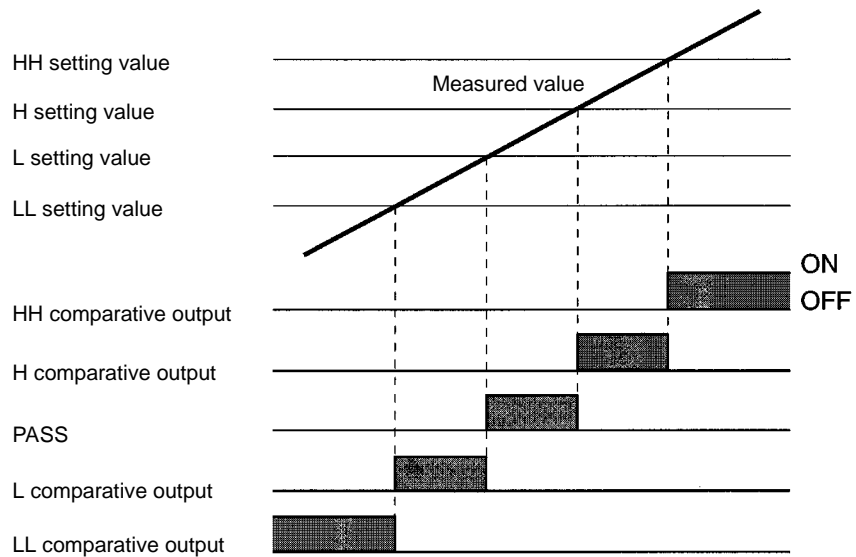

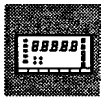

MODELS

This setting is only available for the K3NX with the Comparative Output Units.-

**SETTING EXAMPLE**

Follow the steps described below to set the comparative output pattern to level output.

Set Value LED Display Model      Basic Model

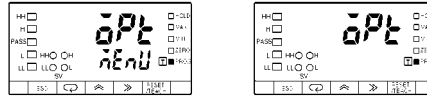

- 1, 2, 3...
1. Press the Mode Key for more than one second while the *dPt* option menu is displayed. The *Avg* average processing setting will appear.

Set Value LED Display Model      Basic Model

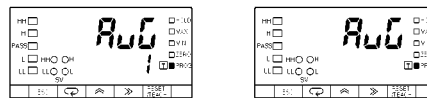

2. Repeatedly press the Mode Key until the *C-out* comparative output pattern setting is displayed.

Set Value LED Display Model      Basic Model

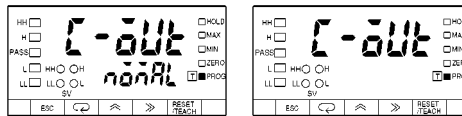

3. Press the Shift Key to display the prior setting *normal* for changing. The PROG indicator will flash.

Set Value LED Display Model      Basic Model

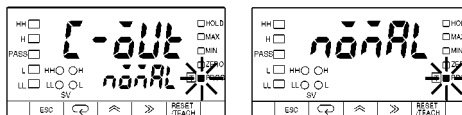

4. Press the Up Key twice to display *LEVEL*. The setting will be validated automatically if no change is made for five seconds. The *C-out* comparative output pattern setting will be displayed again.

**Note** Press the Mode Key to enter the setting immediately. The next parameter will be displayed for setting.

Set Value LED Display Model      Basic Model

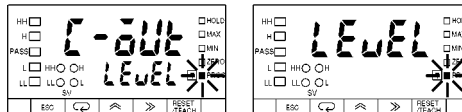

When no operation is executed for five seconds

Set Value LED Display Model      Basic Model

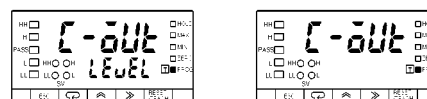

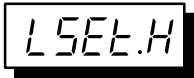

**Upper Limit (H) of Linear Output Range**



**Lower Limit (L) of Linear Output Range**

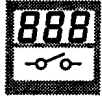

FUNCTION

Linear output setting is made in the option menu to enable the K3NX to have voltage or current output in proportion to the change in display value.

- The maximum and minimum values of linear output are set in this parameter.

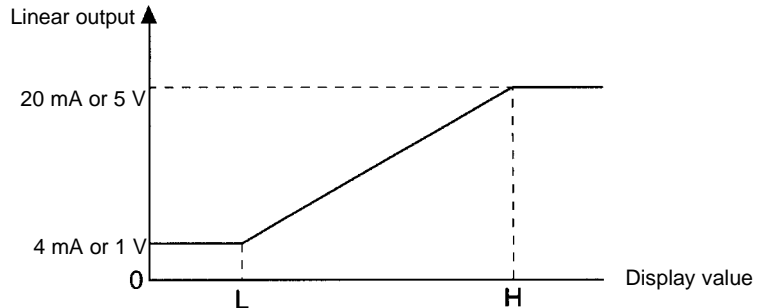

- L can be greater or less than H.
- L cannot be the same as H, otherwise H will be automatically set to a value obtained by adding 1 to L.
- The teaching function can be used for setting linear output ranges.



SETTING

Input type	Setting range	Default	
DC voltage input	-19999 to 99999	H linear output range	199.99
		L linear output range	-199.99
DC current input	-19999 to 99999	H linear output range	199.99
		L linear output range	-199.99
AC voltage input	-19999 to 99999	H linear output range	400.0
		L linear output range	0.0
AC current input	-19999 to 99999	H linear output range	10.000
		L linear output range	0.000



REFERENCE

Refer to 5-1 Teaching Function.



MODELS

This setting is available for the K3NX with the Linear Output Board.

**SETTING EXAMPLE**

Follow the steps described below to set the following.

H: 100.00

L: 0.00

Set Value LED Display Model Basic Model



- 1, 2, 3... 1. Press the Mode Key for more than one second while the *dPt* option menu is displayed. The *AUG* average processing setting will appear.

Set Value LED Display Model Basic Model

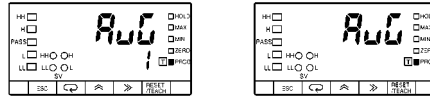

2. Repeatedly press the Mode Key until the *LSEt.H* H linear output range setting is displayed.

Set Value LED Display Model Basic Model

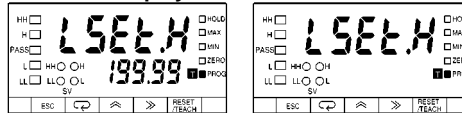

3. Press the Shift Key to display the prior set value *1999.9* for changing. The PROG indicator will flash.

Set Value LED Display Model Basic Model



4. Press the Up and Shift Keys to set the value to *100.00*. The setting will be validated automatically if no change is made for five seconds. The *LSEt.H* H linear output range setting will be displayed again.

**Note** Press the Mode Key to enter the set value immediately. The next parameter will be displayed for setting.

Set Value LED Display Model Basic Model



5. Press the Mode Key to display the *LSEt.L* L linear output range setting.

Set Value LED Display Model Basic Model

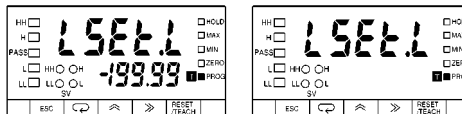

6. Press the Shift Key to display the prior set value *-1999.9* for changing. The PROG indicator will flash.

Set Value LED Display Model Basic Model

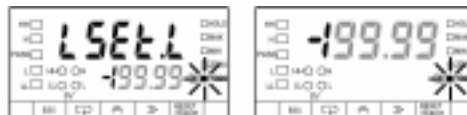

- Press the Up and Shift Keys to set the value to 000.00. The setting will be validated automatically if no change is made for five seconds. The L5Et.L L linear output range setting will be displayed again.

**Note** Press the Mode Key to enter the set value immediately. The next parameter will be displayed for setting.

Set Value LED Display Model      Basic Model

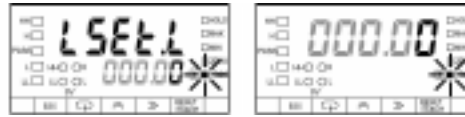

When no operation is executed for five seconds

Set Value LED Display Model      Basic Model

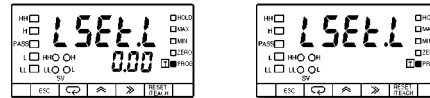

**r-L**

**Remote/Local Programming**

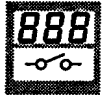

FUNCTION



SETTING



MODELS

- The K3NX can be set to remote or local mode in the option menu. The K3NX in remote mode is operated through the host computer and the K3NX in local mode is operated through the front panel key input.

Setting	Default
Remote: <i>rnl</i> Local: <i>lcl</i>	<i>lcl</i>

This setting is available for the K3NX with the Communications Output Board.

**SETTING EXAMPLE**

Follow the steps described below to set the K3NX to remote programming.

Set Value LED Display Model      Basic Model



- 1, 2, 3...
1. Press the Mode Key for more than one second while the *opt* option menu is displayed. The *Aug* setting will appear.

Set Value LED Display Model      Basic Model

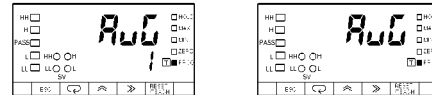

2. Repeatedly press the Mode Key until the *r-l* remote/local setting is displayed.

Set Value LED Display Model      Basic Model

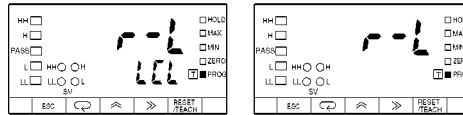

3. Press the Shift Key to display the prior setting *lcl* for changing. The PROG indicator will flash.

Set Value LED Display Model      Basic Model

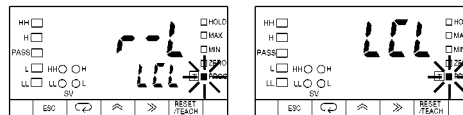

4. Press the Up Key to display *rnl*.

Set Value LED Display Model      Basic Model

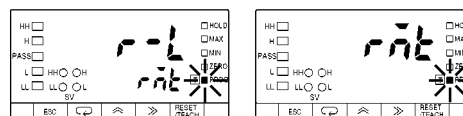

- The setting will be validated automatically if no change is made for five seconds. The *AVG* average processing setting will be displayed again.

**Note** Press the Mode Key to enter the setting immediately. The *r-l* remote/local setting will be displayed again.

**Set Value LED Display Model      Basic Model**

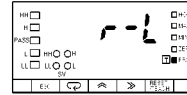
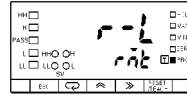



## 3-3 Protect Mode

### 3-3-1 Selecting Protect Mode

- The K3NX in RUN mode will go into protect mode if the Escape and Up Keys are pressed for more than 1 second.
- The K3NX in protect mode will go into RUN mode if the Escape Key is pressed.

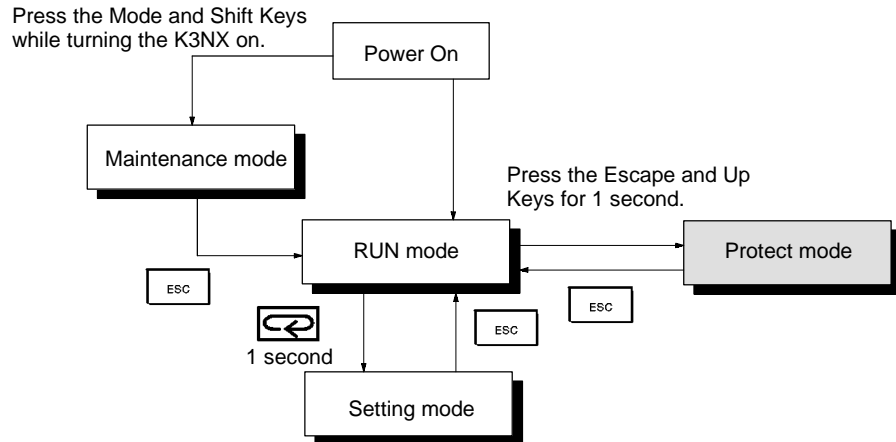

- If the Mode Key is pressed for more than one second while a menu is displayed, a parameter will be displayed.
- The parameter changes whenever the Mode Key is pressed.
- If the Shift Key is pressed while a parameter is displayed, the parameter will be ready to change.
- Press the Up Key to change parameters.

### 3-3-2 Menu Overview

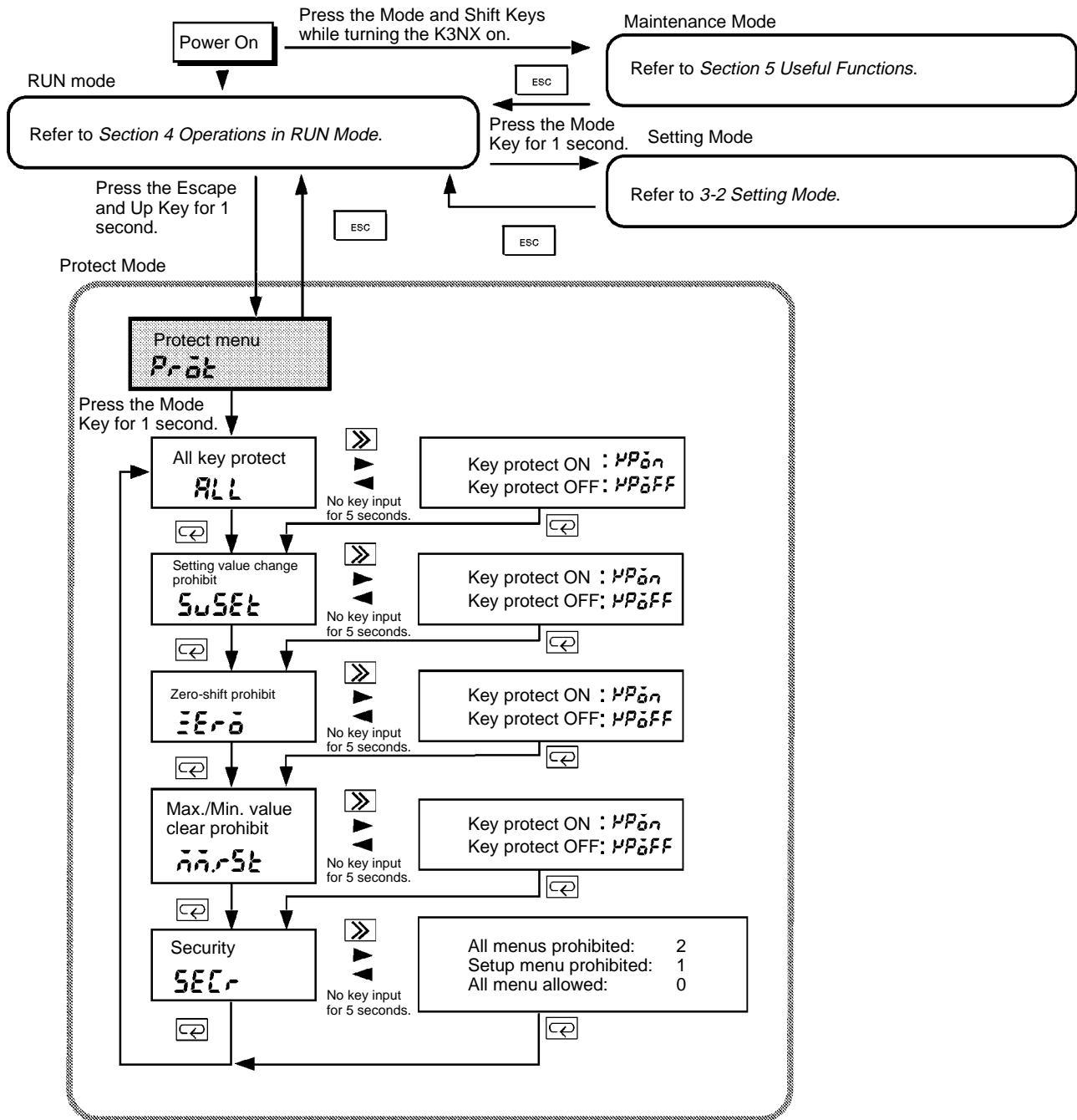

- Note**
1. The K3NX stops measurement in setting mode.
  2. Some menus cannot be set due to the display type or output type selected.

### 3-3-3 Protect Menu (*Pr $\bar{o}$ t*)

**ALL**

#### All Key Protect



FUNCTION



SETTING

- The operation of all keys can be prohibited in the protect menu.

Setting	Default
<i>HP<math>\bar{o}n</math></i> : Key protect ON	<i>HP<math>\bar{o}ff</math></i>
<i>HP<math>\bar{o}ff</math></i> : Key protect OFF	

**SETTING EXAMPLE**

Follow the steps described below to set the key protect to ON.

Set Value LED Display Model Basic Model

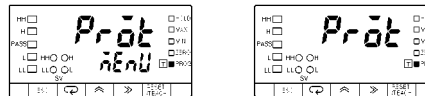

- 1, 2, 3...
- Press the Mode Key for more than one second while the *Pr $\bar{o}$ t* protect menu is displayed. The *ALL* all key protect setting will appear.

Set Value LED Display Model Basic Model

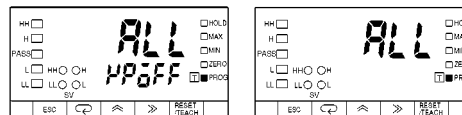

- Press the Shift Key to display the prior setting *HP $\bar{o}ff$*  for changing. The PROG indicator will flash.

Set Value LED Display Model Basic Model

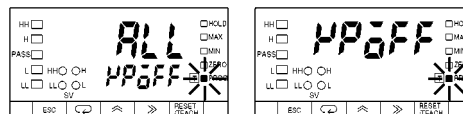

- Press the Up Key to display *HP $\bar{o}n$* . The setting will be validated automatically if no change is made for five seconds. The *ALL* all key protect setting will be displayed again.

**Note** Press the Mode Key to enter the setting immediately. The next parameter will be displayed for setting.

Set Value LED Display Model Basic Model

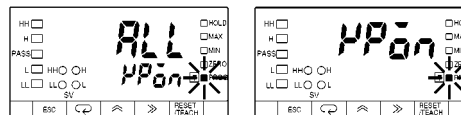

When no operation is executed for five seconds

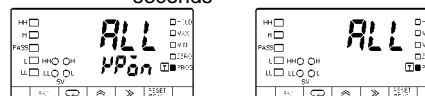

**SuSEt**

**Setting Value Change Prohibit**



FUNCTION



SETTING



REFERENCE

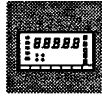

MODELS

- The setting value change of the K3NX in RUN mode with the front panel key inputs can be prohibited in the protect menu.

Setting	Default
HP <sub>ON</sub> : Key protect ON	HP <sub>OFF</sub>
HP <sub>OFF</sub> : Key protect OFF	

Refer to 4-2 Checking and Changing Setting Values.

This setting is only available for the K3NX with the Comparative Output Unit.

**SETTING EXAMPLE**

Follow the steps described below to set the setting value change prohibit to ON.

Set Value LED Display Model      Basic Model

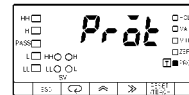
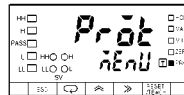

- 1, 2, 3...
1. Press the Mode Key for more than one second while the *Pröt* protect menu is displayed. The *ALL* all key protect setting will appear.

Set Value LED Display Model      Basic Model

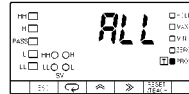
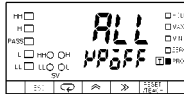

2. Press the Mode Key to display the *SuSEt* setting value prohibit setting.

Set Value LED Display Model      Basic Model

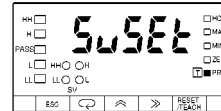
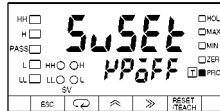

3. Press the Shift Key to display the prior setting *HP<sub>OFF</sub>* for changing. The PROG indicator will flash.

Set Value LED Display Model      Basic Model

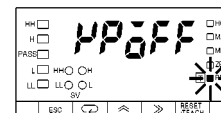
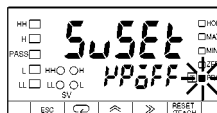

- Press the Up Key to display  $HP\bar{O}n$ . The setting will be validated automatically if no change is made for five seconds. The  $SuSEt$  setting value prohibit setting will be displayed again.

**Note** Press the Mode Key to enter the setting immediately. The next parameter will be displayed for setting.

Set Value LED Display Model      Basic Model

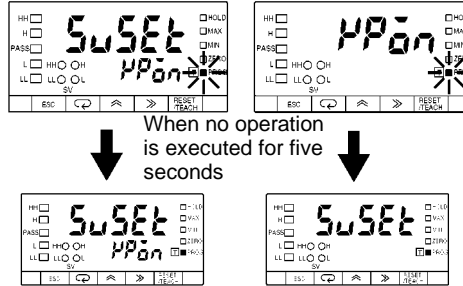



**Forced-zero Prohibit**

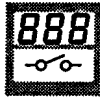

FUNCTION



SETTING



MODELS

- Forced-zero setting with key input can be prohibited in the protect menu. However, forced-zero setting with external signal input is permitted.

Setting	Default
HP <sub>on</sub> : Key protect ON HP <sub>off</sub> : Key protect OFF	HP <sub>off</sub>

Refer to 3 *Forced-zero*.

**SETTING EXAMPLE**

Follow the steps described below to set the forced-zero prohibit to OFF.

Set Value LED Display Model      Basic Model



- 1, 2, 3...
1. Press the Mode Key for more than one second while the *Pröt* protect menu is displayed. The *ALL* all key protect setting will appear.

Set Value LED Display Model      Basic Model

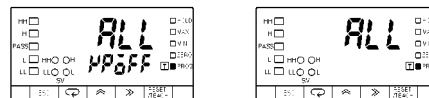

2. Repeatedly press the Mode Key until the  $\Xi E r \bar{o}$  forced-zero prohibit setting is displayed.

Set Value LED Display Model      Basic Model

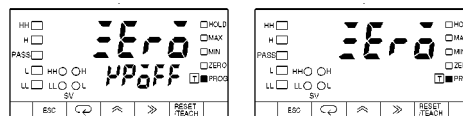

3. Press the Shift Key to display the prior setting *HP<sub>on</sub>* for changing. The PROG indicator will flash.

Set Value LED Display Model      Basic Model

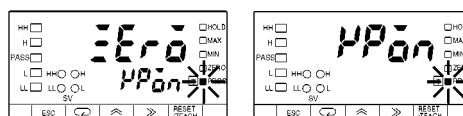

- Press the Up Key to display  $HP\bar{0}FF$ . The setting will be validated automatically if no change is made for five seconds. The  $\bar{E}r\bar{0}$  forced-zero prohibit setting will be displayed again.

**Note** Press the Mode Key to enter the setting immediately. The next parameter will be displayed for setting.

Set Value LED Display Model      Basic Model

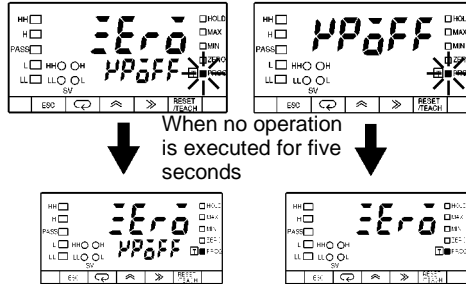

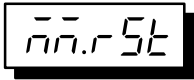

**Maximum/Minimum Value Clear Prohibit**

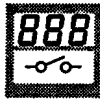

FUNCTION



SETTING

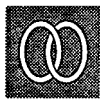

REFERENCE

- The resetting of maximum and minimum values with key input can be prohibited in the protect menu. However, the resetting of maximum and minimum values with external signal input is permitted.

Setting	Default
HP $\bar{0}$ n: Key protect ON	HP $\bar{0}$ FF
HP $\bar{0}$ FF: Key protect OFF	

Refer to 4-3 Checking and Resetting of Maximum and Minimum Values.

**SETTING EXAMPLE**

Follow the steps described below to set the maximum/minimum value clear prohibit to ON.

Set Value LED Display Model      Basic Model



- 1, 2, 3...
- Press the Mode Key for more than one second while the *Pröt* protect menu is displayed. The *ALL* all key protect setting will appear.

Set Value LED Display Model      Basic Model

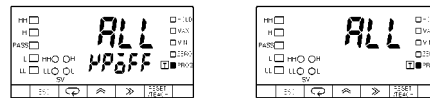

- Repeatedly press the Mode Key until the *n.n.rSt* maximum/minimum value clear prohibit setting is displayed.

Set Value LED Display Model      Basic Model

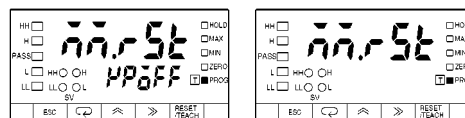

- Press the Shift Key to display the prior setting *HP0FF* for changing. The PROG indicator will flash.

Set Value LED Display Model      Basic Model

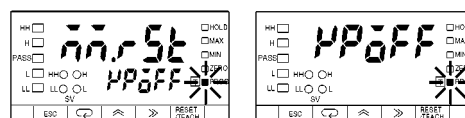



- Press the Up Key to display  $HP\bar{O}n$ . The setting will be validated automatically if no change is made for five seconds. The  $\bar{n}\bar{n}.r.5t$  maximum/minimum value clear prohibit setting will be displayed again.

**Note** Press the Mode Key to enter the setting immediately. The next parameter will be displayed for setting.

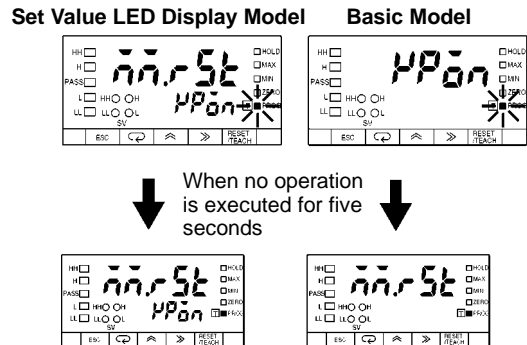



**Security**



FUNCTION



SETTING

- Settings in setting mode can be prohibited in the protect menu.
- The following table shows what set values for menus can be prohibited. The default is 0.

Menu	Set value		
	0	1	2
Setting value			Prohibited
Scaling			Prohibited
Setup		Prohibited	Prohibited
Option			Prohibited

- The value changes in the following order with the Up Key: 0, 1, 2, and 0

**SETTING EXAMPLE**

Follow the steps described below to set the security setting to 1.

Set Value LED Display Model      Basic Model



- 1, 2, 3...
1. Press the Mode Key for more than one second while the *PrOt* protect menu is displayed. The *ALL* all key protect setting will appear.

Set Value LED Display Model      Basic Model

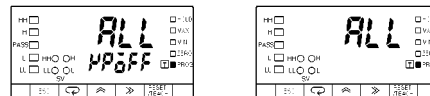

2. Repeatedly press the Mode Key until the *SECr* security setting is displayed.

Set Value LED Display Model      Basic Model

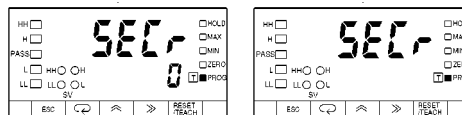

3. Press the Shift Key to display the prior set value *0* for changing. The PROG indicator will flash.

Set Value LED Display Model      Basic Model

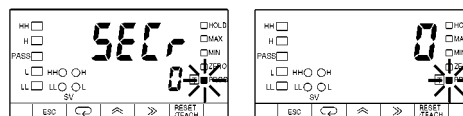

- Press the Up Key to display *!*. The setting will be validated automatically if no change is made for five seconds. The *SECr* security setting will be displayed again.

**Note** Press the Mode Key to enter the setting immediately. The next parameter will be displayed for setting.

**Set Value LED Display Model      Basic Model**

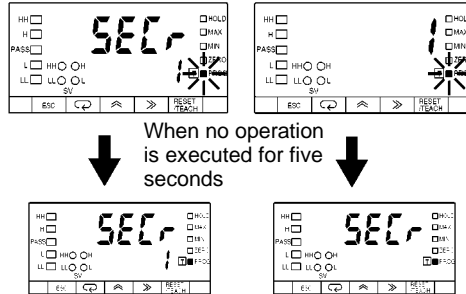

# SECTION 4

## Operations in RUN Mode

This section provides instructions for operating the K3NX in RUN mode.

4-1	Forced-zero .....	68
4-2	Displaying and Changing Setting Values .....	69
4-2-1	Displaying Setting Values .....	69
4-2-2	Changing Setting Values .....	69
4-3	Displaying and Resetting of Maximum and Minimum Values .....	72
4-3-1	Displaying Maximum and Minimum Values .....	72
4-3-2	Resetting Maximum and Minimum Values .....	72
4-4	External Input Signals .....	73
4-4-1	Forced-zero .....	73
4-4-2	RESET .....	73
4-4-3	HOLD .....	74

### 4-1 Forced-zero

- The forced-zero function enables the K3NX to shift the process value to 0, which allows relative object measurement with ease when one of the following is activated in RUN mode.

The RESET/TEACH Key is pressed while the process value is displayed.

The external ZERO input signal is turned ON.

The K3NX receives the forced-zero command through communications.

- The ZERO indicator is lit while the K3NX is in forced-zero state.
- The K3NX retains the forced-zero value even when the power is switched off.
- The process value can be prohibited against change when the forced-zero prohibit setting is ON in protect mode.

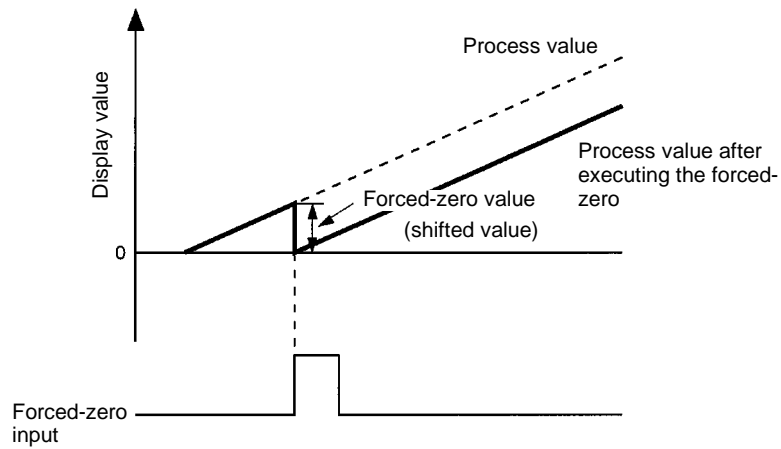

- The following is the relationship between the process value after scaling and display value after the process value is shifted to zero.

$$\text{Display value after executing the forced-zero} = \text{Process value after scaling} - \text{Shifted value}$$

Therefore, if the process value after scaling is shifted to zero, the scaled process value and the display value after executing the forced-zero will not coincide with each other.

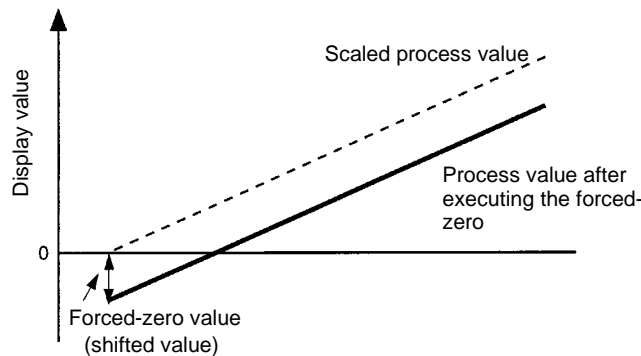

- Forced-zero state will be canceled if one of the following is performed.
  - The RESET/TEACH Key is pressed for longer than one second while the process value is displayed.
  - The K3NX receives the forced-zero cancel command through communications.
  - Two-coordinate input scale (input 1 and input 2) is changed in setting mode.

## 4-2 Displaying and Changing Setting Values

### 4-2-1 Displaying Setting Values

#### Basic Model

- When the Mode Key is pressed in RUN mode, the K3NX displays a setting value on the PV display (in the order of HH, H, L, and LL).
- While the setting value is displayed, the corresponding SV display status indicator is lit.
- Unless another operation key is pressed within five seconds after the setting value is displayed, the process, maximum, or minimum value is displayed again.

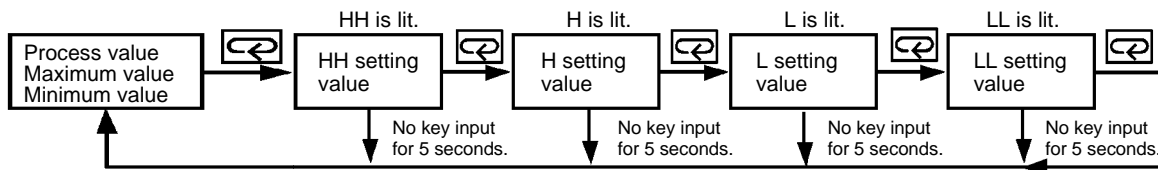

#### Set Value LED Display Model

- The setting value appears on the SV display and the corresponding SV display status indicator is lit while the process, maximum, or minimum value is displayed on the PV display
- When the Mode Key is pressed, the K3NX displays a setting value (in the order of HH, H, L, and LL) on the SV display.

### 4-2-2 Changing Setting Values

- Setting values can be prohibited against change when key protect or setting value change prohibit is ON in protect mode.
- Select the setting value to be changed with the Mode Key.
- All digits will be displayed and ready for changing if the Shift Key is pressed.
- Press the Up and Shift Keys to change the displayed setting value. The input will be entered if nothing else is input within two seconds. The input is entered immediately by pressing the Mode Key.
- The next setting value will be displayed and ready for changing if the Mode Key is pressed. If nothing else is input within two seconds, the setting value will be entered and the previous setting value will be displayed.
- The setting value can be changed through communications if the K3NX is a model with a communications function.

**SETTING EXAMPLE**

**Basic Model**

Follow the steps below to change the H setting value from 600 to 700 while the process value is displayed in RUN mode.

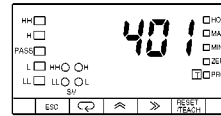

- 1, 2, 3...** 1. Press the Mode Key to display the HH setting value and to light the HH indicator of the SV display status indicators.

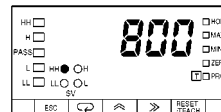

2. Press the Mode Key again to display the H setting value H and light the H indicator.

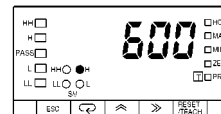

3. Press the Shift Key to display all the digits of the prior setting value 600 for changing.



4. Press the Up and Shift Keys to set the value to 00700.



5. The input will be entered if nothing else is input within five seconds.  
 or Press the Mode Key to display the L setting value for changing. The H setting value will appear again if nothing else is input within five seconds.

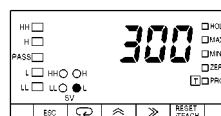

6. To return to the process value display, perform one of the following.
- Repeatedly press the Mode Key until the process value appears.
  - Leave the K3NX with no key input for five seconds.

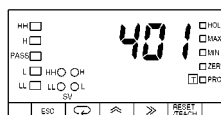

**SETTING  
EXAMPLE**

**Set Value LED Display  
Model**

Follow the steps below to change the H setting value from 600 to 700 while the process value is displayed in RUN mode, provided that the HH setting value is already displayed on the SV display.



- 1, 2, 3...** 1. Press the Mode Key to display the H setting value and to light the H indicator of the SV display status indicators.

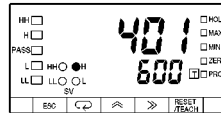

2. Press the Shift Key to display all the digits of the setting value 600 for changing.



3. Press the Up and Shift Keys to set the value to 00700.



4. The input will be entered if nothing else is input within five seconds.  
or Press the Mode Key to display the L setting value for changing. The H setting value will appear again if nothing else is input within five seconds.

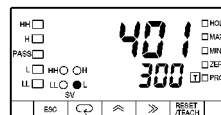



### 4-3 Displaying and Resetting of Maximum and Minimum Values

The maximum and minimum values are refreshed automatically while the K3NX is in measurement operation.

#### 4-3-1 Displaying Maximum and Minimum Values

- The Escape Key is used to select the process, maximum, or minimum value to be displayed on the PV display in RUN mode.
- The corresponding SV display indicator (i.e., the MAX or MIN indicator) is lit while the maximum or minimum value is displayed.

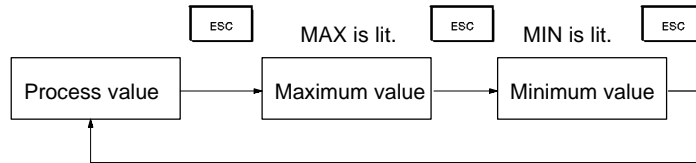

#### 4-3-2 Resetting Maximum and Minimum Values

- The maximum and minimum values are reset when the K3NX is turned on, set to RUN mode, or reset.
- The K3NX will be reset when one of the following is performed.
  - The RESET/TEACH Key is pressed for more than one second while the maximum or minimum value is displayed.
  - The external RESET input signal is turned ON.
  - The K3NX receives the reset command through communications.
- When the K3NX is reset, the maximum and minimum values are set to the process value.

**Note** The K3NX cannot be reset with the RESET/TEACH Key if the maximum/minimum value clear prohibit is ON in protect mode.

**SETTING EXAMPLE**

- 1, 2, 3... 1. The process value 401 is displayed.

Set Value LED Display Model      Basic Model

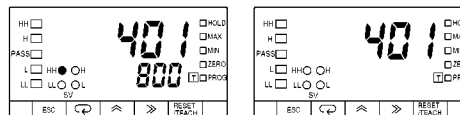

2. Press the Escape Key to display the maximum value 1024 and light the MAX indicator.

Set Value LED Display Model      Basic Model

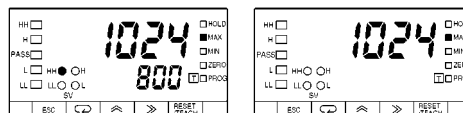

- Press the RESET/TEACH Key to set the maximum and minimum values to the process value 401.

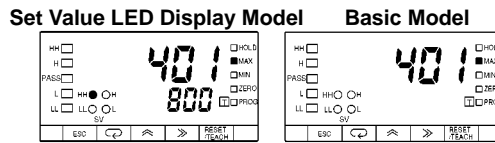

- Press the Escape Key to check that the minimum value is set to 401.

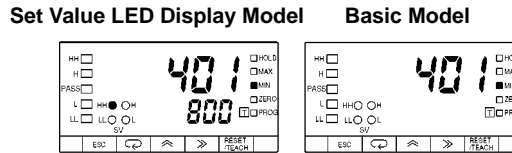

## 4-4 External Input Signals

### 4-4-1 Forced-zero

- Refer to 4-1 *Forced-zero* for the function of this signal.
- The following graph shows the operation timing of the signal.

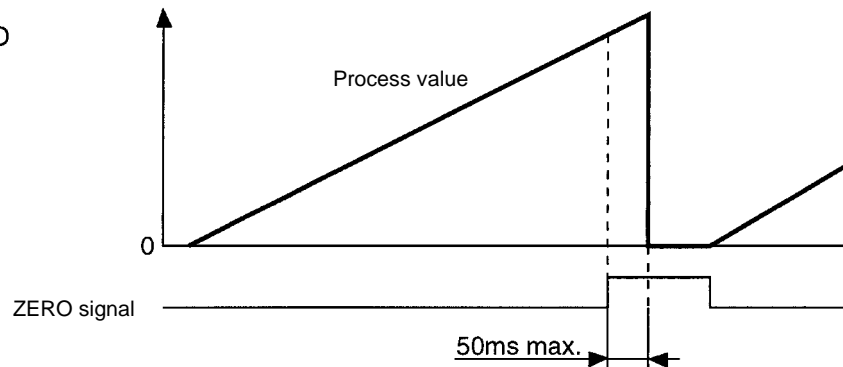
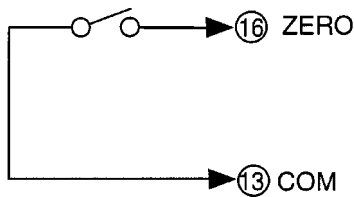

### 4-4-2 RESET

- Refer to 4-3 *Displaying and Resetting of Maximum and Minimum Values* for the function of this signal.
- The following graph shows the operation timing of the signal.

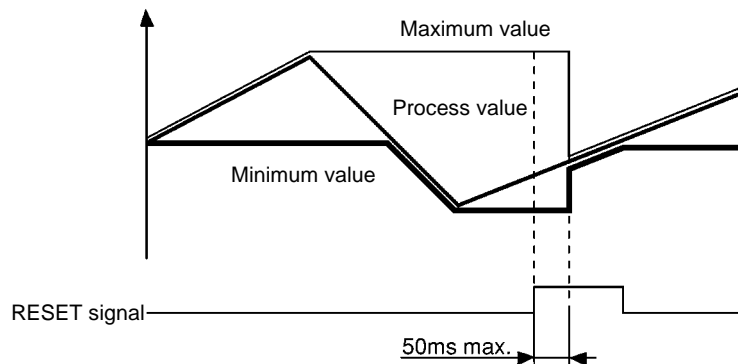
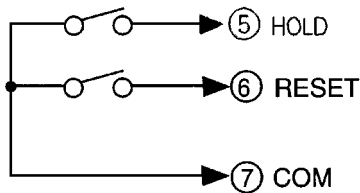

### 4-4-3 HOLD

- The K3NX will stop the measurement if the HOLD input is ON.
- When the HOLD input is ON, the K3NX will retain the process value, output, and BCD data effective immediately before the HOLD input.
- The HOLD indicator is lit while HOLD input is ON.

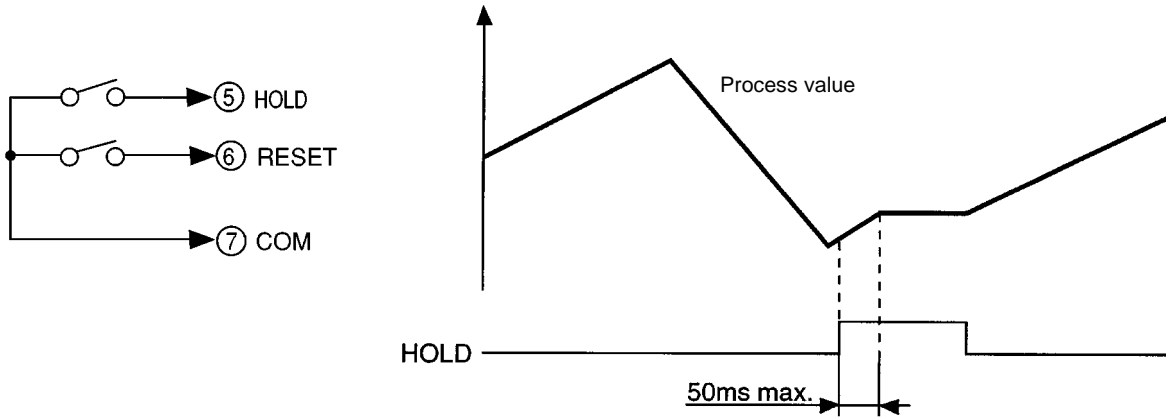

# SECTION 5

## Useful Functions

This section provides information on the teaching function, output test, and maintenance mode.

5-1	Teaching Function .....	76
5-1-1	Set Value .....	76
5-1-2	Scaling Value .....	77
5-1-3	Linear Output Range .....	78
5-2	Output Test .....	79
5-3	Maintenance Mode .....	80
5-3-1	Maintenance Mode .....	80
5-3-2	Initialization .....	80
5-3-3	Field Calibration .....	81
5-3-4	Reference Input Signal .....	82

## 5-1 Teaching Function

- The K3NX is provided with a teaching function that can set an actual measured value as a set value without any front panel key input.

This function is useful for setting parameters while checking the operating status of the K3NX.

- The teaching function can be used to set the setting, scaling values, and linear output range. The TEACH indicator will be lit if a parameter that can use the teaching function is displayed.

### 5-1-1 Set Value

- A setting value can be set with the actual input instead of key input in the setting mode.
- Follow the steps below to teach the setting value.

1, 2, 3...

- Press the RESET/TEACH Key for more than one second while the parameter is displayed. The process value will be displayed and the teaching indicator will flash.
- Press the RESET/TEACH Key again to retrieve the process value immediately before the key was pressed as a set value. The teaching indicator will be lit and the parameter will be displayed. Press the Escape Key to interrupt teaching.

#### SETTING EXAMPLE

Follow the steps described below to set the HH set value by using the teaching function.

Set Value LED Display Model      Basic Model

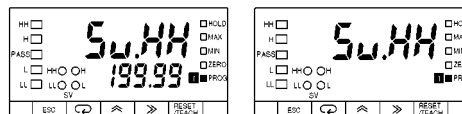

1, 2, 3...

- Press the RESET/TEACH Key for more than one second while the parameter is displayed. The process value will be displayed and the teaching indicator will flash.

Set Value LED Display Model      Basic Model

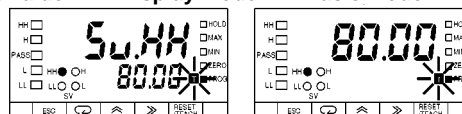

- Press the RESET/TEACH Key again to retrieve the process value immediately before the key was pressed as a set value for changing. The teaching indicator will be lit and the parameter is displayed.

Set Value LED Display Model      Basic Model

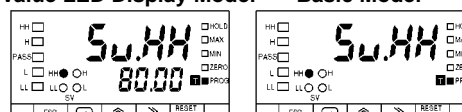

### 5-1-2 Scaling Value

- A scaling input value can be set using the actual measured value instead of key input in the scaling menu.
- Follow the steps below to teach the setting value.

- 1, 2, 3...**
1. Press the RESET/TEACH Key for more than one second while the parameter is displayed. The process value will be displayed and the teaching indicator will flash.
  2. Press the RESET/TEACH Key again to retrieve the process value immediately before the key was pressed as a set value. The teaching indicator will be lit and the parameter will be displayed. Press the Escape Key to interrupt teaching.

**SETTING EXAMPLE**

Follow the steps described below to set the input value 2 by using the teaching function.

Set Value LED Display Model      Basic Model

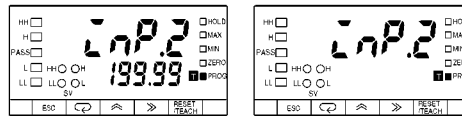

- 1, 2, 3...**
1. Press the RESET/TEACH Key for more than one second while the parameter is displayed. The process value will be displayed and the teaching indicator will flash.

Set Value LED Display Model      Basic Model

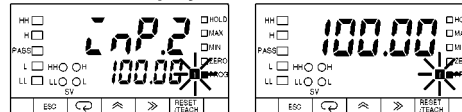

2. Press the RESET/TEACH Key again to retrieve the process value immediately before the key was pressed as a set value for changing. The teaching indicator will be lit and the parameter will be displayed.

Set Value LED Display Model      Basic Model

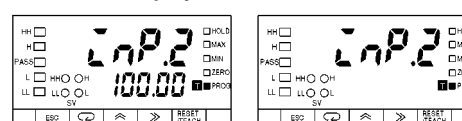

### 5-1-3 Linear Output Range

The teaching function can be also used to set the linear output range of the K3NX with the Linear Output Board.

- The H and L linear output ranges can be set using the actual measured value instead of key input in the option menu.
- Follow the steps below to teach the setting value.

- 1, 2, 3...**
1. Press the RESET/TEACH Key for more than one second while the parameter is displayed. The process value will be displayed and the teaching indicator will flash.
  2. Press the RESET/TEACH Key again to retrieve the process value immediately before the key was pressed as a set value. The teaching indicator will be lit and the parameter will be displayed. Press the Escape Key to interrupt teaching.

**SETTING EXAMPLE**

Follow the steps described below to set the H linear output range by using the teaching function.

Set Value LED Display Model      Basic Model

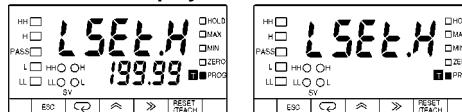

- 1, 2, 3...**
1. Press the RESET/TEACH Key for more than one second while the parameter is displayed. The process value will be displayed and the teaching indicator will flash.

Set Value LED Display Model      Basic Model

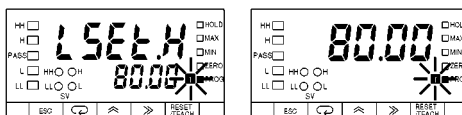

2. Press the RESET/TEACH Key again to retrieve the process value immediately before the key was pressed as a set value for changing. The teaching indicator will be lit and the parameter will be displayed. Press the Escape Key to interrupt teaching.

Set Value LED Display Model      Basic Model

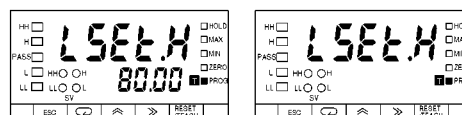

## 5-2 Output Test

This function is convenient for checking a system to which the K3NX is connected, especially when some inputs cannot be operated. The K3NX simulates an input signal to check the output conditions.

**Note** The K3NX has output according to the simulated input in this mode. If there is any device connected to the output of the K3NX, be sure that the output will not have a negative influence on the device before testing the system.

- Follow the steps described below to perform the test.

- 1, 2, 3... 1. While the K3NX is in RUN mode, press the Mode Key for more than one second to set the K3NX to the setting mode.
2. Repeatedly press the Mode Key until `TEST` output test setting is displayed.

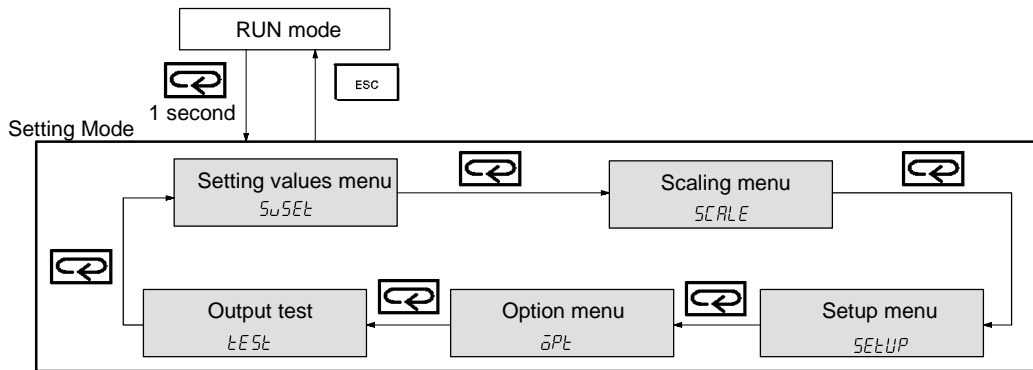

3. Press the Mode Key for more than one second to display 0, which is a simulated input value.
  4. The simulated input value increases when the Up Key is pressed. Comparative outputs are output according to the output pattern that has been preset.
  5. The simulated input value decreases when the Shift Key is pressed. Comparative outputs are output according to the output pattern that has been preset.
  6. Press the Escape Key after testing. The `TEST` output test setting will be displayed again.
  7. Press the Escape Key to return to the RUN mode.
- To change the simulated input value continuously, keep pressing the Up or Shift Key.



## 5-3 Maintenance Mode

The set values of the K3NX can be initialized and field calibration of the K3NX is possible in maintenance mode. The operations of the K3NX in this mode are described below.

### 5-3-1 Maintenance Mode

- The K3NX will be in maintenance mode if the Mode and Shift Keys are pressed simultaneously while the K3NX is turned on.
- The K3NX in maintenance mode will go into RUN mode if the Escape Key is pressed.

Press the Mode and Shift Keys while turning the K3NX on.

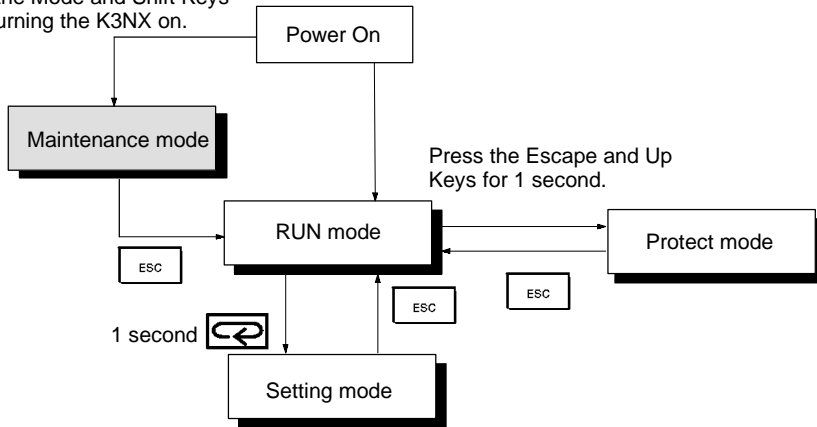

### 5-3-2 Initialization

Follow the steps described below to reset the set values of the K3NX to factory-set values.

- 1, 2, 3... 1. Press the Mode and Shift Keys simultaneously while turning the K3NX on. The  $\bar{n}A_{nt}$  maintenance mode setting will be displayed.

Set Value LED Display Model Basic Model

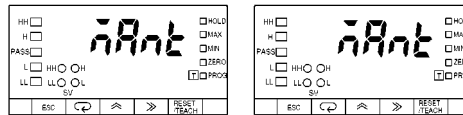

2. Press the Mode Key for more than one second. The  $rE-\bar{L}n$  initialization setting will be displayed.

Set Value LED Display Model Basic Model

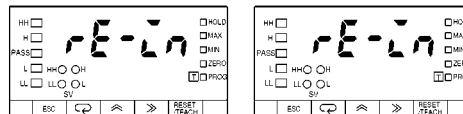

3. Press the Up Key to display  $n\bar{o}$ .

Set Value LED Display Model Basic Model

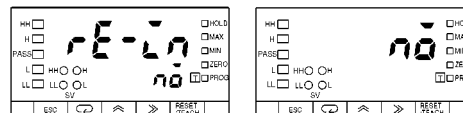

- Press the Up Key to display *YES*. Press the Mode Key to initialize all set values. The K3NX will go into RUN mode.

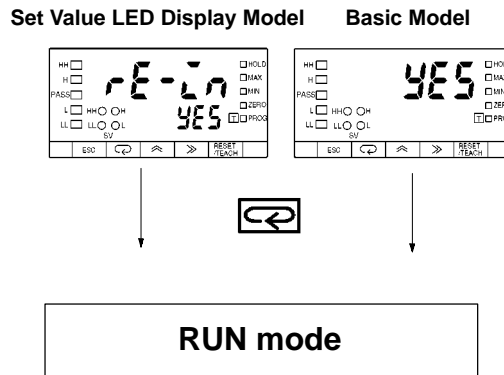

### 5-3-3 Field Calibration

Calibration is to be performed when adjustment is required for display accuracy exceeding the specified value. Follow the procedure below when calibration is required.

Be sure to conduct an accuracy test after calibration.

#### Preparation

Connect an STV (standard voltage/current generator) to the measurement input terminals.

Connect an STV to input terminal 1, 2, or 3 according to the input range.

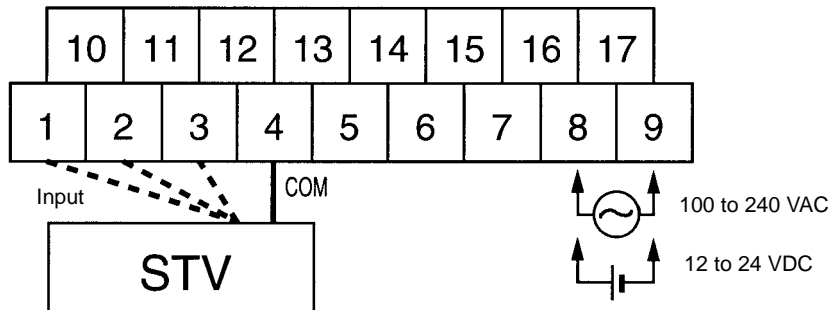

#### Calibration

Perform calibration for each range.

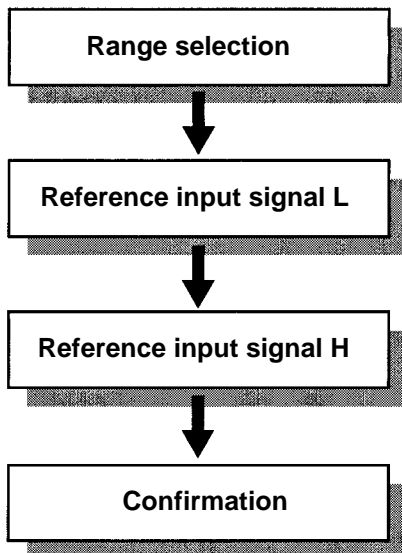

Select the input range

Input reference input signal L for calibration from the STV. The reference signal varies with the input range.

Input reference input signal H for calibration from the STV. The reference signal varies with the input range.

Determine whether the factory-set data should be overwritten with new data.

### 5-3-4 Reference Input Signal

The following are the reference signals for all input ranges.

Input type	Input range	Reference input signal L	Reference input signal H	Input terminals
DC voltage input	$R_{ud}$	0.00 V	199.99 V	1 and 4
	$b_{ud}$	0.000 V	19.999 V	2 and 4
	$E_{ud}$	0.0000 V	1.9999 V	3 and 4
	$d_{ud}$	0.00 mV	199.99 mV	3 and 4
	$E_{ud}$	1.0000 V	5.0000 V	2 and 4
DC current input	$R_{Rd}$	0.00 mA	199.99 mA	1 and 4
	$b_{Rd}$	0.000 mA	19.999 mA	2 and 4
	$E_{Rd}$	0.0000 mA	1.9999 mA	3 and 4
	$d_{Rd}$	4.000 mA	20.000 mA	2 and 4
AC voltage input	$R_{uR}$	0.0 V	400.0 V	1 and 4
	$b_{uR}$	0.00 V	199.99 V	1 and 4
	$E_{uR}$	0.000 V	19.999 V	2 and 4
	$d_{uR}$	0.0000 V	1.9999 A	3 and 4
AC current input	$R_{RR}$	0.000 A	10.000 A	1 and 4
	$b_{RR}$	0.0000 A	1.9999 A	1 and 4
	$E_{RR}$	0.00 mA	199.99 mA	2 and 4
	$d_{RR}$	0.000 mA	19.999 mA	3 and 4

**SETTING EXAMPLE**

Follow the steps described below to calibrate the input range  $E_{ud}$ .

Set Value LED Display Model      Basic Model

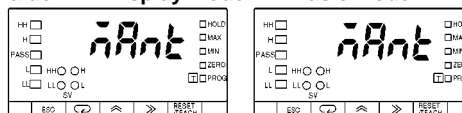

- 1, 2, 3... 1. Press the Mode Key for more than one second while the  $mAnt$  maintenance mode setting is displayed. The  $rE_{un}$  initialization setting will be displayed.

Set Value LED Display Model      Basic Model

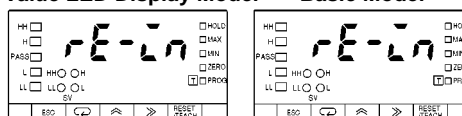

2. Press the Mode Key to display the  $CaLcb$  field calibration setting.

Set Value LED Display Model      Basic Model

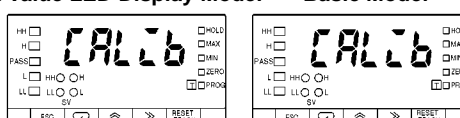

3. Press the Shift Key so that the K3NX will be ready for the field calibration.

Set Value LED Display Model      Basic Model

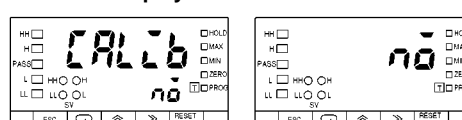

- Press the Up Key to display *YES* and press the Mode Key.

Set Value LED Display Model      Basic Model

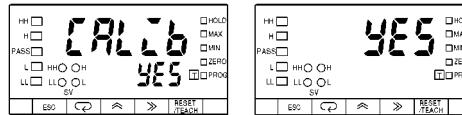

- The warning message *SURE* will be displayed if field calibration is performed for the first time. OMRON does not guarantee the results of field calibration. This warning message will not be displayed the next time field calibration is performed on the K3NX.

Set Value LED Display Model      Basic Model

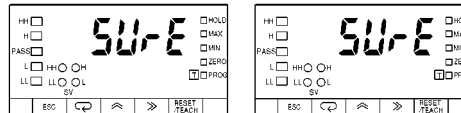

- Press the Mode Key to display the *Ln-t* input range setting.

Set Value LED Display Model      Basic Model

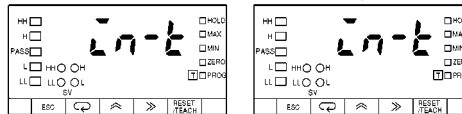

- Press the Shift Key so that the K3NX will be ready for the input range.

Set Value LED Display Model      Basic Model

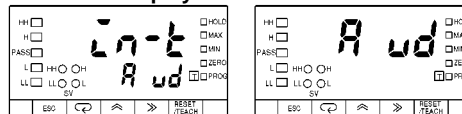

- Press the Up Key and input the range to be calibrated.

Set Value LED Display Model      Basic Model

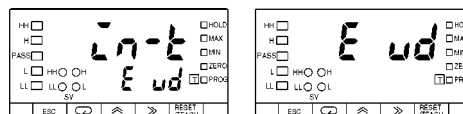

- The teaching indicator will be lit and *LrEF* will be displayed for reference input signal L.

Set Value LED Display Model      Basic Model

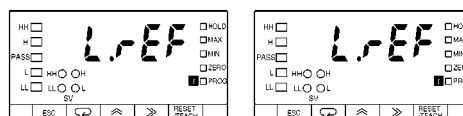

- Press the RESET/TEACH Key and input 1.0000 V as reference input signal L. The teaching indicator will flash.

Set Value LED Display Model      Basic Model

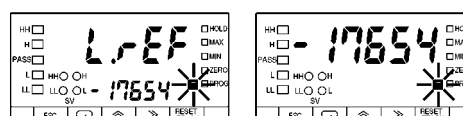

- The process value will be displayed. Press the Mode Key to enter the process value as calibration data.

Set Value LED Display Model Basic Model

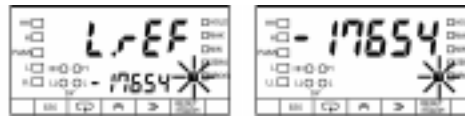

- The *H.rEF* reference input signal H setting will be displayed.

Set Value LED Display Model Basic Model

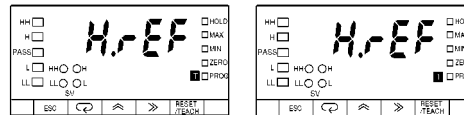

- Press the RESET/TEACH Key and input 5.0000 V as reference input signal H.

- The process value will be displayed. Press the Mode Key to enter the process value as calibration data.

Set Value LED Display Model Basic Model

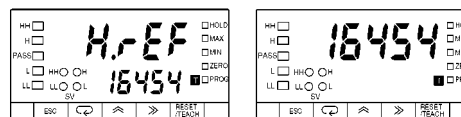

- The prompt *5tr* will be displayed for confirmation of the input.

Set Value LED Display Model Basic Model

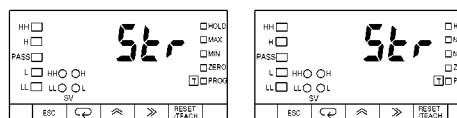

- Press the Shift Key to answer the prompt.

Set Value LED Display Model Basic Model

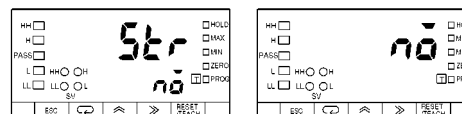

- Press the Up Key to display *YES*.

Set Value LED Display Model Basic Model

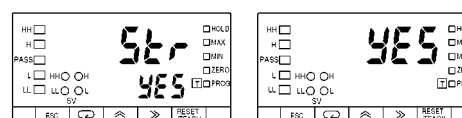

- Press the Mode Key to overwrite the calibration data and put the K3NX in RUN Mode. If *no* is selected, the calibration data will not be overwritten.

# SECTION 6

## BCD Output

This section provides information on the use of the K3NX with the BCD Output Board.

6-1	Connectors .....	86
6-2	Timing Charts .....	89

## 6-1 Connectors

### Terminal Arrangement

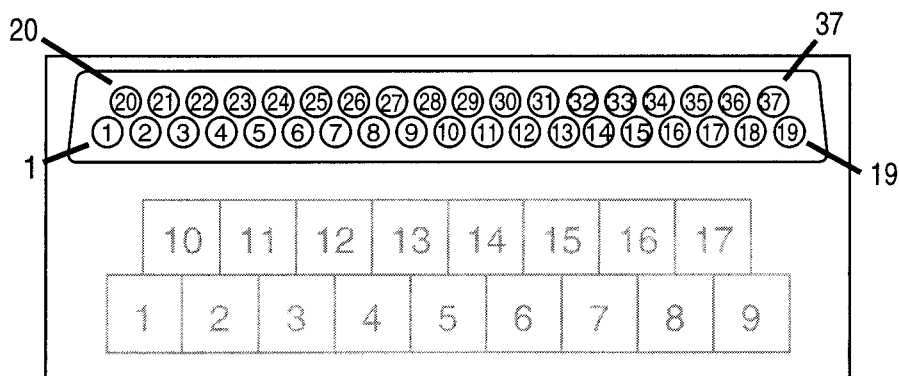

Terminal number	Signal name	Signal direction	Use
1	COM	---	GND:VO (See note 1.)
2	RD1-1	Output	1: Read data $10^0$ digit
3	RD1-2	Output	2: Read data $10^0$ digit
4	RD1-4	Output	4: Read data $10^0$ digit
5	RD1-8	Output	8: Read data $10^0$ digit
6	RD2-1	Output	1: Read data $10^1$ digit
7	RD2-2	Output	2: Read data $10^1$ digit
8	RD2-4	Output	4: Read data $10^1$ digit
9	RD2-8	Output	8: Read data $10^1$ digit
10	RD3-1	Output	1: Read data $10^2$ digit
11	RD3-2	Output	2: Read data $10^2$ digit
12	RD3-4	Output	4: Read data $10^2$ digit
13	RD3-8	Output	8: Read data $10^2$ digit
14	RD4-1	Output	1: Read data $10^3$ digit
15	RD4-2	Output	2: Read data $10^3$ digit
16	RD4-4	Output	4: Read data $10^3$ digit
17	RD4-8	Output	8: Read data $10^3$ digit
18	RD5-1	Output	1: Read data $10^4$ digit
19	RD5-2	Output	2: Read data $10^4$ digit
20	RD5-4	Output	4: Read data $10^4$ digit
21	RD5-8	Output	8: Read data $10^4$ digit
22	OVER	Output	Output when input value is not within the display range.
23	D - V	Output	Data confirmation signal
24	RUN	Output	Operation signal
25	COM	---	GND:VO (See note 1.)
26	REQ	Input	PV output request
27	MAX REQ	Input	Maximum value output request
28	MIN REQ	Input	Minimum value output request
29	HOLD	Input	Hold input
30	RESET	Input	Reset input
31	POL	Output	Positive/Negative polarity signal
32	HH	Output	HH output (See note 2.)
33	H	Output	H output (See note 2.)
34	PASS	Output	PASS output (See note 2.)
35	L	Output	L output (See note 2.)

Terminal number	Signal name	Signal direction	Use
36	LL	Output	LL output (See note 2.)
37	COM	Output	GND:VO (See note 1.)

- Note**
1. Terminals 1, 25, and 37 have the same COM.
  2. Refer to *2-3 Output Board* for comparative outputs.

### Applicable Connectors

Use the connector provided with the K3NX or an equivalent connector for the cable connecting to the BCD output connector.

The following connectors are provided with the K3NX.

Plug: XM2A-3701 (OMRON)

Hood: XM2S-3711 (OMRON)

The depth required for the installation of the K3NX is 200 mm min. in consideration of the space required by the cable.

### Connecting Conditions

Refer to the following for the connecting conditions of each I/O. Refer to *2-3 Output Block* for output signals HH through LL.

- Input

Input current with no voltage input: 10 mA

Signal level

ON voltage: 1.5 V max.

OFF voltage: 3 V min.

- Output

Rated load voltage: 24 VDC

Rated load current: 10 mA

Current leakage: 10  $\mu$ A max.



Connection Example

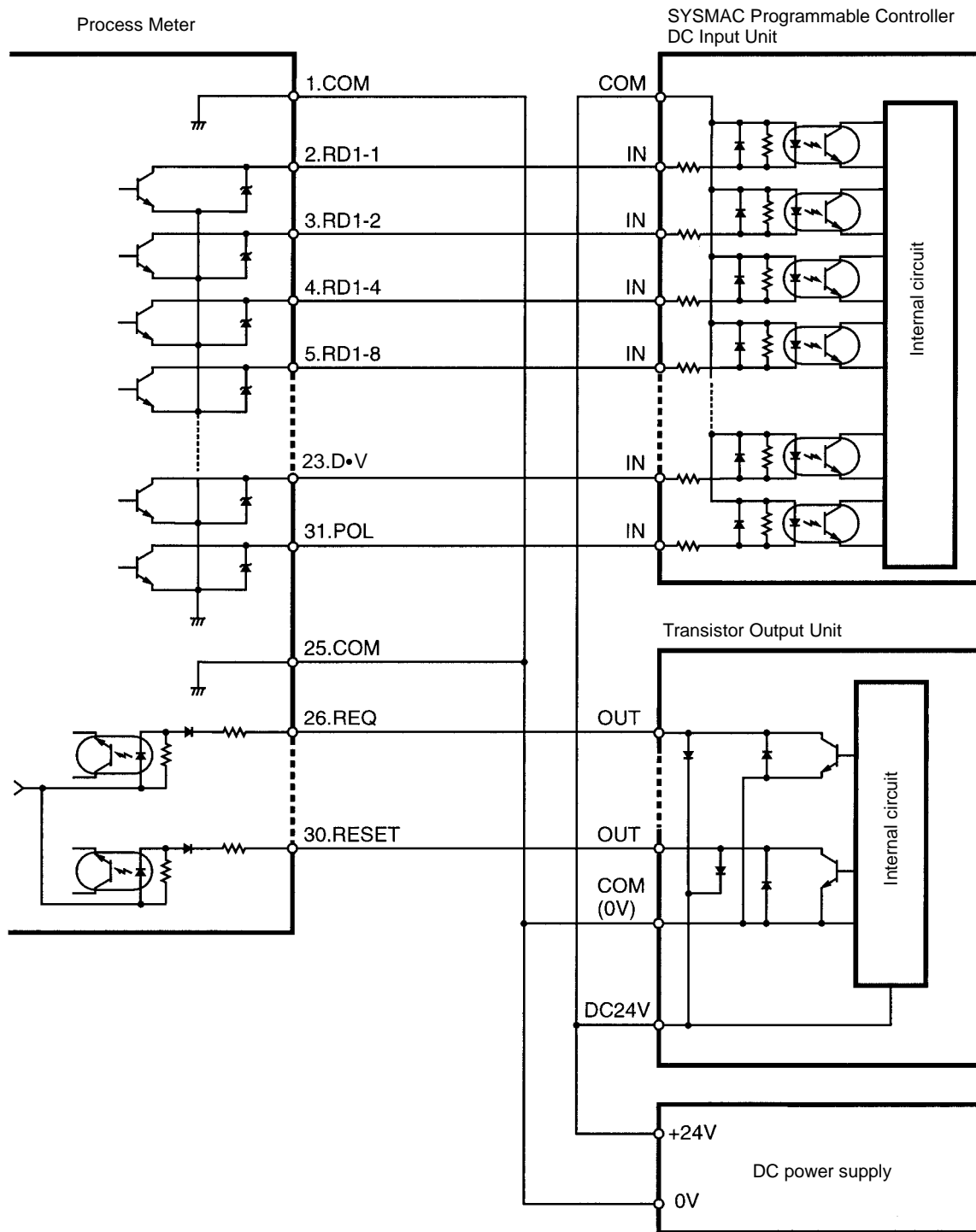

- Note**
1. Connect RD2-1 through RD2-4, RS3-1 through RS3-4, RD4-1 through RD4-4, and RD5-1 through RD5-4 in the same way as RD1-1 through RD1-4.
  2. Connect the RUN and OVER signals if they are used as status data.

Signals

When the HOLD signal is ON, the measurement operation stops and the process value input effective immediately before the HOLD signal is retained.

When the RESET signal is ON, the maximum and minimum values are set to the process value.

The OVER signal is ON when the input value is not within the display range.

The process value is output when the MAXREQ or MINREQ signal is ON at the time the output is tested in output test.

Multiple input signals must not turn ON. If multiple input signals turn ON or a single signal input is combined with another signal input, all output data will be turned OFF.

## 6-2 Timing Charts

When a REQ signal is input from a Programmable Controller to the K3NX in RUN or output test, the K3NX outputs a DATA VALID (D•V) signal. In other cases, the K3NX has All Signals OFF (H) output.

Refer to the following for the timing of each signal.

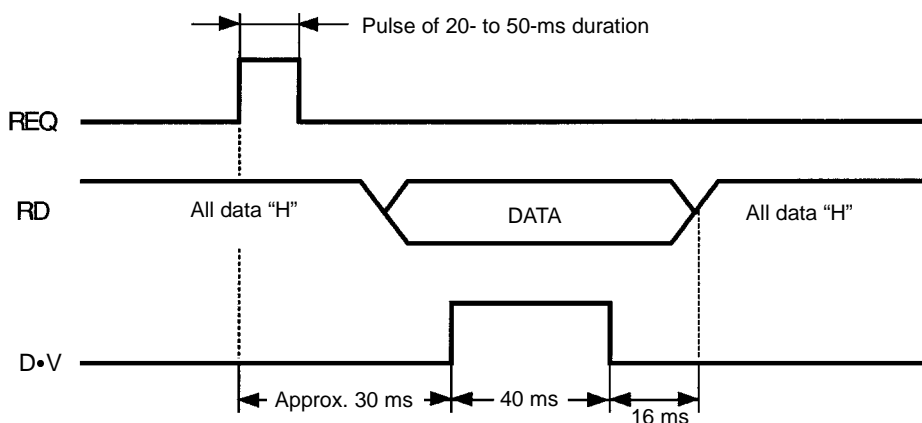

The REQ signal must be kept ON as shown below if the K3NX has continuous data output.

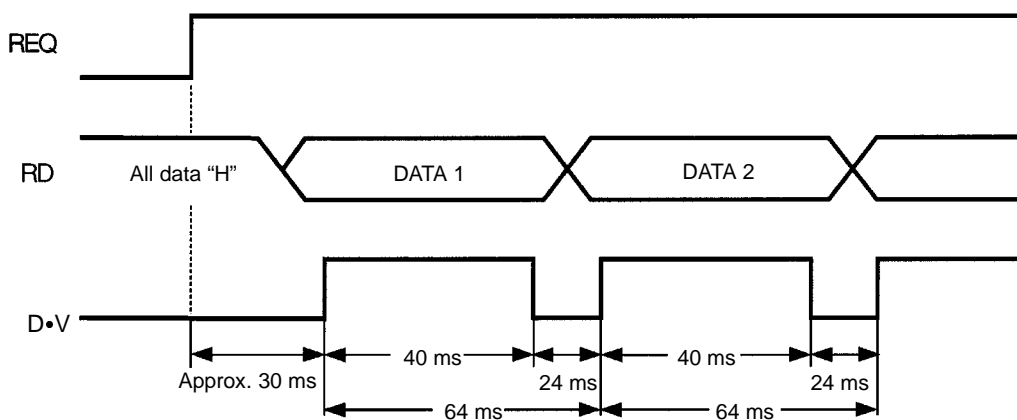

The polarity of the data must be checked with a POLARITY signal. The polarity is positive when the POLARITY signal is OFF and negative when the POLARITY signal is ON.

The K3NX in output test has test data output regardless of the type of REQ signal.

### Operating Conditions

The RUN signal is turned ON in RUN or output test. The RUN signal is, however, turned OFF when an error other than overflow results.

Do not input multiple signals, otherwise all output data will be turned OFF.

# SECTION 7

## Troubleshooting

This section provides information for troubleshooting the K3NX.

7-1	Items to Be Checked First .....	92
7-2	Display .....	92
7-2-1	Flashing .....	92
7-2-2	Error Message .....	92

## 7-1 Items to Be Checked First

First, check the following three items if the K3NX has any problems during operation.

1, 2, 3...

### 1. Power Supply

Be sure that power supplied to the K3NX is within the rated voltage range.

### 2. Wiring

Be sure that the K3NX is wired correctly.

### 3. Communications Conditions

If the model is a K3NX with the Communications Output Board, be sure that the baud rate and unit numbers are correct.

After checking and remedying the above items, if the K3NX still has problems during operation, check the error message.

## 7-2 Display

### 7-2-1 Flashing

The display will flash in the following cases.

- The input or process value is not within the display range.

If the display flashes the output status will be as follows:

Models with BCD Output Board: The OVER signal will be ON.

Models with Communications Output Board: The OVER or UNDER signal will be ON and other output signals will be retained.

- The display will flash for three seconds if an attempt is made to change a setting on the K3NX. Set to remote programming to accept key input.

### 7-2-2 Error Message

The error condition can be checked with the error message.

The K3NX will have the following output statuses when an error message is displayed.

- HH, H, PASS, L, and LL will all be OFF.
- Linear output will be limited to the minimum value.
- The type of BCD output will be All Outputs OFF (H).
- The Unit error response will be returned from the model with a communications function.

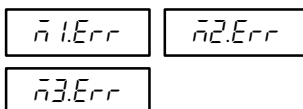

#### Memory Error

##### Meaning of Error

The internal memory has an error.

##### Remedy

Turn the K3NX off and on. If the memory error still exists, the K3NX will need to be repaired. If the K3NX returns to normal operation, the K3NX may have been affected by noise. Check if there is any source of noise generation near the K3NX.

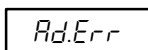

#### AD Converter Error

##### Meaning of Error

The internal circuit has an error.

##### Remedy

Turn the K3NX off and on. If the AD converter error still exists, the K3NX will need to be repaired. If the K3NX returns to normal operation, the K3NX may have been affected by noise. Check if there is any source of noise generation near the K3NX.

CHG- $\bar{a}$
----------------

**Output Error****Meaning of Error**

This message is displayed when the Power is turned ON after an Output Unit is mounted or replaced.

It is also displayed when there is an error in the internal circuitry.

**Remedy**

Press the Mode Key for less than 1 second. The K3N□ should enter RUN mode. In this case, a malfunction has not occurred.

If CHG- $\bar{a}$  continues to be displayed, turn the power OFF and ON again. If the K3N□ still fails to enter RUN mode, repairs are necessary. It is possible that noise has caused faulty operation.

Err- $\bar{a}$
----------------

**Meaning of Error**

This message will be displayed when the power is turned ON and either an incompatible Output Unit has been mounted on the K3N□ or an Output Unit has not been mounted on the K3N□ with set value LED display.

It is also displayed when there is an error in the internal circuitry.

**Remedy**

Check that the Output Unit is compatible, and if it is not, turn OFF the power and replace it with a compatible one. If an Output Unit is not mounted on the K3N□ with set value LED display, turn OFF the power and mount a compatible Unit.

When the power is turned ON again, CHG- $\bar{a}$  will be displayed. If the Mode Key is pressed for less than 1 second, the K3N□ should enter RUN mode. In this case, a malfunction has not occurred.

If Err- $\bar{a}$  or CHG- $\bar{a}$  is still displayed, turn the power OFF and ON again. If the K3N□ still fails to enter RUN mode, repairs are necessary. It is possible that noise has caused faulty operation.

# Appendix A Specifications

## Ratings

<b>Supply voltage</b>	100 to 240 VAC (50/60 Hz); 12 to 24 VDC
<b>Operating voltage range</b>	85% to 110% of supply voltage
<b>Power consumption (see note)</b>	15 VA max. (max. AC load with all indicators lit) 10 W max. (max. DC load with all indicators lit)
<b>Sensor power supply</b>	80 mA at 12 VDC $\pm$ 10% (Use a power supply of less than 50 VAC or 70 VDC for input signals.)
<b>Insulation resistance</b>	20 M $\Omega$ min. (at 500 VDC) between external terminal and case. Insulation provided between inputs, outputs, and power supply.
<b>Dielectric withstand voltage</b>	2,000 VAC for 1 min between external terminal and case. Insulation provided between inputs, outputs, and power supply.
<b>Noise immunity</b>	$\pm$ 1,500 V on power supply terminals in normal or common mode $\pm$ 1 $\mu$ s, 100 ns for square-wave noise with 1 ns
<b>Vibration resistance</b>	Malfunction: 10 to 55 Hz, 0.5-mm for 10 min each in X, Y, and Z directions Destruction: 10 to 55 Hz, 0.75-mm for 2 hrs each in X, Y, and Z directions
<b>Shock resistance</b>	Malfunction: 98 m/s <sup>2</sup> (10G) for 3 times each in X, Y, and Z directions Destruction: 294 m/s <sup>2</sup> (30G) for 3 times each in X, Y, and Z directions
<b>Ambient temperature</b>	Operating: -10°C to 55°C (with no icing) Storage: -20°C to 65°C (with no icing)
<b>Ambient humidity</b>	Operating: 25% to 85% (with no condensation)
<b>Ambient atmosphere</b>	Must be free of corrosive gas
<b>EMC</b>	Emission Enclosure: EN55011 Group 1 class A Emission AC Mains: EN55011 Group 1 class A Immunity ESD: EN61000-4-2: 4-kV contact discharge (level 2) 8-kV air discharge (level 3) Immunity-RF-interference: ENV50140: 10 V/m (amplitude modulated, 80 MHz to 1 GHz) (level 3) 10 V/m (pulse modulated, 900 MHz) Immunity Conducted Disturbance: ENV50141: 10 V (0.15 to 80 MHz) (level 3) Immunity Burst: EN61000-4-4: 2-kV power-line (level 3) 2-kV I/O signal-line (level 4)
<b>Approved standards</b>	UL508, CSA22.2; conforms to EN50081-2, EN50082-2, EN61010-1 (IEC1010-1); conforms to VDE106/part 100 (Finger Protection) when the terminal cover is mounted.
<b>Weight</b>	Approx. 400 g

**Note** An Intelligent Signal Processor with DC supply voltage requires approximately 1 A DC as control power supply current the moment the Intelligent Signal Processor is turned on. Do not forget to take this into consideration when using several Intelligent Signal Processors. When the Intelligent Signal Processor is not in measuring operation (e.g., the Intelligent Signal Processor has been just turned on or is operating for start-up compensation time), the display will read "00000" and all outputs will be OFF.

## Input/Output Ratings

### Relay Contact Output

(Incorporating a G6B Relay)

Item	Resistive load ( $\cos\phi = 1$ )	Inductive load ( $\cos\phi = 0.4$ , $L/R = 7$ ms)
Rated load	5 A at 250 VAC; 5 A at 30 VDC	1.5 A at 250 VAC, 1.5 A at 30 VDC
Rated carry current	5 A max. (at COM terminal)	
Max. contact voltage	380 VAC, 125 VDC	
Max. contact current	5 A max. (at COM terminal)	
Max. switching capacity	1,250 VA, 150 W	375 VA, 80 W
Min. permissible load (P level, reference value)	10 mA at 5 VDC	
Mechanical life	50,000,000 times min. (at a switching frequency of 18,000 times/hr)	
Electrical life (at an ambient temperature of 23°C)	100,000 times min. (at a rated load switching frequency of 1,800 times/hr)	

### Transistor Output

Rated load voltage	12 to 24 VDC $+10\%/_{-15\%}$
Max. load current	50 mA
Leakage current	100 $\mu$ A max.

### BCD Output

I/O signal name		Item	Rating
Inputs	REQUEST, HOLD, MAX, MIN, RESET	Input signal	No-voltage contact input
		Input current with no-voltage input	10 mA
		Signal level	ON voltage: 1.5 V max. OFF voltage: 3 V min.
Outputs	DATA, POLARITY, OVERFLOW, DATA VALID, RUN	Rated load voltage	12 to 24 VDC $+10\%/_{-15\%}$
		Max. load current	10 mA
		Leakage current	100 $\mu$ A max.

**Note** Logic method: negative logic

### Linear Output

Item	4 to 20 mA	1 to 5 V	1 mV/10 digits (see note)
Resolution	4,096		
Output error	$\pm 0.5\%$ FS		$\pm 1.5\%$ FS
Permissible load resistance	600 $\Omega$ max.	500 $\Omega$ min.	1 K $\Omega$ min.

**Note** For the 1 mV/10-digit output, the output voltage changes for every 40 to 50 increment in the display value.

## Communications

Item		RS-232C, RS-422	RS-485
Transmission method		4-wire, half-duplex	2-wire, half-duplex
Synchronization method		Start-stop synchronization	
Baud rate		1,200/2,400/4,800/9,600/19,200/38,400 bps	
Transmission code		ASCII (7-bit)	
Communications	Write to K3NX	Comparative set value, scaling value, remote/local programming, forced zero control, reset control of maximum/minimum values, and other setting mode items excluding communications conditions.	
	Read from K3NX	Process value, comparative set value, maximum value, minimum value, model data, error code, and others	

**Note** For details, refer to *Communication Operation Manual*.

## Characteristics

<b>Input signal</b>	DC voltage/current, AC voltage/current
<b>A/D conversion method</b>	Double integral method
<b>Sampling period</b>	50 Hz: 12.5 times/s; 60 Hz: 15 times/s (selectable)
<b>Display refresh period</b>	Sampling period (sampling times multiplied by number of averaging times if simple average processing is selected.)
<b>Max. displayed digits</b>	5 digits (-19999 to 99999)
<b>Display</b>	7-segment LED
<b>Polarity display</b>	"-" is displayed automatically with a negative input signal.
<b>Zero display</b>	Leading zeros are not displayed.
<b>Scaling function</b>	Programmable with front-panel key inputs (range of display: -19999 to 99999). The decimal point position can be set freely.
<b>HOLD function</b>	Maximum hold (maximum data) Minimum hold (minimum data)
<b>External controls</b>	HOLD: (Process value held) RESET: (Maximum/Minimum data reset) ZERO: (Forced zero)
<b>Comparative output hysteresis setting</b>	Programmable with front-panel key inputs (1 to 9999).
<b>Other functions</b>	Variable linear output range (for models with linear outputs only) Remote/Local processing (available for communications output models only) Maximum/Minimum value data reset with front panel keys Forced-zero set with front panel keys Averaging processing function (simple or moving average) Startup compensation time (0.0 to 99.9 s) Comparative output pattern selection Security Field calibration
<b>Output configuration</b>	Relay contact output (5 outputs) Transistor output (NPN and PNP open collector), BCD (NPN open collector) Parallel BCD (NPN open collector) + transistor output (NPN open collector) Linear output (4 to 20 mA, 1 to 5 V) + transistor output (NPN open collector) Communication functions (RS-232C, RS-485, RS-422) Communication functions (RS-232C, RS-485, RS-422) + transistor output (NPN open collector)
<b>Delay in comparative outputs (transistor output)</b>	DC input: 200 ms max. AC input: 400 ms max.
<b>Enclosure ratings</b>	Front panel: NEMA4 for indoor use (equivalent to IP66) Rear case: IEC standard IP20 Terminals: IEC standard IP00
<b>Memory protection</b>	Non-volatile memory (EEPROM) (possible to rewrite 100,000 times)



## Appendix B



### List of Settings

Menu	Parameter	Setting range	Unit	Set value
<i>SUSET</i> Setting values menu	<i>Su.HH</i> HH set value	-19999 to 99999	---	
	<i>Su. H</i> H set value	-19999 to 99999	---	
	<i>Su. L</i> L set value	-19999 to 99999	---	
	<i>Su.LL</i> LL set value	-19999 to 99999	---	
<i>SCALE</i> Scaling menu	<i>inP.2</i> Input value 2	-19999 to 99999	---	
	<i>dSP.2</i> Display value 2	-19999 to 99999	---	
	<i>inP.1</i> Input value 1	-19999 to 99999	---	
	<i>dSP.1</i> Display value 1	-19999 to 99999	---	
	<i>dEC-P</i> Decimal point position	00000/0.0000/00.000/000.00/0000.0		
<i>SETUP</i> Setup menu	<i>in-r</i> Input range	DC voltage input: <i>R ud</i> to <i>E ud</i> DC current input: <i>R Rd</i> to <i>d Rd</i> AC voltage input: <i>R uR</i> to <i>d uR</i> AC current input: <i>R RR</i> to <i>d RR</i>	---	
	<i>FrE</i> Power supply frequency	50/60	Hz	
	<i>U-no</i> Communications unit no.	00 to 99	---	
	<i>bPS</i> Baud rate	1200/2400/4800/9600/19200/ 38400	bps	
	<i>LEn</i> Word length	7/8	bit	
	<i>Sbct</i> Stop bits	1/2	bit	
	<i>Prty</i> Parity bits	None/Even/Odd	---	
<i>opt</i> Option menu	<i>AUG</i> Average processing	No average processing Movement average processing: 2, 4, 8, 16, or 32 times Simple average processing: 2, 4, 8, 16, or 32 times	---	
	<i>StcNE</i> Startup compensation time	0.0 to 99.9	s	
	<i>HCS</i> Hysteresis	1 to 9999	---	
	<i>C-out</i> Comparative output pattern	Standard output, zone output, or level output	---	
	<i>SLEEtY</i> H linear output range	-19999 to 99999	---	
	<i>SLEEtY</i> L linear output range	-19999 to 99999	---	
	<i>r-L</i> Remote/local programming	Remote or local programming	---	

# Appendix C

## Available Models

### Base Units

Model	Input type	Supply voltage	
		100 to 240 VAC	12 to 24 VDC
<b>Basic Models</b> These models provide a process value LED and front-panel control keys. Can be connected to available Output Board, or can be used for display only without an Output Board. 	DC voltage	K3NX-VD1A	K3NX-VD2A
	DC current	K3NX-AD1A	K3NX-AD2A
	AC voltage	K3NX-VA1A	K3NX-VA2A
	AC current	K3NX-AA1A	K3NX-AA2A
<b>Set Value LED Models</b> These models provide a process value LED, set value LED, and front-panel control keys. Can be connected to Relay Contact, Transistor, or Combination Output Boards. 	DC voltage	K3NX-VD1C	K3NX-VD2C
	DC current	K3NX-AD1C	K3NX-AD2C
	AC voltage	K3NX-VA1C	K3NX-VA2C
	AC current	K3NX-AA1C	K3NX-AA2C

### Available Output Board Combinations

Output type	Output configuration	Output boards	Base units	
			Basic	Set Value LED Display
<b>Relay contact</b>	3 outputs: H, PASS, L (SPDT)	K31-C1	Yes	Yes
	5 outputs: HH, H, L, LL (SPST-NO), and PASS (SPDT)	K31-C2	Yes	Yes
	5 outputs: HH, H, L, LL (SPST-NC), and PASS (SPDT)	K31-C5	Yes	Yes
<b>Transistor</b>	5 outputs (NPN open collector)	K31-T1	Yes	Yes
	5 outputs (PNP open collector)	K31-T2	Yes	Yes
<b>BCD (see note)</b>	5-digit output (NPN open collector)	K31-B2	Yes	---
<b>Linear</b>	4 to 20 mA DC	K31-L1	Yes	---
	1 to 5 VDC	K31-L2	Yes	---
	1 mV/10 digits	K31-L3	Yes	---
	0 to 5 VDC	K31-L7	Yes	---
	0 to 10 VDC	K31-L8	Yes	---
<b>Communication boards (see note)</b>	RS-232C	K31-FLK1	Yes	---
	RS-485	K31-FLK2	Yes	---
	RS-422	K31-FLK3	Yes	---
<b>Combination output and communication boards</b>	BCD output + 5 transistor outputs (NPN open collector)	K31-B4	Yes	Yes
	4 to 20 mA + 5 transistor outputs (NPN open collector)	K31-L4	Yes	Yes
	1 to 5 V + 5 transistor outputs (NPN open collector)	K31-L5	Yes	Yes
	1 mV/10 digits + 5 transistor outputs (NPN open collector)	K31-L6	Yes	Yes
	0 to 5 VDC + 5 transistor outputs (NPN open collector)	K31-L9	Yes	Yes
	0 to 10 VDC + 5 transistor outputs (NPN open collector)	K31-L10	Yes	Yes
	RS-232C + 5 transistor outputs (NPN open collector)	K31-FLK4	Yes	Yes
	RS-485 + 5 transistor outputs (NPN open collector)	K31-FLK5	Yes	Yes
RS-422 + 5 transistor outputs (NPN open collector)	K31-FLK6	Yes	Yes	

**Note** For details, refer to the *Communication Operation Manual*.

## Model Number Legend

Base Units and Output Boards are available individually. Refer to the *Available Output Board Combinations* table on page 101.

### Base Units

K3NX -      
           1   2   3   4

### Output Boards

K31 -      
           5   6   7   8

### 1, 2. Input Sensors Codes

VD: DC voltage input

AD: DC current input

VA: AC voltage input

AA: AC current input

### 3. Supply Voltage

1: 100 to 240 VAC

2: 12 to 24 VDC

### 4. Display

A: Basic

C: Set Value LED Display

### 5, 6, 7, 8. Output Type Codes

C1: 3 comparative relay contact outputs (H, PASS, L: SPDT)

C2: 5 comparative relay contact outputs (HH, H, L, LL: SPST-NO; PASS: SPDT)

C5: 5 comparative relay contact outputs (HH, H, L, LL: SPST-NC; PASS: SPDT)

T1: 5 comparative transistor outputs (NPN open collector)

T2: 5 comparative transistor outputs (PNP open collector)

B2: BCD output (NPN open collector) (see note)

B4: BCD output + 5 transistor outputs (NPN open collector)

L1: Linear output (4 to 20 mA) (see note)

L2: Linear output (1 to 5 VDC) (see note)

L3: Linear output (1 mV/10 digits) (see note)

L4: Linear output, 4 to 20 mA + 5 transistor outputs (NPN open collector)

L5: Linear output, 1 to 5 V + 5 transistor outputs (NPN open collector)

L6: Linear output, 1 mV/10 digits+ 5 transistor outputs (NPN open collector)

L7: Linear output, 0 to 5 VDC (see note)

L8: Linear output, 0 to 10 VDC (see note)

L9: Linear output, 0 to 5 VDC + 5 transistor outputs (NPN open collector)

L10: Linear output, 0 to 10 VDC + 5 transistor outputs (NPN open collector)

FLK1: Communication RS-232C (see note)

FLK2: Communication RS-485 (see note)

FLK3: Communication RS-422 (see note)

FLK4: RS-232C + 5 transistor outputs (NPN open collector)

FLK5: RS-485 + 5 transistor outputs (NPN open collector)

FLK6: RS-422 + 5 transistor outputs (NPN open collector)

**Note** These output types are available on Basic Models only.

# Appendix D

## Available Parameters

Available parameters vary with the output board of the K3NX and are indicated as “YES” in the following table.

### Setting Mode

Menu	Parameter	Output Board							
		No output	C1/C2 /C5/T1 /T2	B2	B4	L1/ L2/ L3/L7/ L8	L4/L5/ L6/L9/ L10	FLK1/ FLK2/ FLK3	FLK4/ FLK5/ FLK6
SEt Setting values menu	Su.HH HH set value		YES (note 1)		YES		YES		YES
	Su.H H set value		YES		YES		YES		YES
	Su.L L set value		YES		YES		YES		YES
	Su.LL LL set value		YES (note 1)		YES		YES		YES
SCALe Scaling menu	inP.2 Input value 2	YES	YES	YES	YES	YES	YES	YES	YES
	dSP.2 Display value 2	YES	YES	YES	YES	YES	YES	YES	YES
	inP.1 Input value 1	YES	YES	YES	YES	YES	YES	YES	YES
	dSP.1 Display value 1	YES	YES	YES	YES	YES	YES	YES	YES
	dEC-P Decimal point position	YES	YES	YES	YES	YES	YES	YES	YES
SEtUP Setup menu	in-r Input range	YES	YES	YES	YES	YES	YES	YES	YES
	FrE Power supply frequency	YES	YES	YES	YES	YES	YES	YES	YES
	U-nō Communications unit no.							YES	YES
	bPS Baud rate							YES	YES
	LEn Word length							YES	YES
	Sbē Stop bits							YES	YES
	PrēY Parity bits							YES	YES
ōPt Option menu	AVG Average processing	YES	YES	YES	YES	YES	YES	YES	YES
	StēnE Startup compensation time	YES	YES	YES	YES	YES	YES	YES	YES
	HYS Hysteresis		YES		YES		YES		YES
	ē-ōUt Comparative output pattern		YES		YES		YES		YES
	LEt.H H linear output range					YES (note 2)	YES (note 2)		
	LEt.L L linear output range					YES (note 2)	YES (note 2)		
	r-L Remote or local programming							YES	YES
tEst Output test			YES	YES	YES	YES	YES	YES	YES

- Note**
1. The HH and LL set values cannot be set with the K31-C1 Output Board.
  2. The linear output range cannot be set with K31-L3 and K31-L6 Output Boards.

## Protect Mode

Menu	Parameter	Output Board								
		No output	C1/C2 /C5/T1 /T2	B2	B4	L1/ L2/ L3	L4/L5/ L6/L7/ L8/L9 L10	FLK1/ FLK2/ FLK3	FLK4/ FLK5/ FLK6	
Protect menu	<i>ALL</i> All key protect	YES	YES	YES	YES	YES	YES	YES	YES	YES
	<i>SSEt</i> Set value change prohibit		YES		YES		YES		YES	
	<i>EErō</i> Forced-zero prohibit	YES	YES	YES	YES	YES	YES	YES	YES	YES
	<i>nn.rSt</i> Maximum/Minimum value clear prohibit	YES	YES	YES	YES	YES	YES	YES	YES	YES
	<i>SEEr</i> Security	YES	YES	YES	YES	YES	YES	YES	YES	YES



With the K3NX-VD□A-C2, the input of 1 to 5 V can be converted and displayed within a range of 0 to 100.00 and can be output as follows according to the following procedure:

- HH output for a display value larger than 100.00
- H output for a display value larger than 80.00
- L output for a display value smaller than 50.00
- LL output for a display value of smaller than 30.00

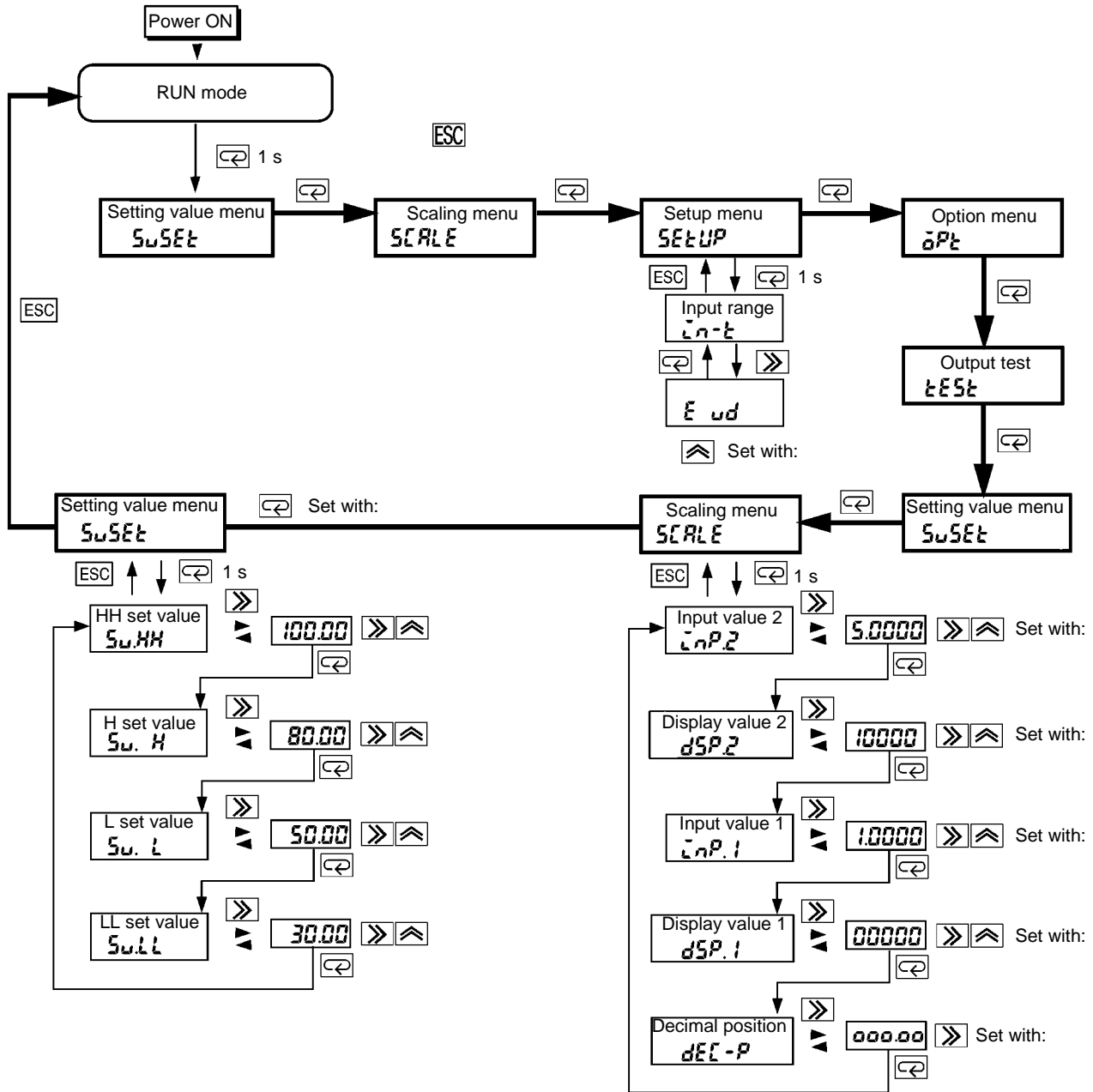

With the K3NX-AA□C-L4, the input of 0 to 10 A can be converted and displayed within a range of 0.000 to 10.000 and can be output in the range of 4 to 20 mA in proportion to the change in display value according to the following conditions.

- Output Pattern Selection: Level output
- LL output for a display value of larger than 4.000
- L output for a display value of larger than 6.000
- H output for a display value of larger than 8.000
- HH output for a display value of larger than 10.000

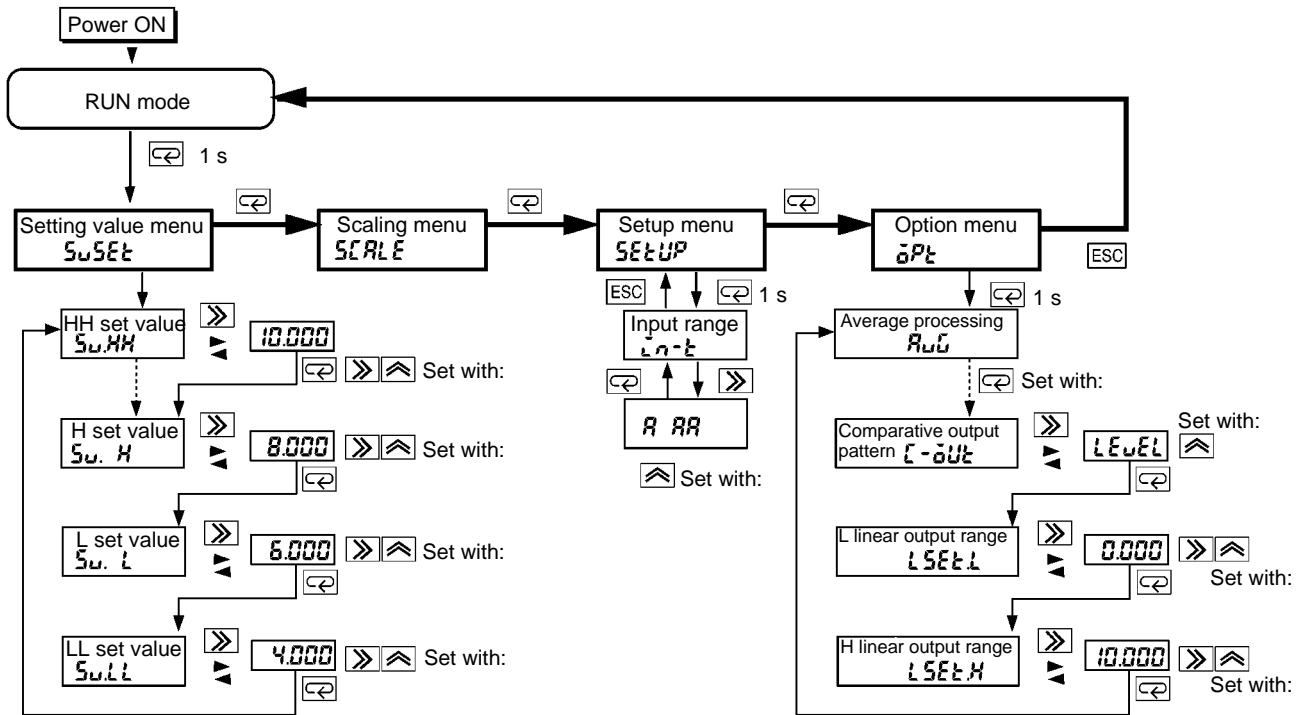



# Index

## A

AD converter error, 92  
All Key Protect, setting, 58  
average processing, description, 3  
average processing, settings, 41

## B

Base Unit, 11  
    available models, 101  
baud rate, setting, 36  
BCD Output Boards  
    connectors, 86  
    operation, 85  
    timing charts, 89  
BCD output boards, 17

## C

calibration, field calibration, 8  
calibration, field calibration, 81  
characteristics, 97  
chattering, preventing, 46  
combination output boards, 17  
communications format, setting, 38  
communications function, 8  
communications unit number, setting, 36  
comparative output pattern, setting, 48  
comparative output selection, description, 2  
comparative outputs, setting, 49

## D–E

dimensions, 10  
display  
    description, 3  
    troubleshooting, 92  
error messages, 92  
examples, setting examples, 105  
external control inputs, 13  
external input signals, operation, 73

## F

field calibration, 8  
field calibration, 81  
flashing display, 92  
forced-zero function, description, 2  
forced-zero function, operation, 68  
Forced-zero Prohibit, setting, 61  
Forced-zero setting, protecting, 61  
forced-zero signal, 73

## H

HOLD input, wiring, 13  
HOLD input, 74  
    description, 2  
host computer, unit number setting, 36  
hysteresis setting, setting, 46  
hysteresis setting, description, 3

## I

indicators, description, 3  
Initialization, of set values, 80  
input range, setting, 32  
input ranges, reference signals, 82

## L

LED indicators, description, 3  
level output, 49  
linear output boards, 17  
linear output range, setting, 51  
linear output range, teaching, 78

## M

Maintenance mode, 8  
Maintenance mode, operation, 80  
maximum values  
    displaying and resetting, 72  
    protecting, 63  
Maximum/Minimum Value Clear Prohibit, setting, 63  
measurement ranges, for inputs, 12

memory error, 92  
menu overview  
  Protect mode, 57  
  Setting mode, 22  
menus  
  option menu, 41  
  protect menu, 58  
  scaling menu, 27  
  setting value menu, 23  
  setup menu, 32  
minimum values  
  displaying and resetting, 72  
  protecting, 63  
model numbers, meaning, 102  
models, standard models, 101  
modes, operating modes, 7  
mounting method, 11

## O

operation keys, description, 3  
option menu, 41  
output board, 14  
Output Boards  
  available models, 101  
  available parameters, 103  
output error, 93  
output test function, description, 2  
output test, operation, 79

## P

panel cutouts, 10  
parameter settings, 19  
  procedures, 20  
parameters  
  available in each Output Board, 103  
  list, 99  
parity bits, setting, 38  
PASS output, 48  
Power Supply, wiring, 12  
power supply frequency, setting, 34  
precautions  
  general, xi  
  wiring, 12  
protect menu, 58  
Protect mode, 8  
Protect mode, 56  
  selecting, 56

## R

reference signals, 82  
relay output boards, 16  
remote/local programming, setting, 54  
remote/local selection, description, 3  
RESET input, wiring, 13  
RESET input, 73  
  description, 2  
RUN mode, 7  
RUN mode, operations, 67

## S

sampling times, setting, 34  
scaling, description, 2  
scaling, settings, 27  
scaling menu, 27  
scaling value, teaching, 77  
Security, setting, 65  
sensor power supply, wiring, 12  
set value, teaching, 76  
set value menu, 23  
set values, 23  
  changing, 69  
  displaying, 69  
  initializing, 80  
  protecting, 59  
  setting ranges, 23  
setting examples, 105  
Setting mode, 8  
Setting mode, 21  
  selecting, 21  
Setting Value Change Prohibit, setting, 59  
settings  
  list, 99  
  protecting, 65  
setup, 9  
setup menu, 32  
Signal Input, wiring, 12  
specifications, 95  
standard models, 101  
standard output, 48  
startup compensation time  
  description, 3  
  setting, 44  
stop bits, setting, 38

## **T**

teaching, description, 2  
teaching function, operation, 76  
terminal arrangement  
  Base Unit, 11  
  BCD Output Boards, 86  
  output board, 14  
terminal arrangement, 6  
timing charts, for BCD Output Boards, 89  
transistor output boards, 17

troubleshooting, 91

## **U-Z**

unit number, setting, 36  
wiring, 12  
word length, setting, 38  
ZERO input, wiring, 13  
ZERO input, 73  
zone output, 49

# Revision History

## K3NX

### Process Meter

### Operation Manual

A manual revision code appears as a suffix to the catalog number on the front cover of the manual.

Cat. No. N90-E3-1  
↑  
Revision code

The following table outlines the changes made to the manual during each revision. Page numbers refer to the previous version.

Revision code	Date	Revised content
N90-E1-1	January 1998	Original production
N90-E3-1	June 1999	<b>Page 93:</b> Revisions to Output Error in 7-2-2. <b>Page 102:</b> Deleted Base Units with Ouput Boards in Model Number Legend.