

C200H Replacement Guide

From C200H to CS1

About this document

This document provides the reference information for replacing C200H PLC systems with CS1 series PLC.

This document does not include precautions and reminders ;please read and understand the important precautions and reminders described on the manuals of PLCs (both of PLC used in the existing system and PLC you will use to replace the existing PLC) before attempting to start operation.

Related Manuals

CPU Units

Man.No.	Model	Manual
W394	CS1G/H-CPU□□H CS1G/H-CPU□□-V1 CS1D-CPU□□H CS1D-CPU□□S CJ1H-CPU□□H-R CJ1G/H-CPU□□H CJ1G-CPU□□P CJ1M/G-CPU□□ NSJ□-□□□□(B)-□□□	CS/CJ/NSJ Series PROGRAMMING MANUAL
W474	CS1G/H-CPU□□H CS1G/H-CPU□□-V1 CS1D-CPU□□H CS1D-CPU□□S CJ1H-CPU□□H-R CJ1G/H-CPU□□H CJ1G-CPU□□P CJ1M/G-CPU□□ NSJ□-□□□□(B)-□□□	CS/CJ/NSJ Series INSTRUCTIONS REFERENCE MANUAL
W342	CS1G/H-CPU□□H CS1G/H-CPU□□-V1 CS1D-CPU□□H CS1D-CPU□□S CS1W-SCU□□-V1 CS1W-SCB□□-V1 CJ1H-CPU□□H-R CJ1G/H-CPU□□H CJ1G-CPU□□P CJ1M/G-CPU□□ CJ1W-SCU□□-V1 CP1H-X□□□□-□ CP1H-XA□□□□-□ CP1H-Y□□□□-□ NSJ□-□□□□(B)-□□□	CS/CJ/CP/NSJ Series Communications Commands REFERENCE MANUAL
W341	CQM1H-PRO01 CQM1-PRO01 C200H-PRO27 CS1W-KS001	CS/CJ Series Programming Consoles OPERATION MANUAL
W339	CS1G/H-CPU□□H CS1G/H-CPU□□-V1	CS Series OPERATION MANUAL
W302	C200HX/HG/HE -CPU□□/□□□□-Z	SYSMAC α INSTALLATION GUIDE
W303	C200HX/HG/HE	SYSMAC α OPERATION MANUAL
W322	C200HX-CPU□□-ZE C200HG-CPU□□-ZE C200HE-CPU□□-ZE	SYSMAC α OPERATION MANUAL
W227	CV500/CV1000 C200H/C1000H/C2000H/ 3G8F5	FINS Commands Reference Manual

Special I/O Units

Man.No.	Model	Manual
W426	CS1W-NC□71 CJ1W-NC□71(-MA)	CS/CJ Series Position Control Units OPERATION MANUAL
W435	CS1W-MCH71 CJ1W-MCH71	CS/CJ series Motion Control Units OPERATION MANUAL
W440	CS1W-FLN22 CJ1W-FLN22(100BASE-TX)	CS/CJ Series FL-net Units OPERATION MANUAL
W336	CS1W-SCB□□-V1 CS1W-SCU□□-V1 CJ1W-SCU□□-V1	CS/CJ Series Serial Communications Boards Serial Communications Units OPERATION MANUAL
W345	CS1W-AD0□□-V1/-AD161 CS1W-DA0□□ CS1W-MAD44 CJ1W-AD0□□-V1/-AD042 CJ1W-DA0□□/-DA042V CJ1W-MAD42	CS/CJ Series Analog I/O Units OPERATION MANUAL
W368	CS1W-PTS□□ CS1W-PTW□□ CS1W-PDC□□ CS1W-PTR□□ CS1W-PPS□□ CS1W-PMV□□ CJ1W-PTS□□ CJ1W-PDC□□ CJ1W-PH41U	CS/CJ Series Analog I/O Units OPERATION MANUAL
W902	CS1W-CT021/041	CS Series High-speed Counter Units OPERATION MANUAL
W378	CS1W-HIO01-V1 CS1W-HCP22-V1 CS1W-HCA22-V1 CS1W-HCA12-V1	CS Series Customizable Counter Units OPERATION MANUAL
W384	CS1W-HIO01 CS1W-HCP22 CS1W-HCA22	CS Series Customizable Counter Units PROGRAMMING MANUAL
W376	CS1W-NC□□□	CS Series Position Control Units OPERATION MANUAL
W359	CS1W-MC□□□-V1	CS Series Motion Control Units OPERATION MANUAL
W124	C200H-TS001/002/101/102	C200H Temperature Sensor Units OPERATION MANUAL
W127	C200H-AD001/-DA001	C200H Analog I/O Units OPERATION GUIDE
W229	C200H-AD002/-DA002	C200H Analog I/O Units OPERATION MANUAL
W325	C200H-AD003 C200H-DA003/-DA004 C200H-MAD01	C200H Analog I/O Units OPERATION MANUAL
W225	C200H-TC001/002/003 C200H-TC101/102/103	C200H Temperature Control Units OPERATION MANUAL
W240	C200H-TV001/002/003 C200H-TV101/102/103	C200H Heat/Cool Temperature Control Units OPERATION MANUAL
W241	C200H-PID01/02/03	C200H PID Control Unit OPERATION MANUAL
W141	C200H-CT001-V1 C200H-CT002	C200H High-speed Counter Units OPERATION MANUAL
W311	C200H-CT021	C200H High-speed Counter Units OPERATION MANUAL
W224	C200H-CP114	C200H Cam Positioner Units OPERATION MANUAL
W334	C200HW-NC113/213/413	C200HW Position Control Units OPERATION MANUAL
W137	C200H-NC111	C200H Position Control Units OPERATION MANUAL
W128	C200H-NC112	C200H Position Control Units OPERATION MANUAL
W166	C200H-NC211	C200H Position Control Units OPERATION MANUAL
W314	C200H-MC221	C200H Motion Control Units OPERATION MANUAL:INTRODUCTION
W315	C200H-MC221	C200H Motion Control Units OPERATION MANUAL:DETAILS
W165	C200H-ASC02	C200H ASCII Units OPERATION MANUAL
W306	C200H-ASC11/21/31	C200H ASCII Units OPERATION MANUAL

Man.No.	Model	Manual
W304	C200HW-COM01 C200HW-COM02-V1 to C200HW-COM06-EV1	C200HW Communication Boards OPERATION MANUAL
W257	CVM1-PRS71	Teaching Box OPERATION MANUAL

Network Communications Units

Man.No.	Model	Manual
W309	CS1W-CLK23 CS1W-CLK21-V1 CJ1W-CLK23 CJ1W-CLK21-V1 C200HW-CLK21 CVM1-CLK21 CQM1H-CLK21 CS1W-RPT0□	Controller Link Units OPERATION MANUAL
W370	CS1W-CLK13 CS1W-CLK12-V1 CVM1-CLK12(H-PCF Cable) CS1W-CLK53 CS1W-CLK52-V1 CVM1-CLK52(GI Cable)	Optical Ring Controller Link Units OPERATION MANUAL
W465	CS1W-EIP21 CJ1W-EIP21 CJ2H-CPU6□-EIP CJ2M-CPU3□	CS/CJ Series EtherNet/IP Units OPERATION MANUAL
W420	CS1W-ETN21 CJ1W-ETN21 (100Base-TX)	CS/CJ Series Ethernet Units OPERATION MANUAL Construction of Networks
W421	CS1W-ETN21 CJ1W-ETN21(100Base-TX)	CS/CJ Series Ethernet Units OPERATION MANUAL Construction of Applications
W456	CS1W-CRM21 CJ1W-CRM21	CS/CJ Series CompoNet Master Units OPERATION MANUAL
W457	CRT1	CRT1 Series CompoNet Slave Units and Repeater Unit OPERATION MANUAL
W380	CS1W-DRM21-V1 CJ1W-DRM21	CS/CJ Series DeviceNet Units OPERATION MANUAL
W267	CS1W/CJ1W/C200HW DRT1/DRT2 GT1 CVM1	DeviceNet OPERATION MANUAL
W266	C200HW-SRM21-V1 CS1W-SRM21 CJ1W-SRM21 CQM1-SRM21-V1 SRT1/SRT2	CompoBus/S OPERATION MANUAL
W136	C500-RM001(-P)V1 C120-RM001(-P) C500-RT001/RT002(-P)V1 C500/C120-LK010(-P) C200H-RM001-PV1 C200H-RT001/002-P B500-I/O	C series Rack PCs Optical Remote I/O SYSTEM MANUAL
W308	C200HW-ZW3DV2/ZW3PC2 3G8F5-CLK11/21 3G8F6-CLK21	Controller Link Support Software OPERATION MANUAL

Man.No.	Model	Manual
W120	C500-RM201/RT201 C200H-RM201/RT201/202 G71-IC16/OD16 G72C-ID16/OD16 S32-RS1	C series Rack PCs Wired Remote I/O SYSTEM MANUAL
W379	CVM1-DRM21-V1 C200HW-DRM21-V1	DeviceNet Master Units OPERATION MANUAL
W347	C200HW-DRT21 CQM1-DRT21 DRT1	DeviceNet Slaves OPERATION MANUAL
W135	C200H-LK401 C500-LK009-V1	C Series PC Link SYSTEM MANUAL

Support Software

Man.No.	Model	Manual
W463	CXONE-AL□□C-V4 CXONE-AL□□D-V4	CX-One FA Integrated Tool Package SETUP MANUAL
W446		CX-Programmer OPERATION MANUAL
W447		CX-Programmer OPERATION MANUAL : Function Blocks/Structured Text
W464		CX-Integrator OPERATION MANUAL
W344		CX-Protocol OPERATION MANUAL

Read and Understand this Document

Please read and understand this document before using the product. Please consult your OMRON representative if you have any questions or comments.

Warranty and Limitations of Liability

WARRANTY

OMRON's exclusive warranty is that the products are free from defects in materials and workmanship for a period of one year (or other period if specified) from date of sale by OMRON.

OMRON MAKES NO WARRANTY OR REPRESENTATION, EXPRESS OR IMPLIED, REGARDING NON-INFRINGEMENT, MERCHANTABILITY, OR FITNESS FOR PARTICULAR PURPOSE OF THE PRODUCTS. ANY BUYER OR USER ACKNOWLEDGES THAT THE BUYER OR USER ALONE HAS DETERMINED THAT THE PRODUCTS WILL SUITABLY MEET THE REQUIREMENTS OF THEIR INTENDED USE. OMRON DISCLAIMS ALL OTHER WARRANTIES, EXPRESS OR IMPLIED.

LIMITATIONS OF LIABILITY

OMRON SHALL NOT BE RESPONSIBLE FOR SPECIAL, INDIRECT, OR CONSEQUENTIAL DAMAGES, LOSS OF PROFITS OR COMMERCIAL LOSS IN ANY WAY CONNECTED WITH THE PRODUCTS, WHETHER SUCH CLAIM IS BASED ON CONTRACT, WARRANTY, NEGLIGENCE, OR STRICT LIABILITY.

In no event shall the responsibility of OMRON for any act exceed the individual price of the product on which liability is asserted.

IN NO EVENT SHALL OMRON BE RESPONSIBLE FOR WARRANTY, REPAIR, OR OTHER CLAIMS REGARDING THE PRODUCTS UNLESS OMRON'S ANALYSIS CONFIRMS THAT THE PRODUCTS WERE PROPERLY HANDLED, STORED, INSTALLED, AND MAINTAINED AND NOT SUBJECT TO CONTAMINATION, ABUSE, MISUSE, OR INAPPROPRIATE MODIFICATION OR REPAIR.

Disclaimers

CHANGE IN SPECIFICATIONS

Product specifications and accessories may be changed at any time based on improvements and other reasons.

It is our practice to change model numbers when published ratings or features are changed, or when significant construction changes are made. However, some specifications of the products may be changed without any notice. When in doubt, special model numbers may be assigned to fix or establish key specifications for your application on your request. Please consult with your OMRON representative at any time to confirm actual specifications of purchased products.

DIMENSIONS AND WEIGHTS

Dimensions and weights are nominal and are not to be used for manufacturing purposes, even when tolerances are shown.

PERFORMANCE DATA

Performance data given in this manual is provided as a guide for the user in determining suitability and does not constitute a warranty. It may represent the result of OMRON's test conditions, and the users must correlate it to actual application requirements. Actual performance is subject to the OMRON Warranty and Limitations of Liability.

ERRORS AND OMISSIONS

The information in this manual has been carefully checked and is believed to be accurate; however, no responsibility is assumed for clerical, typographical, or proofreading errors, or omissions.

Application Considerations

SUITABILITY FOR USE

OMRON shall not be responsible for conformity with any standards, codes, or regulations that apply to the combination of products in the customer's application or use of the products.

At the customer's request, OMRON will provide applicable third party certification documents identifying ratings and limitations of use that apply to the products. This information by itself is not sufficient for a complete determination of the suitability of the products in combination with the end product, machine, system, or other application or use.

The following are some examples of applications for which particular attention must be given. This is not intended to be an exhaustive list of all possible uses of the products, nor is it intended to imply that the uses listed may be suitable for the products:

- Outdoor use, uses involving potential chemical contamination or electrical interference, or conditions or uses not described in this manual.
- Nuclear energy control systems, combustion systems, railroad systems, aviation systems, medical equipment, amusement machines, vehicles, safety equipment, and installations subject to separate industry or government regulations.
- Systems, machines, and equipment that could present a risk to life or property.

Please know and observe all prohibitions of use applicable to the products.

NEVER USE THE PRODUCTS FOR AN APPLICATION INVOLVING SERIOUS RISK TO LIFE OR PROPERTY WITHOUT ENSURING THAT THE SYSTEM AS A WHOLE HAS BEEN DESIGNED TO ADDRESS THE RISKS, AND THAT THE OMRON PRODUCTS ARE PROPERLY RATED AND INSTALLED FOR THE INTENDED USE WITHIN THE OVERALL EQUIPMENT OR SYSTEM.

PROGRAMMABLE PRODUCTS

OMRON shall not be responsible for the user's programming of a programmable product, or any consequence thereof.

C200H Replacement Guide

From C200H to CS1

Table of Contents

1. Work flow.....	2
2. Selecting the model.....	3
3. Reading data from C200H	7
4. Converting the program for CS1	9
5. Writing data to CS1	11
6. Appendix	13
Appendix A. Instructions converted by Change Model on CX-Programmer	13
Appendix B. Change of unit area allocation.....	14
Appendix C. Change in PLC Settings	14
Appendix D. Change of execution timing etc.....	14
Appendix E. Table of Input/Output Units.....	15

This replacement guide describes the procedure to rebuild the system which uses the C200H-series PLC by introducing the CS1-series PLC instead. The CS-series has functions which can replace the functions and operation of C200H-series PLC. Take the below work flow to replace your system. Also, refer to the reference pages for details.

1. Work flow

1) Preliminary Steps: Take the following steps before starting the replacement work.

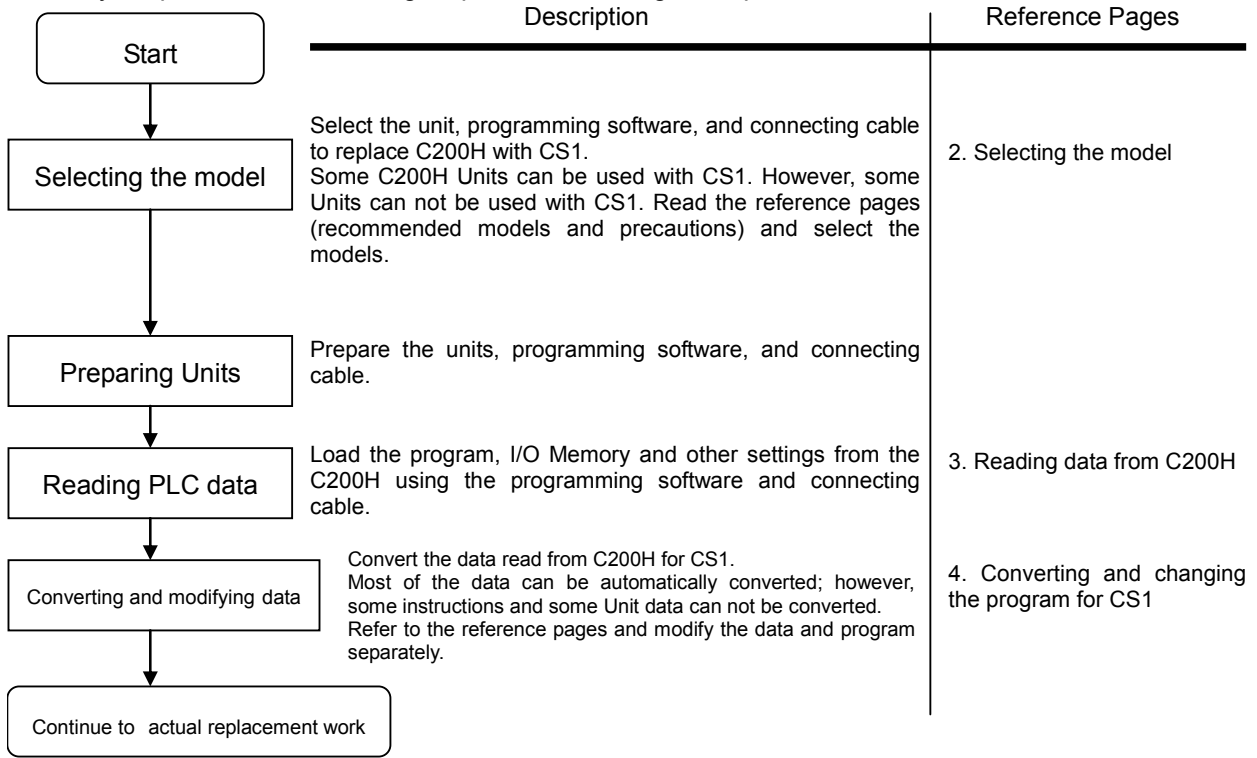

2) Actual replacement work: Take the steps below to replace the C200H to CS1.

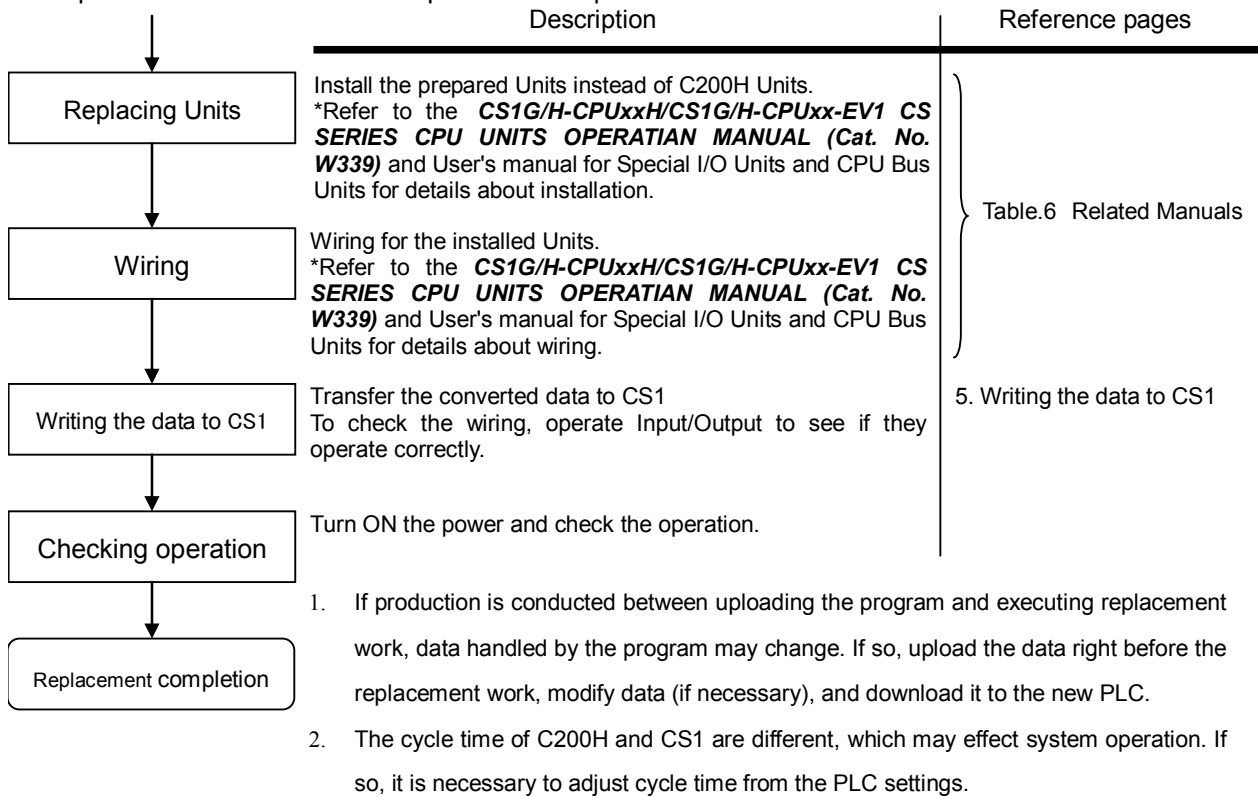

2. Selecting the model

Outline of the system configuration

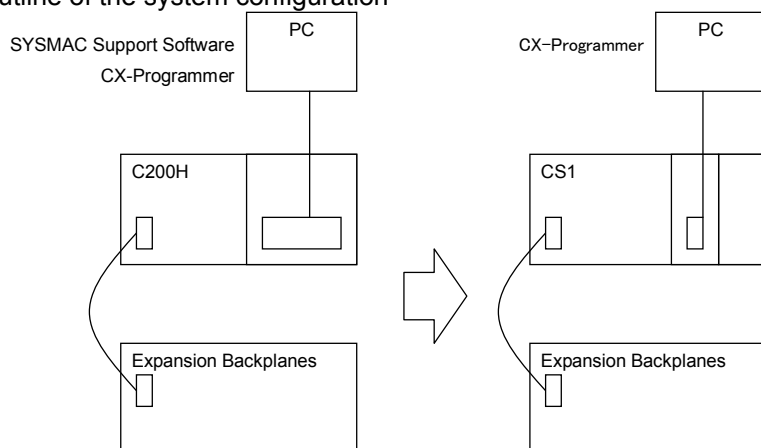

The table below lists the models of C200H-series and each corresponding models of CS1-series. Select the CS1-series model which is compatible with the C200H-series model. Or, select the CS1-series model with similar specification to the C200H-series Unit.

Refer to the *CS1G/H-CPU□□H/CS1G/H-CPU□□-EV1 CS SERIES CPU UNITS OPERATIION MANUAL* (Cat. No. W339) for details of the Units.

< CPU Units and Power Supply Units >

Unit name	C200H-series	CS1-series	Description
CPU Units	C200H-CPU01 C200H-CPU02 C200H-CPU03 C200H-CPU21 C200H-CPU22 C200H-CPU23	CS1G-CPU42H	UM 10K steps
CPU Unit-mounting Host Link Units	C120-LK201(RS232C) C120-LK202(RS422)*1	Built-in Host Link port	(*) To replace C120-LK202, use a NT-AL001 to convert RS232C into RS422.
Power Supply Units	(For C200H-CPU01/02/21/22)	C200HW-PA204 (AC Power Supply Unit)	To use RUN output, prepare Output Unit separately.
		C200HW-PA204S (AC Power Supply Unit)	With 24 VDC service power supply To use RUN output, prepare Output Unit separately.
		C200HW-PA204C (AC Power Supply Unit)	With maintenance forecast monitor.
		C200HW-PA204R (AC Power Supply Unit)	With RUN output.
		C200HW-PA209R (AC Power Supply Unit)	With RUN output.
	(For C200H-CPCPU03/23)	C200HW-PD024(DC Power Supply Unit)	To use RUN output, prepare Output Unit separately.
	C200HW-PD025(DC Power Supply Unit)	To use RUN output, prepare Output Unit separately.	
CPU Backplanes	C200H-BC031(-□□) C200H-BC051(-□□) C200H-BC081(-□□) C200H-BC101(-□□)	CS1W-BC033/BC032 CS1W-BC053/BC052 CS1W-BC083/BC082 CS1W-BC103/BC102	Respectively for 3, 5, 8, and 10 slots. The installation hole position is the same.

Memory Cassette

Unit name	C200H-series	CS1-series	Description
Memory Unit	Memory Unit (RAM type) C200H-MR431 (Battery type) C200H-MR432 (Capacitor type) C200H-MR831 (Battery type) C200H-MR832 (Capacitor type) C200H-MR433 (Battery type, with clock function) C200H-MR833 (Battery type, with clock function)	None	The CS Series CPU Units have a nonvolatile memory for user program in it. The memory unit is unnecessary. They also have the clock function.
	EEP ROM Unit C200H-ME431 C200H-ME432 (with clock function) C200H-ME831 C200H-ME832 (with clock function)	None	The CS Series CPU Units have a nonvolatile memory for user program in it. The memory unit is unnecessary. They also have the clock function. The program file and the parameters are stored in the memory card. It is possible to execute operation by reading them at power ON. (Automatic Transfers at Power ON)
	C200H-MP831	None	The CS Series CPU Units have a nonvolatile memory for user program in it. The memory unit is unnecessary. They also have the clock function. The program file and the parameters are stored in the memory card. It is possible to execute operation by reading them at power ON. (Automatic Transfers at Power ON)

<I/O Expansion System>

Unit name	C200H-series	CS1-series	Description
Power Supply Units	C200H-PS221	C200HW-PA204 (AC Power Supply Unit)	
		C200HW-PA204C (AC Power Supply Unit)	With maintenance forecast monitor.
		C200HW-PA204S (AC Power Supply Unit)	With 24 VDC power supply.
		C200HW-PA204R (AC Power Supply Unit)	The RUN output does not operate.
		C200HW-PA209R (AC Power Supply Unit)	The RUN output does not operate.
	C200H-PS211	C200HW-PD024 (DC Power Supply Unit)	
		C200HW-PD025 (DC Power Supply Unit)	
Backplanes (Expansion Backplanes)	C200H-BC031(-□□) C200H-BC051(-□□) C200H-BC081(-□□) C200H-BC101(-□□)	CS1W-BI033/BI032 CS1W-BI053/BI052 CS1W-BI083/BI082 CS1W-BI103/BI102	Respectively for 3, 5, 8, and 10 slots The installation hole position is the same.
Connecting Cables for Expansion Backplanes	C200H-CN□□1	CS1W-CN□□3	This cable connects a CS1 CPU Backplane and a CS1 Expansion Backplanes.
		CS1W-CN□□1	This cable connects a CS1 CPU Backplane and an Expansion I/O Backplanes (C200HW-BI□□1-V2).

<I/O Units, CPU Bus Units>

Unit name	C200H-series	CS1-series	Description
Basic I/O Units	C200H-I□□□ C200H-O□□□ C200H-M□□□	C200H-I□□□ C200H-O□□□ C200H-M□□□ Or, CS1W-I□□□ CS1W-O□□□ CS1W-M□□□	C200H-series Basic I/O Units can be used with CS1-series CPU Units. Refer to Appendix E. Table of Input/Output Units for CS1 Basic Input/Output Units corresponding to C200H Basic Input/Output Units. We recommend replacing the C200H-series Basic Units with CS1-series Basic I/O Units for maintenance purpose.
Special I/O Unit	C200H-□□□□	C200H-□□□□ Or, CS1W-□□□□	C200H-series Special I/O Units can be used with CS1-series CPU Units. However, there are some remarks to be followed. To improve the system performance and to facilitate maintenance, we recommend you to use the CS-series Units instead.
Communication Units	[SYSMAC LINK] Coaxial cable type: C200H-SLK21-V1 C200HS-SLK22 C200HW-SLK23/24 Optical Fiber Cable type: C200H-SLK11 C200HS-SLK12 C200HW-SLK13/14	[SYSMAC LINK] Coaxial cable type: CS1W-SLK21 Optical cable type: CS1W-SLK11 Or, [Controller Link] Wire type: CS1W-CLK23 Optical Fiber Cable type: CS1W-CLK13/53	C200HW-SLK□□ can not be used with CS1-series CPU Unit. Refer to the SYSMAC CS1W-SLK11/21 SYSMAC LINK Units OPERATION MANUAL (Cat. No. W367) for details about SYSMAC LINK. We recommend you to use the Controller Link instead. Refer to the Controller Link Units (Wire type) Operation Manual (Cat. No. W309) and Controller Link Units (H-PCF Optical Fiber Cable ring connection) Operation Manual (Cat. No. W370) for details.
	[SYSNET] C200H-SNT31 C200HS-SNT32	[SYSNET] None [Controller Link] Wire type:CS1W-CLK23 Optical Fiber Cable type: CS1W-CLK13/53	SYSNET can not be used with CS1-series CPU Unit. We recommend you to renew the system with Controller Link instead. Refer to the Controller Link Units (Wire type) Operation Manual (Cat. No. W309) and Controller Link Units (H-PCF Optical Fiber Cable ring connection) Operation Manual (Cat. No. W370) for details.
	[Host Link]	[Serial Communication]	C200H Host Link Unit can not be used with CS1-series CPU Unit. Refer to the SYSMAC CS/CJ Series Serial Communications Boards/Units OPERATION MANUAL (Cat. No. W336) for details.
	C200H-LK101-PV1	None CS1W-SCU21-V1 (+ optical link module)	The CS-series does not have the Optical-type Serial Communications Board/Unit. Use the wire-type instead, or use an external optical link module.
	C200H-LK201-V1	CS1W-SCU21-V1 CS1W-SCB21-V1 CS1W-SCB41-V1 Host Link port built-in the CPU Unit	Use one of the left CS1-series Unit/Board.
	C200H-LK202-V1	CS1W-SCU31-V1 CS1W-SCB41-V1	Use one of the left CS1-series Unit/Board.
	[PC Link] C200H-LK401	[PC Link] C200H-LK401 [Controller Link] Wire type:CS1W-CLK23 Optical Fiber Cable type: CS1W-CLK13/53	PC Link Unit can be used with CS1-series CPU Unit. However, link area allocation, etc. must be modified. We recommend you to use the Controller Link instead. Refer to the Controller Link Units (Wire type) Operation Manual (Cat. No. W309) and Controller Link Units (H-PCF Optical Fiber Cable ring connection) Operation Manual (Cat. No. W370) for details.

Unit name	C200H-series	CS1-series	Description
Communication Units	[SYSBUS] Wire type:C200H-RM201 Optical Fiber Cable type: C200H-RM001-PV1	[SYSBUS] Wire type: C200H-RM201 Optical Fiber Cable type: C200H-RM001-PV1 [CompoNet] CS1W-CRM21 [DeviceNet] CS1W-DRM21-V1 [CompoBus/S] CS1W-SRM21	SYSBUS Unit can be used with CS1-series CPU Unit. However, relay area allocation, etc. must be modified. To improve the system performance and to facilitate maintenance, we recommend you to use left networks instead. Refer to the CS/CJ series CompoNet Master Units Operation Manual (Cat. No. W456) and CompoNet Slave Units and Repeater Unit OPERATION MANUAL (Cat. No. W457) for details of CompoNet. Refer to the SYSMAC CS/CJ series CS-series: CS1W-DRM21(-V1)CJ Series: CJ1W-DRM21 DeviceNet Units OPERATION MANUAL (Cat. No. W380) for details about DeviceNet. Refer to the C200HW-SRM21-V1 CS1W-SRM21, CJ1W-SRM21 CQM1-SRM21-V1 SRT1 Series SRT2 Series CompoBus/S OPERATION MANUAL (Cat. No. W226) for details about CompoBus/S.

<Support software and peripheral devices>

Name	C200H-series	CS1-series	Description
Support software	SYSMAC Support Software CX-Programmer	CX-One CXONE-AL□□C-V□/ AL□□D-V□ (CX-Programmer Ver.3.0 or higher)	SYSMAC Support Software can not be used with CS1-series CPU Unit.
Peripheral Interface Unit, connecting cable	C200H-IP007	CS1W-CN226/626	To load the program onto CX-Programmer from C200H, C200H-IP007 and cable (CQM1-CIF02) are required.
Programming Console	C120-PRO15 C120-PRO25	C200H-PRO27(+CS1W-CN□□4) CQM1-PRO01(+CS1W-CN114)	CS1W-CN□□4 is a Programming Console Connecting Cable. A cassette interface can not be used.
PROM Writer	C500-PRW06	None	EPROM can not be used with CS1-series. Save the data using a PC (CX-Programmer).
Floppy disk interface	C500-FD103	None	Save the data using a PC (CX-Programmer).
Printer interface unit	C500-PRT01 C2000-MP103-V□	None	Print the data using a PC (CX-Programmer).

Other remarks

- (1) The CPU Unit and Power Supply Unit are separated with CS1-series, though they are combined with C200H-series. The two series use different Backplanes. However, the installation hole position is the same.
- (2) The DIN track (PFP-50N/100N/100N2) and mounting bracket (C200H-DIN01) can be used for the CS1 backplane, too.
- (3) The backplane of the CS1-series has an installation structure to be insulated from the control board etc., Insulation Plates for CPU Backplanes (C200HW-ATT31/51/81/A1) is unnecessary.
- (4) I/O Unit bracket can not be used with CS1-series. The Units of CS1-series can be secured with screws. They do not require brackets.

3. Reading data from C200H

Load the ladder program, and Data Memory from the C200H using the CX-Programmer.

Required items	Support software (PC)	CX-One (CXONE-AL□□C-V□, CXONE-AL□□D-V□) Or, CX-Programmer (WS02-CXPC□-V□)
	Peripheral Interface Unit and connecting cable	C200H-IP007 and CQM1-CIF02 Or, C120-LK201-V1 and XW2Z-200P-V

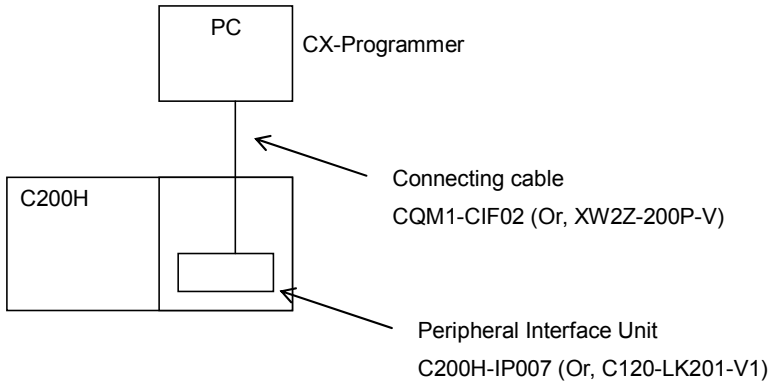

(1) Attach the Peripheral Interface Unit onto the C200H and connect it with a PC.

(2) Start up the CX-Programmer.

(On the Start menu, select **All Program - OMRON - CX-One - CX-Programmer - CX-Programmer.**)

(3) Select C200H for the Device Type. (Select **File - New** to display below dialog).

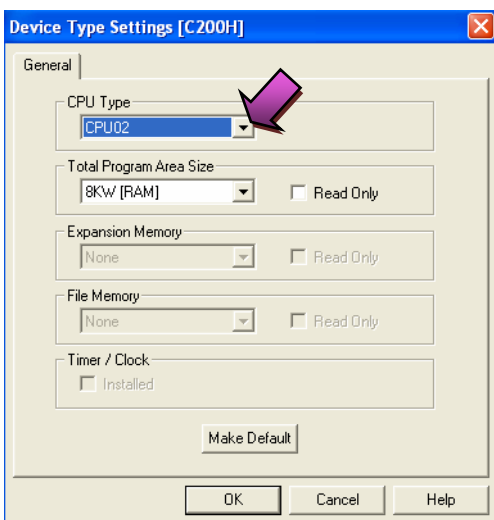
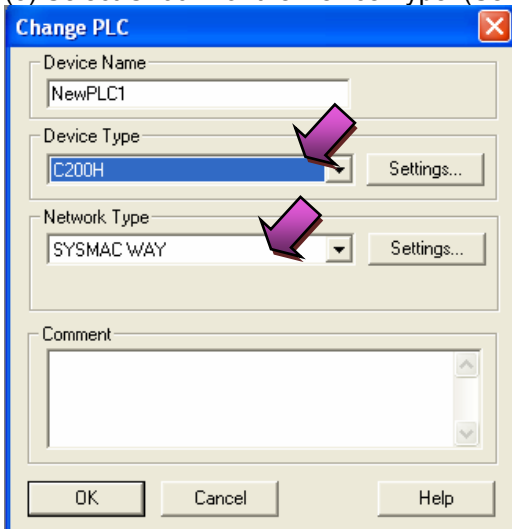

- (4) Connect the PLC and the CX-Programmer online. (Select **PLC - Work Online**).
- (5) Transfer the ladder program and I/O table. (Select **PLC - Transfer - From PLC**.)

Press the **OK** button to start transfer.

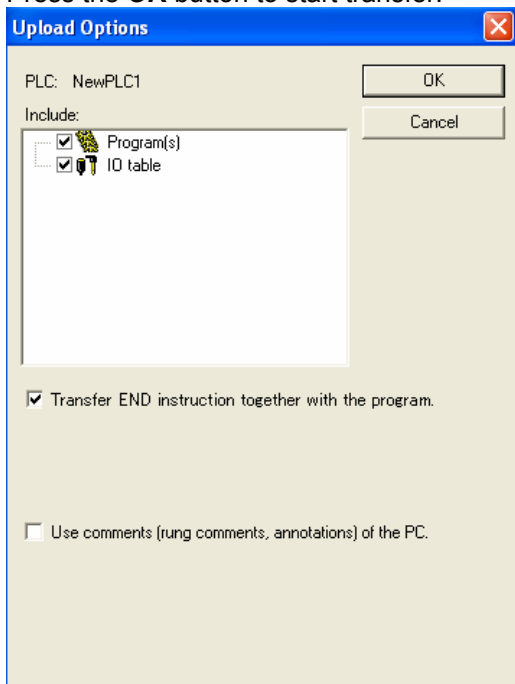

- (6) Transfer the PLC memory data (Data Memory). (Select **PLC** on the menu bar and then click **Edit - Memory**.)

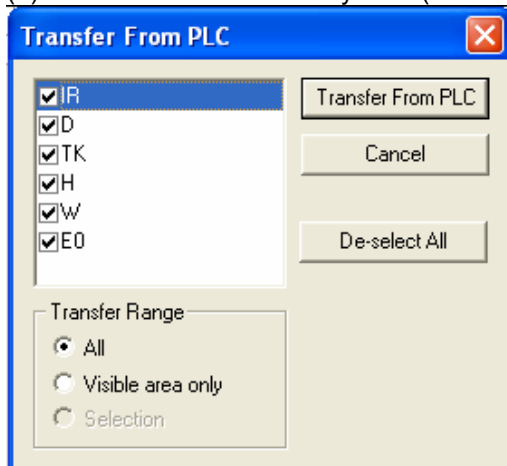

Scroll and check all the areas. Press the **Transfer from PLC** button to start transfer.

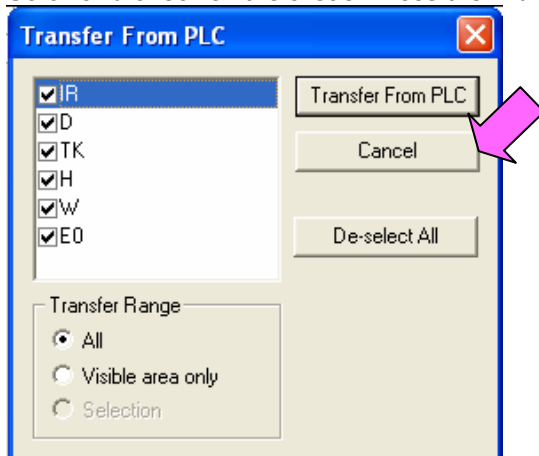

- (7) Make the CX-Programmer offline. (Select **PLC - Work Online**.)
- (8) Save the program by specifying the project name. (Select **File - Save As**).

4. Converting the program for CS1

On the CX-Programmer, convert the program for CS1.

(1) Start the CX-Programmer and open the program file for C200H. (Select **File - Open**.)

(2) Change the Device Type from C200H to CS1. (Select **PLC - Change Model** to display below dialog.)

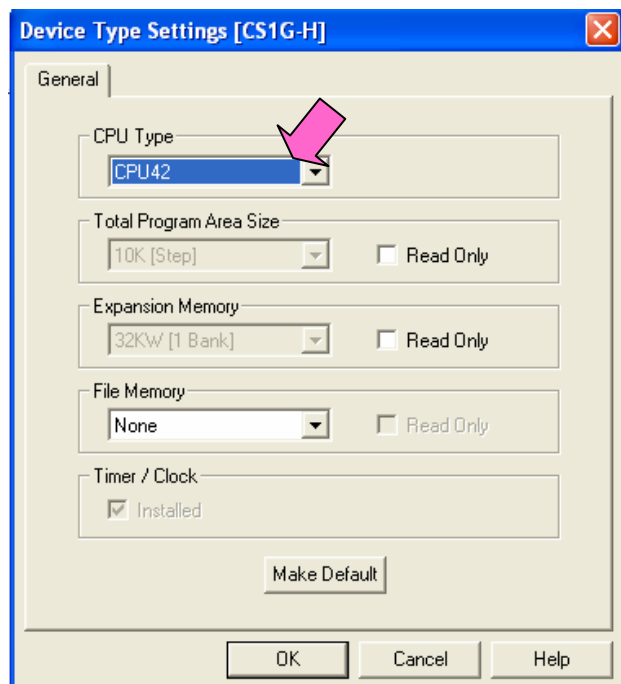
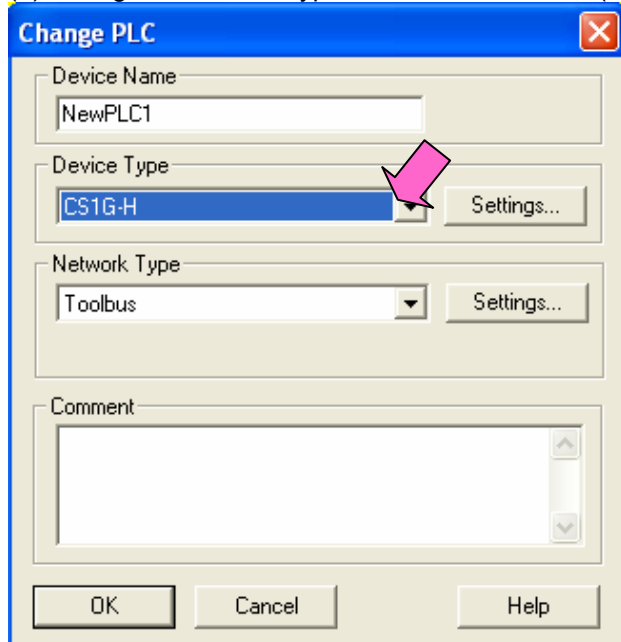

(3) The instructions are automatically converted. The Output Window shows the conversion results. Double-click an error shown on the Output Window to jump to the corresponding section of the ladder program.

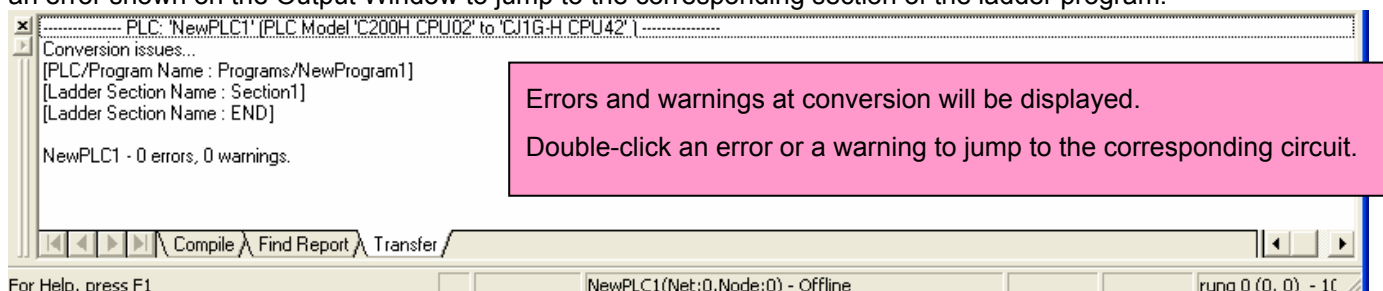

Some instructions cannot be converted. Modify the ladder program referring to *Appendix A. Instructions converted*

by *Change Model on CX-Programmer*.

You can check the program by selecting **Program - Compile** (Program Check). The Output Window shows the checking results.

(4) The PLC memory data cannot be maintained when PLC model is changed. Open the PLC Memory window for both C200H and CS-series PLCs and copy and paste the necessary memory data after conversion.

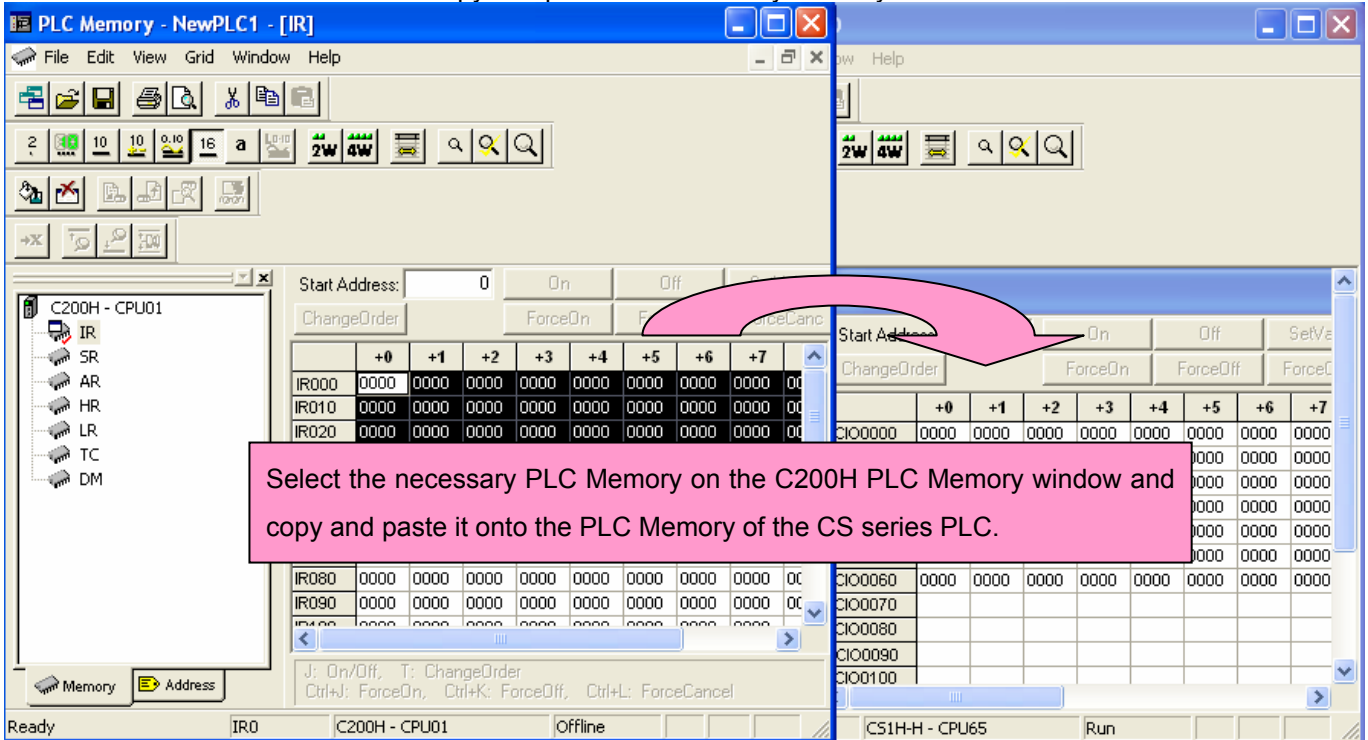

(5) The I/O allocation of C200H-series is partly different from that CS1-series. Refer to *Appendix B. Change of data area allocation* and modify the ladder program.

(6) The PLC settings of C200H-series are partly different from that of CS1-series. Refer to *Appendix C. Change in PLC settings* and change the PLC settings.

(7) Select **Program - Compile** to check the program. If an error is detected, correct it.

(8) Save the program by specifying the project name. (Select **File - Save As**.)

5. Writing data to CS1

Transfer the converted and modified program, PLC settings and Data Memory to the CS1.

Required items	Support software (PC)	CX-One CXONE-AL□□C-V□□/ AL□□D-V□ (CX-Programmer)
	Connecting cable	CS1W-CN226/626

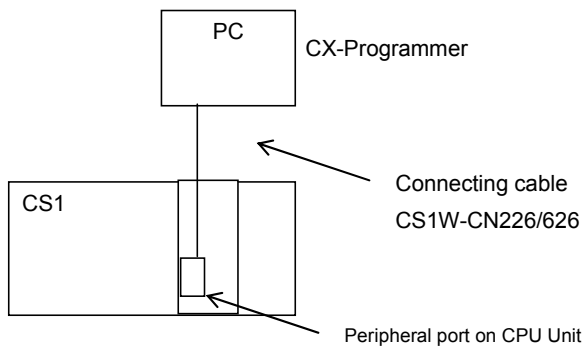

- (1) Connect the CS1 and the PC.
- (2) Start the CX-Programmer and open the converted program file.
- (3) Connect the CS1 and the CX-Programmer online.
- (4) Transfer the ladder program and PLC settings to the CS1. (Select **PLC - Transfer - To PLC.**)

Click the check boxes for Program and PLC Settings. Press the **OK** button to start transfer.

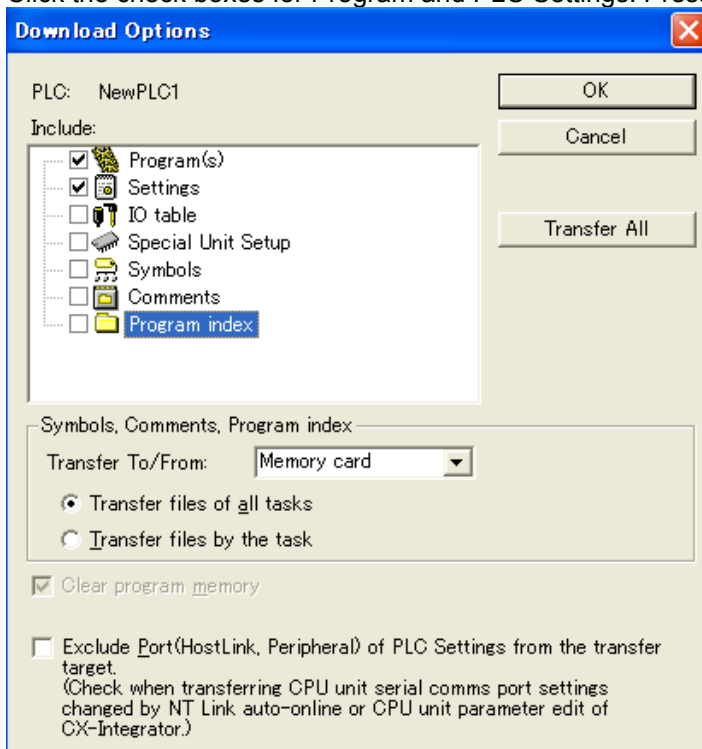

(5) Select **PLC** on the menu bar and then click **Edit - Memory** to display below dialog. Transfer the PLC memory (Data Memory: D and Holding Relay: HR) after selecting the transfer data. Click the **Transfer to PLC** button.

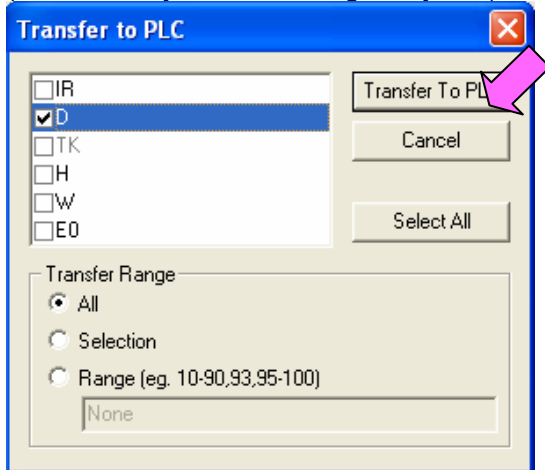

(6) Make the CX-Programmer offline.

6. Appendix

Appendix A. Instructions converted by Change Model on CX-Programmer

(1) The data type of operand is changed from BCD data to BIN data for some instructions.

(2) The number of operand is changed for some instructions.

(3) Interrupt control instructions must be changed. (Use MSKS, MSKR, CLI, DI, and EI).

Refer to the list below for detail. The table lists the instructions which are automatically converted producing some difference between instructions before and after conversion. The other instructions are automatically converted.

Instruction for C200H	Instruction for CS1	Operand	Number of Operand
JMP(04)	JMP(4) JMP0(515)	or	#0: 1 -> 0 = #0: Same
JME(05)	JME(5) JME0(516)	or	#0: 1 -> 0 = #0: Same
WSFT(16)	Same as C200H	#0 is added to the Operand1. WSFT D1 D2 -> WSFT #0 D1 D2	Changed from 2 to 3
FUN17	ASFT(017)	Same as C200H	Same
XFER(70)	XFERC(565)	Same as C200H	Same
MOVB(82)	MOVBC(568)	Same as C200H	Same
DIST(80)	DISTC(566)	Same as C200H	Same
COLL(81)	COLLC(567)	Same as C200H	Same
FUN60	CMPL(060)	Same as C200H	Same
FUN19	MCMP(019)	Same as C200H	Same
FUN63	LINE(063)	Changed from BCD data to BIN data.	Same
FUN64	COLM(064)	Changed from BCD data to BIN data.	Same
FUN65	SEC(065)	Same as C200H	Same
FUN66	HMS(066)	Same as C200H	Same
INC(38)	++B(594)	Same as C200H	Same
DEC(39)	--B(596)	Same as C200H	Same
ADD(30)	+B(404)	Same as C200H	Same
ADDL(54)	+BL(405)	Same as C200H	Same
SUB(31)	-B(414)	Same as C200H	Same
SUBL(55)	-BL(415)	Same as C200H	Same
MUL(32)	*B(424)	Same as C200H	Same
MULL(56)	*BL(425)	Same as C200H	Same
DIV(33)	/B(434)	Same as C200H	Same
DIVL(57)	/BL(435)	Same as C200H	Same
ADB(50)	+(400)	Same as C200H	Same
SBB(51)	-(410)	Same as C200H	Same
MLB(52)	*(420)	Same as C200H	Same
DVB(53)	/(430)	Same as C200H	Same
FUN69	APR(069)	Same as C200H	Same
FUN89	Not supported	Combine and use below instructions: MSKS(690), CLI(691), MSKR(692), DI(693), EI(694)	
STEP(08)	Same as C200H	The CIO, Holding, Work, Auxiliary, DM, and EM Area are all converted into the WR relay.	Same
SNXT(09)	Same as C200H Use a differentiated execution condition for the SNXT instruction.	Same as C200H	Same
FAL(06)	Same as C200H	#0 is added to Operand 2. FAL N -> FAL N #0	Changed from 1 to 2.
FALS(07)	Same as C200H	#0 is added to Operand 2. FALS N -> FALS N #0	Changed from 1 to 2.
MSG(46)	MSG(46)	#0 is added to Operand 1. MSG S -> MSG #0 S Number of characters (words) to be registered from first message word (S) is changed from 16 characters (8 words) to 32 characters (16 words).	Changed from 1 to 2.
FUN47	Not supported	Use MSG(46), instead.	—
FUN67	BCNTC(621)	Same as C200H	Same
WDT(94)	WDT(094)	Control data configuration is different.	Same
FUN61	IORF(097)	On CS1, Unit No, of C200H Group-2 High-density I/O Units is disabled. Specify the allocation by using IORF in the same way as Basic I/O Units.	
FUN18	Enter the settings from PLC settings.		
FUN48	Not supported	—	—
FUN49	Enter the settings from PLC settings.		
FUN90	SEND(090)	Control data configuration is different.	Same
FUN98	RECV(098)	Control data configuration is different.	Same

Appendix B. Change of unit area allocation

This section describes the difference of unit area allocation in C200H and CS1-series. Refer to related manuals for details.

Item	C200H-series	CS1-series	Description
I/O allocation Basic I/O	"Free location and fixed channel"	"Free location and free channel" Change the channel and bit address used in the program.	For CS1-series, it is necessary to register I/O table.
I/O allocation Special I/O	IR 100 to 199 (10words allocated for each Unit No.) DM1000 to 1999 (100words allocated for each Unit No.)	CIO 2000 to 2199 (10words allocated for each Unit No.) DM20000 to 21999 (100words allocated for each Unit No.) Change the channel and bit address used in the program.	Refer to CS1G/H-CPU**H /CS1G/H-CPU**-EV1 CS SERIES CPU UNITS OPERATIION MANUAL (Cat. No. W339) for details on I/O allocation.
I/O allocation (Group-2 High-density I/O Units)	IR 30 to 49 (2 or 4 words allocated for each Unit)	The allocation is decided in the same way as a Basic I/O Units depending on the installed position (rack and slot). Change the channel and bit address used in the program.	
Auxiliary Relay Area	SR 236 to 255	(1) AR Area and Bit. Change the channel and bit address used in the program. (2) Condition flags and clock pulse Change the operation flags in the program to the condition flags. Use the global symbols such as P_0.1ms and P_1ms instead of the clock pulse.	Operation flags and condition flags of CS1 can be specified by label.
Link Relay Area (PC Link)	LR00 to LR63	CIO 1000 to 1063 Change the channel and bit address used in the program.	
SYSBUS Remote I/O	50 to 99	CIO 3000 to 3049 Change the channel and bit address used in the program.	
Abnormal history storage area	DM 969 to 999	AR 100 to A199	Change the program if the Error History Area is read in the program.

Appendix C. Change in PLC Settings

Item	C200H-series	CS1-series	Description
Mode at Power ON	Setting switch on the memory unit	Select the "Mode" at power ON from PLC settings.	
Constant Cycle Time Function	Constant Cycle Time (FUN18)	Enter the value in the "Constant Cycle Time" from PLC settings.	Use DI (DISABLE INTERRUPTS) instruction and EI (ENABLE INTERRUPTS) instruction when simultaneity of data is required between the Cycle Tasks and Interrupt Tasks.

Appendix D. Change of execution timing etc.

Item	C200H-series	CS1-series	Description
Interrupt execution method and execution timing	Write the interrupt program in subroutine.	Write the interrupt program in interrupt task.	For CS1, an Interrupt Task is executed even when an instruction is being executed or I/O refreshing.
Cycle Time	-	The cycle time is shortened with CS1. If the system operation is affected by cycle time, check the operation with the converted program.	To obtain the same cycle time as C200H, set the time from the "Constant Cycle Time" in the PLC settings
Read-protection function	FUN49	Use password protection function of CX-Programmer.	

- Input Unit

- (1) If different terminal block or connector is used, you have to change the wiring.
- (2) If the input circuit specification is not the same, check if there is no problem in operation.
- (3) If the number of circuit is different (increased), wire and connect the terminals and each common terminals.
- (4) If the current consumption is different, check if enough power supply capacity is provided.
- (5) C200H-series Units can be used with CS1-series CPU Units.
- (6) Refer to related manuals for details, even if functions of C200H-series are supported by CS1-series Units, since a part of specifications may differ.

DC Input Unit

C200H-series Unit	Corresponding CS-series Unit	Description	Difference
C200H-ID211 12 to 24 VDC, 10mA, Terminal block, 8 inputs	CS1W-ID211 24VDC, 7mA, Terminal block, 16 inputs	DC Input Unit with terminal block for 8 inputs Replace this unit with a DC Input Unit with 16 inputs.	1) Terminal block 2) Input points (8 -> 16 points) 3) Input circuit specification Input voltage range (12 to 24 VDC -> 24VDC) Input impedance (2kΩ-> 3.3kΩ) ON Voltage(10.2VDC->14.4VDC) OFF Voltage(3VDC->5VDC) 4) Internal current consumption(5VDC: 10mA->100mA)
C200H-ID212 24 VDC, 7mA, Terminal block, 16 inputs	CS1W-ID211 24VDC, 7mA, Terminal block, 16 inputs	DC Input Unit with terminal block for 16 inputs.	1) Terminal block 2) Number of circuit (16 points/common x1 circuit -> 8 points/common x2 circuits) 3) Input circuit specification Input impedance(3kΩ->3.3kΩ) 4) Internal current consumption (5VDC:10mA->100mA)
C200H-ID215 24 VDC, 4.1mA, Connector 32 inputs (Special I/O G)	CS1W-ID231 24VDC, 6mA, Connector, 32 inputs	DC Input Unit with connector for 32 inputs.	1) Connector 2) (8 points/common x4 circuits->16 points/common x2 circuits) 3) Input circuit specification Input impedance(5.6kΩ->3.9kΩ) ON Voltage(DC14.4V->DC15.4V) 4) Internal current consumption (5VDC:130mA->150mA)
C200H-ID216 24 VDC, 4.1mA, Connector, 32 inputs (Group-2)	CS1W-ID231 24VDC, 6mA, Connector, 32 inputs	DC Input Unit with connector for 32 inputs.	1) Number of circuit(32 points/common x1 circuit ->16 points/common x2 circuits) 2) Input circuit specification Input impedance(5.6kΩ->3.9kΩ) ON Voltage(DC14.4V->DC15.4V) 3) Internal current consumption (5VDC:100mA->150mA)
C200H-ID218 24 VDC, 6.0mA, Connector, 32 inputs (Group-2)	CS1W-ID231 24VDC, 6mA, Connector, 32 inputs	DC Input Unit with connector for 32 inputs.	1) Number of circuit (32 points/common x1 circuit ->16 points/common x2 circuits) 2) Internal current consumption (5VDC:100mA->150mA)
C200H-ID111 12 VDC, 4.1mA, Connector, 64 inputs (Group-2)	CS1W-ID261 24VDC, 6mA, Connector, 64 inputs	DC Input Unit with connector for 64 inputs.	1) Number of circuit (32 points/common x2 circuit->16 points/common x4 circuits) 2) Input circuit specification Input voltage(12VDC->24VDC) Input impedance (2.7kΩ->3.9kΩ) ON Voltage(8VDC->15.4VDC) OFF Voltage(3VDC->5VDC) 3) Internal current consumption (5VDC:120mA->150mA)
C200H-ID217 24 VDC, 4.1mA, Connector, 64 inputs (Group-2)	CS1W-ID261 24VDC, 6mA, Connector, 64 inputs	DC Input Unit with connector for 64 inputs.	1) Number of circuit (32 points/common x2 circuit ->16 points/common x4 circuits) 2) Input circuit specification Input impedance (5.6kΩ->3.9kΩ) ON Voltage (14.4VDC->15.4VDC) Internal current consumption (5VDC:120mA->150mA)
C200H-ID219 24 VDC, 6.0mA, Connector, 64 inputs (Group-2)	CS1W-ID261 24VDC, 6mA, Connector, 64 inputs	DC Input Unit with connector for 64 inputs.	1) Number of circuit (32 points/common x2 circuit ->16 points/common x4 circuits) 2) Internal current consumption (5VDC:120mA->150mA)

<TTL Input Unit>

C200H-series Unit	Corresponding CS-series Unit	Description	Difference
C200H-ID501 5VDC, 3.5mA, Connector, 32 inputs (Special I/O Unit)	No replacement model	TTL Input Unit with connector for 32 inputs. The CS-series does not have the same type of Unit. Use the C200H-ID501 with CS1, or use 24VDC Input Unit (CS1W-ID231) or TTL Input/Output Unit (CS1W-MD561) instead.	

<AC Input Unit>

C200H-series Unit	Corresponding CS-series Unit	Description	Difference
C200H-IA121 100-120VAC/10mA, and Terminal block, 8 inputs	CS1W-IA111 100-120VAC/10mA, 100 to 120VDC/1.5mA, Terminal block, 16 inputs	100VAC Input Unit with terminal block for 8 inputs. Replace this unit with a 100VAC Input Unit with 16 inputs.	1) Terminal block 2) Input points (8 -> 16 points) 3) Input circuit specification Input impedance (9.7kΩ/50Hz->10kΩ/50Hz) ON Voltage (60V->65V) 4) Internal current consumption (5VDC:10mA->110mA)
C200H-IA221 200-240VAC/10mA, and Terminal block, 8 inputs	CS1W-IA211 200-240VAC/10mA, Terminal block, 16 inputs	200VAC Input Unit with terminal block for 8 inputs. Replace this unit with a 200VAC Input Unit with 16 inputs.	1) Terminal block 2) Input points (8 -> 16 points) 3) Internal current consumption (5VDC:10mA->110mA)
C200H-IA122/IA122V 100-120VAC/10mA, Terminal block, 16 inputs, IA122V: Complying with EC Directive	CS1W-IA111 100-120VAC/10mA, 100 to 120VDC/1.5mA, Terminal block, 16 inputs	100VAC Input Unit with terminal block for 16 inputs.	1) Terminal block 2) Number of circuit (16 points/common x1 circuit ->8 points/common x2 circuits) 3) Input circuit specification Input impedance (9.7kΩ/50Hz->10kΩ/50Hz) ON Voltage (60VAC->65VAC) Internal current consumption (5VDC:10mA->110mA)
C200H-IA222/IA222V 200-240VAC/10mA, Terminal block, 16 inputs, IA222V: Complying with EC Directive	CS1W-IA211 200-240VAC/10mA, Terminal block, 16 inputs	200VAC Input Unit with terminal block for 16 inputs.	1) Terminal block 2) Number of circuit (16 points/common x1 circuit ->8 points/common x2 circuits) 3) Internal current consumption (5VDC:10mA->110mA)

<AC/DC Input Unit>

C200H-series Unit	Corresponding CS-series Unit	Description	Difference
C200H-IM211 12-24 VAC/VDC, Terminal block, 8 inputs	CS1W-ID211 24 VDC, 7mA, Terminal block, 16 inputs	AC/DC Input Unit with terminal block for 8 inputs. Replace this unit with a DC Input Unit with 16 inputs. *The CS-series does not have the AC/DC Input Unit. If this Unit is used with AC inputs, continue using this Unit or change the wiring for DC inputs	1) Terminal block 2) Input points (8 -> 16 points) 3) Input circuit specification Input voltage range(12 to 24 VAC/VDC->24VDC) Input impedance(2kΩ->3.3kΩ) ON Voltage (10.2VDC->14.4VDC) OFF Voltage (3VDC->5VDC) Internal current consumption (5VDC:10mA->100mA)
C200H-IM212 24 VAC/VDC, Terminal block, 16 inputs	CS1W-ID211 24 VDC, 7mA, Terminal block, 16 inputs	AC/DC Input Unit with terminal block for 16 inputs. Replace this unit with a DC Input Unit with 16 inputs. * The CS-series does not have the AC/DC Input Unit. If this Unit is used with AC inputs, continue using this Unit or change the wiring for DC inputs.	1) Terminal block 2) Number of circuit (16 points/common x1 circuit ->8 points/common x2 circuits) 3) Input circuit specification Input voltage range (24VAC/VDC->24VDC), and input impedance (3kΩ->3.3kΩ) 4) Internal power consumption (5VDC:10mA->100mA)

■ Output Unit

- (1) If different terminal block or connector is used, you have to change the wiring.
- (2) If the number of circuit is different (increased), wire and connect the terminals and each common terminals.
- (3) If the output specification is not same, check if there is no problem in operation.
- (4) The relay lifetime might change depending on the usage, when the used relay is different. Refer to the *Appendix F Restrictions in Using C200H Special I/O Units* in the *CS1G/H-CPU**H/CS1G/H-CPU**-EV1 CS SERIES CPU UNITS OPERATIAN MANUAL* (Cat. No. W339) for details of the Output Units.
- (5) If the current consumption is different, check if enough power supply capacity is provided
- (6) If the voltage and current consumption of external power supply is different, check if enough power supply capacity is provided.
- (7) C200H-series Units can be used with CS1-series CPU Unit.
- (8) Refer to related manuals for details, even if functions of C200H-series are supported by CS1-series Units, since a part of specifications may differ.

<Relay Output Units>

C200H-series Unit	Corresponding CS-series Unit	Description	Difference
C200H-OC223 250VAC/24VDC, 2A, Terminal block, 5 outputs (independent contacts)	CS1W-OC201 250 VAC or 120 VDC, 2 A max., terminal block, 8 outputs (Independent contacts)	Relay Output Units with terminal block for 5 outputs (independent contacts). Replace this unit with a Relay Output Unit with 8 outputs (independent contacts).	1) Terminal block 2) Output points (independent contacts 5 points -> 8 points) 3) Output circuit specification ON/OFF response time(10ms->15ms) Used relay 4) Internal current consumption (5VDC:10mA->100mA, 26VDC:46mA->48mA)
C200H-OC224 250VAC/24VDC, 2A, Terminal block, 8 outputs (independent contacts)	CS1W-OC201 250 VAC or 120 VDC, 2 A max., terminal block, 8 outputs (Independent contacts)	Relay Output Units with terminal block for 8 outputs (independent contacts).	1) Terminal block 2) Output circuit specification ON/OFF response time(10ms->15ms) Used relay 3) Internal current consumption (5VDC:10mA->100mA, 26VDC:75mA->48mA)
C200H-OC224V, OC224N 250VAC/24VDC, 2A, Terminal block, 8 outputs (independent contacts)	CS1W-OC201 250 VAC or 120 VDC, 2 A max. , terminal block, 8 outputs (Independent contacts)	Relay Output Units with terminal block for 8 outputs (independent contacts).	1) Terminal block 2) Output circuit specification Used relay 3) Internal current consumption (5VDC:10mA->100mA, 26VDC:90mA->48mA)
C200H-OC221 250VAC/24VDC, 2A, Terminal block, 8 outputs	CS1W-OC211 250 VAC or 120 VDC, 2 A max., terminal block, 16 outputs	Relay Output Units with terminal block for 8 outputs. Replace this unit with a Relay Output Unit with 16 outputs.	1) Terminal block 2) Output points(8 -> 16 points) 3) Output circuit specification ON/OFF response time(10ms->15ms) Used relay 4) Internal current consumption (DC5V: 10mA->100mA, DC26V:75mA->96mA)
C200H-OC222 250VAC/24VDC, 2A, Terminal block, 12 outputs	CS1W-OC211 250 VAC or 120 VDC, 2 A max., terminal block, 16 outputs	Relay Output Units with terminal block for 12 outputs. Replace this unit with a Relay Output Unit with 16 outputs.	1) Terminal block 2) Output points(12 -> 16 points) 3) Number of circuit(12 points/common x1 circuit -> 8 points/common x2 circuits) 4) Output circuit specification ON/OFF response time(10ms->15ms) Used relay 5) Internal current consumption (5VDC:10mA->100mA, 26VDC:75mA->96mA)
C200H-OC222V, OC222N 250 VAC/24VDC, 2A, Terminal block, 12 outputs	CS1W-OC211 250 VAC or 120 VDC, 2 A max. 16 outputs	Relay Output Units with terminal block for 12 outputs. Replace this unit with a Relay Output Unit with 16 outputs.	1) Terminal block 2) Output points (12 -> 16 points) 3) Number of circuit (12 points/common x1 circuit ->8 points/common x2 circuits) 4) Output circuit specification Used relay 5) Internal current consumption (5VDC:10mA->100mA, 26VDC:90mA->96mA)

<Relay Output Units>

C200H-series Unit	Corresponding CS-series Unit	Description	Difference
C200H-OC225 250VAC/24VDC, 2A, Terminal block, 16 outputs	CS1W-OC211 250VAC/120VDC, 2A, Terminal block, 16 outputs	Relay Output Units with terminal block for 16 outputs.	1) Terminal block 2) Number of circuit (16 points/common x1 circuit ->8 points/common x2 circuits) 3) Output circuit specification ON/OFF response time (10ms->15ms) Used relay 4) Internal current consumption (5VDC: 10mA->100mA, 26VDC: 75mA->96mA)
C200H-OC226, OC226N 250VAC/24VDC, 2A, Terminal block, 16 outputs	CS1W-OC211 250VAC/120VDC, 2A, Terminal block, 16 outputs	Relay Output Units with terminal block for 16 outputs.	1) Terminal block 2) Number of circuit (16 points/common x1 circuit ->8 points/common x2 circuits) 3) Output circuit specification Used relay 4) Internal current consumption (5VDC:10mA->100mA, 26VDC:90mA->96mA)

<Transistor Output Units>

C200H-series Unit	Corresponding CS-series Unit	Description	Difference
C200H-OD411 12-48 VDC, 1A, Sinking, Terminal block, 8 outputs	CS1W-OD211 12-24 VDC, 0.5A, Sinking, Terminal block, 16 outputs	Transistor Output Units with terminal block for 8 outputs. Replace this unit with a Transistor Output Unit with 16 outputs.	1) Terminal block 2) Output points (8 -> 16 points) 3) Output circuit specification Output capacity (1A/point, 3A/Unit -> 0.5A/point, 8A/Unit) Voltage range(12 to 48 VDC-> 12 to 24VDC) Residual voltage(1.4V->1.5V) ON response time(0.2ms->0.5ms) OFF response time(0.3ms->1.0ms) 4) Internal current consumption(5VDC:140mA->170mA)
C200H-OD213 24 VDC, 2.1A, Sinking, Terminal block, 8 outputs	CS1W-OD211 12-24 VDC, 0.5A, Sinking, Terminal block, 16 outputs	Transistor Output Units with terminal block for 8 outputs. Replace this unit with a Transistor Output Unit with 16 outputs.	1) Terminal block 2) Output points (8 -> 16 points) 3) Output circuit specification Output capacity (2.1A/point, 5.2A/Unit -> 0.5A/point, 8A/Unit) Residual voltage(1.4V->1.5V) ON response time(0.2ms->0.5ms) OFF response time(0.3ms->1.0ms) 4) Internal current consumption(5VDC:140mA->170mA)
C200H-OD214 24 VDC, 0.8A, Sourcing, Terminal block, load short circuit protection, 8 outputs	CS1W-OD212 12-24 VDC, 0.5A, Sourcing, Terminal block, load short circuit protection, 16 outputs	Transistor Output Units with terminal block for 8 outputs. Replace this unit with a Transistor Output Unit with 16 outputs.	1) Terminal block 2) Output points (8 -> 16 points) 3) Output circuit specification Output capacity(0.8A/point, 2.4A/Unit -> 0.5A/point, 5A/Unit) ON response time(1ms->0.5ms) 4) Internal current consumption (5VDC:140mA->170mA)
C200H-OD216 5 - 24 VDC, 0.3A, Sourcing, Terminal block, 8 outputs	CS1W-OD212 12-24 VDC, 0.5A, Sourcing, Terminal block, load short circuit protection, 16 outputs	Transistor Output Units with terminal block for 8 outputs. Replace this unit with a Transistor Output Unit with 16 outputs.	1) Terminal block 2) Output points (8 -> 16 points) 3) Output circuit specification Output voltage range(5 to 24 VDC-> 24VDC) 4) Internal current consumption (5VDC:10mA->170mA,26VDC:75mA->0mA) 5) External power supply (Not required -> DC24V/40mA)
C200H-OD211 24 VDC, 0.3A, Sinking, Terminal block, 12 outputs	CS1W-OD211 12-24 VDC, 0.5A, Sinking, Terminal block, 16 outputs	Transistor Output Units with terminal block for 12 outputs. Replace this unit with a Transistor Output Unit with 16 outputs.	1) Terminal block 2) Output points (12 -> 16 points) 3) Number of circuit (12 points/common x1 circuit -> 8 points/common x2 circuits) 4) Output circuit specification Residual voltage(1.4V->1.5V) ON response time(0.2ms->0.5ms) OFF response time(0.3ms->1.0ms) 5) Internal current consumption(5VDC:160mA->170mA)

<Transistor Output Units>

C200H-series Unit	Corresponding CS-series Unit	Description	Difference
C200H-OD217 24 VDC, 0.3A, Sourcing, Terminal block, 12 outputs	CS1W-OD212 12-24 VDC, 0.5A, Sourcing, Terminal block, load short circuit protection, 16 outputs	Transistor Output Units with terminal block for 12 outputs. Replace this unit with a Transistor Output Unit with 16 outputs.	1) Terminal block 2) Output points (12-> 16 points) 3) Number of circuit (12 points/common x1 circuit ->8 points/common x2 circuits) 4) Output circuit specification Output voltage range (5 to 24 VDC -> 24VDC) 5) Internal current consumption (5VDC:10mA->170mA, 26VDC:75mA-> 0mA) 6) External power supply (Not required -> 24VDC:40mA)
C200H-OD212 24 VDC, 0.3A, Sinking, Terminal block, 16 outputs	CS1W-OD211 12-24 VDC, 0.5A, Sinking, Terminal block, 16 outputs	Transistor Output Units with terminal block for 16 outputs.	1) Terminal block 2) Number of circuit (16 points/common x1 circuit ->8 points/common x2 circuits) 3) Output circuit specification Residual voltage (1.4V->1.5V) ON response time(0.2ms->0.5ms) OFF response time(0.3ms->1.0ms)
C200H-OD21A 24 VDC, 1.0A, Sourcing, Terminal block, load short circuit protection, 16 outputs	CS1W-OD212 12-24 VDC, 0.5A, Sourcing, Terminal block, load short circuit protection, 16 outputs	Transistor Output Units with terminal block for 16 outputs.	1) Terminal block 2) Number of circuit (16 points/common x1 circuit ->8 points/common x2 circuits) 3) Output circuit specification Output capacity (1A/point, 4A/Unit -> 0.5A/point, 5A/Unit) Residual voltage (0.8V->1.5V) ON response time (0.1ms->0.5ms) OFF response time (0.3ms->1ms) 4) Internal current consumption (5VDC:160mA-> 170mA) 5) External power supply (24 VDC: 35mA-> 40mA) 6) Alarm output (Supported -> Not supported)
C200H-OD218 4.5 to 26.3 VDC, 0.1A, Sinking, Connector, 32 outputs (Group-2)	CS1W-OD231 12-24 VDC, 0.5A, Sinking, Connector, 32 outputs	Transistor Output Units with connector for 32 outputs.	1) Number of circuit (32 points/common x1 circuit ->16 points/common x2 circuits) 2) Output circuit specification Output voltage range (5 to 24 VDC-> 12 to 24VDC) Residual voltage (0.8V->1.5V) ON response time (0.1ms->0.5ms) OFF response time(0.4ms->1ms) 3) Internal current consumption(DC5V: 180mA->270mA) 4) External power supply (5 to 24 VDC:110mA -> 12 to 24VDC:50mA)
C200H-OD215 4.5 to 26.3 VDC, 0.1A, Sinking, Connector, 32 outputs (Special I/O)	CS1W-OD231 12-24 VDC, 0.5A, Sinking, Connector, 32 outputs	Transistor Output Units with connector for 32 outputs. *The CS-series does not have Unit which supports Dynamic Output. Continue using this C200H Unit or change the wiring for static mode.	1) Connector 2) Output method (Dynamic or Static mode -> Static only) The specification of static is as follows. 3) Number of circuit (8 points/common x 4 circuits ->16 points/common x2 circuits) 4) Output circuit specification Output voltage range(5 to 24 VDC -> 12 to 24VDC) Residual voltage (0.7V->1.5V) ON response time (0.2ms->0.5ms) OFF response time (0.6ms->1ms) 5) Internal current consumption (5VDC:220mA->270mA) 6) External power supply (5 to 24 VDC:90mA -> 12 to 24VDC:50mA)
C200H-OD21B 24 VDC, 0.5A, Sourcing, Connector, load short circuit protection, 32 outputs (Group2)	CS1W-OD232 12 - 24 VDC, 0.5A, Sourcing, Connector, load short circuit protection, 32 outputs	Transistor Output Units with connector for 32 outputs.	1) Number of circuit (32 points/common x1 circuit ->16 points/common x2 circuits) 2) Output circuit specification Output capacity (0.5A/point, 5A/Unit -> 0.5A/point, 2.5A/Common, 5A/Unit) Residual voltage (0.8V->1.5V) ON response time (0.1ms->0.5ms) OFF response time (0.3ms->1ms) 3) Internal current consumption (5VDC:180mA -> 270mA)

<Transistor Output Units>

C200H-series Unit	Corresponding CS-series Unit	Description	Difference
C200H-OD219	CS1W-OD261	Transistor Output Units with connector for 64 outputs..	1) Number of circuit (32 points/common x2 circuit ->16 points/common x4 circuits) 2) Output circuit specification Output voltage range (5 to 24 VDC-> 12 to 24VDC) Residual voltage (0.8V->1.5V) ON response time (0.1ms->0.5ms) OFF response time(0.4ms->1ms) 3) Internal current consumption (5VDC:270mA->390mA)
4.5 to 26.3 VDC, Sinking, 0.1A, Connector, 64 outputs (Group2)	12-24 VDC, 0.3A, Sinking, Connector, 64 outputs		

<TTL Output Unit>

C200H-series Unit	Corresponding CS-series Unit	Description	Difference
C200H-OD501	No replacement model	TTL Output Unit with connector for 32 outputs. The CS-series does not have the same type of Unit. Continue using this Unit or use Transistor Output Unit (CS1W-OD231) or TTL Input/Output Unit (CS1W-MD561) instead.	
5 VDC, 35A, Connector, 32 outputs (Special I/O)			

<Triac Output Unit>

C200H-series Unit	Corresponding CS-series Unit	Description	Difference
C200H-OA223	CS1W-OA201	Triac Output Units with terminal block for 8 outputs.	1) Terminal block 2) Output circuit specification Max. Inrush Current (15A: Pulsewidth 100ms, 30A: Pulsewidth 10ms->10A: Pulsewidth 100ms and 20A: Pulsewidth 10ms) 3) Internal current consumption (5VDC:180mA->230mA)
250VAC, 1.2A, Terminal block, 8 outputs	250VAC, 1.2A, Terminal block, 8 outputs		
C200H-OA221	CS1W-OA201	Triac Output Units with terminal block for 8 outputs.	1) Terminal block 2) Output circuit specification Max. Inrush Current (No regulation ->10A: Pulsewidth 100ms and 20A: Pulsewidth 10ms) Residual voltage (1.2VAC-> 50 to 1200mA: 1.5VAC 10 to 50mA: 5VAC) OFF response time (1/2 of load frequency or less -> 1/2 of load frequency+1 ms or less) 3) Internal current consumption (5VDC:140mA->230mA)
250VAC, 1.2A, Terminal block, 8 outputs	250VAC, 1.2A, Terminal block, 8 outputs		
C200H-OA224	CS1W-OA211	Triac Output Units with terminal block for 12 outputs. Replace this unit with a Triac Output Unit with 16 outputs.	1) Terminal block 2) Output points (12 -> 16 points) 3) Number of circuit (12 points/common x1 circuit ->8 points/common x2 circuits) 4) Output circuit specification Max. Switching Capacity (0.5 A 250 V AC, 2 A/Unit -> 0.5 A 250 V AC, 2 A/common, 4 A/Unit) Max. Inrush Current (10A: pulse width: 100 ms, 20A: pulse width: 10 ms-> 15A: pulse width: 10ms) Min. Switching Capacity (10VAC: 100mA, 24VAC: 50mA, 100VAC: 10mA->75VAC: 50mA) Residual voltage (1.5 V AC max. (50 to 500 mA)/5 -> 1.6 VAC (10 to 50 mA) 5) Internal current consumption (5VDC:270mA->406mA)
0.5 A 250 V AC, 0.5A, Terminal block, 12 outputs	0.5 A 250 V AC, 0.5A, Terminal block, 16 outputs		
C200H-OA222V	CS1W-OA211	Triac Output Units with terminal block for 12 outputs. Replace this unit with a Triac Output Unit with 16 outputs.	1) Terminal block 2) Output points (12 -> 16 points) 3) Number of circuit (12 points/common x1 circuit ->8 points/common x2 circuits) 4) Output circuit specification Max. Inrush Current (No regulation ->15A: Pulsewidth 10ms) Min. Switching Capacity (10 VAC: 10 mA (resistive load)/40 mA (inductive load) -> 75VAC:50mA Residual voltage(1.2VAC->1.6VAC) ON response time (1/2 of load frequency or less -> 1 ms or less) OFF response time (1/2 of load frequency or less-> 1/2 of load frequency+1 ms or less) 5) Internal current consumption (5VDC:200mA->406mA)
250 V AC, 0.3A, Terminal block, 12 outputs (CE)	0.5 A 250 V AC, 0.5A, Terminal block, 16 outputs		

■Input/Output Units

- (1) The CS-series has two Input/Output Units: CS1W-MD261 and MD561. The unit area allocation is different from C200H-series input/output units, since the number of input/output of CS-series unit is 32 points each.
- (2) C200H-series Units can be used with CS1-series CPU Unit.
- (3) Refer to related manuals for details, even if functions of C200H-series are supported by CS1-series Units, since a part of specifications may differ.

<DC Input/Transistor Output Unit>

C200H-series Unit	Corresponding CS-series Unit	Description	Difference
C200H-MD115 12VDC/16 inputs, 12VDC/16 outputs (Sinking), Connector (Special I/O)	No replacement model	Input/Output Unit with connector for 16 inputs/16 outputs. The CS-series does not have the same type of Unit. Use this Unit with CS1, or use CS1W-MD261 or MD561 instead.	
C200H-MD215 24VDC/16 inputs, 5 to 24VDC/16 outputs (Sinking), Connector (Special I/O)	No replacement model	Input/Output Unit with connector for 16 inputs/16 outputs. The CS-series does not have the same type of Unit. Use this Unit with CS1, or use CS1W-MD261 or MD561 instead.	

<TTL Input/Output Units>

C200H-series Unit	Corresponding CS-series Unit	Description	Difference
C200H-MD501 5 VDC/16 inputs, 5 VDC/16 outputs, Connector (Special I/O)	No replacement model	Input/Output Unit with connector for 16 inputs/16 outputs. The CS-series does not have the same type of Unit. Use this Unit with CS1, or use CS1W-MD261 or MD561 instead.	

OMRON Corporation Industrial Automation Company

Tokyo, JAPAN

Contact: www.ia.omron.com

Regional Headquarters

OMRON EUROPE B.V.

Wegalaan 67-69-2132 JD Hoofddorp
The Netherlands
Tel: (31)2356-81-300/Fax: (31)2356-81-388

OMRON ELECTRONICS LLC

One Commerce Drive Schaumburg,
IL 60173-5302 U.S.A.
Tel: (1) 847-843-7900/Fax: (1) 847-843-7787

OMRON ASIA PACIFIC PTE. LTD.

No. 438A Alexandra Road # 05-05/08 (Lobby 2),
Alexandra Technopark,
Singapore 119967
Tel: (65) 6835-3011/Fax: (65) 6835-2711

OMRON (CHINA) CO., LTD.

Room 2211, Bank of China Tower,
200 Yin Cheng Zhong Road,
PuDong New Area, Shanghai, 200120, China
Tel: (86) 21-5037-2222/Fax: (86) 21-5037-2200

Authorized Distributor:

© OMRON Corporation 2010-2011 All Rights Reserved.
In the interest of product improvement,
specifications are subject to change without notice.

Printed in Japan
0611(1210)

Cat. No. P069-E1-03