

V750-series UHF RFID System

Operation Manual

Reader/Writer Antenna

V750-BA50C04-US (Mono-static Reader/Writer)
V740-HS01CA (Circular Antenna)
V740-HS01LA (Linear Antenna)

PRECAUTIONS

Please read and understand this manual before using the products. Please consult your OMRON representative if you have any question or comments.

Warranty, Limitations of Liability

WARRANTY: OMRON'S EXCLUSIVE WARRANTY IS THAT THE PRODUCTS ARE FREE FROM DEFECTS IN MATERIALS AND WORKMANSHIP FOR A PERIOD OF ONE YEAR (OR OTHER PERIOD IF SPECIFIED) FROM DATE OF SALE BY OMRON.

OMRON MAKES NO WARRANTY OR REPRESENTATION, EXPRESS OR IMPLIED, REGARDING NON-INFRINGEMENT, MERCHANTABILITY, OR FITNESS FOR PARTICULAR PURPOSE OF THE PRODUCTS. ANY BUYER OR USER ACKNOWLEDGES THAT THE BUYER OR USER ALONE HAS DETERMINED THAT THE PRODUCTS WILL SUITABLY MEET THE REQUIREMENTS OF THEIR INTENDED USE. OMRON DISCLAIMS ALL OTHER WARRANTIES, EXPRESS OR IMPLIED.

LIMITATIONS OF LIABILITY: OMRON SHALL NOT BE RESPONSIBLE FOR SPECIAL, INDIRECT, OR CONSEQUENTIAL DAMAGES, LOSS OF PROFITS OR COMMERCIAL LOSS IN ANY WAY CONNECTED WITH THE PRODUCTS, WHETHER SUCH CLAIM IS BASED ON CONTRACT, WARRANTY, NEGLIGENCE, OR STRICT LIABILITY.

IN NO EVENT SHALL THE RESPONSIBILITY OF OMRON FOR ANY ACT EXCEED THE INDIVIDUAL PRICE OF THE PRODUCT ON WHICH LIABILITY IS ASSERTED.

IN NO EVENT SHALL OMRON BE RESPONSIBLE FOR WARRANTY, REPAIR, OR OTHER CLAIMS REGARDING THE PRODUCTS UNLESS OMRON'S ANALYSIS CONFIRMS THAT THE PRODUCTS WERE PROPERLY HANDLED, STORED, INSTALLED, AND MAINTAINED AND NOT SUBJECT TO CONTAMINATION, ABUSE, MISUSE, OR INAPPROPRIATE MODIFICATION OR REPAIR.

Application Precautions, Change in Specifications

SUITABILITY FOR USE : OMRON SHALL NOT BE RESPONSIBLE FOR CONFORMITY WITH ANY STANDARDS, CODES, OR REGULATIONS THAT APPLY TO THE COMBINATION OF THE PRODUCTS IN THE CUSTOMER'S APPLICATION OR USE OF THE PRODUCT.

TAKE ALL NECESSARY STEPS TO DETERMINE THE SUITABILITY OF THE PRODUCT FOR THE SYSTEMS, MACHINES, AND EQUIPMENT WITH WHICH IT WILL BE USED.

KNOW AND OBSERVE ALL PROHIBITIONS OF USE APPLICABLE TO THIS PRODUCT.

NEVER USE THE PRODUCTS FOR AN APPLICATION INVOLVING SERIOUS RISK TO LIFE OR PROPERTY WITHOUT ENSURING THAT THE SYSTEM AS A WHOLE HAS BEEN DESIGNED TO ADDRESS THE RISKS, AND THAT THE OMRON PRODUCT IS PROPERLY RATED AND INSTALLED FOR THE INTENDED USE WITHIN THE OVERALL EQUIPMENT OR SYSTEM.

CHANGE IN SPECIFICATIONS : PRODUCT SPECIFICATIONS AND ACCESSORIES MAY BE CHANGED AT ANY TIME BASED ON IMPROVEMENTS AND OTHER REASONS. CONSULT WITH YOUR OMRON REPRESENTATIVE AT ANY TIME TO CONFIRM ACTUAL SPECIFICATIONS OF PURCHASED PRODUCT.

Declarations

Regulatory Compliance

EMC 47 CFR, Part 15
..... RSS210

FCC WARNING: Changes or modifications not expressly approved by the party responsible for compliance could void the user's authority to operate the equipment.

FCC COMPLIANCE: This equipment complies with Part 15 of the FCC rules for intentional radiators and Class A digital devices when installed and used in accordance with the operation manual. Following these rules provides reasonable protection against harmful interference from equipment operated in a commercial area. This equipment should not be installed in a residential area as it can radiate radio frequency energy that could interfere with radio communications, a situation the user would have to fix at their own expense.

EQUIPMENT MODIFICATION CAUTION: Equipment changes or modifications not expressly approved by OMRON Corporation, the party responsible for FCC compliance, could void the user's authority to operate the equipment and could create a hazardous condition.

IMPORTANT USER INFORMATION: This equipment complies with FCC radiation exposure limits set forth for uncontrolled equipment and meets the FCC radio frequency (RF) Exposure Guidelines in Supplement C to OET65. This equipment should be installed and operated with at least 23cm (9.1in) and more between the radiator and person's body (excluding extremities: hands, wrists, feet and legs).

This device complies with RSS-Gen of IC Rules. Operation is subject to the following two conditions:

(1) this device may not cause interference, and (2) this device must accept any interference, including interference that may cause undesired operation of this device.

Safety UL 60950
..... Can/CSA C22.2 No 60950

IMPORTANT USER INFORMATION: For products numbered with 0001X06 to 0048X06, only AC adapter complies with UL 60950. For products numbered with 0049X06 or later, AC adapter and the V750 Reader/Writer comply with UL 60950.



©Copyright OMRON Corporation 2006. All rights reserved.

This document is protected by copyright and is intended solely for use in conjunction with the product. Notify your OMRON representative before copying or reproducing this document in any manner, for any other purpose.

Safety Precautions

This chapter provides important information for the safe use of this product.
Ensure to read the information carefully before use.

IN THE SAFETY PRECAUTIONS BELOW, SEVERITY IS CATEGORIZED AS EITHER "WARNING" OR "CAUTION".

 WARNING	<p>Indicates a potentially hazardous situation which, if not avoided, could result in minor or moderate injury, or may result in serious injury or death. Additionally there may be significant property damage.</p>
 CAUTION	<p>Indicates a potentially hazardous situation which, if not avoided, may result in minor or moderate injury, or property damage. Property damage refers to extended damage caused to house/household goods or livestock/pets.</p>

•Description of Symbols



Prohibition

Indicates an action or activity not permitted.



Observe strictly

Indicates the need to ensure the safe use of the product.



Ensure to establish a solid grounding

A label indicating that a device with a grounding terminal should always be grounded.



Electric shock hazard

A notification that alerts the possibility of electric shock under certain conditions.



Do not disassemble

A notification that prohibits disassembly when injuries caused by electric shocks may result.

Please ensure that all cautions and prohibitions are adhered to, since non-compliance may lead to serious injury or damage, in certain circumstances.

 **WARNING**



Never disassemble, repair, or modify the main unit and cables.

- Do not disassemble, repair, or modify this product. Doing so may result in electric shock, fire, or personal injury.



Do not handle the device with wet hands. Do not touch the terminals while the device is connected to the power supply.

- Electric shock hazard.



Do not allow the cables to be in contact with heaters.

- The cable sheaths may melt and the exposed wire may cause electric shock or fire.



Do not use the power cords and power adapters not supplied with the products.

- Failure to do so may result in electric shock, fire, or personal injury.



Connect and disconnect cables as described in the following procedures when installing, moving, on this product or attached devices.

To connect:

1. Attached all cables to devices.
2. Attached power cords to outlet.

To disconnect:

1. Remove power cords from outlet.
2. Remove all cables from devices.

Failure to do so may result In spark or deform or damage the device.



Always turn OFF the power supply to the PC before attempting any of the following. Not turning OFF the power supply may result in malfunction or electric shock.

- Assembling the Units.
- Connecting or disconnecting the Expansion I/O Units or Expansion Units.
- Connecting or wiring the cables.
- Connecting or disconnecting the connectors.

CAUTION



Do not drop the device you may receive major shocks.

- Doing so may result in personal injury or device damage.



Do not apply strong force to, or place heavy items on the device or cables.

- Doing so may deform or damage the device, resulting in electric shock or fire.



Use and store the product in an environment that is specified in the catalog or operation manual.

- Failure to do so may cause failure of the device, electric shock, or fire. Do not use or store the devices (Reader, antenna ,antenna cable) in the following locations:
 - Locations that do not satisfy the specified operating conditions (-10 to +50 , 25%RH to 85%RH,non-condensing).
 - Locations that do not satisfy the specified storage conditions (-25 to +65 , 25%RH to 85%RH,non-condensing).
 - Locations where the reader is exposed to direct sunlight.
 - Locations where the reader is exposed to dust, corrosive gas, saline, or flammable gas.
 - Locations where the reader is exposed to direct heat.
 - Locations subject to condensation due to high humidity.
 - Locations subject to vibration or impact that exceed the limits outlined in the specifications.
 - Locations where the device may be exposed to water, oil, or chemical agents. (This applies to the models other than waterproof types.)
 - Outdoor



Be sure to tighten the devices screws securely.

- Failure to do so may result in personal injury or device damage.















Cables with screw attachments must be secured before use.

- Failure to do so may damage the device.



To avoid interferences with other systems, adhere to the following items and check them before using the product.

- The product uses a publicly available ISM frequency band of 902-928MHz to communicate with Tags. Some transceivers, motors, monitoring devices, power supplies (power supply ICs), and other similar RFID systems may generate noise, which cause radio interference and may affect communication with Tags. If the product is required in the vicinity of these items, check for any interferences prior to use.
- On the contrary, the system itself may affect radio station transmissions or medical devices. Be cautious when using the system in the environments where such effects might occur.
- To minimize noise effects, adhere to the following:
 - Establish a Class D grounding (former Class 3 grounding) for metal objects placed in the vicinity of the system.
 - Keep cables away from those with high voltages or heavy currents.

	<p>Do not allow the device or cables to be exposed to water.</p> <ul style="list-style-type: none"> • Doing so may result in electric shock, fire or failure of non-waterproof devices or cables.
	<p>If the device fails or is exposed to water (non-waterproof devices or parts), or an unusual smell, smoke, or sparks are detected, immediately refrain from using the device and contact OMRON or a sales representative for service and repair.</p> <ul style="list-style-type: none"> • Continued use of the failed device may result in electric shock or fire.
	<p>Do not use damaged cables.</p> <ul style="list-style-type: none"> • Continued use of the damaged cables may result in electric shock or fire.
	<p>Fail-safe measures must be taken by the customer to ensure safety in the event of incorrect, missing, or abnormal signals caused by broken signal lines, momentary power interruptions, or other causes.</p>
	<p>Be sure that all the mounting screws, terminal screws, and cable connector screws are tightened to the torque specified in the relevant manuals. Incorrect tightening torque may result in malfunction.</p>
	<p>Be sure that terminal blocks and connectors are connected in the specified direction with the correct polarity. Not doing so may result in malfunction. If the power supply for the I/O circuits is turned ON with the input and output connectors reversed, the fuse of output transistor may be blown.</p>
	<p>Do not apply voltages to the input terminals in excess of the rated input voltage. Excess voltages may result in burning.</p>
	<p>Do not apply voltages or connect loads to the output terminals in excess of the maximum switching capacity. Excess voltage or loads may result in burning.</p>
	<p>When transporting the Units, use special packing boxes. Be careful not to apply excessive vibration or shock, or not to expose to water during transportation and not to drop the product.</p>
	<p>Do not install or keep the V750-BA50C04-US in the following locations:</p> <ul style="list-style-type: none"> -Locations subject to shock or vibration. -Locations subject to condensation as the result of severe changes in temperature. -Where the device may be exposed to water, oil, chemicals or organic solvents.
	<p>Do not use the system in an environment subject to flammable, explosive, or corrosive gases.</p>
	<p>Provide an enough space around the device for ventilation</p>







	Keep cables away from those with high voltages or heavy current.
	To avoid interferences with other systems, adhere to the following items and check them before using the product: -The product uses a publicly available ISM frequency band of 902-928MHz to communicate with Tags. Some transceivers, motors, monitoring devices, power supplies, and other similar RFID systems may generate noise, which cause radio interference and may affect communication with Tags. If the product is required in the vicinity of these items, check for any interferences prior to use.
	In order to comply with FCC requirements for RF exposure safety, a separation distance of at least 23cm(9.1in) needs to be maintained between the radiating elements of the antenna and the bodies of nearby persons.
	To avoid interferences with other systems, adhere to the following items and check them before using the product: -On the contrary, the system itself may affect radio station transmissions or medical devices. Be cautions when using the system in the environments where such effects might occur.
	Keep cables away from those with high voltages or heavy current.
	Properly shielded a grounded cables and connectors must be used for connection to host computer and / or peripherals in order to meet FCC emission limits.
	The machine installation, operation and maintenance should be carried out by “properly trained” person.

Table of Contents

Feature of V750 series RFID system	11
1. Installation and Usage Guide	14
1.1 Before You Begin.....	14
1.1.1 Installation Requirements.....	14
1.1.2 Performance Considerations.....	14
1.2 Reader Specification.....	16
1.2.1 General Specifications	16
1.2.2 Outline Drawing.....	16
1.2.3 Characteristics.....	17
1.3 Authorized Antennas	18
1.3.1 Antennas	18
1.3.2 Antenna Cables.....	18
1.3.3 Setting the reader RF Power.....	19
1.4 Reader Installation	20
1.4.1 Install the Reader	20
1.4.2 Install the Antennas.....	21
1.4.3 Connect the Reader	22
1.4.4 Antenna Port	23
1.4.5 Status Indicators.....	25
1.4.6 I/O Interface.....	27
1.4.7 RS-232C Interface.....	32
1.4.8 Ethernet Interface.....	34
2. Functions and Control	35
2.1 Reader Operating Mode	35
2.2 System Interface	36
2.2.1 Command I/F Function.....	36
2.2.2 Reader Configuration	37
2.2.3 Web Browser Function.....	38
2.3 Functions	39
2.3.1 Command Execution	39
2.3.2 Digital Input / Output	39
2.3.3 Self-Operation	40
2.3.4 Firmware Update.....	41
2.4 Communication	42
2.4.1 Communication Process	42
2.4.2 Communication Sequence	43
2.4.3 Antenna Sequence.....	49
2.4.4 Session Setting	50
2.4.5 Communication Data Control.....	51
2.5 Tag Fundamentals	52
3. Command Line Interface	53
3.1 Command Interface	53
3.1.1 Command / Response Frame Structure	53
3.1.2 Command Code List	56
3.1.3 Response Code List.....	57
3.1.4 Command / Response Format.....	59
3.1.5 Command Specification	61

3.1.5.1 Communication Command.....	61
3.1.5.2 Reader Status, Reader Settings Function	71
3.1.5.3 Communication Settings	75
3.1.5.4 Operation Settings	79
3.1.5.5 Control Command	84
3.2 Examples	92
3.2.1 Example 1	92
3.2.2 Example 2	92
3.2.3 Example 3	93
3.2.4 Example 4	94
3.2.5 Example 5	96
4. Browser-Based Interface	97
4.1 Using the Browser-Based Interface	97
4.2 Operation Mode	98
4.2.1 Page List	98
4.2.2 Status	99
4.2.3 Reader Settings.....	102
4.2.4 Communication Settings	105
4.2.5 Operation Settings.....	108
4.2.6 Communication Test	111
4.2.7 Utility.....	113
4.2.7.1 Latest Error Logging.....	113
4.2.7.2 History of Error Logging	115
4.2.7.3 Noise Check	117
4.2.8 Firmware Update.....	119
4.3 Safe Mode.....	120
4.3.1 Status Page.....	120
4.3.2 Firmware Update Page	122
4.4 Update Mode	123
5 Communication Performance (Reference)	125
5.1 Communications Range	125
5.2 Communications Time	126
APPENDIX: OUTLINE DRAWINGS.....	128
Reader / Writer: (V750-BA50C04-US)	128
Antenna: (V740-HS01CA, V740-HS01LA).....	129
Antenna Cable: (V740-A01-3.0M, V740-A01-10M)	130

Feature of V750 series RFID system

V750 Series RFID Reader, Antenna

Operation Manual



V750-BA50C04-US Mono-static Reader
(4ports)

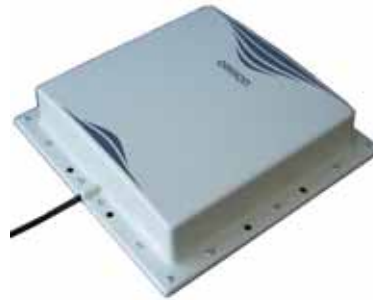

V740-HS01CA Mono-static
Antenna (Circular)
V740-HS01LA Mono-static
Antenna (Linear)

The OMRON V750 RFID Reader (herein after denoted as the reader) uses RFID (radio frequency identification) technology to read data stored on RFID tags.

The reader supports UHF (ultra high frequency) antennas, which are available separately. The reader receives tag data through the UHF antenna and transfers data to a remote computer over a network connection.

FCC WARNING

Changes or modifications not expressly approved by the party responsible for compliance could void the user's authority to operate the equipment.

NOTICE

This equipment has been tested and found to comply with the limits for a Class A digital device, pursuant to part 15 of the FCC Rules. These limits are designed to provide reasonable protection against harmful interference when the equipment is operated in a commercial environment.

This equipment generates, uses and can radiate radio frequency energy and, if not installed and used in accordance with the instructions, may cause harmful interference to radio communications. Operation of this equipment in a residential area is likely to cause harmful interference in which case the user will be required to correct the interference at his own expense.

Properly shielded a grounded cables and connectors must be used for connection to host computer and / or peripherals in order to meet FCC emission limits.

(AC adaptor) with ferrite core must be used for RF interference suppression.

V750-series Radio wave propagative RFID system is ideal for long range communication and for the system construction used in the production process or distribution control.

It is designed to have “High read range”, “Quick response” and “Simple operation”.

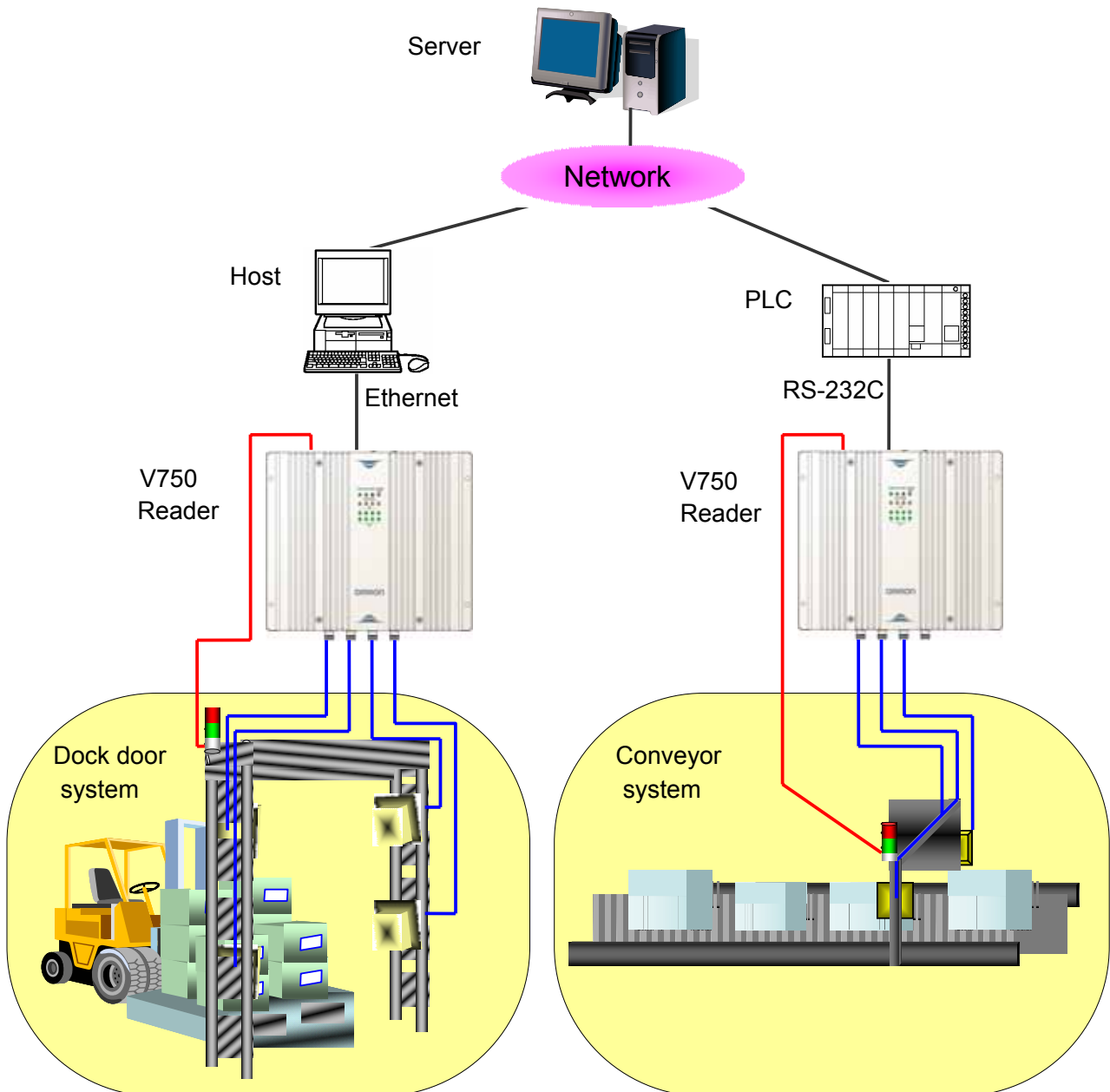

Main Features

(1) Well-tuned communication performance and functions for customers' applications

- 1) Selective communication modes for various applications
Single access mode: reads a tag in high speed if there is a single tag in the communication field.
Multi access mode: optimizes a sequence automatically according to the number of tags existing in the communication field.
- 2) Various communication condition setting
Multiple communication conditions suit user's optional usage.
- 3) Self-operation function
Using two function; command entry function and programmable output function, the reader can implement simple judgment or processing without instruction from the host.
 - Command entry
Can set a command so that the command starts when power is turned on or input terminal signal is on.
 - Programmable output
4 outputs can be used for output terminals to show reader status or communication results.
When the output terminal is used for communication results, the result conditions can be set by choosing criteria objective such as data value or tag count.

(2) Rich maintenance functions and on-site verification functions

- 1) Monitoring and setting via Web browser.
Via Web browser, you can get an operation status or setting conditions and set the operation parameters easily.
- 2) Communication monitoring function that reduces the installation time
A tag communication testing function, an on-site environmental monitoring function (a noise check for each channel), and an error logging function are equipped. These functions show the status of radio waves and enable you to verify performance of tag-reader or analyze phenomena that may change depending on on-site RF environment.
- 3) Multiple LED operation displays
The multiple LED indicators show the reader operation status clearly and simply so that you can understand the status and handle an error quickly if it happens to occur.
- 4) Automatic antenna detection
This function enables you to check the connection status of antennas when a command is executed. It helps to detect an error or problem of antenna(s) or wiring.

(3) Expandability applicable to broad usage

Firmware upgradable

Via Web browser on the PC, you can upgrade its firmware. It means that the functions are expandable.

1. Installation and Usage Guide

About this Guide

This installation and usage guide explains how to install the V750 reader, how to use the browser-based interface, and how to control the reader remotely.

1.1 Before You Begin

1.1.1 Installation Requirements

- The reader is shipped with a power source with a cable length of 4.2m (13ft 9in).
- Use only authorized antennas and cables to maintain FCC approval.
- In order to comply with FCC requirements for RF exposure safety, a separation distance of at least 23 cm (9.1in) needs to be maintained between the radiating elements of the antenna and the bodies of nearby persons.
- Provide strain relief for all reader connections.
- The minimum screw size for mounting the reader is M4. Use suitable wall anchors when mounting to drywall or masonry whose thickness is 16mm or more.(Refer to 1.4.1 Install the reader)
- A Shielded Ethernet cable must be used to communicate with other devices.
- Multiple readers and antennas can be used in combination to enhance detectability at specific locations provided the software application is able to synchronize antenna operation.

1.1.2 Performance Considerations

Reader performance may be affected by external factors including tag variables and environment.

Performance tests conducted under typical operating conditions at your site are recommended to help you to optimize system performance.

Tag Variables

There are several variables associated with tags that can affect reader performance:

- Application surface — Some materials interfere with tag performance including metal and moisture. Tags applied to items made from or containing these materials may not perform as expected.
- Tag orientation — Reader performance is affected by the orientation of the tag in the antenna field.
- Tag model — many tag models are available. Each model has its own performance characteristics (refer to Chapter 2.5).

Environment

Reader performance may be affected by the following:

- Metal surfaces such as desks, filing cabinets, bookshelves, and waste cans may enhance or degrade reader performance.

Mount antennas as far as possible from metal surfaces that are adversely affecting system performance.

- Devices that operate at 900 MHz, such as cordless phones and wireless LANs, can interfere with reader performance. These devices may degrade performance of the reader. The reader may also adversely affect performance of 900 MHz devices.
- Antennas operating in close proximity may interfere with one another, thus degrading reader performance.
- Interference from other antennas may be eliminated or reduced by using either one or both of the following strategies:
 - Affected antennas may be synchronized by a separate user application using a time-multiplexing strategy.
 - Antenna power can be reduced by reconfiguring the RF Transmit Power setting for the reader.

1.2 Reader Specification

1.2.1 General Specifications

General Specifications

Item	Specification
Power supply (Electric power consumption)	DC12V, via attached AC Adapter.(Less than 28W)
Operation temperature	-10° to 50°C (14° to 122°F)
Humidity	25 to 85%RH non-condensing
Storage temperature	-25° to 65°C (-13° to 149°F)
Dimensions	246 x 215 x 43.5mm (9.7 x 8.5 x 1.7 inch)
Protection class	IP50
Vibration resistance	10 to 150 Hz, Amplitude: 0.1mm
Shock resistance	150m/s ² (15G)
Case material	Aluminum
Weight	1.4kg (3.1 lbs)
Mounting	4 point screw (M4)

1.2.2 Outline Drawing

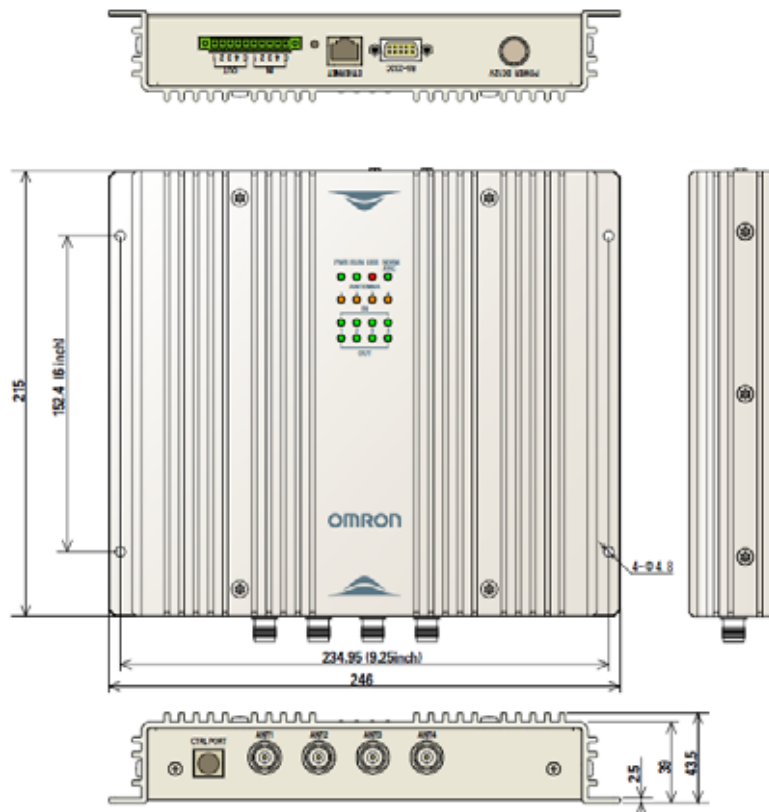

1.2.3 Characteristics

Characteristics

Item	Specification
Supported tag	EPC Class1 Generation 2 (C1G2)
UHF operating frequency	902.75–927.25MHz FHSS (Frequency Hopping Spread Spectrum) 50ch
Antenna output	30dBm, 4W EIRP (Changeable for each antennas.)
Connected antenna(s)	V740 Series UHF Antenna x 4 ports (V740-HS01CA or V740-HS01LA)
Control method	V750 original command/response
Control port	Ethernet Supported standard: IEEE802.3 compliance (10Base-T) IEEE802.3u compliance (100Base-TX) Supported protocol: TCP/IP Port:7090 (Changeable)
	RS-232C Supported standard: RS-232C compliance Baud rate: 9.6 / 19.2 / 38.4 / 57.6 kbps Data length: 7 / 8 bits Parity: Even / Odd / None Stop bit: 1 / 2 bit
Browser interface	Ethernet Protocol: HTTP Port:80 (Fixed) TCP/IP Port:7091 (Changeable)
Digital Input/Output	4 Inputs 4 Outputs
Status indicator	8 Operation status (POWER, RUN, ERR, NORM/ERC, ANTENNA1-4) 4 Input status 4 Output status
Self diagnostic function	(1) CPU operation check (2) Antenna connecting check (3) Communication error detection with tags
Scalability	(1) Software upgradable (2) Antenna control port

1.3 Authorized Antennas

The antenna authorized by the FCC for use with the V750 reader is described below.

IMPORTANT: No other antennas may be used with the V750 reader without violating FCC regulations. It is the responsibility of the user to comply with this requirement.

1.3.1 Antennas

Mono-static Circular Antenna (Options)

Model:	V740-HS01CA
Polarization:	Circular
Operating frequency:	902–928MHz
Gain:	6dBi max.
Impedance:	50ohm
V.S.W.R:	< 1.5 :1
Connector:	N-Female
Cable length:	0.3m (0.98')
Dimension:	256 x 256 x 57mm (10.1 x 10.1 x 2.3 in)
Weight:	1.0kg (2.3 lbs)
Protection:	IP50
Operating temperature:	-10° to 50°C (14° to 122°F)
Storage temperature:	-25° to 65°C (-13° to 149°F)
Relative humidity:	25 to 85%RH non-condensing

Mono-static Linear Antenna (Options)

Model:	V740-HS01LA
Polarization:	Linear
Operating frequency:	902–928MHz
Gain:	6dBi max.
Impedance:	50ohm
V.S.W.R:	< 1.5 :1
Connector:	N-Female
Cable length:	0.3m (0.98')
Dimension:	256 x 256 x 57mm (10.1 x 10.1 x 2.3 in)
Weight:	1.0kg (2.3 lbs)
Protection:	IP50
Operating temperature:	-10° to 50°C (14° to 122°F)
Storage temperature:	-25° to 65°C (-13° to 149°F)
Relative humidity:	25 to 85%RH non-condensing

1.3.2 Antenna Cables

The only cables authorized by the FCC for use with the V750 reader are listed below:

Short cable (Options)

Model:	V740-A01-3.0M
Length:	3.0m (9.8')
Insertion Loss:	1.5 dB min.
Cable Type:	3D-2V
Connector:	Reverse TNC to Type N
Cable Diameter:	5.5mm (0.22")

Long cable (Options)

Model:	V740-A01-10M
Length:	10m (32.8')
Insertion Loss:	1.5 dB min.
Cable Type:	5D-SFA
Connector:	Reverse TNC to Type N
Cable Diameter:	7.6mm (0.30")

1.3.3 Setting the reader RF Power

During initial installation, the reader must be properly configured to use the correct RF power to comply with FCC regulations. DO NOT increase the power beyond the recommended power setting as calculated below.

The maximum RF power is determined from antenna gain and antenna cable loss using the formula:

$$\text{Maximum RF power} = 36.0 \text{ dBm} - \text{Antenna Gain} + \text{Cable Loss}$$

For example, if the antenna has a maximum gain of 6 dBi, and the cable has a minimum loss of 1.5 dB, the maximum RF power that may be set is $(36.0 - 6.0 + 1.5) = 31.5 \text{ dBm}$.

The reader RF Power is set through the **Communication Settings Page** as described on Page107.

Note that in no case may the power be set higher than 32.0 dBm.

Recommended Power Settings

Antenna Type	Short Cable/Long Cable
V740-HS01CA V740-HS01LA	31.5 dBm

1.4 Reader Installation

The following parts are provided with the reader:

Part	Quantity	Part Number
V750-Reader	1	V750-BA50C04-US
AC Adapter	1	-
I/O Port Connector	1	MC 1,5/10-STF-3,81

IMPORTANT: Be sure the user reads the section on *Declarations* to maintain compliance with FCC regulations. The reader and the antennas are to be installed only by professionals at specific locations. For human safety, maintain a 23cm (9.1in) distance from the antennas.

IMPORTANT: This product is intended to be supplied by a Listed AC Adapter (Switching Power Adapter) marked LPS and rated 12 Vdc, 4 A

1.4.1 Install the Reader

You can place the reader on a shelf or mount it on a wall. A surface of the shelf or wall should be flat to fix the reader securely.

To mount the reader on a wall:

1. Hold the reader in its four mounting location and mark the position of the mounting screws

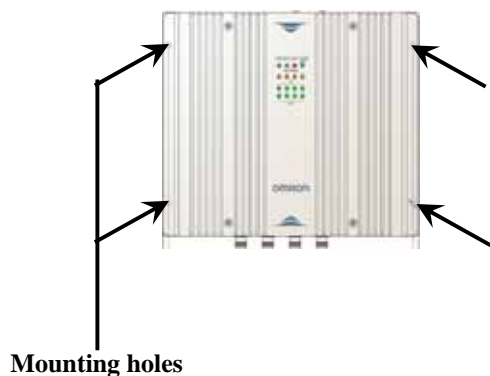

2. Drill holes for the screws and install wall anchors if required. Be sure anchors must have enough strength to fix the reader against vibration.
3. Hold the reader at the position on the mark and insert the M4x16 screws with spring washers and flat washers, and tighten until almost flush with the wall. Two persons (one for hold the reader and the other for tighten the screws) are required for this installation for the safety.
4. Tighten the screws securely.
5. Place the AC adaptor where it is not obstructed and fix it so that not to move by vibration and tense DC plug cables. Do not bundle the adaptor cable with other signal or power lines.

IMPORTANT: Be sure to remain within the rated voltage and current of the power cord and outlet.

Mechanical Loading - Mounting of the equipment in the rack should be such that a hazardous condition is not achieved due to uneven mechanical loading.

1.4.2 Install the Antennas

The antennas can be mounted directly to a variety of surfaces. Mounting surfaces should be flat to fix the antenna securely.

To mount the reader on a wall :

1. Hold the antenna in its mounting location and mark the position of the mounting screws with minimum (4) points. The antenna has several mounting holes for each side. Choose 4 of those with diagonal position according to the mounting location.

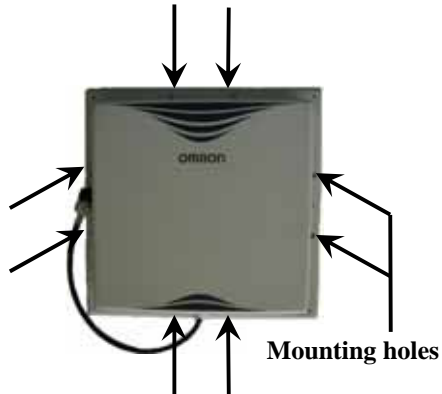

2. Drill holes for the screws and install wall anchors if required.
3. Insert the M4x20 screws with spring washers and flat washers and tighten until almost flush with the wall.
4. Tighten the screws securely.

Note: For best performance, mount the antenna in the horizontal orientation as pictured above.

1.4.3 Connect the Reader

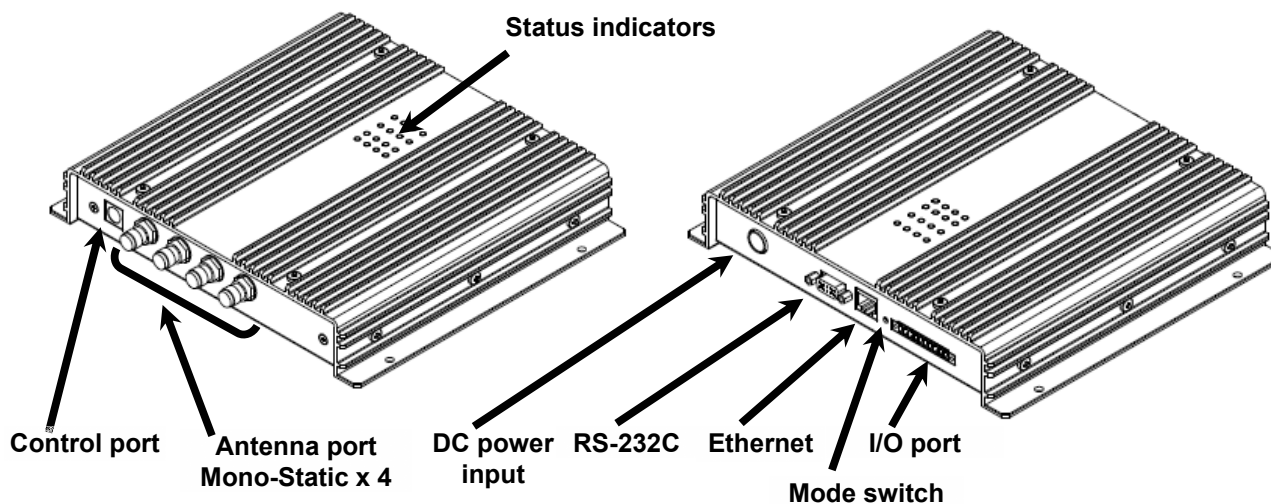

Interface name and function

Name	Function	Connector specifications
Antenna port [ANT1- ANT4]	Connects with UHF mono-static type antenna specified by OMRON via antenna cables. Max 4 antennas can be connected to.	Reverse TNC
Ethernet port [ETHERNET]	Connects with the host via a commercially available 10/100Base-T cable.	RJ-45 LED Left: Link, Right: Act
RS-232C port [RS-232C]	Connects with the host via a commercially available RS-232C cable for DOS/V PC.	D-sub 9pin (male) Inch screw (#4-40)
Input/Output port [IN 1,2,3,4,C] [OUT 1,2,3,4,C]	Connects to the input/output signal cable(s) via an attached I/O port adapter (MC 1,5/10-STF-3,81). 4 Inputs: connects with the sensor that works as a trigger signal for communication start. 4 Outputs: connects with the light or actuator that is driven by output signal.	MC 1,5/10-GF-3.81 (produced by PHOENIX CONTACT).
DC Power input [POWER DC12V]	Connects with the attachment AC adaptor to receive +12V electric power. * Extension of AC adaptor cable is not allowable.	Exclusive connector
Control port [CTRL PORT]	For future expansion.	Exclusive connector
Mode switch (Not indicated)	Pushing this button for 1 second or more makes the system rebooting with default setting, which will be functional in case of system error or setting unknown.	-

Note: MAC Address is displayed on the lower part of RJ-45 Ethernet port.

1.4.4 Antenna Port

One to four OMRON Mono-static antennas (V740-HS01CA, V740-HS01LA) can be connected to the reader, depending on the application requirements.

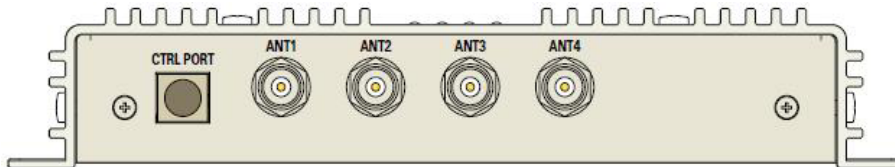

Connector: Reverse TNC

Name	Function
SG	Signal output
GND	Ground

1. Connect required UHF antennas to the antenna ports on the reader.

IMPORTANT: Connect antennas to the antenna ports before applying power to the reader. Any antenna port that has detected no antenna will be disabled when the reader is powered on.

Antenna Connection: V750-BA50C04-US



Antenna x 4
(V740-HS01CA or V740-HS01LA)

Antenna Cable x 4
(V740-A01-3.0M or V740-A01-10M)

Note: With the two antenna configuration, there is a possibility that a tag may be read by an inactive antenna if the tag is located with in approximately 20 cm of the inactive antenna with powered at 31.5 dBm.

2. Verify that all antennas are securely connected.

3. Connect the reader to the network by plugging a Shielded Ethernet cable into the Ethernet port.

or

Connect the reader to a PC (personal computer) by plugging a crossover Shielded Ethernet cable into the Ethernet port.

Note: If DHCP is to be used, then the network and server must be connected **before** powering up the reader. If a DHCP server is not found, the reader will fall back to the static IP address:

Default IP address: 192.168.1.200 (Subnet mask: 255.255.255.0, Gateway: 192.168.1.254)

4. Plug the power adapter provided with the reader into the DC power input connector. Then connect the AC power cord to a power outlet.

While the reader is powering up, the Power indicator is lighting. After the reader finishes its power-on self-test, approximately 5 seconds, 'RUN' indicator will turn on. The reader is now ready for operation.

IMPORTANT: DO NOT disconnect power during startup. Disconnecting power while booting the V750 reader may result in improper startup.

1.4.5 Status Indicators

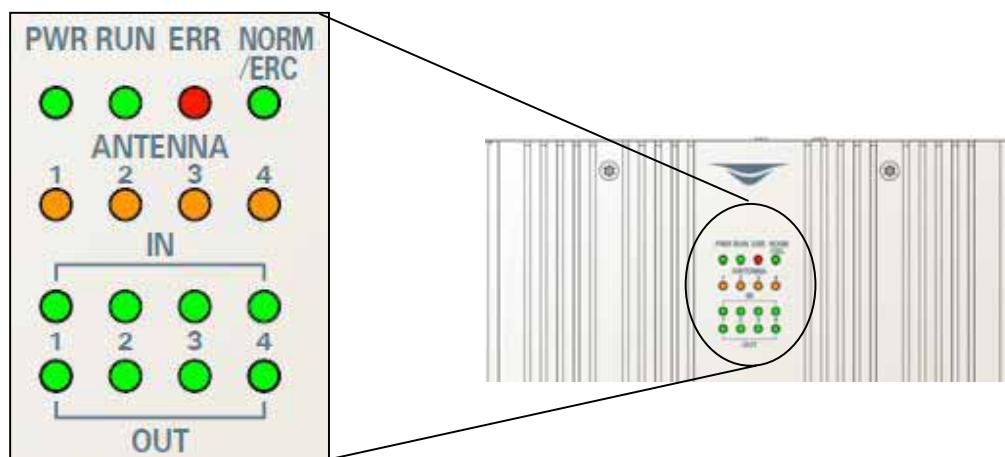

Status Indicators

Indicator	Name	Color	Status	Meaning
PWR	<u>P</u> ower	Green	ON	Normally energized.
RUN	<u>R</u> unning	Green	ON	Normally running.
			Flashing (Short interval) *	Boot processing.
			Flashing (Long interval) **	Safe Mode running.
ERR	Reader <u>e</u> rror RUN indicator off :Unrecoverable error RUN indicator on :Recoverable error	Red	ON	System error. The error has occurred and it stopped the system operation. ex. System error
			Flashing (Short Interval)*	Setting error. The error has occurred and it stopped by settings. ex. Power shut down in command communication ex. Communication setting error ex. Disconnection to the DHCP server
			Flashing (Long interval)**	Waiting for network connection.
NORM /ERC	Communication result : <u>N</u> ormal end	Green	ON	Command executed or communication with tag completed normally. (Turns off after 50ms ON or upon ERR LED turns on.)
	Communication result : <u>E</u> rror of <u>C</u> ommunication	Red	ON	Command executed or communication with tag completed abnormally. (Turn off after 50ms ON or upon NORM LED turns on.)

Indicator		Name	Color	Status	Meaning
ANTENNA	1	Antenna port #1	Orange	ON	Communication process is running via antenna #1. When connecting with an antenna via antenna #1 is detected after power turns on, it lights for 50ms.
	2	Antenna port #2	Orange	ON	Communication process is running via antenna #2. When connecting with an antenna via antenna #2 is detected after power turns on, it lights for 50ms.
	3	Antenna port #3	Orange	ON	Communication process is running via antenna #3. When connecting with an antenna via antenna #3 is detected after power turns on, it lights for 50ms.
	4	Antenna port #4	Orange	ON	Communication process is running via antenna #4. When connecting with an antenna via antenna #4 is detected after power turns on, it lights for 50ms.
IN	1	Input port #1	Green	ON	Signal of input port #1 is on.
	2	Input port #2	Green	ON	Signal of input port #2 is on.
	3	Input port #3	Green	ON	Signal of input port #3 is on.
	4	Input port #4	Green	ON	Signal of input port #4 is on.
OUT	1	Output port #1	Green	ON	Signal of output port #1 is on.
	2	Output port #2	Green	ON	Signal of output port #2 is on.
	3	Output port #3	Green	ON	Signal of output port #3 is on.
	4	Output port #4	Green	ON	Signal of output port #4 is on.

* Short interval: approx. 500ms cycle (On: 250ms, Off: 250ms)

** Long interval: approx. 3000ms cycle (On: 1500ms, Off: 1500ms)

1.4.6 I/O Interface

As an input/output port, the reader contains a terminal block of which connector is removable with screws.

Terminal block connector: MC 1,5/10-STF-3,81 (produced by PHOENIX CONTACT)

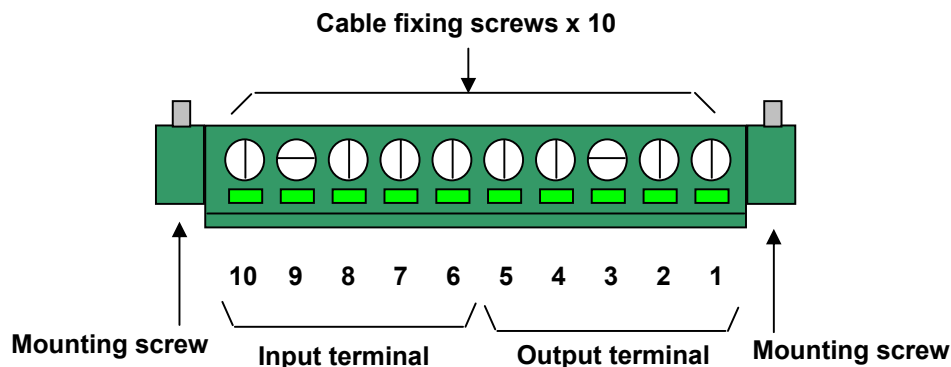

Pin assignment

Pin No	Name	I/O	Description
1	OUT 1	OUT	Output port #1
2	OUT 2	OUT	Output port #2
3	OUT 3	OUT	Output port #3
4	OUT 4	OUT	Output port #4
5	OUT_COM	-	Output common port
6	IN 1	IN	Input port #1
7	IN 2	IN	Input port #2
8	IN 3	IN	Input port #3
9	IN 4	IN	Input port #4
10	IN_COM	-	Input common port

How to wire a terminal block connector with signal cables(s) and how to connect it to the reader body.

- (1) Wire a signal cable(s) to the terminal block connector. *
 - Loosen the cable fixing screw(s) (anticlockwise) and insert the signal cable(s) all the way into the connector.
 - Tighten the cable fixing screw(s) (clockwise).
- (2) Mount the terminal block connector to the reader body.
- (3) Fasten the terminal block connector with 2 mounting screws.

*Required Tool: Slotted driver

*** Make sure to connect the signal cable to the terminal block connector prior to mounting the connector to the body.**

Input terminal specifications

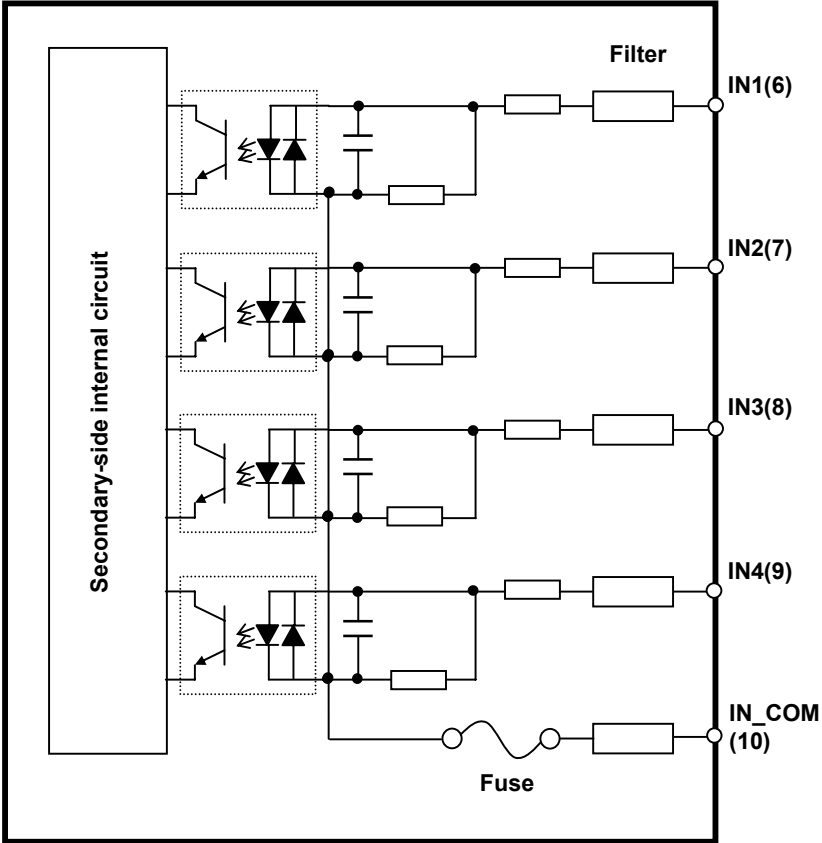
Item	Specifications
Number of input	4 inputs, 1 common input
Input method	Photo coupler
Input voltage	DC10.2 ~ 26.4V
Input impedance	2.35kΩ TYP.
Input current	12V: 4.5mA, 24V: 9.8mA TYP.
Wiring	<p data-bbox="496 555 911 584">Wiring in the input terminal block</p>  <p>The diagram illustrates the internal wiring of the input terminal block. On the left, a vertical box labeled 'Secondary-side internal circuit' contains four photo-coupler units. Each unit consists of an LED and a phototransistor. The LED is connected to the input terminal through a pull-up resistor. The phototransistor is connected to a common ground line. To the right of the photo-couplers, each input line passes through a 'Filter' (represented by a capacitor and a resistor) and a 'Fuse' before reaching the terminal. The terminals are labeled IN1(6), IN2(7), IN3(8), IN4(9), and IN_COM (10). The IN_COM terminal is connected to a common ground line that also serves as the reference for the pull-up resistors of the other inputs.</p>

Example of the wiring with peripheral devices

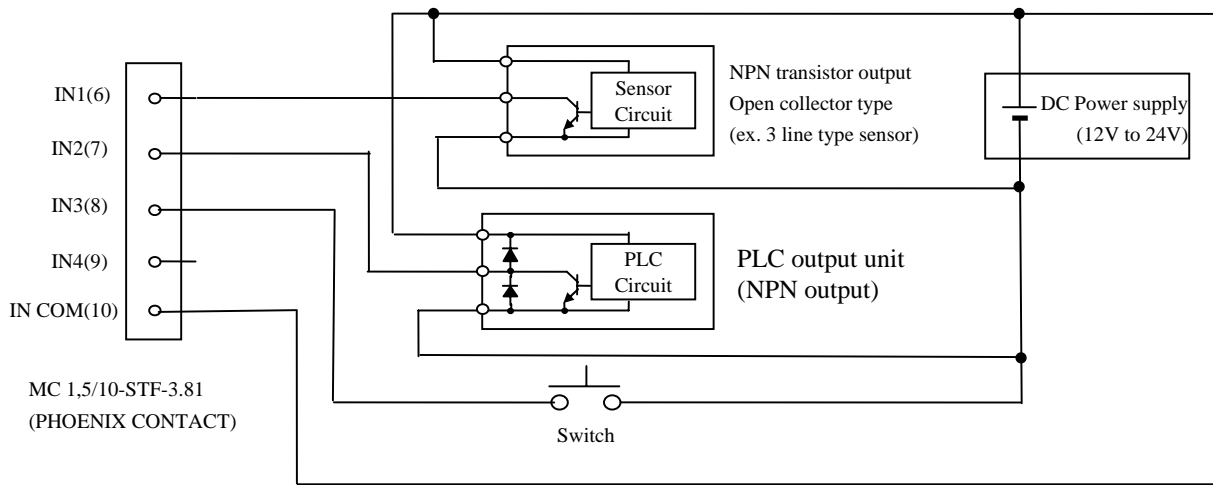

Output terminal specifications

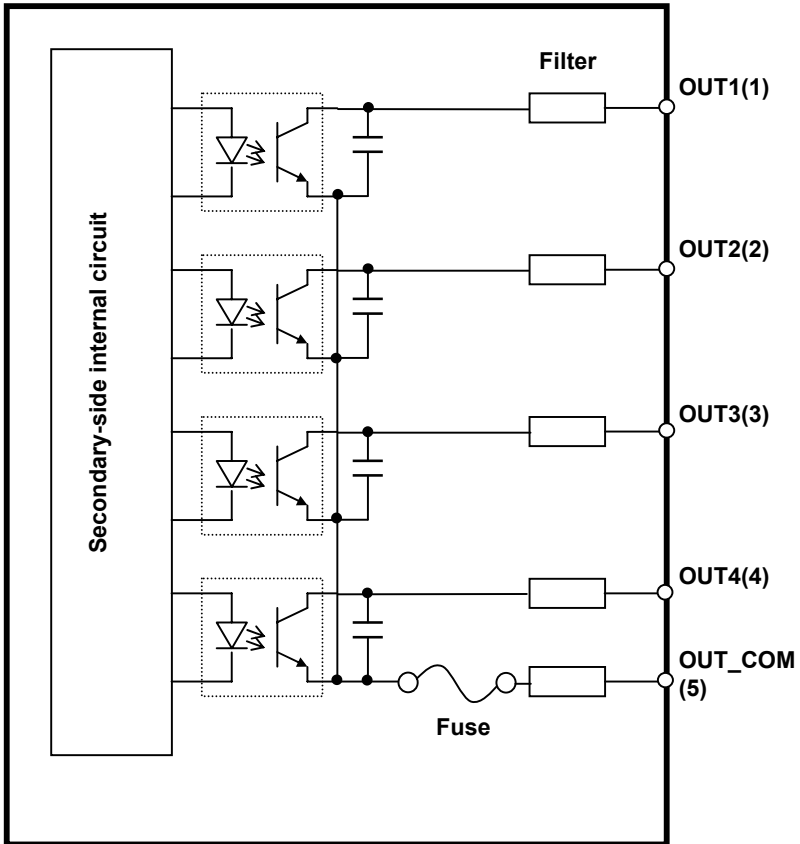
Item	Specifications
Number of output	4 outputs, 1 common output
Output method	Open collector output (Sync type: NPN)
Output maximum level	26.4V, 20mA
Leak current	Less than 0.1 μ A
$V_{CE(Sat)}$	Less than 5V (When output level is 20mA) Less than 2V (When output level is 10mA)
Wiring	<p data-bbox="528 577 959 611">Wiring in the output terminal block</p>  <p>The diagram illustrates the internal wiring of the output terminal block. On the left, a vertical block labeled 'Secondary-side internal circuit' provides input to four parallel output stages. Each stage consists of an NPN transistor with a diode connected in parallel across its collector and emitter. The collector of each transistor is connected to a common vertical bus. From this bus, four separate lines lead to output terminals labeled OUT1(1), OUT2(2), OUT3(3), and OUT4(4). Each of these lines passes through a rectangular component labeled 'Filter' before reaching the terminal. A fifth line from the common bus leads to a terminal labeled OUT_COM (5). This line passes through a circular component labeled 'Fuse' before reaching the terminal.</p>

Example of the wiring with peripheral devices

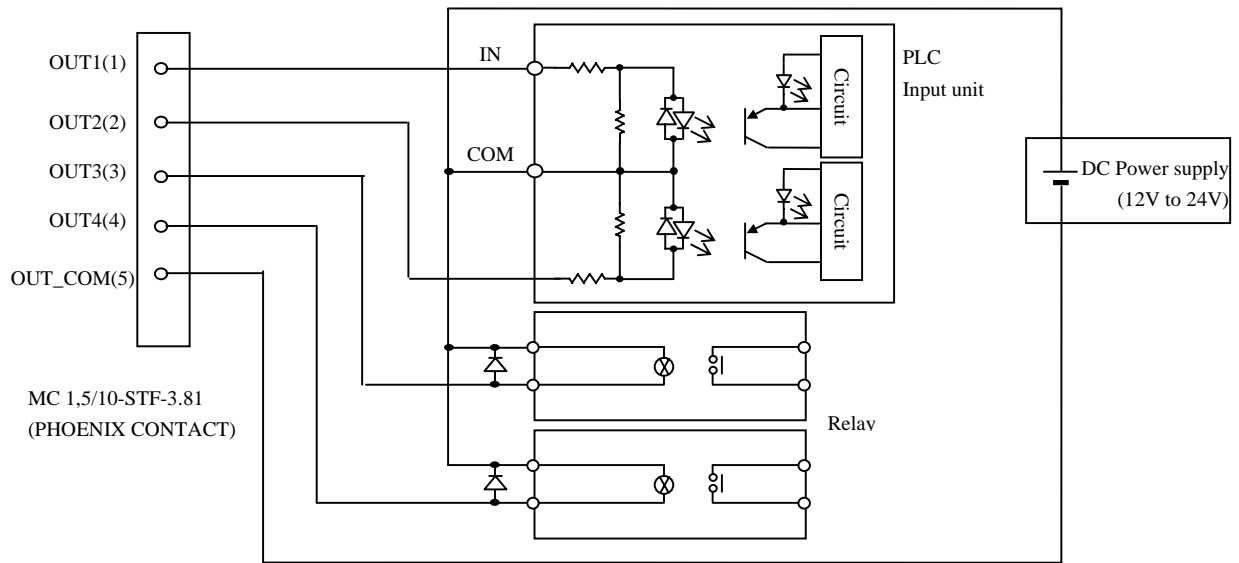

1.4.7 RS-232C Interface

This port is used to connect the reader to the host containing RS-232C interface such as PC or PLC (Programmable logic controller). If you use the PC as a host, prepare a cross cable to connect the PC to the port.

Connector: D-sub 9pin (male), inch screw (#4-40)

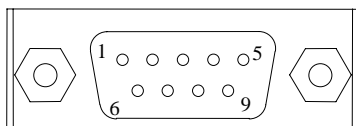

Pin assignment

Pin No	Name	I/O	Function
1	-	-	-
2	RD	IN	Receive Data
3	SD	OUT	Send Data
4	-	-	-
5	SG	-	Signal Ground
6	-	-	-
7	RS	OUT	Request to Send
8	CS	IN	Clear to Send
9	-	-	-

<Sample of connection>

Connecting to the PC: Serial setting is set for "flow control: none".

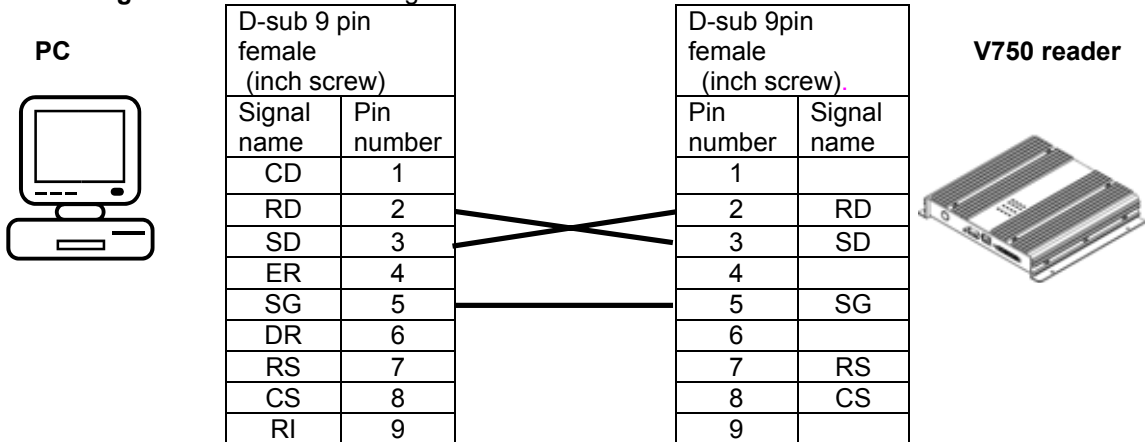

Connecting to the Omron's PLC (programmable logic controller):

Serial setting is set for "flow control: none".

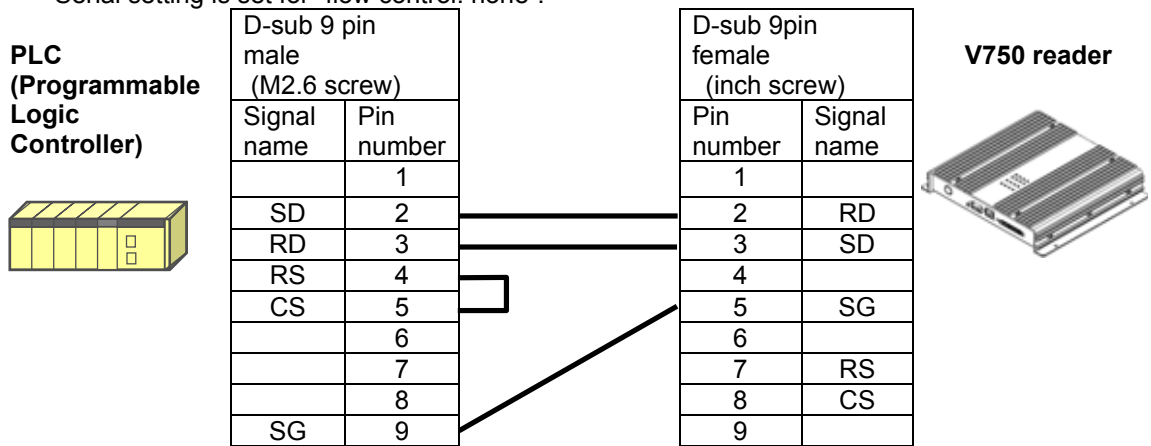

1.4.8 Ethernet Interface

This port is used to connect the host to the reader via Ethernet. To connect them, use the commercial cable 10/10Base-T.

Connector: RJ-45 (8 pin) LED: Link (green) / Act (orange)

Link --- lights while linking normally.

Act --- lights when detects a carrier.

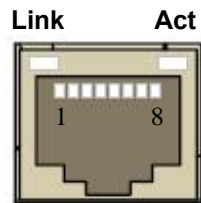

Pin assignment (MID type)

Pin No	Name	I/O	Function
1	TXD (+)	OUT	Transmit Data +
2	TXD (-)	OUT	Transmit Data -
3	RXD (+)	IN	Receive Data +
4	-	-	Reserved
5	-	-	Reserved
6	RXD (-)	IN	Receive Data -
7	-	-	Reserved
8	-	-	Reserved

2. Functions and Control

Reference Guide

This chapter lays the groundwork for the communication protocol between client software running on a remote computer and the V750 reader.

2.1 Reader Operating Mode

Reader operating mode contains three modes, Operation Mode, Safe Mode and Update Mode.

Mode	Function	Note
Operation Mode:	Under this mode, the reader communicates tags normally.	
Safe Mode:	Under this mode, the reader recovers or is maintained after error.	If you push the Mode Switch for 1 second or more and release the switch while the system is running, or if the reader detects an error (ex. System error or a failure of firmware update), and it can not start up normally due to this error, the reader will start up under Safe Mode. Under this mode, you can check the status via Web browser, initialize the setting and install the firmware.
Update Mode:	Under this mode, the reader updates firmware.	

2.2 System Interface

2.2.1 Command I/F Function

2.2.1.1 Ethernet, RS-232C Connection

Via 10/100BaseT Ethernet or RS-232C, the host issues a command to control the reader. As the control method, V750 supports original procedures. Same commands are used via Ethernet and RS-232C.

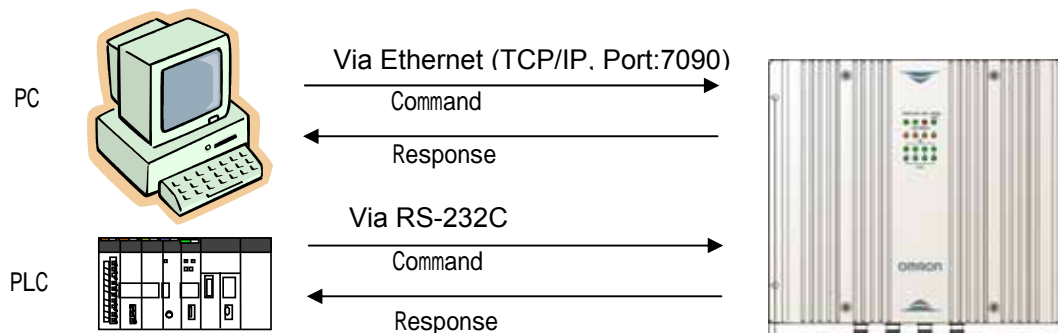

(1) Ethernet

Ethernet is connected with the host such as server computer via TCP/IP protocol.

IP address corresponds to dynamic IP address assigned by DHCP server. You can choose the static IP address (Default 192.168.1.200) or a dynamic IP address. Default setting is static IP address. The port 7090 is used by reader for communication. IP address and the port number (over 1024) can be changed by using a setting command or Web page. If the reader can not detect the DHCP server under dynamic IP address setting, it will flash the error indicator and start up with static IP address.

Ethernet network settings

Item	Factory-default
DHCP	Disable
IP Address	192.168.1.200
Subnet Mask	255.255.255.0
Gateway	192.168.1.254
Communication Port	7090

(2) RS-232C

The reader conforms to the RS-232C standard. It can connect with the host such as PLC. You can choose following communication conditions.

Optional communication conditions

Item	Factory-default	Setting value
Baud Rate (bps)	57600 bps	9600 / 19200 / 38400 / 57600 bps
Data Length (bit)	7 bit	7 / 8 bit
Parity Bit	Even	Even / Odd / None
Stop Bit (bit)	2 bit	1 / 2 bit

2.2.2 Reader Configuration

In some cases, the application software may provide support for reader configuration. If so, follow the instructions provided with the application.

The following procedure describes how to configure the reader directly from a PC using the browser-based interface.

The reader is with a static IP address which is default setting '192.168.1.200'. At first you can connect to the reader using the default IP address and change IP address to adjust it to your network environment.

Default network setting:

IP Address: 192.168.1.200
Subnet Mask: 255.255.255.0
Gateway: 192.168.1.254

If you are not using DHCP, you must know the IP address and subnet mask settings for the network environment in which the reader will be running. If you are using DHCP, you must have a means of finding the reader, typically by having a DHCP server update a DNS server.

How to change network settings is as the following:

- Exit any reader applications that are running on the network.
IMPORTANT: Running another reader application while using the browser-based interface may cause a reader error. If this happens, reboot the reader or restart the system using the browser-based interface.
- Verify that the reader is operational. All LED should be out except for 'PWR' and 'RUN' indicator which should be on.
- Start a **Java-enabled web browser** from any network-enabled PC. This PC must be configured with an IP address and subnet mask compatible with the reader's settings. For example:

IP address 192.168.1.100
 Subnet mask 255.255.255.0

- Browse to...

http://192.168.1.200

The V750 reader browser-based interface to the reader is displayed.



2.2.3 Web Browser Function

Via Web browser, you can set following functions, which can perform various works such as indicating an operation status or setting condition, or setting an operation parameter.

Web browser function in Operation Mode

Item	Function
Reader Status	Indicates current setting and operation status
Reader Settings	Specifies a parameter for communication with host.
Communication Settings	Specifies a parameter for communication with tag.
Operation Settings	Specifies a command entry and programmable output conditions.
Communication Test	Executes a communication commands.
Utility	Provides some functions for easy installation and maintenance. - Latest Error Logging (The function to display the latest error log) - History of Error Logging (The function to display the counted error log) - Noise Check (The function to monitor an on-site environment)
Firmware Update	Provides the method to update.

Web browser function in Safe Mode

Item	Function
Reader Status	Indicates current setting and operation status
Firmware Update	Provides the method to update.

* This mode provides required functions to recover from the error related with reader. Consistent static IP address: 192.168.1.200 and port: 7090.

2.3 Functions

2.3.1 Command Execution

Receiving a command from the host via Ethernet or RS-232C, the reader starts the command execution. You can use following three kinds of command.

- (1) Communication command
It triggers to communicate with tag.
It executes communication with tag according to the command option or the reader setting conditions.
- (2) Reader control command
It reads or changes operation control or setting of the reader.
- (3) Maintenance command
The command is used to test communication between host and the reader and to evaluate on-site environment such as noise check.

2.3.2 Digital Input / Output

(1) Digital input

Following two functions can be assigned to 4 digital inputs respectively. To assign the function, set via Set Operation window of command or Web.

- User Input: reads ON/OFF state by receiving the command from the host.
Command entry: executes registered command series at the rising edge of input signal.

(2) Digital output "Programmable output"

Following three functions can be assigned to 4 digital outputs respectively. To assign the function, set via Set Operation window of command or Web.

- User output: outputs ON/OFF state according to the command from the host.
Reader state output: outputs operation status of the reader.
Communication results output: outputs ON/OFF signal depending on the specified judgment after communication process.

2.3.3 Self-Operation

This function enables the reader to start some works, judge, and output the results without instruction of host by combining followings; registering command, setting reader status output, and setting communication result judgment.

(1) Command entry

Commands can be registered in Startup and 4 digital inputs respectively.

Available conditions

Executing timing	Entered command
Reader: Startup Power up or TCP/IP connection	Any given command
The rising edge of input #1 signal.	Any given command
The rising edge of input #2 signal.	Any given command
The rising edge of input #3 signal.	Any given command
The rising edge of input #4 signal.	Any given command

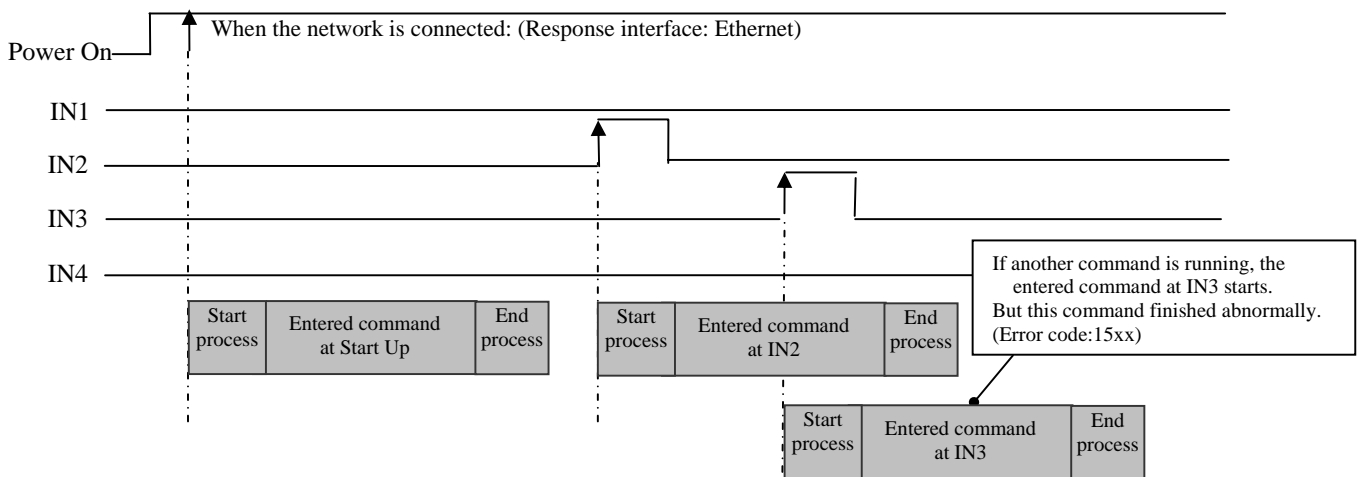

WARNING: DO NOT enter the reset command at executing timing of start up.

- (2) Reader status output
Data is output depending on the reader status.

Available conditions

Function	Output timing	Note
RUN	Running Normally	Same action as RUN LED (except for blink).
ERR	Abnormally stopped	Same action as ERR LED (except for blink).
COM	Communication status	Same action as OR of AT1-4 LED.
ATn (n:1 to 4)	Antenna "n" is specified.	Same action as LED of AT1, AT2, AT3, and AT4.

- (3) Communication result judgment
Upon the response for communication process is returned, the reader sends judgment signal depending on the specified conditions to the corresponding Digital output port (1-4). This function provides two judgment and output time for each output port.

Available conditions

Function	Output timing	Condition setting	Option
NORMAL	The process is finished normally.	-The read/written tag count: Operator (>=, <=, ==, !=) Compared number -Data comparison: Operator (==, !=) Compared data	Output duration
ERROR	The process is finished abnormally.	Error code	Output duration

2.3.4 Firmware Update

You can update the firmware by specifying update files via Web browser. Updated data shall be effective upon subsequent power-ups.

2.4 Communication

2.4.1 Communication Process

Combining following communication command and options, suitable communication procedures can be specified for your application.

Commands and Options

Item	Specifications	Note
Communication command	ID read	Reads tag's ID.
	ID write	Writes ID into the tag.
	Data read	Reads tag data (including password).
	Data write	Writes data (including password) into the tag.
	Lock	Enables lock function in the tag.
	Kill	Disables tag permanently.
Communication sequence (Option)	Single Once	Reads a single tag once for a specified period.
	Single Repeat	Reads a single tag once and repeats the transaction until termination has been instructed.
	Multi Once	Reads multiple tags once for a specified period.
	Multi Repeat	Reads multiple tags and repeats the transaction until termination has been instructed.
Antenna sequence (Option)	Antenna port number	1 / 2 / 3 / 4
	Antenna sequence number	Sets maximum 9 antennas sequence.
Communication parameter (Setting)	GEN2 Session value	S0 / S1 / S2 / S3
	Power level	Set each antenna port separately.
	Communication mode	Normal mode / Dense reader mode (DRM)
Filtering function	Filtering condition	
Smoothing function	Prevention of response duplication	
	Prevention of reread	
	Omission of no tag response	

2.4.2 Communication Sequence

As a way to communicate to the tag(s), you can choose a sequence among the following four sequences by specifying with the communication command.

Communication sequence

Name	Description
Single Access Mode	This method is used for communicating with a single tag in the communication field. It can communicate faster than the Multi access mode. This is suitable for the place where the reader communicates a single tag at a time and the place which requires speed and prompt control such as production process lines.
Single Once	This is used for communicating with a single tag in the communication field. Just after the communication transaction, the result is returned promptly.
Single Repeat	This is used for communicating with a single tag in the communication field. Just after the communication transaction, the result is returned promptly. Following the return, the reader carries out the transaction repeatedly with other tags.
Multi Access Mode	This method is used for communicating with one or more tag(s) in the communication field. It is suitable for the place where the reader communicates various numbers of tags existing in the communication field such as logistics distribution area.
Multi Once	This is used for communicating with multiple tags in the communication field. At the end of the specified period, the results are returned.
Multi Repeat	This is used for communicating with multiple tags in the communication field. At the end of the specified period, the results are returned. Following the return, the reader carries out the transaction repeatedly with other tags.

< Operation timing of communication sequence >

(1) Single Once

The reader reads a single tag at a time (One-to-one communication). When the reader detects the first tag, it returns response and terminates transaction (one response/ one transaction). If the reader does not detect any tag, it continues the process for a specified period of time. In this case, the response indicates "0" as the number of tags. If the period is not specified, it continues the process until the termination command has been sent or until it detects a tag.

< A sequence when the reader detects one tag for the specified period.>

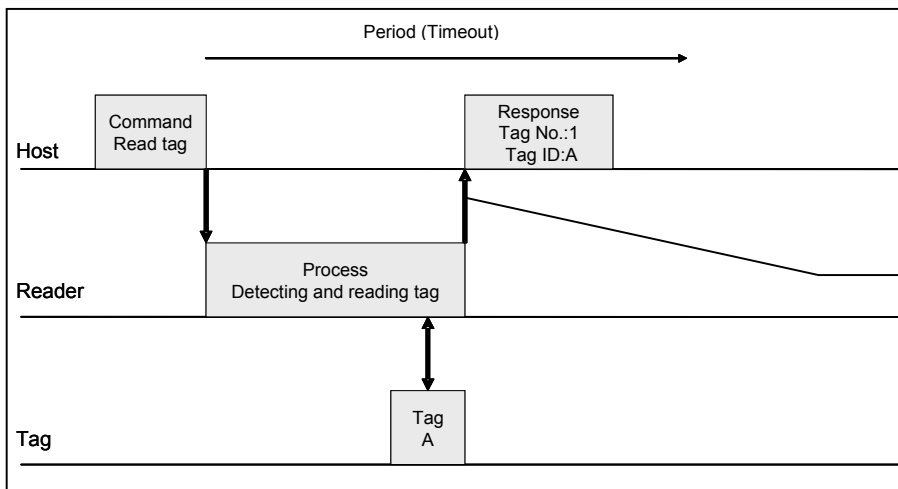

Just after the reader communicates the tag, it returns a response (reporting the read tag data) to the host.

< A sequence when the reader does not detect any tag for the specified period (There is no tag).>

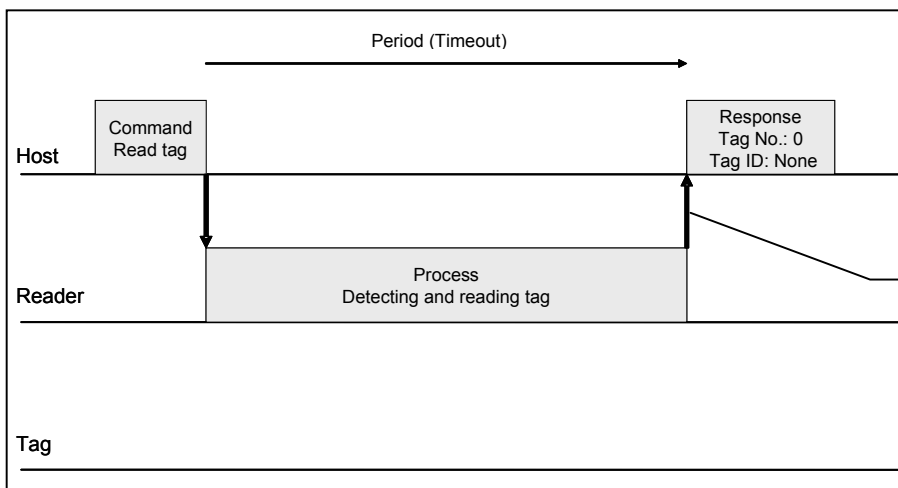

At the end of the specified period, the reader returns a response (reporting "no tag") to the host.

< A sequence when the period is not specified and the reader detects a single tag.>

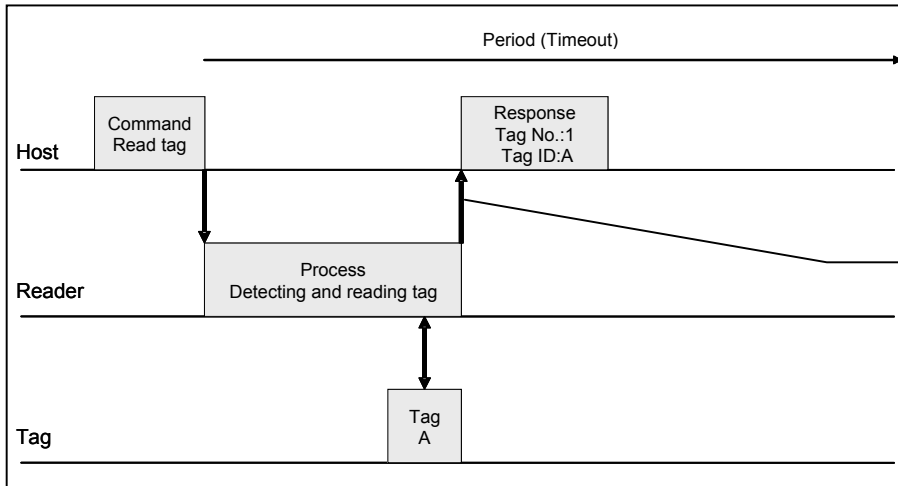

Just after the reader communicates the tag, it returns a response (reporting the read tag data) to the host.

< A sequence when the period is not specified and the reader does not detect any tag. (There is no tag)>

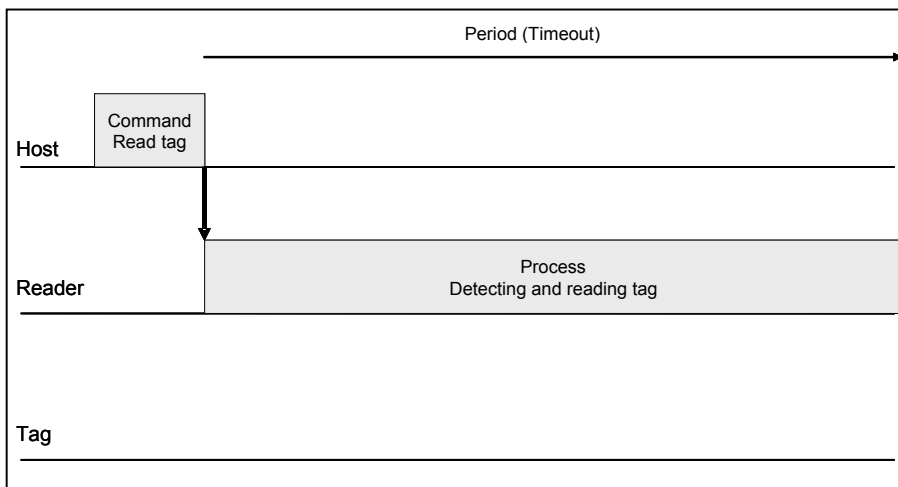

The reader does not return a response to the host until it detects any tag.

2) Single Repeat

The reader communicates with a single tag at a time (one-to-one communication) and repeats the communication transaction. When the reader detects the first tag, it returns response to the host, then it begins the next transaction repeatedly. Whenever it detects an unread tag, it reads the tag and returns read results to the host. It repeats the transaction until the termination command has been sent.

< A sequence when the reader detects tags one by one as it repeats the transaction.>

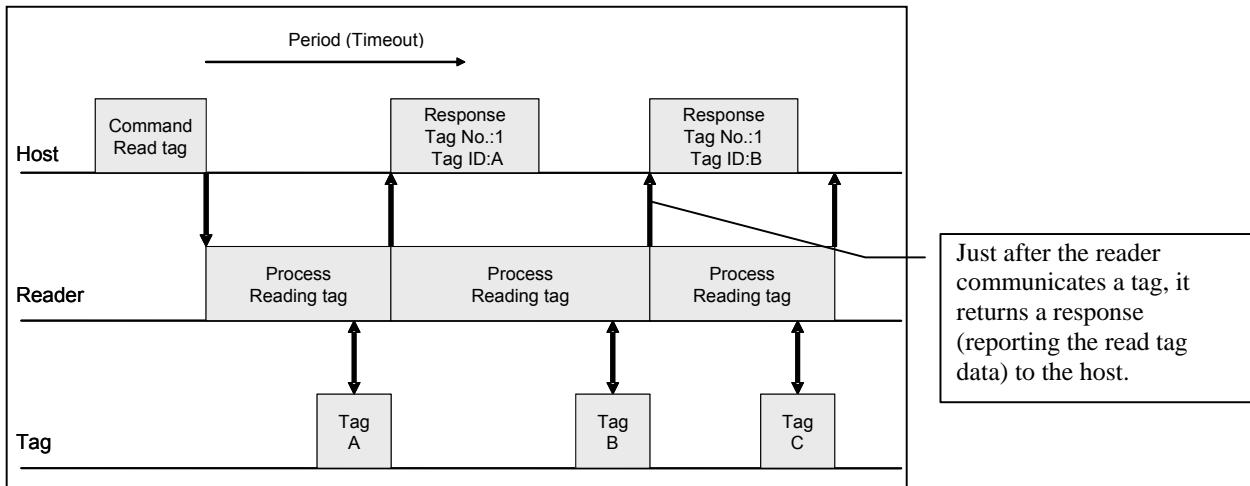

< A sequence when the reader carries out the transaction repeatedly and there is no tag. >

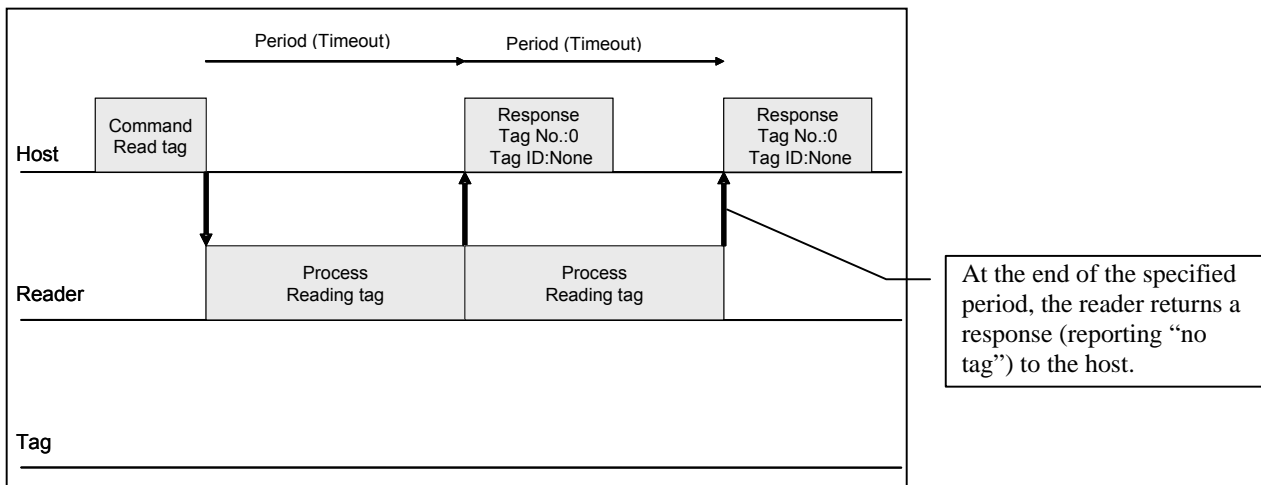

3) Multi Once

The reader reads multiple tags for a specified period. At the end of the specified period, it returns read results and finishes the transaction. If the reader does not detect any tag during the specified period, it returns a response meaning there is no tag.

< A sequence when the reader detects tags for the specified period.>

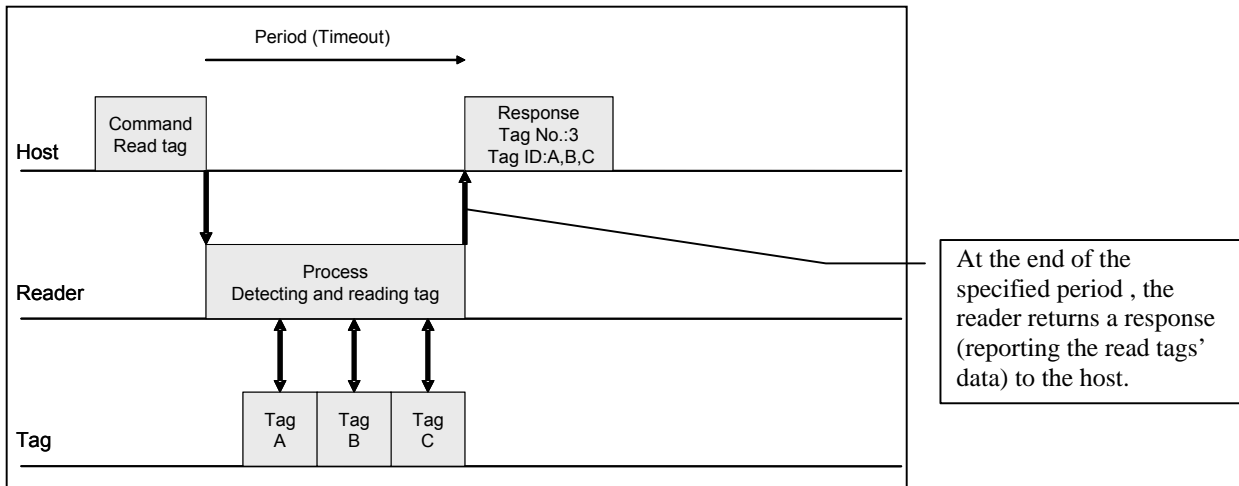

< A sequence when the reader carries out the transaction and there is no tag. >

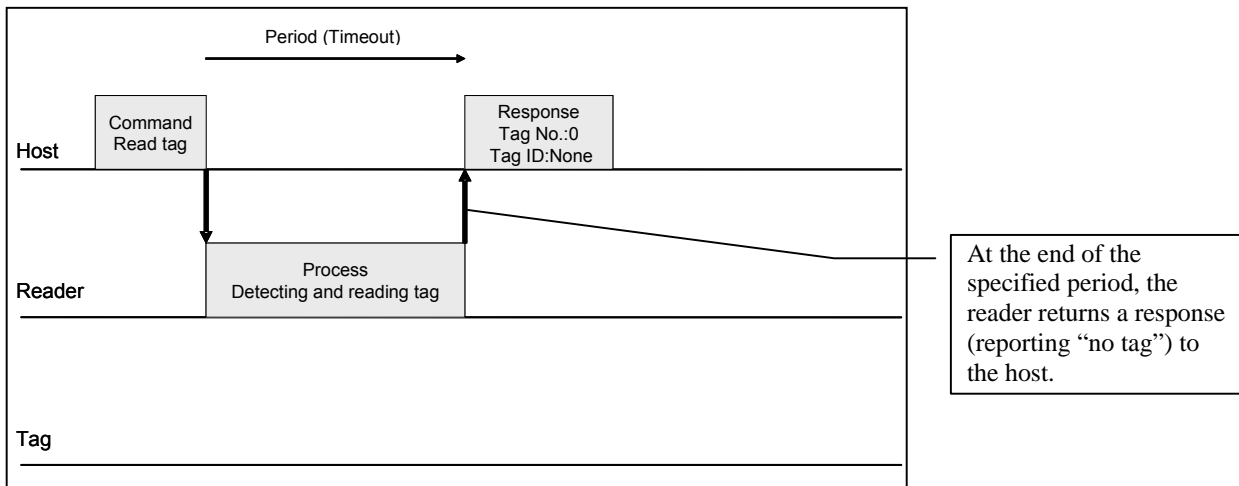

4) Multi Repeat

The reader reads multiple tags for a specified period. At the end of the specified period, it returns read results to the host and then it begins the next transaction until termination command has been sent. At each period, the reader returns all read tag's results to the host. If it does not read any tag during each time period, it returns response meaning there is no tag.

< A sequence when the reader detects tags repeatedly.>

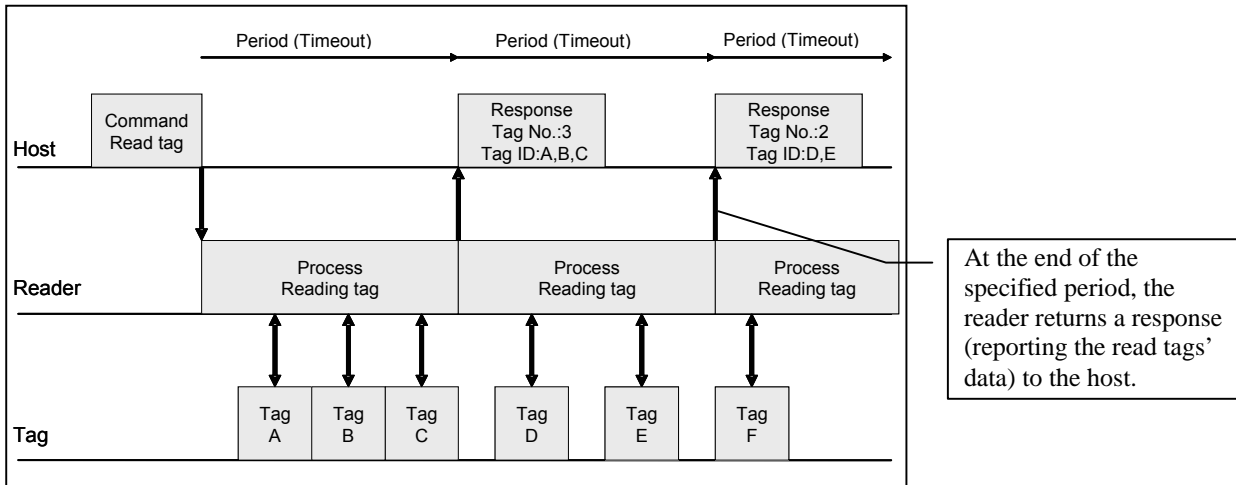

< A sequence when the reader carries out the transaction repeatedly and there is no tag. >

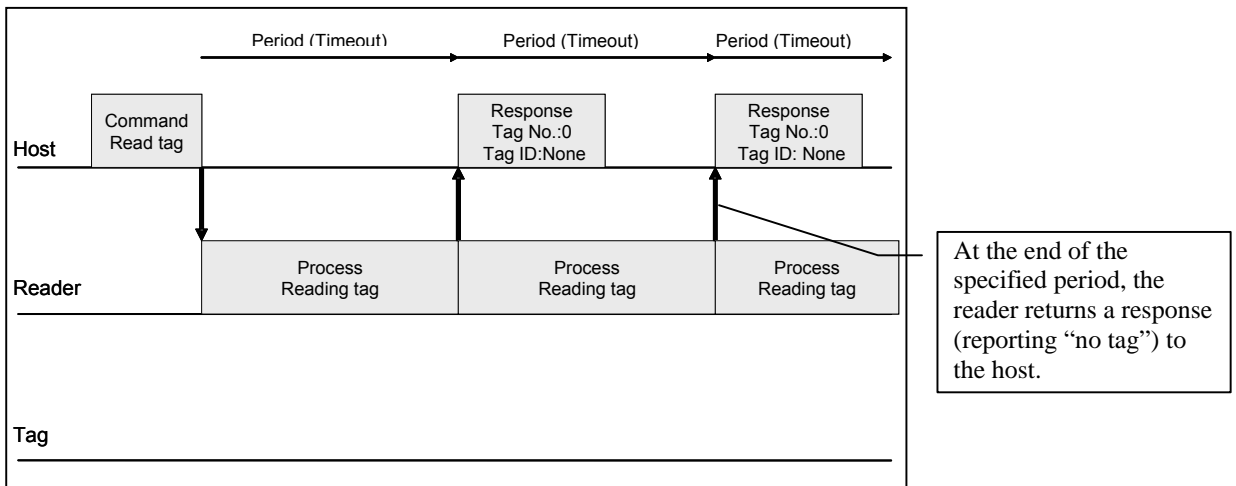

2.4.3 Antenna Sequence

The reader can be specified 9 antennas or less in one sequence. The reader searches tags with antenna in the order of specified. The sequence of antennas is described for once sequence and repeat sequence. The actual antenna sequence, when antenna is specified in order of "4, 3, 2, 1", is the following.

1) Once Sequence

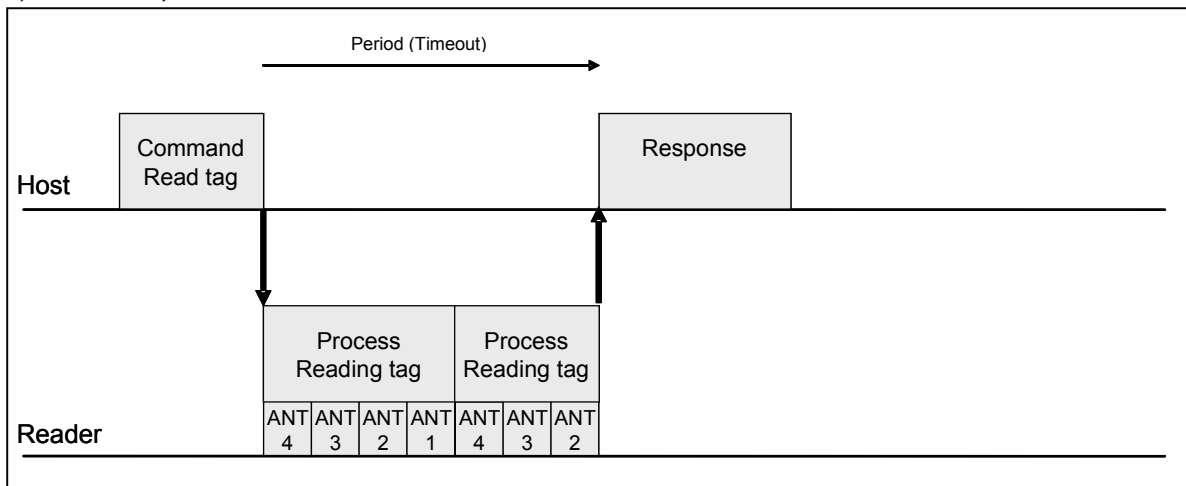

2) Repeat Sequence

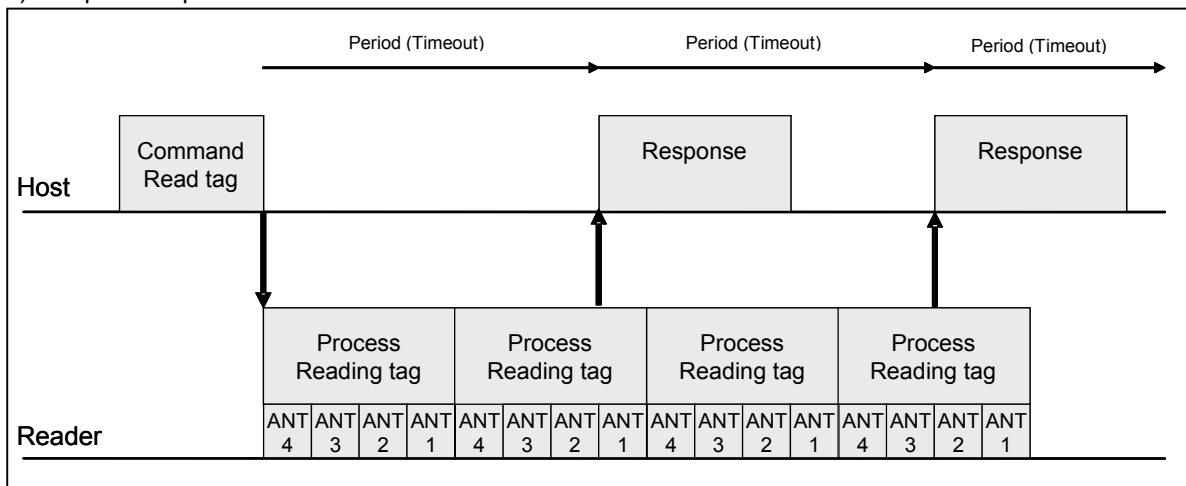

2.4.4 Session Setting

Following table shows 4 flags as a session flag for communication command. S0 is set as factory default setting for Once Access Mode command, and S2 is set for Repeat Access Mode command.

Session Setting

Communication option	Flag	Description
Once Access Mode - Single Once - Multi Once	S0	Factory default setting. In this setting, the reader communicates with all tags existing in the communication field whenever a command is executed.
	S1/S2/S3	In this setting, the reader communicates with un-read tags (it ignores once-read tags.) If S1 is set, tag refreshes its S1 flag when a specified time has passed after flag setting (after communication transaction) regardless of whether tag energized or not. It means that the tags are read repeatedly in a certain interval. If S2 or S3 is set, tag refreshes its S2 or S3 flag when a specified time has passed after tag energizing stopped. It means that the tag is not re-read unless the tag stays out of the communication field for the specified time.
Repeat Access Mode - Single Repeat - Multi Repeat	S2	Factory default setting. In this setting, the reader communicates with new-detected tags existing in the communication field during the command execution.
	S0	When there is a tag the reader can not read because of flag conflict with other readers, this setting enables the reader to read the tag.
	S1/S3	If another reader set in the previous process line uses S2 flag, the reader same flag may encounter the flag conflict. S1 and S3 flags are used to avoid this conflict. Setting S3 provides same operation as S2 setting. If S1 is set, tag refreshes its S1 flag when a specified time has passed after flag setting (after communication transaction) regardless of whether tag energized or not. It means that the tags are read repeatedly in a certain interval.

Effect of each session flag

Flag	Tag persistence time after tag energizing is stopped
S0	None
S1	500ms to 5000ms (Same when tag is energized)
S2/S3	2000ms or more

2.4.5 Communication Data Control

(1) Filtering function

Filtering function enables the reader to communicate with selected tags that are suitable for pre-specified conditions. Two filtering conditions can be registered as the pair of comparing area (Bank, Address, Length [bit]) and data value. And the reader uses filtering condition as 1st only, 2nd only, 1st and 2nd, 1st or 2nd condition.

<Application examples>

- To read pallet level tag selectively when item level tags and pallet level tag are existing together.
- To read only the selected vender's tag if there are various kind of venders' tags.
- To read the tags that has exclusive data format (the number of PC+EPC bit, NSI).
- To selectively read the specified tags that have certain supplier's IC.

(2) Smoothing function

Smoothing function consists of following three types. Using this function, the reader can reduce the data transferred between the host and the reader.

- 1) Prevention of response duplication
The reader can prevent duplicated responses of same tag ID in a one response.
- 2) Prevention of reread
Under this function setting, the tag that has been already read does not reply in the transaction period during the communication sequence (Repeat Access Mode: Single Repeat, Multi Repeat) which repeats its transaction,
- 3) Omission of no tag response
Under this function setting, the reader omits the responses if it does not read any tag in the communication sequence (Repeat Access Mode: Single Repeat, Multi Repeat) which repeats its transaction.

2.5 Tag Fundamentals

Tag Memory Structure

Protocols and the tag memory structures supported by the V750 reader are described below. For additional information regarding tag operation, refer to each tag specification.

GEN2 Tags

GEN2 tags have four memory banks.

Kill Password and Access Password are stored in bank 00 (Reserved Area), EPC code is in bank 01 (EPC Area), Tag Identification Memory data that is read only is in bank 10 (TID Area). User data is in bank 11 (User Area). For the detailed information refer each tag's specification.

<i>Bank</i>	<i>block number</i>	<i>Bit</i>	<i>Contents</i>
0 (00) [Reserved Area]	0	00-0F	Kill Password [31:16]
	1	10-1F	Kill Password [15:0]
	2	20-2F	Access Password [31:16]
	3	30-3F	Access Password [15:0]

1 (01) [EPC Area]	0	00-0F	CRC-16
	1	10-1F	Protocol-Control Bits (PC)
	2	20-2F	EPC[95:80]
	3	30-3F	EPC[79:64]
	4	40-4F	EPC[63:48]
	5	50-5F	EPC[47:32]
	6	60-6F	EPC[31:16]
	7	70-7F	EPC[15:0]
...	
2 (10) [TID Area]	0	00-0F	Tag Identification Memory data (read only)
	1	10-1F	

3 (11) [User Area]	0	00-0F	User data
	1	10-1F	
	2	20-2F	

3. Command Line Interface

About this Guide

This chapter lays the groundwork for the communication protocol between client software running on a remote host and the V750 reader.

3.1 Command Interface

3.1.1 Command / Response Frame Structure

Ethernet and RS-232C has almost the same command structure for command line I/F. Command frame has a Command Code area to control the R/W and Command Data area that is used with Command Code. Terminator that indicates the end of the frame is [LF].

RS-232C requires a start code [SOH], check data, and [CR] additionally. The start code shall be at the beginning of the frame, and the check data and the [CR] shall be just forward terminator [LF].

Command frame for Ethernet

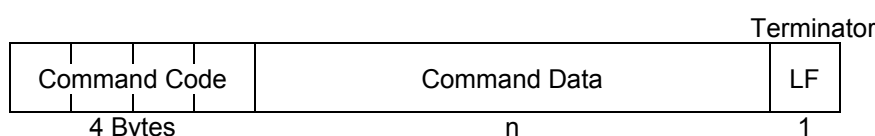

Command frame for RS-232C

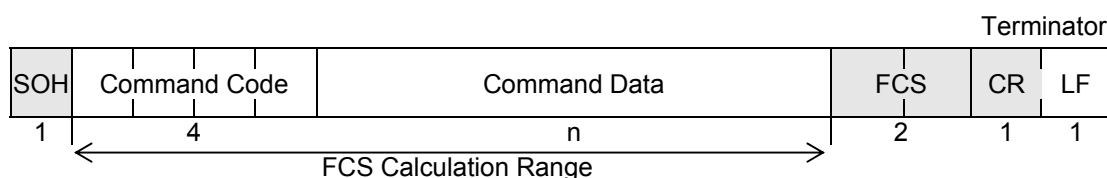

Contents in command frame

Contents	Description	Ethernet required	RS-232C required
Start Code [SOH=0x01]	Indicates the beginning of the frame with SOH.	No	Yes
Command Code	Specifies the command the reader executes.	Yes	Yes
Command Data	Specifies the data for use with Command Code	Yes	Yes
FCS	Stands for Frame Check Sequence (hereinafter referred to as "FCS". The code is to detect an FCS error.) The result of the horizontal parity calculation from after SOH through just before the FCS is expressed by two characters of ASCII code.	No	Yes
Terminator [CR=0x0d]	Indicates the end of the frame with CR.	No	Yes
Terminator [LF=0x0a]	Indicates the end of the frame with LF.	Yes	Yes

Response frame for Ethernet

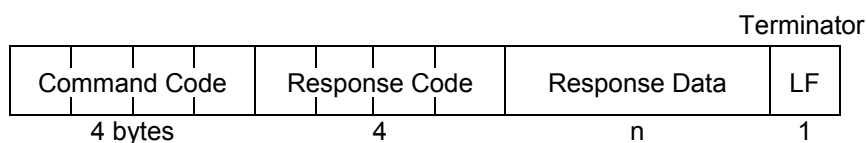

Response frame for RS-232C

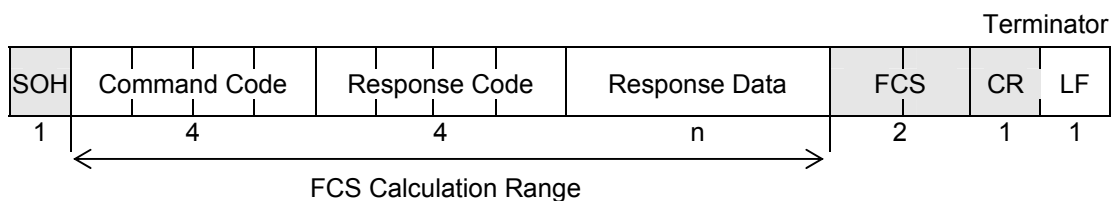

Contents in response frame

Contents	Description	Ethernet required	RS-232C required
Start Code [SOH=0x01]	Indicates the beginning of the frame with SOH.	No	Yes
Command Code	Specifies the command the reader executes.	Yes	Yes
Response Code	Indicates the result code of command execution.	Yes	Yes
Response Data	Indicates the result data of command execution.	Yes	Yes
FCS	Stands for Frame Check Sequence	No	Yes
Terminator [CR=0x0d]	Indicates the end of the frame with CR.	No	Yes
Terminator [LF=0x0a]	Indicates the end of the frame with LF.	Yes	Yes

How to calculate FCS in frame for RS-232C.

Calculate XOR (Exclusive OR) of figures included in the range of FCS calculation and put the result as a ASCII code at the end of the command.

An example of FCS calculation:

Command code and Command data: RDID -seq MOC -ant 1 -tmo 500

FCS value: 19

Command frame: [SOH]RDID -seq MOC -ant 1 -tmo 50019[CR][LF]

Calculation

Character	ASCII Code (Hex)	Binary
R	52	01010010
D	44	01000100
I	49	01001001
D	44	01000100
(Space)	20	00100000
-	2C	00101100
s	73	01110011
e	65	01100101
q	71	01110001
(Space)	20	00100000
M	4C	01001100
O	4F	01001111
C	43	01000011
(Space)	20	00100000
-	2C	00101100
a	61	01100001
n	6E	01101110
t	74	01110100
(Space)	20	00100000
l	31	00110001
(Space)	20	00100000
-	2C	00101100
t	74	01110100
m	6C	01101100
o	6F	01101111
(Space)	20	00100000
5	35	00110101
0	30	00110000
0	30	00110000
XOR	19	00011001

3.1.2 Command Code List

Following is a list of the supported command codes. Each command is represented with four characters.

Command Code List

Command Code	Command Name	Description	Executable in communication
(1) Communication Command (to communicate with tags)			
RDID	<u>Read ID</u>	Reads ID data from the tag memory.	No
WTID	<u>Write ID</u>	Writes ID data into the tag memory.	No
RDDT	<u>Read Data</u>	Reads data from the tag memory (including passwords).	No
WTDT	<u>Write Data</u>	Writes data to the tag memory (including passwords).	No
LOCK	<u>Lock</u>	Sets Lock function in the tag.	No
KILL	<u>Kill</u>	Disables the tag permanently.	No
(2) Setting Command (to set a condition).			
SETR	<u>Set Reader</u>	Sets the function settings in the reader.	No
GETR	<u>Get Reader</u>	Reads the function settings from the reader.	No
SETC	<u>Set Communication</u>	Sets the communication settings in the reader (temporary setting).	No
GETC	<u>Get Communication</u>	Reads the communication settings from the reader.	No
SETO	<u>Set Reader Operation</u>	Sets the operation settings in the reader.	No
GETO	<u>Get Reader Operation</u>	Reads the operation settings from reader.	No
SAVE	<u>Save communication settings</u>	Save the communication condition into the nonvolatile memories in the reader (permanent setting).	No
(3) Control command (to control the action)			
INIT	<u>Initialize</u>	Initializes all settings in the reader.	No
STOP	<u>Stop</u>	Stops the communication with the tags.	Yes
EXIO	<u>External Input Output control</u>	Reads input/output port status. Sets condition of output port.	Yes
REST	<u>Reset</u>	Restarts the reader.	Yes
GBYE	<u>Good Bye</u>	Disconnects the Ethernet connection.	No
RRES	<u>Request Resend</u>	Requests to resend the last response data.	Yes
TEST	<u>Test System</u>	Tests the communication between host and the reader. Reads the operation status from reader.	Yes
NOIS	<u>Noise monitoring</u>	Monitors noise level of the specified antenna.	No
(4) Undefined command (in the response frame only)			
ICMD	<u>Illegal Command</u>	Command code to be used in the response frame if the R/W receives undefined command.	-

3.1.3 Response Code List

Response code consisting of four digit figures represents the result of the command execution. Response code helps you to speculate a cause of the occurred error.

Response Code List

Category	Response Code		Response Name	Description	
	Main	Sub			
Normal end	00	00	Normal end	The received command ended normally with no error.	
Command error	10	00	Parity error	A parity error has occurred in one of the characters of the command frame (For only RS-232C).	
	11	00	Framing error	A framing error has occurred in one of the characters of the command frame (For only RS-232C).	
	12	00	Overrun error	An overrun error has occurred in one of the characters of the command frame (For only RS-232C).	
	13	00	FCS error	The command frame has an incorrect FCS (Only for RS-232C).	
	14	0x	Command code error	Incorrect command has been received. The response code is ICMD.	
			1x	Command parameter error	Command parameter is incorrect.
			2x	Command option error	Command option is incorrect.
	15	0x	Process error	Specified command can not be executed. Ex. Caused by executing a communication command when the last command is being executed Ex. Caused by incorrect setting of filtering condition.	
			1x	Filter error	Specified filter settings is incorrect. Ex. Caused by incorrect setting of filtering condition.
18	00	Frame length error	A command received from the host exceeds the receive buffer (512 Bytes).		

Category	Response Code		Response Name	Description
	Main	Sub		
Tag communication error	70	1x	Communication error	During the transaction after tag detection, communication error or process time out has occurred, and consequently the transaction can not be completed normally. Specified password does not match to the one of the target tag.
		2x	Communication error	During the transaction after tag detection, communication error or process time out has occurred, and consequently the transaction can not be completed normally. * In the case of ID write / Data write, a part of data in the tag may have been written.
	71	00	Verification error	The reader has not written the data to the tag by reason of verification error.
	7A	00	Address specification error	Specifying Bank/Address in the tag memory is incorrect and command can not be executed.
	7B	00	Data write error	During the data write into the detected tag, sufficient power is not supplied to the tag.
	7C	1x	Antenna detection error	At the R/W starts up, an appropriate antenna has not been connected to the specified antenna port.
		2x	Antenna error	Error occurred with the antenna connected to the specified antenna port (even though the antenna is detected normally when start up).
	7E	00	Lock error	When data write or read command is sent for the locked area. It depends on the tag's chip specifications. (For Monza chip, when these commands are sent for Lock Bit of User Memory because this area does not exist.)
	7F	xx	Tag error	The tag has been rejected the command process.
System error	9A	xx	System error	An error that blocks command execution has been detected in the hardware (such as malfunction of inner circuit or temporary execution error caused by noise).

'x' character in response code means one character in the list of 0 to 9 or A to F.

3.1.4 Command / Response Format

Following shows syntax of command.

Command Code and Command Data format in Command Frame

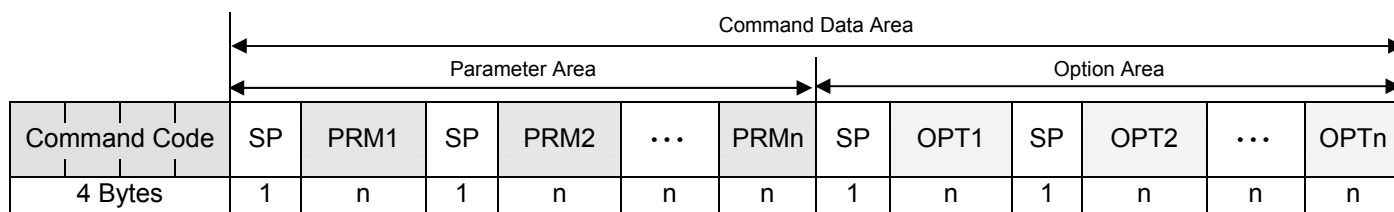

Command Code	Consists of four characters in ASCII format. This specifies one of the commands described in the Command Code List of 3.1.2.
Space (SP)	Between the elements (Parameters and Options), " " (space) has to be entered for one or more character. Even if a two or more characters of " " (space) are put in, they work same way as one-character " " (space).
Parameter (PRMx x:1 to n)	Mandatory for each command. If there are multiple parameters in a single command, they must be separated with some spaces and specified in the specified order. Applicable parameter for each command is shown in the table in 3.1.5.1.
Option (OPTx x:1 to n)	Optional for each command. If there are multiple options in a single command, they must be separated with some spaces. If it is not specified, default value will be employed. If multiple option items are specified, they shall be described continuously. Any order is acceptable.

* Commands are acceptable regardless of whether upper or lower case letters are used. Any command works regardless the size combination of characters such as upper case letters, lower case letters, or mixed one.

Command Code, Response Code and Response Data format in Response Frame

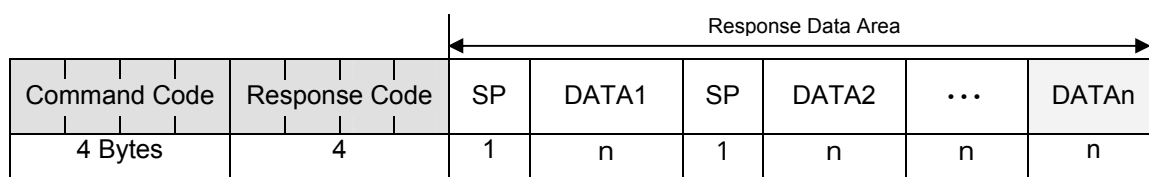

Command Code	Set same characters specified as a command sent from the host.
Response Code	Indicates four-digit hexadecimal numbers by ASCII format.
Response Data (DATAx x:1 to n)	Returns some data executed by the reader. Example1: Number. of tags for communication commands Example2: The tag ID(s) (or data) read by the reader with Hex code. If the reader reads multiple tags' IDs (or data), it indicates them in line with space(s) between each ID (or data). Data in hexadecimal numbers does not have [0x].

* All hexadecimal numbers as commands and data in the read tags are indicated with upper case letters (A to F).

3.1.5 Command Specification

3.1.5.1 Communication Command

A communication command consists of parameter(s) mandated for command execution and option specified if necessary. Following table shows parameters of each command and available options.

Parameters and Options for Communication Commands

Command Data		Parameters (mandatory)					Options					
		Memory Bank	Data Pointer	Data Length	Write Data	Lock Code	Sequence [-seq]	Antenna ID. [-ant]	Timeout [-tmo]	Tag Info. [-tif]	Password [-pwd]	Tag Protocol [-ptc]
Command Code												
Read ID	RDID						Yes	Yes	Yes	Yes		Yes
Write ID	WTID				Yes		Yes	Yes	Yes	Yes	Yes	Yes
Read Data	RDDT	Yes	Yes	Yes			Yes	Yes	Yes	Yes	Yes	Yes
Write Data	WTDT	Yes	Yes		Yes		Yes	Yes	Yes	Yes	Yes	Yes
Lock	LOCK					Yes	Yes	Yes	Yes	Yes	Yes	Yes
Kill	KILL						Yes	Yes	Yes	Yes	Yes	Yes

- All options can be omitted. If option(s) is omitted, the default value is applied depending on the option item.
- Kill command requires the option item “-pwd” (if the “-pwd” is not used in command, 7Fxx error will occur.)

To set parameters, items in the following list shall be chosen and be described in to the command one's way down the list.

Parameter Details

Parameter	Setting value
Memory Bank	Memory bank of a GEN2 tag for "Read Data" or "Write Data" shall be specified with the following number in decimal format. - 0: Reserved Area - 1: EPC Area - 2: TID Area - 3: User Area
Data Pointer	Memory address in the memory bank of the GEN2 tag for "Read Data" or "Write Data" shall be specified with number(s) in the following range in decimal format. - Min: 0 - Max: 255
Data Length	Memory size to be accessed for "Read Data" shall be specified with the word number(s) in the following range in decimal format. - Min: 1 - Max: 32 -Note: One word length is 16bits.
Write Data	To write data into a tag with "Write ID" or "Write Data" command, the data shall be specified in 32-bit hexadecimal format as below. (0x not required) - Format: XXXXXXXX ... XXXXXXXX X: 0 to 9 , A to F Ex. 12345678
Lock Code	When Lock command is executed, this code shall be specified depending on the type of lock. For GEN2, 10-digit Lock value shall be specified with 0, 1 or * (0 and 1 mean Action and * means MASK) for following five areas; Kill pwd, Access pwd, EPC memory, TID memory, and User memory. • Format: XXXXXXXXXXXX X: 0 , 1 or * (0:Off , 1:On , *:Don't care)

chr.	1	2	3	4	5	6	7	8	9	10
	Kill pwd		Access pwd		EPC memory		TID memory		User memory	
Action Fields	pwd read/write	perma lock	pwd read/write	perma lock	pwd write	perma lock	pwd write	perma lock	pwd write	perma lock

Option shall be specified with values following the code that indicates option type.

Option Details

Code	Item	Specified Value	Default Value
-seq	Communication <u>sequence</u>	Specifies the communication sequence according to the operating conditions. For only "Read ID" command, all parameters can be specified. For other commands, only SOC can be specified. <ul style="list-style-type: none"> - SOC: Single Once - SRP: Single Repeat - MOC: Multi Once - MRP: Multi Repeat 	-seq SOC
-ant	<u>Antenna ID</u>	Can specify the order of antenna to operate from 1 st to 9 th with figure of 1, 2, 3 and 4. The figure 1 to 4 means antenna's identical number. If an antenna is specified multiply, the antenna executes sequence multiply depend on the order. <ul style="list-style-type: none"> - Format: X ... XXXXXXXXX (Max 9 characters) X: 1 to 4 	-ant 1
-tmo	<u>Timeout</u>	Specifies time parameter for communication process with 0 to 2500 in decimal number. The numbers after rounding down to the 10 is added milliseconds as a specified value (the least significant digit is always "0"). If the communication sequence is SOC, the specified value is the communication time. If the value is specified 0 (zero), communication process will continue until STOP command is executed. If the communication sequence is SRP/MOC/MRP, the specified value is maximum time between response (0 can't be specified on SRP/MOC/MRP sequence). (When you determine the value of Timeout, see the section 5.2 "Communication Time".) <ul style="list-style-type: none"> - Min: 0 (ms) - Max: 2500 (ms) - Step: 10 (ms) 	-tmo 250
-tif	<u>Tag Information</u>	Specifies one or more items as additional information of tag communication results that are output in the response. Specified item(s) shall be returned according to the specified order with commas. <ul style="list-style-type: none"> - ANT: An antenna number which reads the tag first. - CNT: The count of tag read. - EPC: EPC code only. - PEP: PC bits and EPC code - PER: PC bits, EPC code, and CRC For ID read, EPC/PRP/PER determines the EPC data type to be returned. For ID write or Data write, if EPC/PEP/PER is specified, EPC data before rewriting shall be returned. (If EPC data length is 0, it will be "*".)	-tif EPC
-pwd	<u>Password</u>	Specifies the password data with 32-bit, 8 digit numbers in hexadecimal format for access of ID Write command, Data Read command, Data Write command, and Lock command, and Kill password for Kill command. (0x not required) <ul style="list-style-type: none"> - XXXXXXXX For ID Write, Data Write, or Lock, if this option is omitted or specified "00000000", Access password shall not be used. (If Access password of the Tag is 0x00000000, the tag can be processed. For Kill command, the Access password shall not be 0x00000000. If so, 7Fxx error occurs.)	-pwd 00000000
-ptc	<u>Tag Protocol</u>	Specifies the number(s) that indicates the protocol type. Multiple numbers can be specified. <ul style="list-style-type: none"> - 2: Class1 Generation2 	-ptc 2

[Note]

For setting a timeout value, 100ms or less shall not be specified under the repeat mode (SRP/ MRP). If so, the reader may freeze (setting error may occur) depending on the communication performance of the Ethernet or RS-232C. If Ethernet's traffic is large or the communication speed setting for RS-232C is low, the value shall be set longer.

(2) Write ID (WTID)

Command	WTID(S)WriteData(S)[Options...]<LF> WriteData: Data to be written in 4-digit hexadecimal number (Max: 128 characters).
Response	WTID[RC](S)[CNT](S)[ITM1]<LF> [RC]: Response Code [CNT]: Tag Count [ITM1]: Items indicated by TIF option. Items are delimited by a comma. Note: • If EPC/PEP/PER are specified for TIF, EPC data shall be the data before rewrite. If data length is zero during EPC specification, data shall become "*".

*(S) Space character

Example 1) When all option values are default values and ID 1234567890ABCDEF12345678 is specified, the command is executed and write process has been completed successfully:

```
[Tx] WTID 1234567890ABCDEF12345678<LF>
[Rx] WTID0000 001<LF>
```

Example 2) When ID "55555555555555555555555555555555" and EPC code are specified for write data and tag information, the command is executed and then the reader has succeeded.

```
[Tx] WTID 55555555555555555555555555555555 -tif EPC <LF>
[Rx] WTID0000 001 44444444444444444444444444444444<LF>
* If -tif is specified for EPC code, tag's EPC data before rewritten is returned. If the tag had an EPC data "44444444444444444444444444444444" as last ID, response is as above.
```

Example 3) When 1234567890ABCDEF12345678 and antenna are specified for write data and tag information, the command is executed and then the reader has succeeded to write data with antenna 1.

```
[Tx] WTID 1234567890ABCDEF12345678 -tif EPC,ANT<LF>
[Rx] WTID0000 001 *,1<LF>
* If the tag had no EPC data before, [*] is returned.
```

Example 4) When FFFFFFFFFFFFFFFFFFFFFFFFFF, 2, and 300 are specified for ID, antenna, timeout and the command is executed but no tag is found:

```
[Tx] WTID FFFFFFFFFFFFFFFFFFFFFFFFFF -ant 2 -tmo 300<LF>
[Rx] WTID0000 000<LF>
```

Example 5) When 123412341234123412341234 and ABCDABCD are specified for ID and access password is executed but access password is not matched:

```
[Tx] WTID 1234123412341234123412341234 -pwd ABCDABCD<LF>
[Rx] WTID0000 000<LF>
```

Example 6) When an error has occurred during communication process:

```
[Tx] WTID 1234567890ABCDEF12345678<LF>
[Rx] WTID7012<LF>
* The error code [Code:7012] is returned.
```

(3) Read Data (RDDT)

Command	RDDT(S)MemoryBank(S)DataPointer(S)DataLength(S)[options...]<LF> <i>MemoryBank</i> : Memory Bank <i>DataPointer</i> : Data Pointer <i>DataLength</i> : Data Length
Response	RDDT[RC](S)[CNT](S)[Data with ITM1]<LF> [RC]: Response Code [CNT]: Tag Count [Data with ITM]: Data with Items indicated by TIF option. Items are delimited by a comma.

*(S) Space Character

Example 1) When [Memory bank; 0, Start address(=Data pointer); 0, word count to be read(=Data length); 1] is specified, other settings are default value and then read process has completed successfully:

```
[Tx] RDDT 0 0 1<LF>
[Rx] RDDT0000 001 1234<LF>
```

Example 2) When [Memory bank; 1, Start address(=Data pointer); 0, word count to be read(=Data length); 8] is specified, other settings are default value and then read process has completed successfully:

```
[Tx] RDDT 1 0 4<LF>
[Rx] RDDT0000 001 BCAD300055555555<LF>
```

Example 3) When [Memory bank; 1, Start address(=Data pointer); 2, word count to be read(=Data length); 3, Antenna; 1 to 3, Tag information; EPC and antenna id] is specified and read process has succeeded:

```
[Tx] RDDT 1 2 3 -ant 123 -tif EPC,ANT<LF>
[Rx] RDDT0000 001 111122223333,1234567890ABCDEF12345678,2<LF>
* In this case, the read data is [111122223333], the tag EPC code is [1234567890ABCDEF12345678], and the read antenna ID is [2].
```

Example 4) When indicated address can not supported:

```
[Tx] RDDT 0 0 8<LF>
[Rx] RDDT0000 000<LF>
* No count data is returned.
```

Example 4) When an incorrect address[1000] is specified:

```
[Tx] RDDT 0 1000 1 -ant 123<LF>
[Rx] RDDT1412<LF>
* The command data error [Code:1412] is returned.
```

Example 5) When an error has occurred during communication process:

```
[Tx] RDDT 0 0 1 -ant 123<LF>
[Rx] RDDT7012<LF>
* The error code [Code:7012 (in this case)] is returned.
```

(4) Write Data (WTDT)

Command	<code>WTDT(S)MemoryBank(S)DataPointer(S)WriteData(S)[options...]<LF></code> <i>MemoryBank</i> : Memory Bank <i>DataPointer</i> : Data Pointer <i>WriteData</i> : Data to be written
Response	<code>WTDT[RC](S)[CNT](S)[ITM1]<LF></code> [RC]: Response Code [CNT]: Tag Count [ITM1]: Items indicated by TIF option. Items are delimited by a comma. Note: • If EPC/PEP/PER are specified for TIF option, EPC data shall be the data before rewrite. If data length is zero during EPC specification, data shall become "".

*(S) Space Character

Example 1) When [Memory bank; 0, Start address(=Data pointer); 0, Data; 0x1234 (one word)] is specified, other setting are default and then the write process has been succeeded:

```
[Tx] WTDT 0 0 1234<LF>
[Rx] WTDT0000 001<LF>
```

Example 2) When [Memory bank;1, Start address(=Data pointer); 3, Data; 0x1234567890ABCDEF12345678, Antenna; 2 and 3, Timeout; 200, Tag information; antenna id] is specified:

```
[Tx] WTDT 1 3 1234567890ABCDEF12345678 -ant 23 -tmo 200 -tif ANT<LF>
[Rx] WTDT0000 001 2<LF>
```

* In this case, the response code has an antenna ID which is used in writing process.

Example 3) When specified address is not supported:

```
[Tx] WTDT 1 8 12345678<LF>
[Rx] WTDT0000 000<LF>
```

* No count response is returned.

Example 4) When specified address is locked:

```
[Tx] WTDT 0 0 AAAAAAAAA<LF>
[Rx] WTDT0000 000<LF>
```

* No count response is returned.

Example 5) When [Memory bank; 1, Start address(=Data pointer); 2, Data; 0xABCDEFGH] is specified and a format error has occurred:

```
[Tx] WTDT 1 2 ABCDEFGH<LF>
[Rx] WTDT1412<LF>
```

* The error code [Code:1412] is returned.

Example 6) When an error occurred during communication process:

```
[Tx] WTDT 1 32 1234567890ABCDEF12345678 -ant 23<LF>
[Rx] WTDT7011<LF>
```

* The error code [Code:7011 (in this case)] is returned.

(5) LOCK (LOCK)

Command	LOCK(S)LockCode(S)[options...]<LF> LockCode: Lock Code (10 characters 0/1/*)
Response	LOCK[RC](S)[CNT](S)[ITM1]<LF> [RC]: Response Code [CNT]: Tag Count [ITM1]: Items indicated by TIF option. Items are delimited by a comma.

*(S) Space Character

Example 1) When [EPC memory; locked temporarily] is set:

```
[Tx] LOCK ****10****<LF>
[Rx] LOCK0000 001<LF>
```

Example 2) When [Access password and Kill password; locked temporarily] is set with password; 0xABCDABCD:

```
[Tx] LOCK 1010***** -pwd ABCDABCD<LF>
[Rx] LOCK0000 001<LF>
```

Example 3) When [Access password and Kill password; unlocked] is set with [password; 0xAAAAAAAA, tag information; EPC code and antenna:

```
[Tx] LOCK 0000***** -pwd AAAAAAAAA -tif EPC,ANT<LF>
[Rx] LOCK0000 001 77777777777777777777777777777777,1<LF>
```

Example 4) When [Password; 0xFFFFFFFF, all memories are locked permanently] is set:

```
[Tx] LOCK 1111111111 -pwd FFFFFFFF<LF>
[Rx] LOCK0000 001<LF>
* The EPC code of the tag is [1234567890ABCDEF12345678].
```

Example 5) When [Password; 0x12341234, all memories are locked permanently] is specified and specified password is incorrect:

```
[Tx] LOCK 1111111111 -pwd 12341234<LF>
[Rx] LOCK7011<LF>
* The communication error [Code:7011 (in this case)] is returned.
```

Example 6) When [Password; 0xAAAAAAAA, Lock code;22222222] is specified and specified lock code is incorrect:

```
[Tx] LOCK 2222222222 -pwd AAAAAAAAA<LF>
[Rx] LOCK1412<LF>
* The error code [Code:1412] is returned.
```

(6) Kill (KILL)

Command	KILL(S)[options...]<LF> Option "-pwd" is mandatory.
Response	KILL[RC](S)[CNT](S)[ITM1]<LF> [RC]: Response Code [CNT]: Tag Count [ITM1]: Items indicated by TIF option. Items are delimited by a comma.

*(S) Space Character

Example 1) When [Password; 0x22222222] is specified and then KILL command is completed normally:

```
[Tx] KILL -pwd 22222222<LF>
[Rx] KILL0000 001<LF>
```

Example 2) When [Password; 0xAAAABBBB, Antenna; 3, Tag information; PER and ANT] is specified and KILL command has completed normally:

```
[Tx] KILL -pwd AAAABBBB -ant 3 -tif PER,ANT<LF>
[Rx] KILL0000 001 30001234567890ABCDEF12345678ABCD,3<LF>
* The PC code of the tag is [3000], EPC code is [1234567890ABCDEF12345678], CRC is [ABCD],
and command executed Antenna ID is [3].
```

Example 3) When [Password; 0x12345678] is specified and password data has been incorrect:

```
[Tx] KILL -pwd 12345678<LF>
[Rx] KILL7012<LF>
* The error code [Code:7012] is returned.
```

Example 4) When [Password; 0x12] is specified and password length has been incorrect:

```
[Tx] KILL -pwd 12<LF>
[Rx] KILL1421<LF>
* The error code [Code:1421] is returned.
```

3.1.5.2 Reader Status, Reader Settings Function

To set the Reader Status and Reader Settings, following items shall be specified in the SET Reader command (SETR) and GET Reader command (GETR). The Reader Status is available only for reading data.

Reader Status [Static / Read only] (GETR)

Code	Content	Fixed Value (=Factory Settings)
MFT	Manufacturer	"OMRON Corporation"
TYP	Type of the reader	"V750-BA50C04-US"
FWV	Firmware version	xxx-xxx-xxx-x
SER	Serial number	"xxxxxxx"
MAC	MAC address	00:00:0A:89:xx:xx

Reader Status [Dynamic / Read only] (GETR)

Code	Content	Variable Value
ATS	Antenna status (Connected Antenna)	xxxxx (x:1 to 4) -ex1. All antennas are connected: 1234 -ex2. Antenna #1 and antenna #4 are connected: 14
TTK	Transition time from kick	hhhh:mm:ss -Min: 00:00:00 -Max: 9999:59:59

Reader Settings [Reader Information] (GETR/SETR)

Code	Content	User Setting Value	Factory Settings
RNM	Reader name	Given string -Min: 1 characters , ASCII -Max: 63 characters, ASCII -Note: This setting value has double quotation marks.	(None)
RRL	Reader's role	Given string -Min: 1 characters , ASCII -Max: 63 characters , ASCII -Note: This setting value has double quotation marks.	(None)

Reader Settings [Ethernet] (GETR/SETR)

Code	Content	User Setting Value	Factory Settings
LHN	<u>L</u> AN <u>h</u> ost <u>n</u> ame Sent to DHCP server when IP is acquired.	Given strings -Min: 1 character, ASCII -Max: 63 characters, ASCII -Note: This setting value has double quotation marks.	"V750-BA50C04-US"
LDN	<u>L</u> AN <u>d</u> omain <u>n</u> ame Sent to DHCP server when IP is acquired.	Given string -Min: 1 character, ASCII -Max: 67 characters, ASCII -Note: This setting value has double quotation marks.	(None)
DHE	<u>D</u> HCP <u>e</u> nable	Choice 0: Disable / 1: Enable	0: Disable
LIP	<u>L</u> AN <u>I</u> P address IP address when using static network settings	xxx.xxx.xxx.xxx	192.168.1.200
LNM	<u>L</u> AN <u>s</u> ubnet <u>m</u> ask Subnet mask when using static IP address	xxx.xxx.xxx.xxx	255.255.255.0
LGW	<u>L</u> AN default <u>g</u> ateway Default gateway when using static IP Address	xxx.xxx.xxx.xxx	192.168.1.254
PRT	Ethernet <u>P</u> ort 3 ports are used; specified port and specified port +1 and -1	Given value -Min: 1025 -Max: 65534	7090

Reader Settings [RS-232C] (GETR/SETR)

Code	Content	User Setting Value	Factory Settings
RBR	<u>R</u> S-232C <u>b</u> aud <u>r</u> ate (bps)	Choice 9600 / 19200 / 38400 / 57600	57600
RDT	<u>R</u> S-232C <u>d</u> ata <u>l</u> ength (bit)	Choice 7 / 8	7
RPB	<u>R</u> S-232C <u>p</u> arity <u>b</u> it (Even, Odd, None)	Choice E: even / O: odd / N: none	E: even
RSB	<u>R</u> S-232C <u>s</u> top <u>b</u> it(s)	Choice 1 / 2	2

(1) SET Reader function (SETR)

This command writes the functional conditions of the command in process into the nonvolatile memory in the reader. The setting shall be enabled at the upcoming startup.

Command	<code>SETR(S)Param1=Value1(S) . . . (S)ParamN=ValueN<LF></code> Note: <ul style="list-style-type: none"> • It specifies a parameter connecting a setting item to a setting value with equal. (The setting item does not have to be prepended with '-'.) • No space shall be put in from the beginning of the setting item to the end of the setting value. If the setting value includes any space, the space shall be enclosed with double quotation. In a single command, multiple setting items can be specified by separating with space. 2 or more character spaces are acceptable for indicating separation.
Response	<code>SETR[RC]<LF></code> [RC]: Response Code

*(S) Space Character

Example 1) When DHCP Enabled is set "ON":

```
[Tx] SETR dhe=1<LF>
[Rx] SETR0000<LF>
```

Example 2) When [Host name; V750-BA50C04, IP; 192.168.1.1, and Subnet mask; 255.255.255.0] is set:

```
[Tx] SETR lhn="V750-BA50C04" lip=192.168.1.1 lnm=255.255.255.0<LF>
[Rx] SETR0000<LF>
```

Example 3) When [RS-232C Baud rate; 19200bps, Data length; 7bit, Parity; Even, Stop; 1bit] is set:

```
[Tx] SETR rbr=19200 rdt=7 rpb=E rsb=1<LF>
[Rx] SETR0000<LF>
```

Example 4) When the setting parameter is incorrect:

```
[Tx] SETR abc=111<LF>
[Rx] SETR1421<LF>
```

(2) Get Reader (GETR)

This command reads the current functional conditions in the reader. Even after SET Reader command (SETR) is executed, the old information shall be read out unless the reboot is completed.

Command	<p>GETR(S)Param1(S)Param2(S)...(S)ParamN<LF></p> <p>Note:</p> <ul style="list-style-type: none"> • It specifies a parameter connecting a setting item to a setting value. ('The setting item does not have to be prepended with '-' .) • In a single command multiple setting items can be specified by separating with space. 2 or more character spaces are acceptable for indicating separation.
Response	<p>GETR[RC](S)[Param1=Value1](S)...(S)[ParamN=ValueN]<LF></p> <p>[RC]: Response Code [ParamN=ValueN]: Setting item and value</p> <p>Note:</p> <ul style="list-style-type: none"> • If multiple items are specified, the reader shall return response with connecting specified items to the setting values with equal in the specified order. Alphabetical characters included in the item name in the response shall be small characters. • If the setting value includes any space, the space shall be enclosed with double quotation.

*(S) Space Character

Example 1) When [Firmware version;100-100-100-0] is read:

```
[Tx] GETR fvw<LF>
[Rx] GETR0000 fvw=100-100-100-0<LF>
```

Example 2) When [Host name; V750-BA50C04, IP; 192.168.1.1, and Subnet mask; 255.255.255.0] is read:

```
[Tx] GETR lhn lip lnm<LF>
[Rx] GETR0000 lhn="V750-BA50C04" lip=192.168.1.1 lnm=255.255.255.0 <LF>
```

Example 3) When [RS-232C Baud rate; 19200bps, Data length; 7 bits, Parity; even, and Stop; 1bit] is read:

```
[Tx] GETR rbr rdt rpb rsb<LF>
[Rx] GETR0000 rbr=19200 rdt=7 rpb=E rsb=1<LF>
```

3.1.5.3 Communication Settings

To set the conditions to communicate with tags, following items shall be specified in the SET Communication command (SETC) and GET Communication command (GETC). Specifying following option allows the reader to set or read the communication condition. To write the setting data into the nonvolatile memories in the reader, SAVE command (SAVE) shall be executed.

Communication Settings [RF Control] (GETC/SETC)

Code	Content	User Setting Value	Factory Settings
PW1	UHF <u>power</u> level at port # <u>1</u>	Given value -Min: 10.0 -Max: 32.0 -Step: 0.5	31.5 (dBm)
PW2	UHF <u>power</u> level at port # <u>2</u>	Same as PW1	31.5 (dBm)
PW3	UHF <u>power</u> level at port # <u>3</u>	Same as PW1	31.5 (dBm)
PW4	UHF <u>power</u> level at port # <u>4</u>	Same as PW1	31.5 (dBm)
SS1	Gen2 <u>Session</u> value # <u>1</u> In case of Once Mode sequence	Choice 0 / 1 / 2 / 3	0
SS2	Gen2 <u>Session</u> value # <u>2</u> In case of Repeat Mode sequence	Choice 0 / 1 / 2 / 3	2
CMD	<u>Communication</u> <u>mode</u>	Choice 0: Normal mode 1: Dense reader mode (DRM)	0: Normal mode

Communication Settings [Filtering] (GETC/SETC)

Code	Content	User Setting Value	Factory Settings
FTE	<u>Filtering</u> <u>enable</u>	Choice 0: None 1: Filter1 only 2: Filter2 only 1&2: Filter1 and Filter2 1 2: Filter1 or Filter2	0:None
FT1	<u>Filtering</u> condition # <u>1</u>	Format: <i>FilterType(S)MemBank(S)Pointer(S)Length(S)Value</i> <i>FilterType</i> : 0 (fixed) <i>MemBank</i> : 0 to 3 <i>Pointer</i> : 0 to 255 (bit) <i>Length</i> : 1 to 255(bit) <i>Value</i> : XXXX... -Note: Set longer bits than the bits specified in the "Length" with 2-digit hexadecimal number ("0" to "F"). Max: 64 characters. The most significant bit is a Pointer of the Value.	(None)
FT2	<u>Filtering</u> condition # <u>2</u>	Same as FT1	(None)

Communication Settings [Smoothing] (GETC/SETC)

Code	Content	User Setting Value	Factory Settings
SBF	Prevents repeat read (<u>S</u> oothing <u>b</u> uffer size)	-Min: 0 (Disable) -Max: 999 -Step: 1	0:Disable
ONR	<u>O</u> mit <u>n</u> o tag <u>r</u> esponse	Choice 0:Disable / 1:Enable	0:Disable

(1) SET Communication (SETC)

This command writes the communication settings in the reader. While the command is being executed, setting conditions in the reader are changed. To write the setting data into the nonvolatile memories in the reader, SAVE command (SAVE) shall be executed. The new setting shall be enabled at the upcoming startup.

Command	<p>SETC(S)Param1=Value1(S)...(S)ParamN=ValueN<LF></p> <p>Note:</p> <ul style="list-style-type: none"> • It specifies a parameter connecting a setting item to a setting value. ('The setting item does not have to be prepended with '-' .) • No space shall be put in from the beginning of the setting item to the end of the setting value unless setting item is ft1 or ft2. • If you specify ft1 and ft2 for filtering, set ft1, ft2 and fte at one sequent action. ft1 and ft2 shall be always followed by Filtering Enable (fte). If you specify them in one command SETC, firstly put ft1 and ft2 then fte in order. If you change the filtering conditions with ft1 and/or ft2, the filtering function will be temporarily Disabled. • If the setting item is ft1 or ft2, the five items shall be specified with space separation between each item. Instead of space, enclosing double quotations is not allowable. • In a single command, multiple setting items can be specified by separating with space. 2 or more character spaces are acceptable for indicating separation.
Response	<p>SETC[RC]<LF></p> <p>[RC]: Response Code</p>

*(S) Space Character

Example 1) When [Antenna port #1 power; 10, Gen2 session for Once Mode Reading; 1] is specified:

```
[Tx] SETC pw1=10 ss1=1<LF>
[Rx] SETC0000<LF>
```

Example 2) When [Filter; 1 or 2, Filter1's Bank; 1, Pointer; 8, Length; 2, Data; C0(11b), Filter2's Bank 1, Pointer; 20, Length;16 ,Data; 125A(00010010 01011010b)] is specified:

```
[Tx] SETC ft1=0 1 8 2 C0<LF>
[Rx] SETC0000<LF>
[Tx] SETC ft2=0 1 20 16 125A<LF>
[Rx] SETC0000<LF>
[Tx] SETC fte=1|2<LF>
[Rx] SETC0000<LF>
```

(2) GET Communication (GETC)

This command allows the reader to read the current communication conditions. Just after SET Communication command (SETC) is executed, new information shall be read out.

Command	<p>GETC (S)Param1 (S)Param2(S)...(S)ParamN<LF></p> <p>Note:</p> <ul style="list-style-type: none"> • It specifies a parameter connecting a setting item to a setting value. ('The setting item does not have to be prepended with '-' .) • In a single command, multiple setting items can be specified by separating with space. (2 or more character space are acceptable for indicating separation.)
Response	<p>GETC[RC](S)[Param1=Value1](S)...(S)[ParamN=ValueN]<LF></p> <p>[RC]: Response Code [ParamN=ValueN]: Setting item and values</p> <p>Note:</p> <ul style="list-style-type: none"> • If multiple items are specified, the reader shall return response with connecting specified items to the setting values with equal in the specified order. Alphabetical characters included in the item name in the response shall be small characters. • If the setting item is ft1 or ft2, the five items shall be returned with space separation between each item. Double quotations shall not be used for enclosing.

*(S) Space Character

Example 1) When [Antenna port #1 UHF power, Gen2 session value for Once Mode Reading] is read out:

```
[Tx] GETC pw1 ss1<LF>
[Rx] GETC0000 pw1=10 ss1=1<LF>
```

Example 2) When [Filter setting, Filter condition 1, Filter condition 2] is read out:

```
[Tx] GETC fte ft1 ft2<LF>
[Rx] GETC0000 fte=1&2 ft1=0 1 8 2 C0 ft2=0 1 20 16 125A<LF>
```

(3) SAVE communication setting (SAVE)

This command allows the reader to write communication setting into the nonvolatile memories in the reader. If SET Communication command (SETC) is executed and then the reader is started up without executing this command (SAVE), new setting will be abandoned.

Command	SAVE<LF> Note: No arguments.
Response	SAVE[RC]<LF> [RC]: Response Code

Example 1) When communication setting is saved (New setting is written into the nonvolatile memory):

```
[Tx] SAVE<LF>  
[Rx] SAVE0000<LF>
```

3.1.5.4 Operation Settings

Specifying following option in the operation setting command (SETO) or operation read command (GETO) enables to set or read the reader's operation settings.

Operation Settings [Command Entry] (GETO/SETO)

Code	Content	User Setting Value	Factory Settings
RIF	Response Interface	Choice 0:None 1:Ethernet 2:RS-232C	1:Ethernet
IEC	Command to be execute at startup.	Given string Format: <i>Function(S)"Command"</i> <i>Function</i> 0: unregistered 1: execute command <i>"Command"</i> Command to be execute ex. "RDID -seq SOC -tmo 500" -Max: 255 characters, ASCII -Note: This setting value has double quotation marks.	(None)
IN1	Input port #1 function setting	Format: <i>Function(S)Timing(S)"Command"</i> <i>Function</i> 0:None 1:Command execution <i>Timing</i> 0:Startup (Fixed) <i>"Command"</i> Command to be execute Ex. "RDID -seq SOC -tmo 500" -Max: 255 characters, ASCII -Note: This setting value has double quotation marks. -Note: Only when the <i>Function</i> is specified with "1", set the <i>Timing</i> and the <i>"Command"</i> . When the <i>Function</i> is specified with "0", executed <i>"Command"</i> data is saved and response data is returned.	(None)
IN2	Input port #2 function setting	Same as IN1	(None)
IN3	Input port #3 function setting	Same as IN1	(None)
IN4	Input port #4 function setting	Same as IN1	(None)

Operation Settings [Programmable Output] (GETO/SETO)

Code	Content	User Setting Value	Factory Settings
OT1	Output port #1 function setting	Format: <i>Timing(S)OutputTime(S)Condition</i> <i>Timing</i> 00:None (User input) 11:RUN output (The reader is running normally.) 12:ERR output (The reader stopped with error.) 20:COM output (The reader is communicating.) 2n:ATn Current antenna(s) (n=1 to 4) (The reader is communicating with specified antenna) 31:NML (Evaluated normal completion) 32:ERC (Evaluated completion with error occurring) <i>OutputTime</i> 10 to 9990 (ms) 0 (Status kept until upcoming evaluation.) - Note: Output time is effective only for NML/ERC setting. <i>Condition</i> -Note: Output time is effective only for NML/ERC setting. - Note: If the condition is omitted, output signal shall be on without condition. * Refer to the following list.	(None)
OT2	Output port #2 function setting	Same as OT1	(None)
OT3	Output port #3 function setting	Same as OT1	(None)
OT4	Output port #4 function setting	Same as OT1	(None)

The format of status judgment expression

1) If the NML mode is specified in output function setting, you can set conditions by using the following format.

Condition A Condition B	Comparison symbol data	"DAT": data to be read "TCT": tag count to be read
	Comparison operators	(1) When comparison symbol data is "DAT": "==" : Left side data is equal to right side data. "!=" : Left side data is not equal to right side data. (2) When comparison symbol data is "TCT": "==" : Left side data is equal to right side data. "!=" : Left side data is not equal to right side data. ">=" : Left side data is bigger than right side data. "<=" : Left side data is smaller than right side data.
	Comparison data	(1) When comparison symbol data is "DAT": XXXX... [Hex] (X: 0 to 9 , A to F) • "*" mark is a wild card • When the data length is different, the result shall be incorrect. • When the command has -tif option, comparison symbol data "DAT" has all tag information that the reader read. • When comparison symbol data is ",", specify with "*" mark. (2) When comparison symbol data is "TCT": 0 to 999
Logical operator		"&": AND operator Format: condition A & condition B " ": OR operator Format: condition A condition B

* If there is no condition to be set, the output signal shall be on after normal end.

* If there is no condition to be set or condition (A) is set, condition (B) shall not be included in the setting.

Ex.) When the read data is 12bytes (24character) and the characters from 5th to 8th in it is "0000" or when the number of tags is 8 or more:

"DAT==***0000***** | TCT>=8"

2) If the ERC mode is specified for output function setting, you can set conditions with the following format.

Condition	Comparison symbol data	"DAT": error code (Two characters from the head in error code.) - "TCT" is not supported.
	Comparison operators	"==" : matched When the error code is in specified error code list: "!=" : unmatched When the error code is not in specified error code list:
	Error code specifying.	It specifies error codes for comparison in series. (Max 6 error code can be specified.) ex. "7071"...

* If there is no condition to be set, the output signal shall be on after error end.

Ex.) When communication error (Error code is 70xx) or verify error (Error code is 71xx) has been occurred:

"DAT ==7071"

(1) Set Operation (SETO)

This command is to write operation conditions into the nonvolatile memories in the reader. The new setting shall be enabled at the upcoming startup.

Command	<code>SETO(S)Param1=Value1<LF></code> Note: <ul style="list-style-type: none"> • Putting equal between a single setting item and a setting value specifies the value (no need to put '-' before setting item). • Multiple setting items can not be applicable.
Response	<code>SETO[RC]<LF></code> [RC]: Response Code

*(S) Space Character

Example 1) When the Response I/F after command execution is set RS-232C:

```
[Tx] SETO rif=2<LF>
[Rx] SETO0000<LF>
```

Example 2) When the executed command at the start up is set as ["RDID -ant 122322 -tmo 100"]:

```
[Tx] SETO iec=1 "RDID -ant 122322 -tmo 100"<LF>
[Rx] SETO0000<LF>
```

Example 3) When Input 1 function setting is set as [Command execution, start up edge, "RDID -ant 122322 -tmo 100"]:

```
[Tx] SETO in1=1 0 "RDID -ant 122322 -tmo 100"<LF>
[Rx] SETO0000<LF>
```

Example 4) When output 3 function setting is set as [Signal is on for 2 seconds] when the executed command is finished normally, the read data is 12bytes(24characters) and the 5th to 8th data is "0000":

```
[Tx] SETO ot3=31 2000 dat==****0000*****<LF>
[Rx] SETO0000<LF>
```

Example 5) When output 4 function setting is set as [Signal is on for 1 second] if tag count is 10 or less:

```
[Tx] SETO ot4=31 1000 TCT<=10<LF>
[Rx] SETO0000<LF>
```

Example 6) When output 2 function setting is set as [Signal is on for 1 second] if both conditions on example 5 and 6 are fulfilled:

```
[Tx] SETO ot2=31 1000 DAT==****0000*****&TCT<=10<LF>
[Rx] SETO0000<LF>
```

Example 7) When output 2 function setting is set [Signal keep on when ERC(Communication error)]:

```
[Tx] SETO ot2=32 0<LF>
[Rx] SETO0000<LF>
```

Example 8) When output 2 function setting is set as [Signal is on for 2 seconds] if any code error of 71xx, 72xx or 7Axx is occurred:

```
[Tx] SETO ot2=32 2000 71727A<LF>
[Rx] SETO0000<LF>
```

Example 9) When output 1 function setting is deleted:

```
[Tx] SETO ot1=00<LF>
[Rx] SETO0000<LF>
```

(2) Get Operation (GETO)

This command allows the reader to read the current operation conditions. Even after setting operation command (SETO) is executed, the old information shall be read out unless the reboot is completed.

Command	GETO(S)Param1<LF> Note: • Specifies a single setting item. (not required '-' before the item) • Multiple setting items cannot not be specified.
Response	GETO[RC](S)[Param1=Value1]<LF> [RC]: Response Code [Param1=Value1]: Setting item and values

*(S) Space Character

Example 1) When executed command is read at startup:

```
[Tx] GETO iec<LF>
[Rx] GETO0000 iec=1 "RDID -ANT 122322 -TMO 100"<LF>
```

Example 2) When Input 2 function setting is never registered:

```
[Tx] GETO in2<LF>
[Rx] GETO0000 in2=0 0<LF>
```

Example 3) When Input 1 function setting is read:

```
[Tx] GETO in1<LF>
[Rx] GETO0000 in1=1 0 "RDID -ANT 122322 -TMO 100"<LF>
```

Example 4) When Input 3 function setting is read but the setting is not alive:

```
[Tx] GETO in3<LF>
[Rx] GETO0000 in3=0 0 "RDID -SEQ MOC -ANT 123"<LF>
```

Example 5) When Output 4 function setting is never registered:

```
[Tx] GETO ot4<LF>
[Rx] GETO0000 ot4=00 0<LF>
```

Example 6) When Output 1 function setting is read:

```
[Tx] GETO ot1<LF>
[Rx] GETO0000 ot1=31 2000 DAT==****0000*****<LF>
```

Example 7) When Output 2 function setting is read and the setting is not alive:

```
[Tx] GETO ot2<LF>
[Rx] GETO0000 ot2=00 2000 DAT==****0000*****<LF>
```

3.1.5.5 Control Command

(1) Initialize setting (INIT)

This command initializes all setting of reader to the factory default setting. All settings shall be written into the inner nonvolatile memories. After executing this INIT command, the reader requires reboot.

Command	INIT<LF> Note: No argument
Response	INIT[RC]<LF> [RC]: Response Code

Example 1) All setting of reader is initialized to the factory default setting:

```
[Tx] INIT<LF>  
[Rx] INIT0000<LF>
```

(2) Stop the repeating operation (STOP)

This command instructs the reader to stop the operation in process.

Command	STOP<LF> Note: No arguments
Response	STOP[RC]<LF> [RC]: Response Code

* The communication process is not running in the reader, the error is returned [Code: 1500].

Example 1) When the reader stops multi-repeat communication:

```
[Tx] RDID -seq MRP -ant 12 ---- Read ID command is started under multi-repeat mode.
[Tx] STOP<LF>
[Rx] STOP0000<LF>
```

(3) External Input Output control (EXIO)

This command allows the reader to output ON/OFF to the output terminal and read an input terminal status. If output port(s) is connected to the device(s) that is not used for general purpose, the reader ignores ON/OFF output for the port(s). If output setting value is omitted, the reader shall read the input and output status.

Command	EXIO<LF> (For input/output port status read) EXIO(S)OutputSignal<LF> (For output status specifying) OutputSignal: For OUT1-4, values are set with four characters (left to the right; 1-4) ("0"-OFF / "1"-ON / "*" -Don't care)
Response	EXIO[RC](S)[InputSignal](S)[OutputSignal]<LF> [RC]: Response Code 0000: Fixed [InputSignal]: For IN1-4, signal values 0 or 1 are set with four characters (left to the right). [OutputSignal]: For OUT1-4, signal values 0 or 1 are set with four characters (left to the right). ("0"-OFF / "1"-ON)

*(S) Space Character

Example 1) When [Output 1; High, Output 2; Low, Output 3; High, Output 4; Low] is specified:

```
[Tx] EXIO 1010
[Rx] EXIO0000 1111 1010
```

Example 2) When [Getting I/O status] is specified:

```
[Tx] EXIO<LF>
[Rx] EXIO0000 1011 1001<LF>
(From the left side, the following status is shown; IN1...IN4, OUT1...OUT4)
```

(4) Reset (RSET)

This command reboots the reader after the reader returns the response that the command has received. When it is connected via Ethernet, it is disconnect the network connection before rebooting.

Command	REST<LF> Note: No arguments.
Response	REST[RC]<LF> [RC]: Response Code

Example 1) Reboot the reader:

```
[Tx] REST<LF>  
[Rx] REST0000<LF>
```

(5) Good Bye (GBYE) – Shut down connection

This command enables to shut down connection with Ethernet. After the reader received the command, it returns the response that the command has received. And the network connection is disconnected after 1 second.

Command	GBYE<LF> Note: No argument
Response	GBYE[RC]<LF> [RC]: Response Code

Example 1) Disconnect the Ethernet connection between host and the reader.

```
[Tx] GBYE<LF>  
[Rx] GBYE0000<LF>
```

(6) Request Resend (RRES)

This command instructs the reader to re-send the latest response data that has been sent. This command shall not be accepted when the other command such as Repeat mode is being processed.

Command	RRES<LF> Note: No argument
Response	The latest response

* If there is no the latest response data, the error is returned [Code:1500].

* When the communication mode is SRP/MRP, it can be accepted. But if the timeout value is so small that the reader may not identify various responses returned continuously.

Example 1) When the host requests to resend the response for the successful single ID read command (RDID -seq SOC -ant 1 -tif EPC,ANT) that has been executed most lately:

```
[Tx] RRES<LF>
[Rx] RDID0000 001 FFFFFFFEEDDD8CE2BBBB1073,1<LF>
```

(7) Test System (TEST)

This command instructs the reader to return the reader status data and the exact data message just after receiving it from the host. It is to test a communication line and to get reader status.

Command	TEST(S) <i>TestData</i> <LF> <i>TestData</i> : Given string
Response	TEST[RC](S)[ReaderStatus](S)[TestData]<LF> [RC]: Response Code [ReaderStatus]: Reader's status code 00:Waiting for command 10:Communicating 3x:Setting error 4x:System error 90:Running on Safe Mode [TestData]: Same data as command parameter

*(S) Space Character

Example 1) When test data "uhf rfid" is entered to check a communication status between the host and the reader:

```
[Tx] TEST uhf rfid<LF>
[Rx] TEST0000 00 uhf rfid <LF>
```

Example 2) The reader's status check:

```
[Tx] TEST<LF>
[Rx] TEST0000 00<LF>
```

(8) Noise monitoring (NOIS)

This command is to check the noise level of the specified antenna.

Command	<code>NOIS(S)Mode(S)Antenna<LF></code> <i>Mode</i> : noise level measurement mode (0: fixed) <i>Antenna</i> : the port number of antenna (1-4) that is to check the noise level.
Response	<code>NOIS[RC](S)[ch1 and ch2](S)[ch3 and ch4](S)...</code> <code>... (S)[ch49 and ch50]<LF></code> [RC]: Response Code [ch1 and ch2] to [ch49 and ch50]: Noise level of each communication channel. *The response data has a noise level every 2channels (1MHz band, 1ch and 2ch, 3ch and 4ch, ..., 49ch and 50ch).

* (S) Space Character

Example 1) Noise level check for the antenna port 1:

```
[Tx] NOIS 0 1<LF>
[Rx] NOIS0000 0000032A 00000345 000003B9 000003E0 ... 00000339<LF>
```

3.2 Examples

Examples given in this section are provided as a guide for the user in determining command suitability. They do not constitute a warranty. You should verify operation in their specific environment and application.

3.2.1 Example 1

To read a tag attached on the same face to each case that rushes on conveyor in high speed, Single Repeat sequence is appropriate. An example command is the following:

```
Command: RDID -seq SRP -ant 1 -tmo 200
```

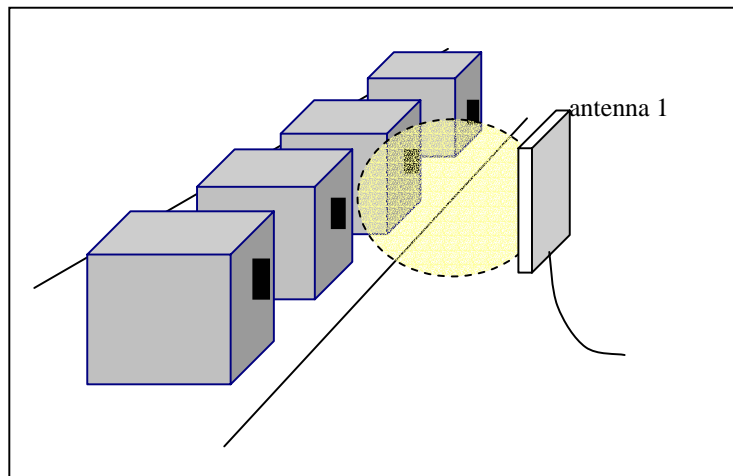

3.2.2 Example 2

To read a tag attached on various faces (top face is the most) to each case that passes through a gate on a conveyor, the client software finds tags using 3 antennas (making much of antenna 2). An example is the following:

```
Command: RDID -seq SRP -ant 212232 -tmo 1000
```

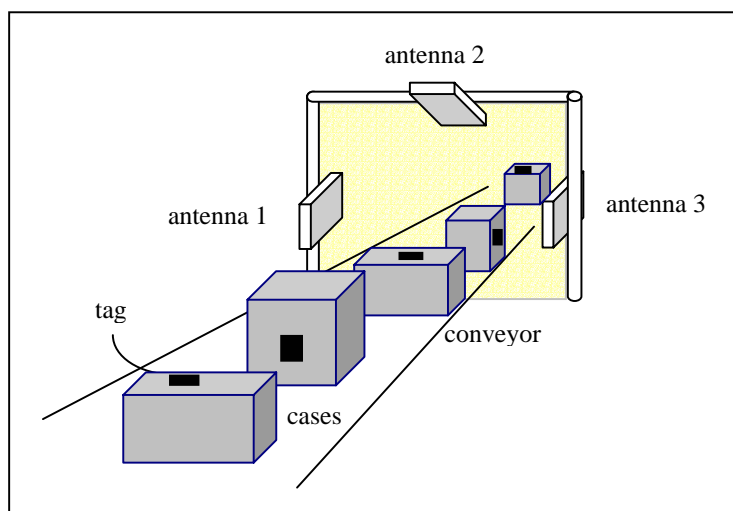

3.2.3 Example 3

To read multiple tags attached on the same face to each case on a pallet that passes through a gate, multi repeat sequence is appropriate. When the client software finds tags using 3 antennas (mainly use antenna 2), an example is the following:

```
Command: RDID -seq MRP -ant 22212223 -tmo 2000
```

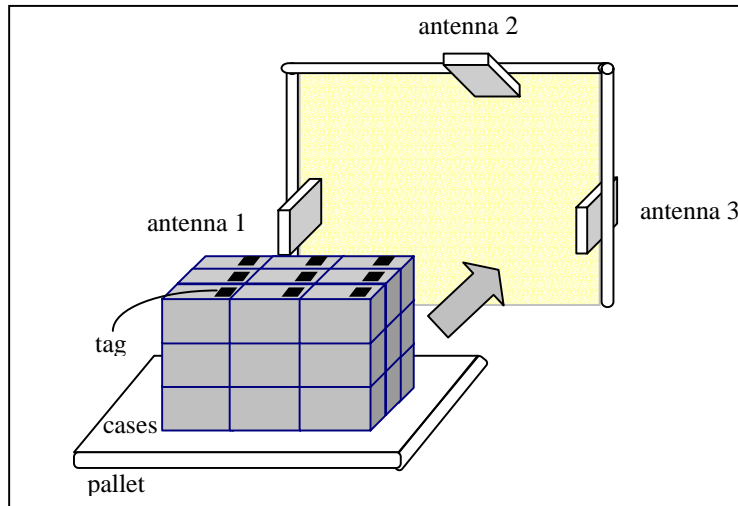

3.2.4 Example 4

Automated pass check at a portal gate.

This system enables the reader to check whether it reads 9 tags in total when carton boxes with tags pass through the portal. After checking, the reader reports the result to the forklift driver by using the stack lights.

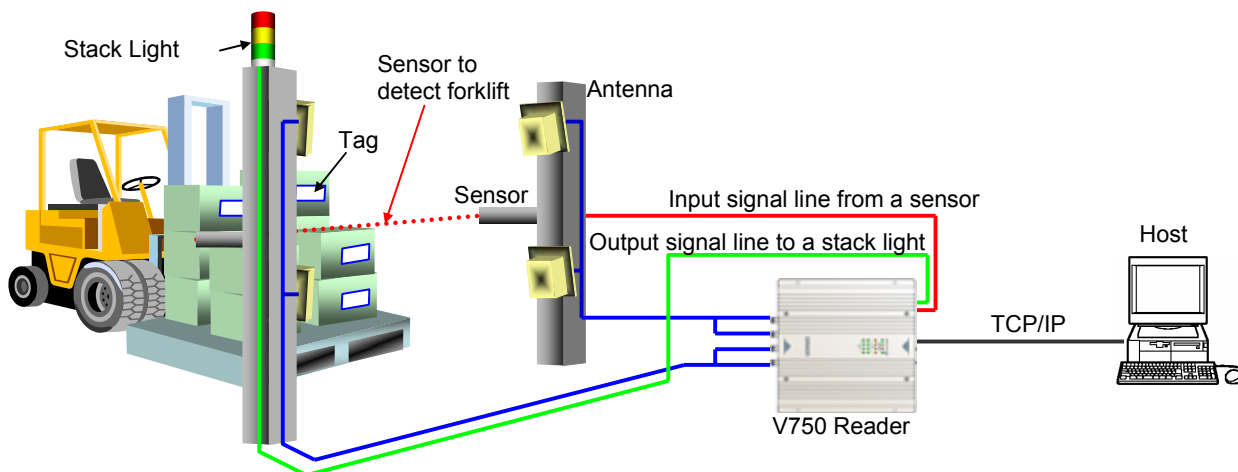

Operating conditions in the reader

I/O port	Function and registered content
Input port #1	To register the command to read multiple tags for 2 second when the signal of the Input port #1 turns on. (If the sensor detects a forklift, the signal of Input port #1 turns on.) Command to register: SETO in1=1 0 "RDID -seq MOC -ant 1234 -tmo 2000"
Output port #1	To register the command to turn on the signal of the Output port #1 when the reader reads 9 tags normally. (When the signal of the Output port #1 turns on, blue light turns on.) Command to register: SETO ot1=31 1000 TCT==9
Output port #2	To register the command to turn on the signal of the Output port #2 when the reader is reading tag(s). (When the signal of the Output port #2 turns on, the yellow light turns on.) Command to register: SETO ot2=20
Output port #3	To register the command to turn on the signal of the Output port #3 when the reader can not reads 9 tags. (If the signal of the Output port #3 turns on, a red light turns on.) Command to register: SETO ot3=31 1000 TCT!=9

Photo sensor

Item	Meaning	Connection
Sensor	Detects the forklift is coming to the portal gate. * When the sensor detects the forklift, the signal line is turned Off to On	The signal line is connected input port #1 of the reader.

Stack lights

Item	Meaning	Connection
Light1(Blue)	Means that all tags were read. * When the signal line is turn Off to On, the light is turned on.	The signal line is connected output port #1 of the reader.
Light2(Yellow)	Means in communication. * When the signal line is turn Off to On, the light is turned on.	The signal line is connected output port #2 of the reader.
Light3(Red)	Means that read tags were insufficient. * When the signal line is turn Off to On, the light is turned on.	The signal line is connected output port #3 of the reader.

Communication sequence (All tags are read normally.)

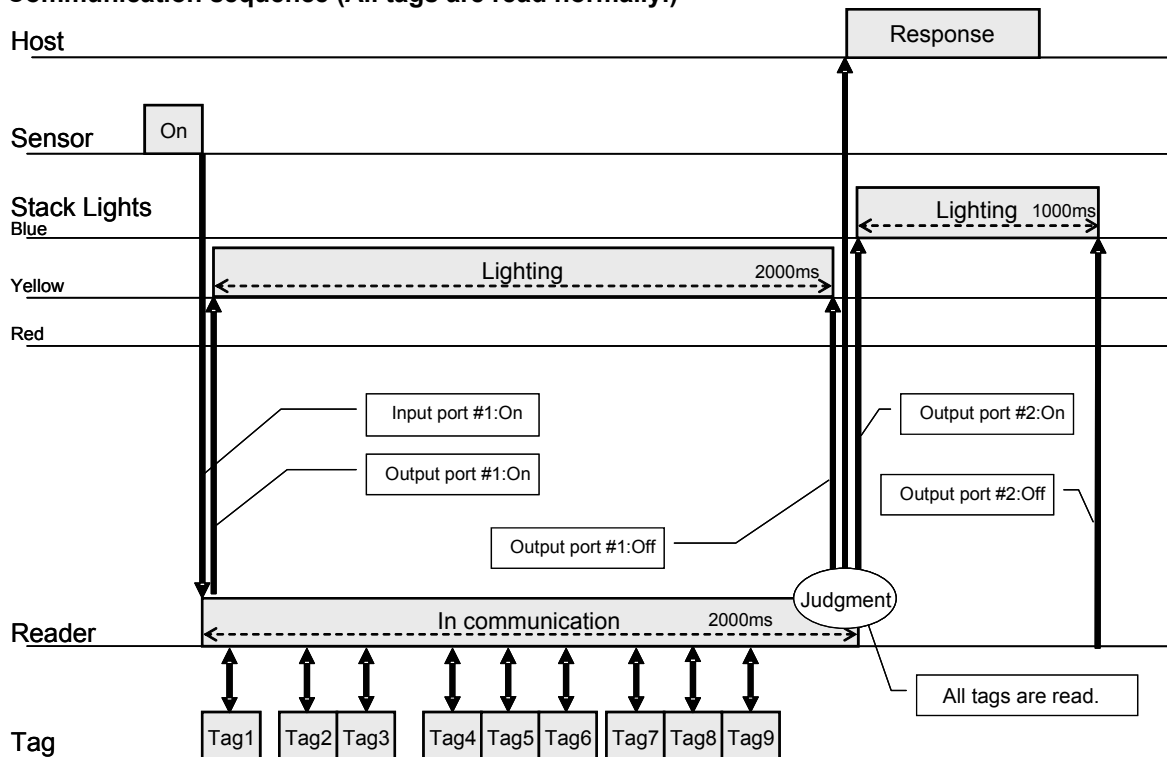

3.2.5 Example 5

Auto sorting with conveyor belt

This system enables the reader to read tag's addresses and to output signal when it detects the tags that have target addresses.

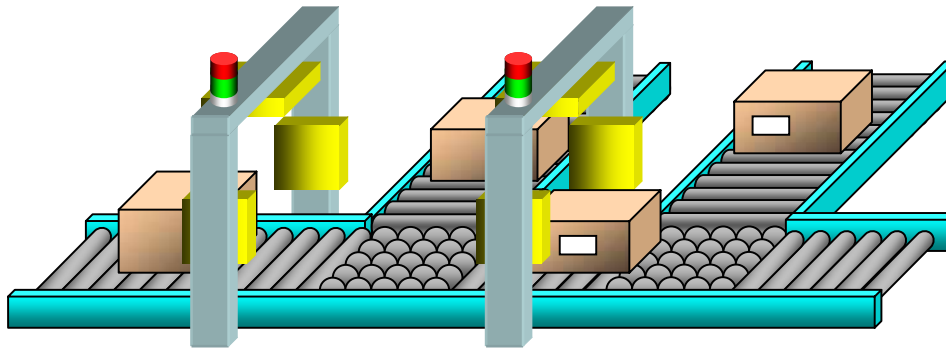

Operating conditions in the reader

Item	Setting
Command at startup	ID read is operated repeatedly in Single repeat mode when power turns on. SETO iec=1 "RDID -seq SRP -ant 1"
Communication setup	Prevents over-rapped read (Buffur=5). No tag response is set. SETC sbf=5 onr=1 SAVE
OUT1	Data match output setting: Data length is 96bit. If the first data is EPC 0x30, output signal is on for 100ms. SETO ot1=31 100 DAT==30*****
OUT2	Data unmatched output: Data length is other than 96bit. If the first data is not 0x30, output signal is on for 100ms. SETO ot2=31 100 DAT!=30*****
OUT3	Read result output: Output signal is on for 100ms when data is read. SETO ot3=31 100

Communication sequence

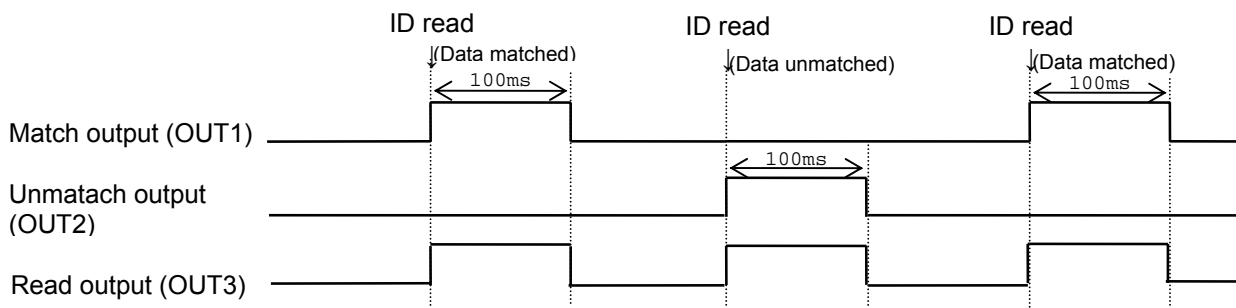

4. Browser-Based Interface

About this Guide

This chapter explains reader's functions for changing settings, testing commands, monitoring status of command execution, logged error and noise level and updating firmware via web browser interface remotely.

4.1 Using the Browser-Based Interface

You can display and operate the reader's Web interface by accessing the reader's IP address (the default is 192.168.1.200) via Web browser enabled Java(TM) Runtime.

Only one user can access to this web interface at a time. When a user-A is operating via web interface and if another user-B accesses to the same reader, only the user-B can operate it.

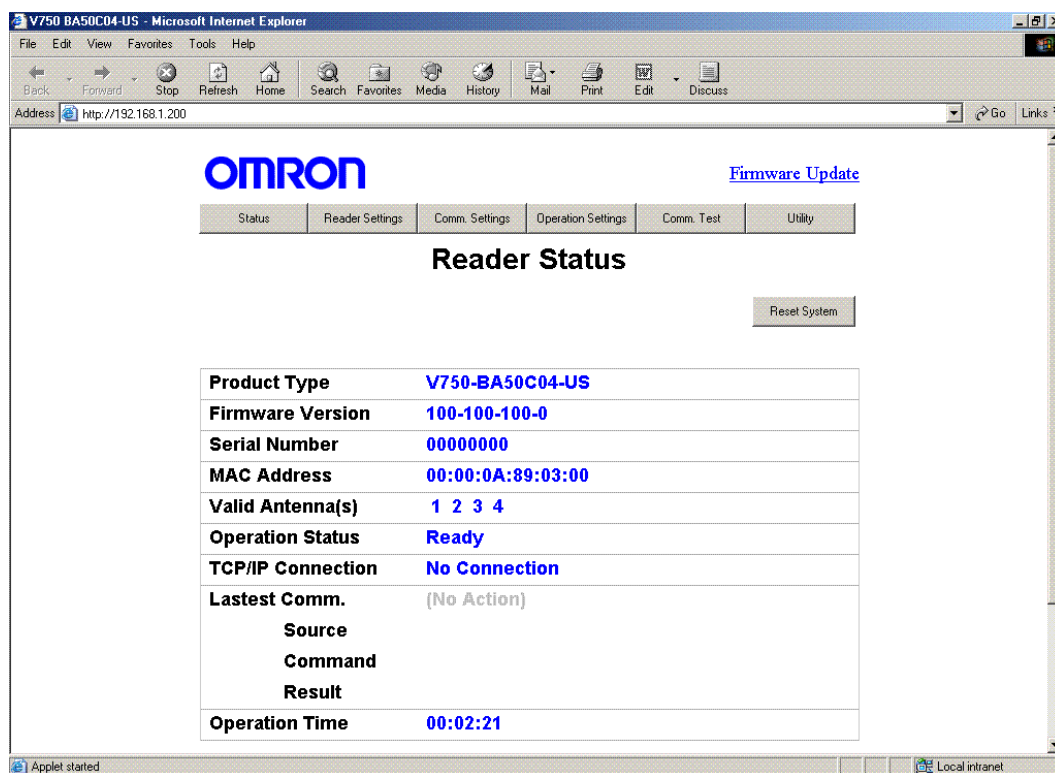

On each mode the reader has, the web interface serves different functions.

Operation Mode	Provides various functions the reader has.
Safe Mode	Displays the reader's essential settings.
Update Mode	Shows the process updating its firmware.

Explain of each mode is the following.

* This function is checked on Windows XP Professional and Internet Explorer 6 (SP 2) with J2SE 1.4.

* Java(TM) is trademark of Sun Microsystems.

* If you have not installed Java in your computer, download Java Runtime Environment (JRE) from <http://www.java.com/>.

4.2 Operation Mode

4.2.1 Page List

The reader has functions to operate it easily. The page names and their functions are shown in the following table.

Page Name		Function
Status		Shows reader's information and running status.
Reader Settings		Shows and changes reader's interface settings. (Reader Information, Ethernet, RS-232C)
Communication Settings (Comm. Settings)		Shows and changes communication settings. (RF Control, Filtering, Smoothing)
Operation Settings		Shows and changes operation settings (Command Entry, Programmable Output)
Communication Test (Comm. Test)		Provides communication test with tags.
Utility	Latest Error Logging	Shows the latest error log data.
	History of Error Logging	Shows the accumulated error count data.
	Noise Check	Shows noise level with a bar graph.
Firmware Update		Provides method to update the firmware of the reader.

When you access the web interface at first, the Status page is shown at first. At the top of the page, you can see menu buttons to access to other pages.

When you press [Utility] button, submenu buttons of utility page are shown below the [Utility] button.

When you click another page's menu button for the first time after boot, you can see a warning dialog that displays "The web operation might affect the control from command line interface (Ethernet/RS-232C)". You can go another page only when you click [OK] button.

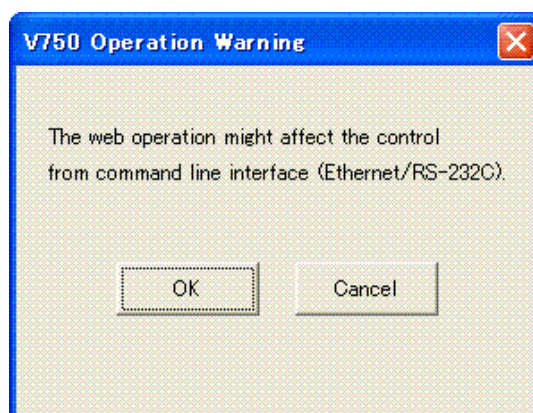

4.2.2 Status

Function

When you access the reader via browser, this window appears as a main page. The page provides current status information of the reader.

Screen Image

The screenshot shows the OMRON Reader Status web page. At the top left is the OMRON logo. To its right is a 'Page Menu' with buttons for 'Status', 'Reader Settings', 'Comm. Settings', 'Operation Settings', 'Comm. Test', and 'Utility'. In the top right corner, there is a 'Firmware Update' link. The main heading is 'Reader Status'. Below this heading is an 'Action Button' labeled 'Reset System'. A table titled 'Items' displays the following data:

Product Type	V750-BA50C04-US
Firmware Version	100-100-100-0
Serial Number	00000000
MAC Address	00:00:0A:89:03:00
Valid Antenna(s)	1 2 3 4
Operation Status	Communicating
TCP/IP Connection	Connected
Latest Comm.	Active
Source	Ethernet
Command	RDID -ANT 1 -SEQ MRP -TMO 1000
Result	RDID0000 007
Operation Time	00:01:54

This table shows the current reader status, including fixed data the reader has individually and flexible data changing depending on the communication status.

Once a communication command has been executed, the Latest Communication is changed as the command is processed. For example, when the host sends the following command code via Ethernet port;[RDID -ant 1 -seq MRP -tmo 1000] and receives response [RDID0000 007], the page appears as above.

Description of Each Item

Item	Description	Note
Product Type	Type name of the product V750-BA50C04-US	Fixed data
Firmware Version	Firmware version currently installed in the reader. XXX-XXX-XXX-X	Stable data if not updated firmware
Serial Number	Unique number for product set in the factory.	Fixed data
MAC Address	The reader's MAC address.	Fixed data
Valid Antenna(s)	Antenna(s) the reader has detected at start-up. - In blue: valid - In light gray: invalid	Stable data that does not change after start-up
Operation Status	Indicates the reader's status with the following code. - Ready: waiting for command - Communicating : command being executed - Setting Error - XXX(YY):Setting Error occurred - System Error (ZZ) : system error occurred	See below the Error code list for detail. (*1)
TCP/IP Connection	Indicates TCP/IP port connection status: No Connection / Connected	
Latest Communication (Latest Comm.)	Indicates "Active" in orange if a command is being executed.	
Source	Interface name of command execution source. Ethernet / RS-232C / IN1 / IN2 / IN3 / IN4 / Web	It indicates the current command status by using command I/F (Ethernet/RS-232C) or the other registered command.
Command	The command code that is being executed. Ex.) RDID -ANT 1 -TMO 1000	It indicates the executed command.
Result	Executed result (Command, response code, and the number of tags) Ex.) RDID0000 001	After communication completed, the response are shown. It remains blank if the command is being executed or has not been executed yet.
Operation time	Time past after start up. Ex.) 01:23:45.	Time starts with "00:00:00" at the start-up. If the time exceeds 9999:59:59, the indication returns "00:00:00".

*1) About the Error code:

If the error is indicated as XXX(YY), Setting Error has occurred. XXX means error cause and YY means error type (see below error code list).

If the error is indicated as ZZ, it means System Error has occurred. ZZ means error code.

On Setting Error, reason of the error is displayed with both error code and the description.

On System Error, only error code is displayed.

Setting Error code and Description list

Description (XXX)	Status code (YY)	Error type
DHCP Server	31	DHCP Server error
Comm. Settings	33	Communication setting error
Comm. Settings	35	Communication setting error
Operation Settings	36	Operation setting error
Reader Settings	37	Reader setting error

Action

[Reset System]

To reboot the system, push the [Reset System] button. After rebooting the reader, you can access the browser by clicking Reload button or opening another browser.



Errors

1) Can No Connect

It means that the host computer can not receive the data from the reader. In this case, you have to check the Ethernet connection, restart the browser and then access the reader again.

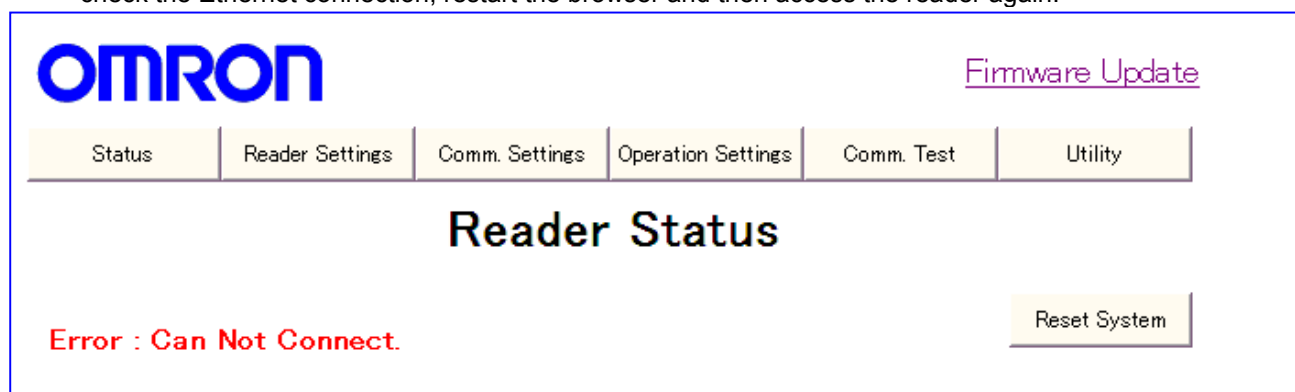

4.2.3 Reader Settings

Function

In this page, you can see and change the reader information, Ethernet and RS-232C settings.

Screen Image

[Firmware Update](#)

Status
Reader Settings
Comm. Settings
Operation Settings
Comm. Test
Utility

Reader Settings

Reader Information

Save

Reader Name

Reader Role

Ethernet

Host Name

Domain Name

DHCP OFF ON

IP Address

Subnet Mask

Gateway

TCP/IP Port

RS-232C

Baud Rate [bps] 9600 19200 38400 57600

Data Bits 7 8

Parity Bit Even Odd None

Stop Bit(s) 1 2

Description of Each Item

Reader Information

Item	Description	The range of the set code.	Default
Reader Name	Reader name defined by its user.	Represented with from 1 to 63 ASCII characters.	(None)
Reader Role	The role of the reader defined by its user.	Represented with from 1 to 63 ASCII characters.	(None)

Ethernet

Item	Description	The range of the set code.	Default
Host Name	Name to refer the host in the network	Represented with from 1 to 63 ASCII characters.	V750-BA50C04-US
Domain Name	Domain name in the network environment for the reader.	Represented with from 1 to 67 ASCII characters.	(None)
DHCP	Whether the reader uses DHCP serve or not.	Disabled / Enabled	Disabled
IP Address	IP address of the reader		192.168.1.200
Subnet Mask	The reader's subnet mask address.		255.255.255.0
Gateway	The reader's Gateway address.		192.168.1.254
TCP/IP Port	Port number of command interface.	1025 to 65534	7090

RS-232C

Item	Description	The range of the set code.	Default
Baud Rate (bps)	Communication speed	9600 / 19200 / 38400 / 57600	57600
Data Bits	Communication data length	7 / 8	7
Parity Bit	Parity bit	Even / Odd / None	Even
Stop Bit(s)	Stop bit	1 / 2	2

Action

[Save]

To save the setting of the reader, enter the values and push [Save] button, then all the displayed values are set in the reader's internal memory. They become effective as a default value after booting next time. All the saving process is finished successfully, the reader displays "Successfully Saved" in the page.

Saving process is executed in the displayed order, from the reader Information, Ethernet, to the RS-232C.

If saving process is succeeded, the label changes its color from black to blue. If failed, it changes to red. If the process fails to complete and stops, the latter items are not saved and they remain in black.

The screenshot shows the OMRON web interface. At the top left is the OMRON logo. At the top right is a link for 'Firmware Update'. Below these is a navigation menu with six items: 'Status', 'Reader Settings', 'Comm. Settings', 'Operation Settings', 'Comm. Test', and 'Utility'. The 'Reader Settings' item is highlighted. The main heading is 'Reader Settings'. Below the heading, a message reads 'Successfully Saved.'

Errors

1) Invalid Parameter(s) in [XXX]

It indicates that the data set in XXX is incorrect. (XXX will be one of Reader Information, Ethernet or RS-232C.) In this case, correct the data and click [Save] button again.

2) Can Not Connect

It means that the host computer can not receive the data from the reader. In this case, you have to check the Ethernet connection, restart the browser and then access the reader again.

3) This Function is NOT Available Now

It means that saving process can not be executed because of reader status.

The screenshot shows the OMRON web interface with an error message. At the top left is the OMRON logo. At the top right is a link for 'Firmware Update'. Below these is a navigation menu with six items: 'Status', 'Reader Settings', 'Comm. Settings', 'Operation Settings', 'Comm. Test', and 'Utility'. The 'Reader Settings' item is highlighted. The main heading is 'Reader Settings'. Below the heading, a red error message reads 'Error : Invalid Parameter(s) in [Reader Information]'. Below the error message, the text 'Reader Information' is displayed. To the right of the error message is a 'Save' button.

4.2.4 Communication Settings

Function

In this page, you can see and change the communication settings, RF control, filtering and smoothing.

Screen Image

[Firmware Update](#)

Status
Reader Settings
Comm. Settings
Operation Settings
Comm. Test
Utility

Communication Settings

Apply
Save

RF Control

Antenna Power ANTI: ANT2: ANT3: ANT4:

Session SOC/MOC: SRP/MRP:

Mode Normal DRM

Filtering

Condition Selection

Condition 1 Bank: 0 1 2 3

Pointer

Length(bit)

Data

Condition 2 Bank: 0 1 2 3

Pointer

Length(bit)

Data

Smoothing

Smoothing Buffer

Omit Response Disable Enable

Description of Each Item

RF Control

Item	Description	The range of the set code.	Default
Antenna Power	Power (dBm) of each antenna (from 1 to 4)	10.0 to 32.0 (Truncate by 0.5. Ex. 10.3 is truncated to 10.0 and 10.8 is truncated to 10.5.)	Every antenna: 31.5
Session	Session number of Gen2 protocol. (set for Multi sequence and Single sequence respectively)	0 / 1 / 2 / 3	SOC/MOC - 0 SRP/MRP - 2
Mode	Communication mode	Normal / DRM	Normal

Filtering

Item	Description	The range of the set code.	Default
Condition Selection	Determines filtering condition	None / 1 / 2 / 1 and 2 / 1 or 2	(None)
Condition 1	Set value of the Condition 1		
Bank	Communication data bit length	0 to 3 (including threshold values)	(None)
Pointer	Comparison start point	0 to 255 (including threshold values).	(None)
Length	Comparison bit length	1 to 255 (including threshold values)	(None)
Data	Comparison data	Data length/ more than 1 or more and 64 or less	(None)
Condition 2	Set value of the Condition 2		
Bank	Communication data bit length	0 to 3 (including threshold values)	(None)
Pointer	Comparison start point	0 to 255 (including threshold values).	(None)
Length	Comparison bit length	1 to 255 (including threshold values)	(None)
Data	Comparison data	Hex string whose length is 1 or more and 64 or less	(None)

Smoothing

Item	Description	The range of the set code.	Default
Smoothing Buffer	Prevents rereading	0 to 999 (including threshold values)	0
Omit Response	Omits response for no tag	Disable / Enable	Disable

Action

[Apply]

To change and try the setting of the communication soon, enter the values to change and push the [Apply] button. The setting works effectively in the coming communication (but not saved). If all the applying process is finished successfully, the reader displays "Successfully Saved" in the page. Applying process is executed in the displayed order, from RF Control, Filtering to Smoothing. If saving process is succeeded, the label changes its color from black to blue. If failed, it changes to red.

[Save]

To save the changes of the communication settings, enter the values to change, push the [Apply] button, make sure applying process has complete successfully and then push the [Save] button. All the displayed values are set in the reader's nonvolatile memory. It becomes effective as a default value after booting next time.

Errors

1) Invalid Parameter(s) in [XXX]

It indicates that the data set in XXX is incorrect. (XXX will be one of RF Control, Filtering or Smoothing) In this case, correct the data and click "Save" button again.

2) Can Not Connect

It means that the host computer can not receive the data from the reader. In this case, you have to check the Ethernet connection, restart the browser and then access the reader again.

3) This Function is NOT Available Now

It means that saving process can not be executed because of reader status.

If you open this page while communicating with tag, the V750 reader displays the error message "This Function is NOT Available Now." and set [Apply] button disable. On that time, you have to stop reader's communicating process and open this page again.

Then [Apply] button is enabled and you can change the settings.

4) Unregistered Filter Condition

It means a filter selection is selected although filter condition is not set. Confirm the parameters of filter conditions.

4.2.5 Operation Settings

Function

In this page, you can see and change the operation settings, command entry and programmable output.

Screen Image

Operation Settings

Command Entry

Save

Response I/F Ethernet RS232C None

Initial Exec.	<input type="checkbox"/>	Command	
Input 1	<input checked="" type="checkbox"/>	Command	RDID -ANT 2 -TMO 100 -SEQ SOC
Input 2	<input checked="" type="checkbox"/>	Command	RDID -ANT 13 -TMO 500 -SEQ MOC
Input 3	<input type="checkbox"/>	Command	
Input 4	<input type="checkbox"/>	Command	

Programmable Output

Output 1	<input checked="" type="checkbox"/>	Function	ERR	Duration	
		Conditions			
Output 2	<input checked="" type="checkbox"/>	Function	COM	Duration	
		Conditions			
Output 3	<input checked="" type="checkbox"/>	Function	NML	Duration	5000
		Conditions	DAT==FFFF31280000		
Output 4	<input checked="" type="checkbox"/>	Function	ERC	Duration	1000
		Conditions	DAT==7172737A		

Description of Each Item

Command Entry

Item	Description	The range of the set code.	Default
Response Interface	Interface selection to send response of the command	Ethernet / RS-232C / None	Ethernet
Initial Exec (*1)	Initial command executed automatically on booting	Command characters	(None)
Input 1 (*1)	Command executed when input port 1 is activated	Command characters	(None)
Input 2 (*1)	Command executed when input port 2 is activated	Command characters	(None)
Input 3 (*1)	Command executed when input port 3 is activated	Command characters	(None)
Input 4 (*1)	Command executed when input port 4 is activated	Command characters	(None)

Programmable Output

Item	Description	The range of the set code.	Default
Output 1 (*1)	Programmable output 1 settings		
Function	Output function synchronize with this port	RUN / ERR / COM / ANT1 / ANT2 / ANT3 / ANT 4 / NML / ERC	(None)
Duration (ms) (*2)	Duration for output	0 or more and less than 9990	(None)
Condition (*2)	Condition for output (Available only when function is NML or ERC)		(None)
Output 2	Programmable output 2 settings (Setting items are the same as Output 1)		
Output 3	Programmable output 3 settings (Setting items are the same as Output 1)		
Output 4	Programmable output 4 settings (Setting items are the same as Output 1)		

*1)

To input commands and select items in the fields of the Initial Exec., Input 1-4 and Output 1-4, check ON the checkbox attached forward to each item.

*2)

Condition is active only when Function setting is selected as NML or ERC.

Action

[Save]

To change the operation setting, enter new parameter(s) and push [Save] button, then all the displayed values are saved in the reader's nonvolatile memory. It becomes effective as a default value after booting next time. All the saving process is finished successfully, the reader displays "Successfully Saved" in the page.

Saving process is executed in the displayed order, from Response I/F, Initial Exec, Input 1-4, to Output 1-4.

If saving process is succeeded, the label changes its color from black to blue. If failed, it changes to red. If the process fails to complete and stops, the latter item is not saved and it remains in black.

Errors

1) Invalid Parameter(s) in [XXX]

It indicates that the data set in XXX is incorrect. (XXX is one of the item names) In this case, correct the data and click "Save" button again.

2) Can Not Connect

It means that the host computer can not receive the data from the reader. In this case, you have to check the Ethernet connection, restart the browser and then access the reader again.

3) This Function is NOT Available Now

It means that saving process can not be executed because of reader status.

4.2.6 Communication Test

Function

You can test the command actually and see the response.
 Typical options are selectable on the screen by clicking and selecting, so even though users who don't know the command syntax and options well can generate command easily. Also users who know them well can edit any command in the text field.

Screen Image

OMRON [Firmware Update](#)

Status Reader Settings **Comm. Settings** Operation Settings Comm. Test Utility

Communication Test

Command: RDID Sequence: MOC Antenna ID: 1 Time Out: 250 Tag Info: EPC

ID: 1234567890ABCDEF12345678 Send Stop Clear

RDID -seq MOC -ant 1 -tmo 250 -tif EPC

```

[0001] RDID0000 017 FFFEEEEEDDDCCCCBBBB1041 FFFEEEEEDDDCCCCBBBB1057 300833B2DD9014035050043 F
[0002] RDID0000 018 FFFEEEEEDDD1506BBBB1031 FFFFFFFFFFFFFFFFFFFFFFFF 300833B2DD9014035050043 300
[0003] RDID0000 016 FFFEEEEEDDDCCCCBBBB1020 00000000000000000000000000000000 5A5A0000000000000000000000000000 300833
[0004] RDID0000 016 FFFEEEEEDDDCCCCBBBB1025 FFFEEEEEDDDCCCCBBBB1155 FFFEEEEEDDDCCCCBBBB1100
[0005] RDID0000 016 FFFEEEEEDDDCCCCBBBB1057 FFFEEEEEDDDCCCCBBBB1118 FFFFFFFFFFFFFFFFFFFFFFFF
[0006] RDID0000 016 FFFFFFFFFFFFFFFFFFFFFFFF FFFEEEEEDDDCCCCBBBB1057 FFFEEEEEDDDCCCCBBBB102
[0007] RDID0000 016 00000000000000000000000000000000 FFFEEEEEDDDCCCCBBBB1155 FFFEEEEEDDDCCCCBBBB1024 5A
[0008] RDID0000 016 300833B2DD901403505000D FFFEEEEEDDDCCCCBBBB1155 FFFEEEEEDDDCCCCBBBB1057 F
[0009] RDID0000 017 5A5A0000000000000000000000000000 FFFEEEEEDDDCCCCBBBB1041 FFFEEEEEDDDCCCCBBBB1024 30
[0010] RDID0000 015 FFFEEEEEDDDCCCCBBBB1024 FFFEEEEEDDDCCCCBBBB1118 FFFEEEEEDDDCCCCBBBB11
[0011] RDID0000 018 FFFEEEEEDDDCCCCBBBB1020 FFFFFFFFFFFFFFFFFFFFFFFF FFFEEEEEDDDCCCCBBBB11E
[0012] RDID0000 016 FFFEEEEEDDDCCCCBBBB1025 00000000000000000000000000000000 00000000000000000000000000000000 300833
[0013] RDID0000 018 00000000000000000000000000000000 5A5A0000000000000000000000000000 300833B2DD901403505000D 300833B
[0014] RDID0000 019 FFFEEEEEDDDCCCCBBBB1057 5A5A0000000000000000000000000000 300833B2DD9014035050043 300833B
[0015] RDID0000 016 FFFEEEEEDDDCCCCBBBB1155 300833B2DD901403505000D FFFEEEEEDDDCCCCBBBB1024 F
[0016] RDID0000 017 00000000000000000000000000000000 00000000000000000000000000000000 00000000000000000000000000000000 300833B
[0017] RDID0000 018 FFFFFFFFFFFFFFFFFFFFFFFF FFFEEEEEDDDCCCCBBBB1057 5A5A0000000000000000000000000000 300833B
[0018] RDID0000 018 FFFFFFFFFFFFFFFFFFFFFFFF 300833B2DD901403505000D FFFEEEEEDDDCCCCBBBB1020 0C
[0019] RDID0000 017 FFFFFFFFFFFFFFFFFFFFFFFF FFFEEEEEDDDCCCCBBBB1057 5A5A0000000000000000000000000000 300833B
[0020] RDID0000 018 FFFFFFFFFFFFFFFFFFFFFFFF 00000000000000000000000000000000 00000000000000000000000000000000 300833B
[0021] RDID0000 017 00000000000000000000000000000000 300833B2DD901403505000D 300833B2DD9014035050043 FFFEEEE
[0022] RDID0000 018 FFFEEEEEDDD1506BBBB1031 5A5A0000000000000000000000000000 300833B2DD9014035050043 FFFEEEE
    
```

Action

To set typical options on the command, you can select item in the pull down menu. Then command text in the command edit field is changed.

Option List

Item	Options	Note
Command	RDID / WTID	
Sequence	SOC / MOC	When only "RDID" command is selected, it can be selectable.
Antenna ID	1 / 2 / 3 / 4	
Time Out	250 / 500 / 1000 / 2000	
Tag Info.	EPC / EPC,ANT / EPC,CNT / EPC,ANT,CNT	
ID	1234567890ABCDEF12345678 / 111122223333444455556666 / AAAABBBBCCCCDDDEEEFFFFF / 87654321FEDCBA0987654321	When only "WTID" command is selected, it can be selectable.

[Send]

To customize command text as you want to use, you can edit text in the command edit field.

To execute the command written the command edit field, press the [Send] button. Then the command is executed and the response is displayed in the response text area. The response counter is put forward response.

The latest response is displayed on the top of the text area. When the newer response is received, it is added on the top of the data.

[Clear]

To clear the response text area, click [Clear] button, then the reader clears all the data of the response text area and response counter is reset to [0001].

WARNING: [Stop] button is not supported now. Please don't use it.

NOTE: Repeat sequence on RDID command (SRP, MRP) is restricted on this page. To try commands using repeat sequence, please use another communication tool.

4.2.7 Utility

The V750 reader serves 3 functions that assist you to operate it usefully.

4.2.7.1 Latest Error Logging

Function

The V750 reader displays error log data that includes command name and 4 digits error code after starting communication.

Error data is logged in order of occurrence. The latest data is displayed on [01]. The next one is on [02]. The older data is [03], [04]... The data older than 32nd is abandoned.

Screen Image

The screenshot shows the OMRON V750 reader's Utility menu. The 'Utility' tab is selected in the navigation bar. A 'Firmware Update' link is visible in the top right. The main content area is titled 'Latest Error Logging' and shows 'Updating...' in blue text. Below this are 'Start' and 'Stop' buttons. A table displays the error log data:

[01] WTID1421	[09]	[17]	[25]
[02] RDID1422	[10]	[18]	[26]
[03] RDID7C10	[11]	[19]	[27]
[04] GETR1421	[12]	[20]	[28]
[05]	[13]	[21]	[29]
[06]	[14]	[22]	[30]
[07]	[15]	[23]	[31]
[08]	[16]	[24]	[32]

Action

[Start]

To display the latest error list, press [Start] button. Then the Web page displays and updates the latest error list for the reader's communication response. While updating data, you can observe the latest errors on real time.

[Stop]

To stop obtaining the latest error list or change another page, you need to press [Stop] button.

When the reader is reset or powered down, error log is cleared.

Errors

1) Can Not Connect

It means that the host computer can not receive the data from the reader. In this case, you have to check the Ethernet connection, restart the browser and then access the reader again.

2) This Function is NOT Available Now

It means that process of getting reader status can not be executed because of reader status.

4.2.7.2 History of Error Logging

Function

The reader displays total error count for each error code after starting communication.
 It displays total command count on the middle top of the error count table.
 Errors code sorted by upper two digits and their total error counts are displayed in the table.
 The error codes that occurred once or more and their count are displayed in blue character.

Screen Image

OMRON [Firmware Update](#)

Status Reader Settings Comm. Settings Operation Settings Comm. Test Utility

History of Error Logging

Updating...

Latest Error
Error History
Noise Check

Start Stop

Command Count 497

Error Code	Count	Error Code	Count
10 Parity	0	70 Comm.	0
11 Framing	0	71 Verify	0
12 OverRun	0	7A Address	0
13 FCS	0	7B Write	0
14 Command	3	7C Antenna	1
15 Status	0	7E Lock	0
18 Frame	0	7F Tag	0
		9A System	0

Action

[Start]

To display the history of error logging, press [Start] button. Then the Web page displays and updates the history for the reader's communication response.

While updating data, you can observe the history of error log on real time.

[Stop]

To stop obtaining the history of error or change another page, you need to press [Stop] button.

The max total count is 65535. The count more than it can not be counted up.

When the reader is reset or powered down, error data is cleared.

While updating error history, you can monitor the kinds of error occurred after the reader starts communication on real time.

When the reader is reset or powered down, error count is cleared.

Errors

1) Can Not Connect

It means that the host computer can not receive the data from the reader. In this case, you have to check the Ethernet connection, restart the browser and then access the reader again.

2) This Function is NOT Available Now

It means that process of getting reader status can not be executed because of reader status.

4.2.7.3 Noise Check

Function

The reader displays the noise level shown by every two channels in bar graph.
The channel whose bar is low, it means clean status in radio wave. Higher channel shows noisy status.

Screen Image

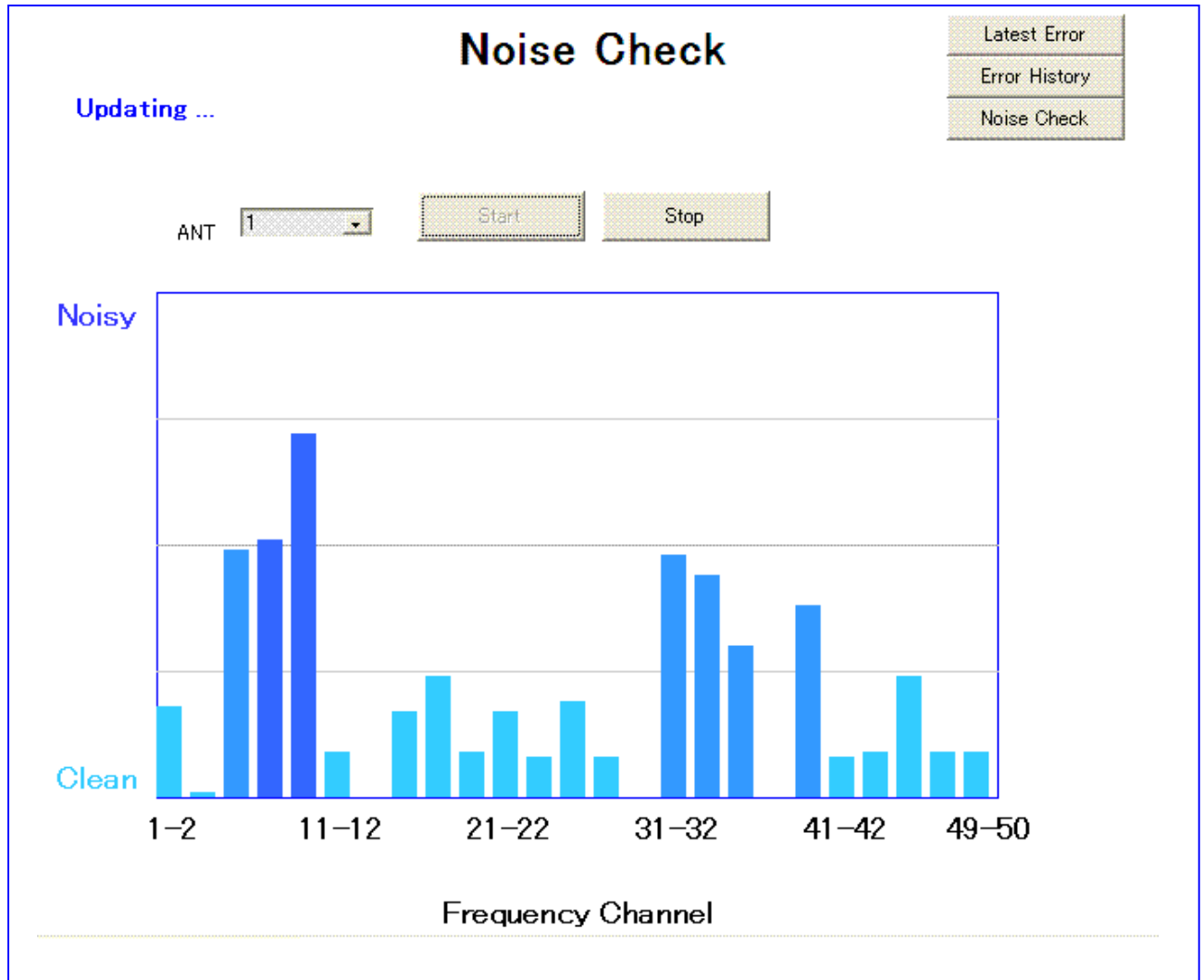

Action

[Start]

To monitor noise level, select antenna ID and press [Start] button. Then the Web page displays and updates current noise level around the indicated antenna.
While updating data, you can monitor the noise level on real time.

[Stop]

To stop monitoring noise level or change another page, you need to press [Stop] button.

Errors

1) Can Not Connect

It means that the host computer can not receive the data from the reader. In this case, you have to check the Ethernet connection, restart the browser and then access the reader again.

2) This Function is NOT Available Now

The reader is communicating with tag. After stopping communication, this function comes up to available.

4.2.8 Firmware Update

Function

The V750 reader serves the function to upgrade its firmware.
Only when new firmware file is provided from Omron, you would use it. This function should not be used in ordinary use.

Screen Image

The screenshot shows a web interface for a firmware update. At the top left is the OMRON logo. At the top right is a link labeled "Status Page". The main heading is "Firmware Update". Below this is a yellow-shaded box titled "Firmware File". Inside this box, there is a text input field, a "Browse..." button to its right, and an "Update" button below the input field. At the bottom of the page, there is a horizontal line and the text "© 2006 OMRON Corporation".

Action

To update the firmware, do the following 2 steps.

2. Indicate the firmware file for V750 reader on the PC by inputting the file path in the text field or selecting the file via file dialog displayed by [Browse...] button.
3. Press [Update] button. Then the V750 reader enters into Update Mode and starts the update process.

See Section [4.4 Update Mode] about the process after that.

WARNING: You must not indicate files except firmware file that distributed from OMRON.

4.3 Safe Mode

Safe Mode is used for confirming the essential reader settings.

You can obtain the setting information even though the reader has trouble in operation mode; for example, you can not access with Ethernet because of system error or your losing Ethernet IP address information.

On safe mode, only status page and firmware update page are available.

4.3.1 Status Page

Function

Shows the information of reader status, Ethernet and RS-232C settings. Item value is displayed as operation mode (Except Firmware Version).

Screen Image

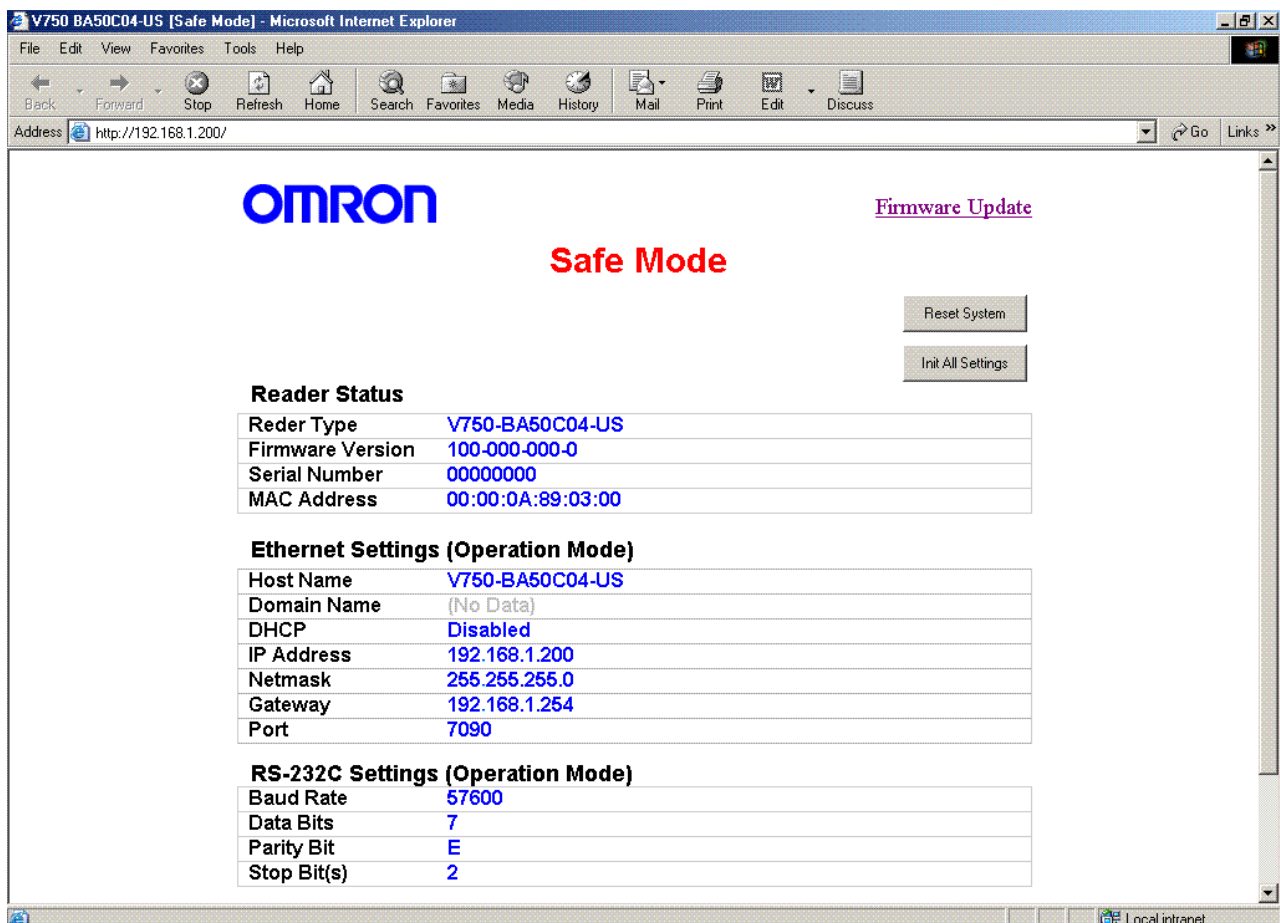

Description of Each Item

Reader Status

Item	Description	Note
Reader Type	Type name of the product V750-BA50C04-US	
Firmware Version	Firmware version currently installed in the reader. 100-000-000-0	Only the factory-default first number is displayed.
Serial Number	Unique number for product set in the factory.	
MAC Address	The reader's MAC address.	

Ethernet Settings (Operation Mode)

Item	Description
Host Name	Used to refer the host in the network
Domain Name	Name of network domain in the reader runs.
DHCP	Whether the reader uses DHCP server or not.
IP Address	The reader's IP address in the network
Subnet Mask	The reader's subnet mask in the network
Gateway	The reader's gateway address in the network
TCP/IP Port	Port number for command interface via Ethernet

RS-232C Settings (Operation Mode)

Item	Description
Baud Rate	Baud rate (bps)
Data Bits	Data bit length
Parity Bit	Parity bit
Stop Bit(s)	Count of stop bit

Action

[Reset System]

To restart the system, press [Reset System] button. After displaying message "Accept RESET. Reboot in one second." After resetting the reader, you can access the browser by clicking Reload button or opening another browser page.

[Init All Settings]

To initialize all the settings of the reader, press [Init All Settings] button. After displaying message " Accepted INIT. Reboot in one second.", all the reader's settings are initialized to factory installed settings. After initializing the reader, you can access the browser by clicking Reload button or opening another browser.

Errors

1)Can Not Connect

It means that the host computer can not receive the data from the reader. In this case, you have to check the Ethernet connection, restart the browser and then access the reader again.

4.3.2 Firmware Update Page

Function

The V750 reader serves the function to upgrade its firmware.

Screen Image

The screenshot shows a web interface for firmware updates. It includes the OMRON logo, a 'Status Page' link, a main title 'Firmware Update', a 'Firmware File' section with a text field, a 'Browse...' button, and an 'Update' button. A copyright notice '© 2006 OMRON Corporation' is at the bottom.

Action

To update the firmware, do the following 2 steps.

1. Indicate the firmware file for V750 reader on the PC by inputting the file path in the text field or selecting the file via file dialog displayed by [Browse...] button.
2. Press [Update] button. Then the V750 reader enters into Update Mode and starts the update process.

See Section [4.4 Update Mode] about the process after that.

WARNING: You must not indicate files except firmware file that distributed from OMRON.

4.4 Update Mode

It is the mode only when update process is proceeding.

While the V750 reader is on Update Mode, all the LEDs (ANT1-4) turn on.

While updating firmware, progress status is shown both web browser and LEDs of the body.

<On the web browser>

Web browser displays the updating phases. When all the process is finished, the message "All Finished. System Resets Automatically." is displayed. (Message on processing depends on firmware file.)

<On LEDs>

The LEDs of IN1-4 and OUT1-4 show the progress status. When the update process starts, the V750 reader turns off all the LEDs of IN1-4 and OUT1-4, and it lights from IN1, IN2, ... one by one. according to the status

The steps may vary depending on the firmware file.

When all the process is finished all the LEDs of IN1-4 and OUT1-4 light.

Then the V750 reader restarts 3 seconds after the message (signal) of finishing updating.

WARNING: Do NOT power off while updating firmware.

WARNING: Do NOT reload the browser after finishing or being failed update. Please close the window.

NOTE: Closing web browser before finishing updating, the update process is continued.

When all the update process is finished, web browser displays as the following.

[Status Page](#)

Firmware Update

File Transfer SUCCEEDED. Start Update Mode.

Update Started

Compatibility Check OK

Update Phase 1 OK

Update Phase 2 OK

Update Phase 3 OK

Update Phase 4 OK

All Finished. System Resets Automatically.

© 2006 OMRON Corporation

Errors

1) Illegal File Format. Confirm Update File.

You may indicate incorrect file as a firmware file. Confirm the firmware file and if the file is correct, try again after rebooting.

2) File Transfer Error. Please Restart System.

Though correct firmware file is indicated, file is broken in transferring in the network. Try again.

If update process is failed with indicating incorrect update file or another reason, LED of ERR lights and web browser displays as the following. The LEDs of IN1-4 and OUT1-4 maintains the status and it is not rebooted.

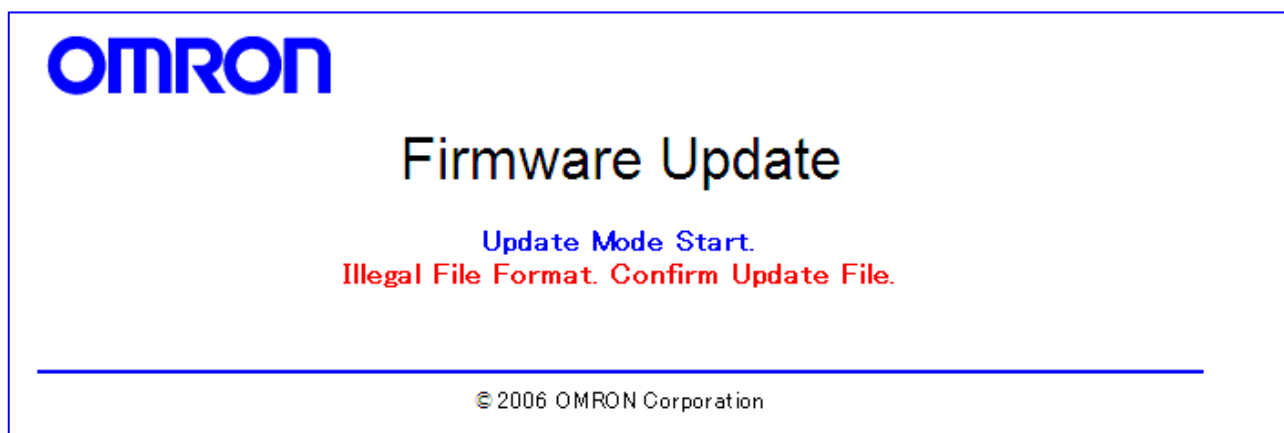

5 Communication Performance (Reference)

Characteristics data given in this chapter is provided as a guide for the user in determining suitability and does not constitute a warranty. Actual performance may vary based on actual user conditions.

5.1 Communications Range

GEN2 Tag

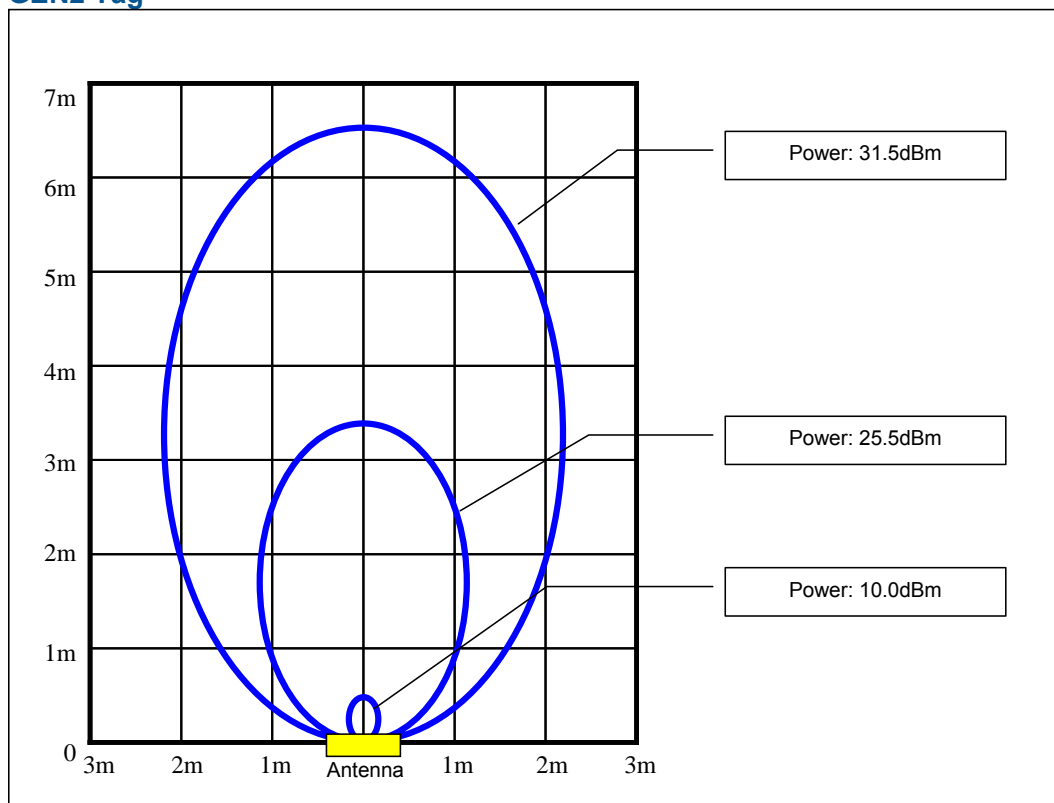

<Measurement Set-up>

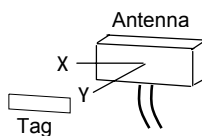

- *. There are no RF reflection objects around the Antenna and Tag in the measurement environment.
- *. There are some areas where communication is possible outside the communications range shown in the graph by the effect of reflection off of the ground. For example, radio anechoic chamber.
- *. Tag is OMRON Wave tag (V750-D22M01)
- *. GEN2:DRM off mode

5.2 Communications Time

The following charts show communication time on each mode. It is influenced on practical matters, for example, radio noise, distance between tags, materials tags are on and other environmental matters.

These charts are generated by plotting and linking average of actual communication time on every 10 tags. Communication time is measured in shielded room with one reader, so that no reflection and no interference are considered.

You can refer these charts on determining time out value of the reader command. But you must keep in mind actual communication time on your environment may not correspond to these charts because of the reasons already described.

Communication Time

[Protocol: Gen2, Sequence: Multi Read, Communication Mode: Normal]

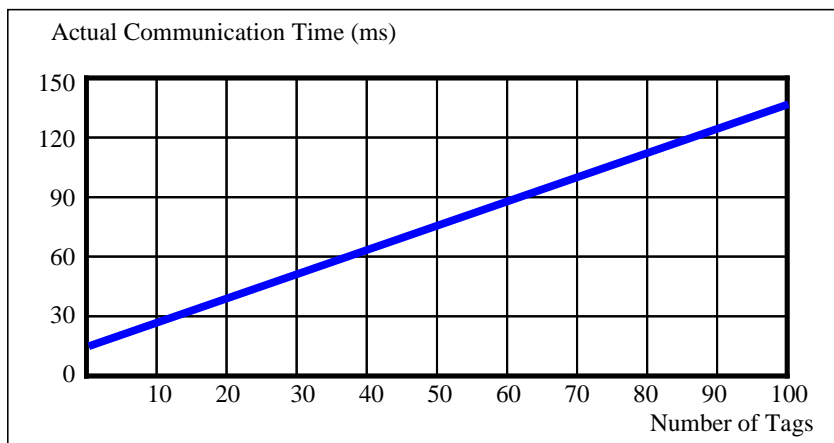

* EPC ID: 96bits

Communication Time

[Protocol: Gen2, Sequence: Multi Read, Communication Mode: DRM(Dense Reader Mode)]

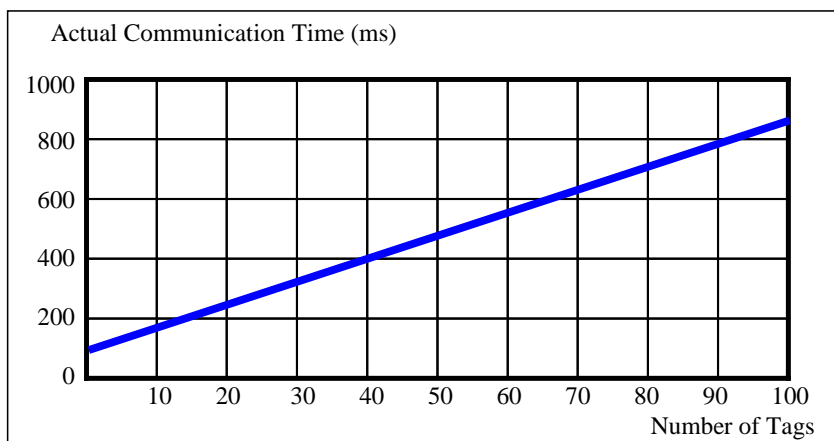

* EPC ID: 96bits

Communication Time

[Protocol: Gen2, Sequence: Single Read, Communication Mode: Normal/DRM]

Read Mode	Communication Time
Normal Mode	5ms / tag
DRM Mode	10ms / tag

* EPC ID: 96bits

Communication Time

[Protocol: Gen2, Sequence: Single Write, Communication Mode: Normal/DRM]

Write Mode	Communication Time
Normal Mode	60ms / tag
DRM Mode	100ms / tag

* EPC ID: 96bits

APPENDIX: OUTLINE DRAWINGS

Reader / Writer: (V750-BA50C04-US)

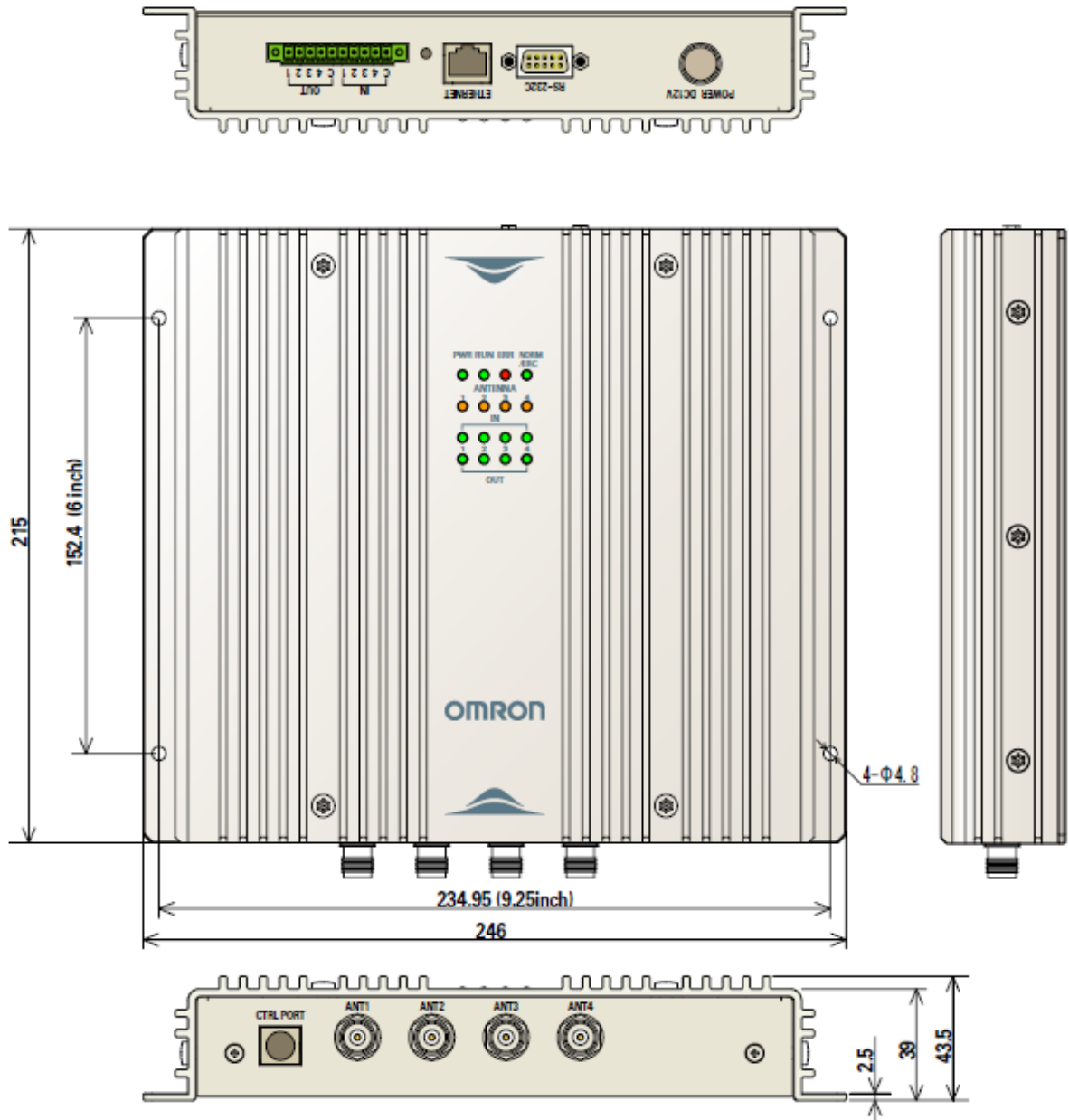

Material : Case Aluminum

Antenna: (V740-HS01CA, V740-HS01LA)

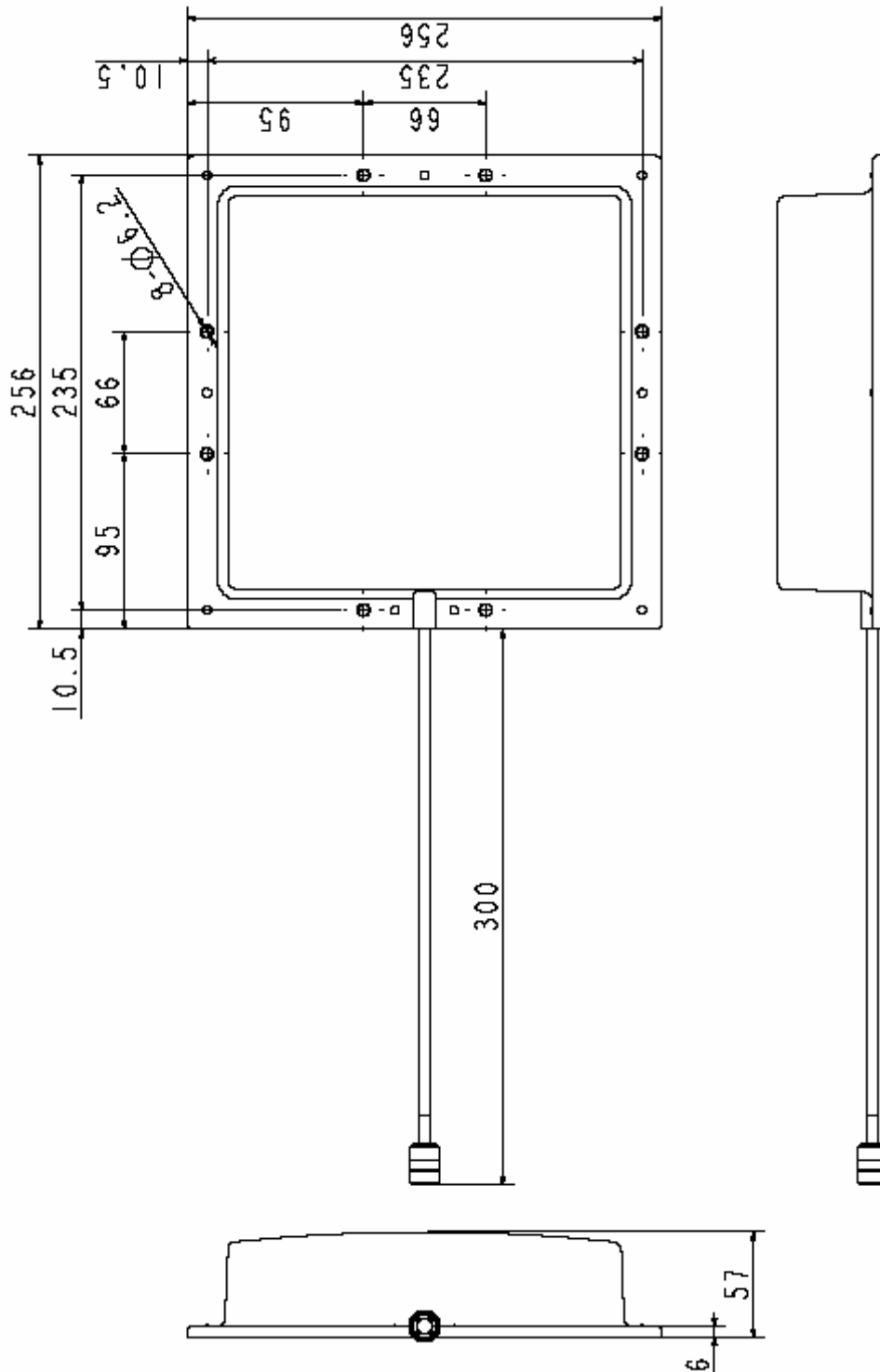

Material: Case PVC, Base plate Aluminum

Antenna Cable: (V740-A01-3.0M, V740-A01-10M)

Short cable (V740-A01-3.0M)

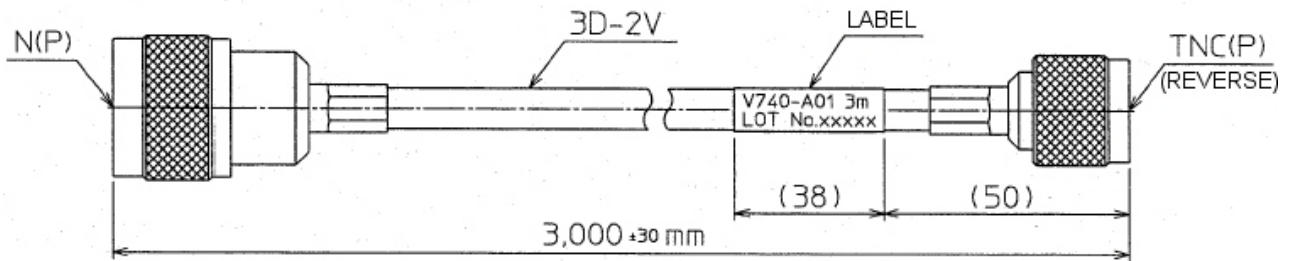

Long cable (V740-A01-10M)

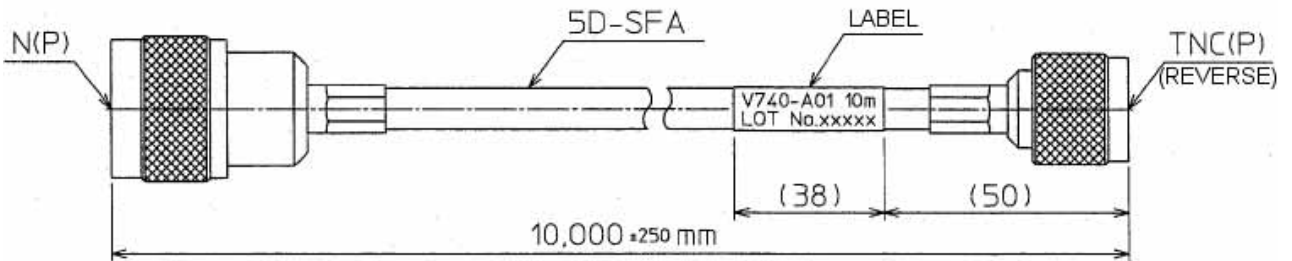

Revision History

Manual No. SRFM – 012 – A

Revision Code

Revision Code	Date	Reason for revision/revised page
A	2006/10	First edition



OMRON CORPORATION
RFID BUSINESS DEVELOPMENT DEPARTMENT
14th Fl., Gate City Osaki West Tower
1-11-1 Osaki, Shinagawa-ku,
Tokyo 141-0032 Japan
Tel: (81)3-5435-2016/Fax: (81)3-5435-2017

Regional Headquarters

OMRON ELECTRONICS LLC
1920 Thoreau Drive Suite 165 Schaumburg, IL 60173
U.S.A.
Tel: (1)847-303-0780/Fax: (1)847-925-1260

Up-to-date information on RFID Systems can be accessed at OMRON's web site at
<http://www.omronrfid.com/>