

**NTXS**

# **Programmable Terminals**

# **USER'S MANUAL**

**OMRON**

---

## Preliminary

Thank you for purchasing NTXS Series product from **Omron**. NTXS Series Products are versatile operator interfaces with Microsoft Windows® based configuration Software.

This manual will help you to **safely** install, configure and operate NTXS Products.

All the safety warnings and precautions must be followed to ensure proper unit performance and personal safety.

### Warnings used in this manual:

DANGER



Danger Warnings are used to indicate situations, ocaions and conditions that can cause serious injury or death.

CAUTION



Caution Warnings are used to indicate situations and conditions that can cause operator injury and/or unit damage.

### **If additional information or technical assistance is needed please contact:**

Omron Europe B.V.  
Wegalaan 67-69  
NL-2132 JD Hoofddorp  
The Netherlands  
Phone :(+31)23-5681300  
Fax :(+31)23 5681388  
URL: [www.omron-industrial.com](http://www.omron-industrial.com)

Manual Revisions:

**If you contact us in reference to this manual, please include the following document number:**

**Name:** NTXS Manual

**Document:** V03E-EN-02

### **IMPORTANT**

NTXS Series Products are intended to be operator interfaces, to work with PLCs which actually take control actions. It is assumed that the user is well acquainted with the PLC system being used. Never use NTXS units to perform emergency stop applications. It is advised that separate switches be used outside the PLC for ANY emergency stops.

**Any mechanical or electrical modification to the units will void all warranties.**

---

# Contents

<b><u>INTRODUCTION</u></b>	<b><u>1</u></b>
1.1 Purpose of this manual	2
1.1.1 HMI Basics	2
1.1.2 Hardware Requirements	3
1.2 NTXS Overview	4
1.2.1 What is NTXS series HMI?	4
1.3 How NTXS Works	5
1.3.1 Specifications of NTXS Series	8
<b><u>HARDWARE</u></b>	<b><u>19</u></b>
2.1 Safety Precaution	20
2.2 Installation Instructions	20
2.3 Power Requirements	22
2.4 Wiring Diagram	23
2.5 Communication Ports	23
<b><u>BEFORE YOU BEGIN</u></b>	<b><u>30</u></b>
3.1 Connecting the HMI to your Computer	31
3.2 Starting NTXS Software	32
3.2.1 Installing NTXS Software	32
3.2.2 Steps for starting NTXS Software	34
3.2.3 Uninstalling NTXS Software	35
3.3 Setting Network Configuration	35
3.3.1 Setting Network Configuration For NT2S Series Products	36
3.3.2 Setting Network Configuration For NT3S Series Products	37
<b><u>USING NTXS SOFTWARE</u></b>	<b><u>42</u></b>
4.1 NTXS Menu Structure	43
4.1.1 File Menu	45
4.1.2 Define Menu	46
4.1.3 Communicate Menu	47
4.1.4 Utilities Menu	47
4.1.5 Help Menu	48
4.2 Creating New Application	48
4.3 Creating Screens	54
4.3.1 Protecting Application Using Password	55
4.4 Data Entry Object	55
4.5 Display Data Object	56
4.6 Global And Power On Task	56
4.7 Global Keys	58
4.8 Screen Keys	59
<b><u>REPRESENTING DATA BY OBJECTS AND WIZARDS</u></b>	<b><u>60</u></b>
5.1 Alphanumeric Objects	61
5.1.1 Text Objects	61
5.1.2 Data Entry Objects	61
5.1.3 Display Data	63

---

5.1.4	Time	66
5.1.5	Date	66
5.2	Graphic Wizards	69
5.2.1	Line	69
5.2.2	Rectangle	70
5.2.3	Ellipse	70
5.2.4	Rounded Rectangle	71
5.2.5	Bargraph	71
5.2.6	Bitmap	72
5.3	Wizards	73
5.3.1	Bit Button	74
5.3.2	Word Button	78
5.3.3	Bit Lamp	81
5.3.4	Word Lamp	85
5.3.5	Multiple Bargraph	87
5.3.6	Analog Meter	93
5.3.7	Real Time Trend	98
5.3.8	Numeric Keypad	103
<b><u>TASK MANAGEMENT</u></b>		<b>108</b>
6.1	Application TaskList	109
6.2	Screen TaskList	111
6.3	Key Tasklist	113
6.3.1	For Keypad Products	113
6.3.2	For Touch screen Products	115
<b><u>USING LANGUAGES</u></b>		<b>131</b>
7.1	Export Functionality	132
7.2	Import Functionality	134
7.3	Language conversion utility	136
7.3.1	File Menu	136
7.3.2	Edit Menu	139
7.3.3	View Menu	139
7.3.4	Help Menu	139
7.4	Multi-Language Text Wizard	139
7.4.1	Configure Languages	140
7.4.2	Displaying Multiple Languages in Unit	143
<b><u>UPLOADING AND DOWNLOADING FROM UNIT</u></b>		<b>144</b>
8.1	Upload	145
8.2	Download	146
8.3	Error Catalog	147
<b><u>ALARMS</u></b>		<b>149</b>
9.1	Define Alarm	150
9.1.1	Alarm Definition	151
9.1.2	Alarm Object	152
<b><u>PRINTING</u></b>		<b>154</b>
10.1	Printing from NTXS unit	155
10.2	Printing from NTXS Software	156
<b><u>MISCELLANEOUS</u></b>		<b>158</b>

---

---

11.1	Convert Application	159
11.2	Memory Configuration Wizard	160
11.3	Font Editor	161
11.4	Image Conversion to bmp	163
<b><u>DIAGNOSTICS &amp; MAINTENANCE</u></b>		<b>165</b>
12.1	Diagnostics	166
	12.1.1 Erase Keys	166
	12.1.2 Touchscreen Calibration Loss	167
12.2	Maintenance	168
<b><u>APPENDIX</u></b>		<b>169</b>
<b>A</b>	<b>Omron Cable References and Diagrams</b>	<b>170</b>
1	Omron Cable References for connection to PLC's peripheral ports (CMOS)	170
2	Omron Cable References for connection to PLC's serial ports (RS232C) ...	170
3	Omron Cable References for Programming cable (PC to NTXS)	170
4	Omron Cable Diagrams for Serial cables	171
	4.1 NT2S-CN232-V1 / NT2S-CN235-V1	171
	4.2 NT2S-CN242-V1	172
5	Omron Cable Diagram for NT2S / NT3S Programming cable	173
	5.1 NT2S-CN002	173
6	Omron Cable Diagram for RS422 Communication cable XtraDrive and NT3S	174
<b>B</b>	<b>Non-Omron Cable Diagrams</b>	<b>175</b>
1	AB MICROLOGIX SERIES TO NTXS UNIT	175
2	AB SLC DF1 PORT TO NTXS UNIT	176
3	AROMAT FP0 / FPM TO NTXS UNIT	177
4	AROMAT FP1 TO NTXS UNIT	178
5	AROMAT FP2 TO NTXS UNIT	179
6	CONTROL TECHNIQUES TO NTXS UNIT	180
7	DANFOSS DRIVE TO NTXS UNIT	181
8	GE90 SERIES PLC TO NTXS UNIT	182
9	GE90 SERIES SNP-X PLC TO NTXS UNIT	183
10	IDEC MICRO3 TO NTXS UNIT	184
11	IDEC MICROSMART PLC TO NTXS UNIT	185
12	KEYENCE KV PLC TO NTXS UNIT	186
13	KOYO DL205 PLC TO NTXS UNIT	187
14	LG MASTER K SERIES PLC TO NTXS UNIT	188
15	MITSUBISHI FX SERIES PLC TO NTXS UNIT	189
16	MITSUBISHI FX0 PLC TO NTXS UNIT	190
17	SIEMENS STEP 7 MICRO(S7-200) PLC TO NTXS UNIT	191
18	SIEMENS-S7 300 SERIES PLC TO NTXS UNIT	192
19	TOSHIBA T1 PLC TO NTXS UNIT	193
20	TOSHIBA T2 PLC TO NTXS UNIT	194
21	TOSHIBA T1 LINK PORT TO NTXS UNIT	195
22	TOSHIBA T2 LINK PORT TO NTXS UNIT	196
23	TOSHIBA INVERTER S SERIES TO NTXS UNIT	197
24	TSX(07/37/57) PLC TO NTXS UNIT	198

---

---

	25	TWIDO PLC TO NTXS UNIT	199
C	List Of Features	200	
D	List Of Supported Devices		203
E	Technical Support	204	
<b>Index</b>	.....		<b>205</b>

## **INTRODUCTION**

In this chapter. . . .

- ◆ Purpose of this manual
  - HMI Basics
  - Hardware Configuration
  
- ◆ NTXS Overview
  - What is NTXS series HMI?
  - How NTXS works?
  - NTXS Series Specifications

## Introduction

---

### 1.1 Purpose of this manual

Thank you for purchasing NTXS Series Products from Omron. NTXS Series Products are versatile operator interfaces with Microsoft Windows based configuration Software. This manual explains the operation of the NTXS Series and how to implement available features using the NTXS Software. This manual will help you to install, configure and operate NTXS product.

#### 1.1.1 HMI Basics

Operator Interface Terminals (HMI) provide much more versatility than traditional mechanical control panels. An HMI allows a plant floor operator to monitor current conditions of a control system and, if necessary, to initiate a change in the operation of the system. HMIs connect to programmable logic controllers (PLCs) typically through the serial communications port. The HMI can be programmed to monitor and/or change current values stored in the data memory of the PLC.

HMIs can have either text-based or graphics-based displays. A text-based HMI can display printable text characters but can not print graphics.

The NTXS Series HMIs are available in both Text display based HMI and graphics display based HMIs.

What is a *Project*?

A project is a user created application in NTXS Software. A project contains information such as NTXS model, Network Configuration, Screen information, Task information etc.

What is a *Screen*?

A screen is a visual representation of objects placed on the HMI screen. Any partially sized window is usually referred to as a popup screen or window. User can create his customized screen according to his requirements. Popup windows can also appear on the HMI display by pressing buttons on the touch screen. Maximum number of screens in an application is limited by the application memory size. A more in depth discussion on screen is covered in chapter 4.

What is an *Object*?

An object placed on HMI screen can perform actions such as displaying text messages, writing value to PLC register, or displaying an alarm on HMI screen etc. An object can be classified as Text object and Graphical object.

For example, a Text Object is used to display text on the HMI. But objects are also used to configure the HMI to perform some action. For example, a Display Data Object tells the HMI to continuously monitor a PLC register that is used by the PLC. Some objects can display a graphics shape on the HMI screen and perform some action. A Bit Button Object creates a graphic object on the HMI that when pressed, activates a bit in the PLC.



### 1.1.2 Hardware Requirements

The following basic PC hardware configuration is needed to configure and operate your NTXS Software.

DEVICE	MINIMUM REQUIREMENT
IBM Compatible PC with	266 MHz Pentium® II or higher Pentium
Pentium Processor	compatible CPU
Operating System	Windows® 2000 and above
System RAM	At least 64 megabytes (MB) of RAM, more memory generally improves responsiveness
Hard Disk	150 MB Free Memory Space
VGA Monitor Color Setting Resolution	800 x 600 with 24 bit True Color
Serial Port	Serial Port for Downloading
Mouse	Microsoft® Mouse or compatible pointing device
Keyboard	Required

These are the minimum system requirements for running the NTXS application.

# Introduction

---

## 1.2 NTXS Overview

### 1.2.1 What is NTXS series HMI?

NTXS Series operator interfaces provide Human-Machine Interface to the Programmable Logic Controller. The HMIs communicate with PLCs using their serial communications ports.

Configuration of NTXS:

Each NTXS unit has to be configured using the NTXS Software before connecting it to the PLC.

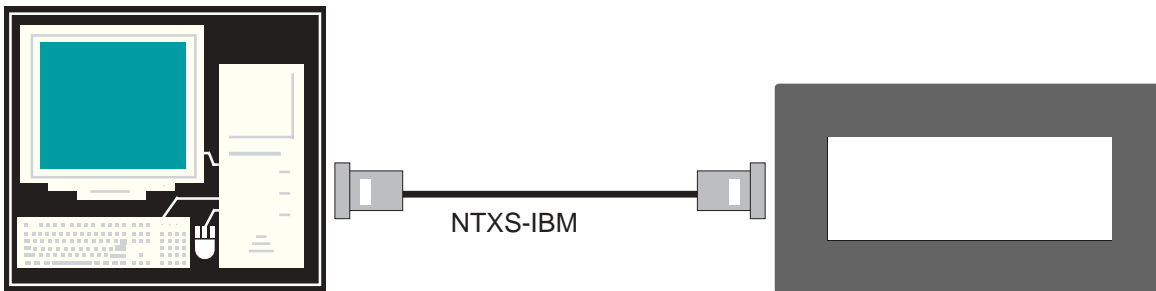

Normal Operation:

After configuration is completed, NTXS should be connected with a PLC to start the system.

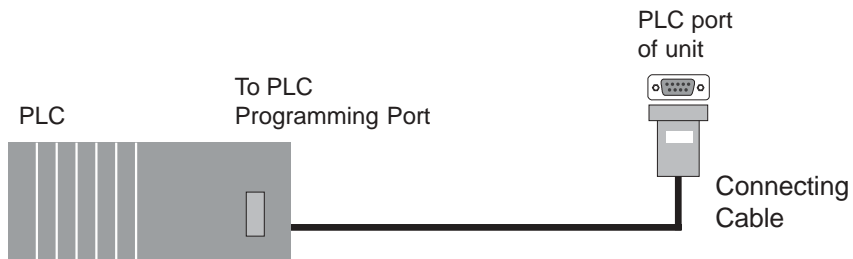

### 1.3 How NTXS Works

The NTXS follows a specific sequence for performing the tasks defined by the user in the application. The sequence is as shown below

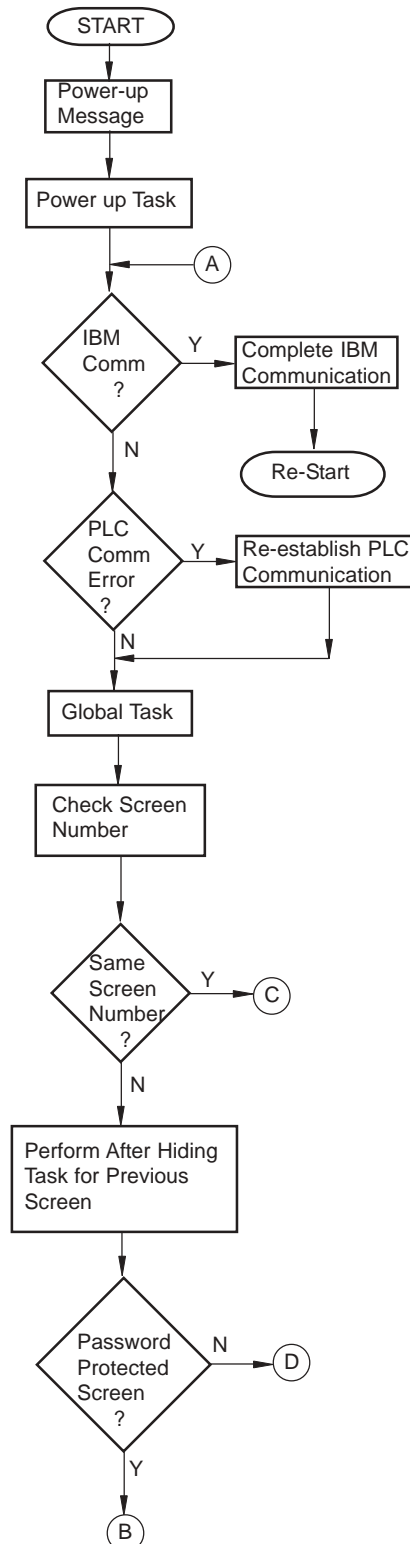

# Introduction

---

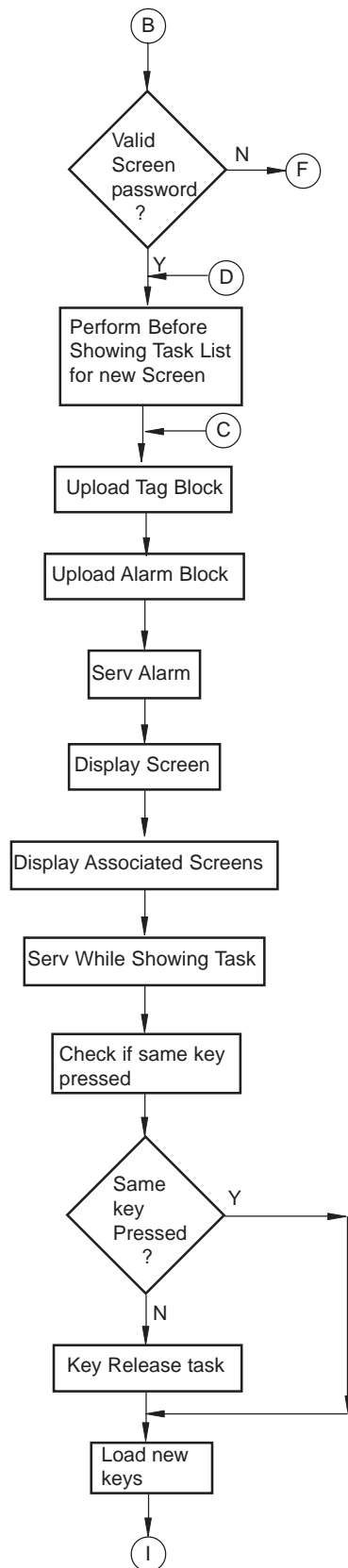

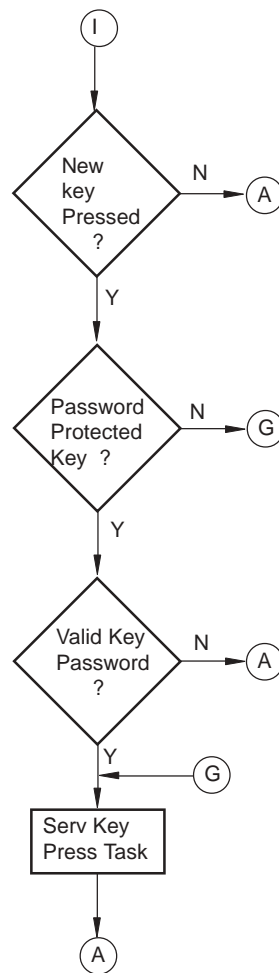

## Introduction

---

### 1.3.1 Specifications of NTXS Series

Models included in the NTXS series are as follows:

NT2S-SF121B-EV2  
NT2S-SF122B-EV2  
NT2S-SF123B-EV2

NT2S-SF125B-E  
NT2S-SF126B-E  
NT2S-SF127B-E

NT3S-ST121B-E  
NT3S-ST123B-E  
NT3S-ST124B-E  
NT3S-ST126B-E

## NT2S-SF121B-EV2

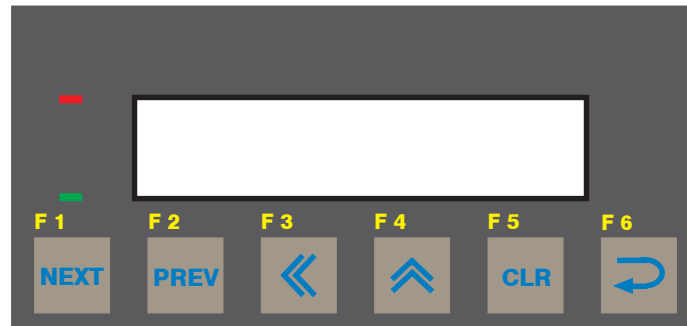

<b>Power Supply</b>	24VDC	<b>Miscellaneous</b>	
Voltage Rating	24 VDC $\pm$ 10%	Dimension	92.00 X 45.00 mm
Power Rating	1.5W	Battery	Coin Type, 3V Lithium Battery 614-CR1225FH
<b>Approvals</b>	CE, CSA and cULus Class 1 Div.2 Certified	Battery Backup	8 years typical battery backup for RTC and System data
<b>Bezel</b>	IP65 Rated Keypad	Operating Temperature	0 °C to 50 °C
<b>Keypad</b>	Membrane Keypad With Tactile Feedback Keys	Storage Temperature	-25 °C to 80 °C
Number Of Keys	6 user Definable keys	Mounting Method	Panel Mounting
<b>Memory</b>		Clock(RTC)	Real Time Clock Function(Date & Time)
Total Memory	63KB	Humidity	10% To 90% (Noncondensing)
Application Memory	24KB	Immunity to ESD	Level 3 as per IEC1000-4-2
Data Register	1000	Immunity to Transients	Level 3 as per IEC1000-4-4
Retentive Register	1000	Immunity to Radiated RF	Level 3 as per IEC1000-4-3
<b>Display</b>	LCD Text Display	Emission	EN55011 CISPR A
Display Type	2 lines of 16 characters Backlit LCD		
LEDs	2 LEDs		
<b>Communication</b>			
Number of Ports	2		
Type	One RS232/CMOS port for connecting to PLC and one RS232 port for programming and printing		

**System Components:**

- Unit with LCD display, Membrane keypad and RTC.
- Power Supply connector.
- Installation Kit: Gasket, Two Mounting clamps

*Note: User should order cables separately*

## Introduction

### NT2S-SF122B-EV2

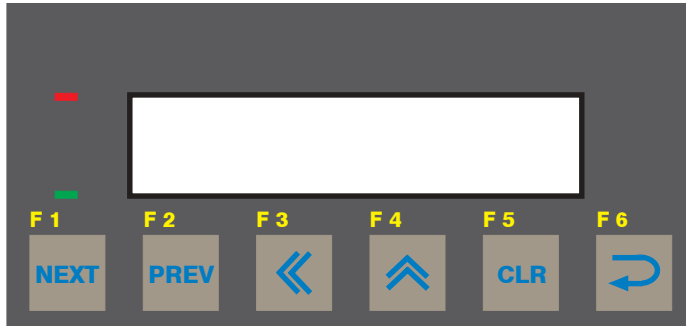

<b>Power Supply</b>	5VDC
Voltage Rating	5 VDC $\pm$ 10% from PLC
<b>Approvals</b>	CE, CSA and cULus Class 1 Div.2 Certified
<b>Bezel</b>	IP65 Rated Keypad
<b>Keypad</b>	Membrane Keypad With Tactile Feedback Keys
Number Of Keys	6 user Definable keys
<b>Memory</b>	
Total Memory	63KB
Application Memory	24KB
Data Register	1000
Retentive Register	1000
<b>Display</b>	LCD Text Display
Display Type	2 lines of 16 characters Backlit LCD
LEDs	2 LEDs
<b>Communication</b>	
Number of Ports	2
Type	One RS232/CMOS port for connecting to PLC and one RS232 port for programming and printing

<b>Miscellaneous</b>	
Dimension	92.00 X 45.00 mm
Operating Temperature	0 °C to 50 °C
Storage Temperature	-25 °C to 80 °C
Mounting Method	Panel Mounting
Humidity	10% To 90% (Noncondensing)
Immunity to ESD	Level 3 as per IEC1000-4-2
Immunity to Transients	Level 3 as per IEC1000-4-4
Immunity to Radiated RF	Level 3 as per IEC1000-4-3
Emission	EN55011 CISPRA

#### System Components:

- Unit with LCD display, Membrane keypad
- Installation Kit: Gasket, Two Mounting clamps

*Note: User should order cables separately*



## NT2S-SF123B-EV2

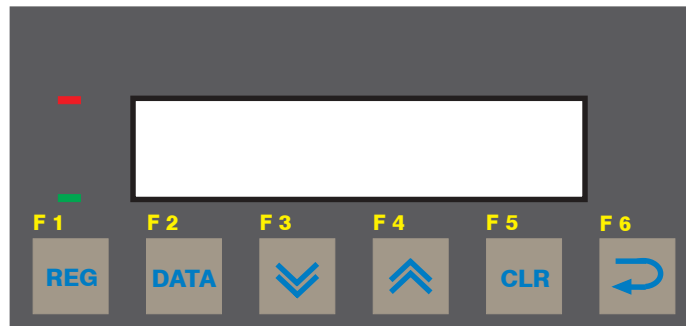

<b>Power Supply</b>	5VDC	<b>Miscellaneous</b>	
Voltage Rating	5 VDC $\pm$ 10% from PLC	Dimension	92.00 X 45.00 mm
<b>Approvals</b>	CE, CSA and cULus Class 1 Div.2 Certified	Operating Temperature	0 °C to 50 °C
		Storage Temperature	-25 °C to 80 °C
<b>Bezel</b>	IP65 Rated Keypad	Mounting Method	Panel Mounting
<b>Keypad</b>	Membrane Keypad With Tactile Feedback Keys	Humidity	10% To 90% (Noncondensing)
Number Of Keys	6 keys	Immunity to ESD	Level 3 as per IEC1000-4-2
<b>Display</b>	LCD Text Display	Immunity to Transients	Level 3 as per IEC1000-4-4
Display Type	2 lines of 16 characters Backlit LCD	Immunity to Radiated RF	Level 3 as per IEC1000-4-3
LEDs	2 LEDs	Emission	EN55011 CISPR A
<b>Communication</b>			
Number of Ports	1		
Type	CMOS port for communication to PLC		

System Components:

- Unit with LCD display, Membrane keypad
- Installation Kit: Gasket, Two Mounting clamps

*Note: User should order cables separately*

## Introduction

### NT2S-SF125B-E

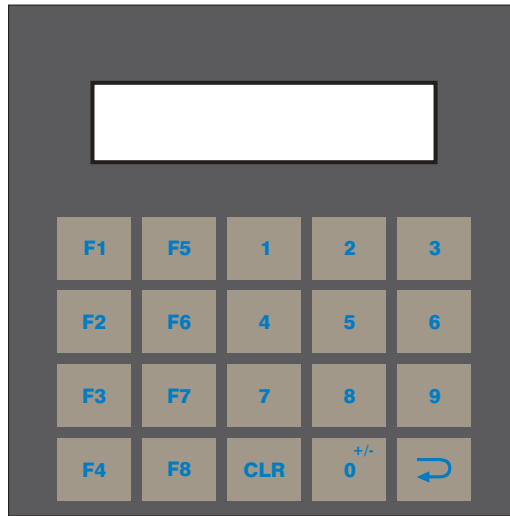

<b>Power Supply</b>	24VDC
Voltage Rating	24 VDC $\pm$ 10%
Power Rating	1.5W
<b>Approvals</b>	CE and cULus Class1 Div. 2 Certified
<b>Bezel</b>	IP65 Rated Keypad
<b>Keypad</b>	PCB based Keypad With Tactile Feedback Keys
Number Of Keys	20 keys
<b>Memory</b>	
Total Memory	63KB
Application Memory	24KB
Data Register	1000
Retentive Register	1000
<b>Display</b>	LCD Text Display
Display Type	2 lines of 16 characters Backlit LCD
<b>Communication</b>	
Number of Ports	2
Type	One RS232/CMOS port for connecting to PLC and one RS232 port for Programming and Printing

<b>Dimension</b>	92.00 X 92.00 mm
Battery	Coin Type, 3V Lithium Battery 614-CR1225FH
Battery Backup	8 years typical battery backup for RTC and System data
Operating Temperature	0 °C to 50 °C
Storage Temperature	-25 °C to 80 °C
Mounting Method	Panel Mounting
Clock(RTC)	Real Time Clock Function (Date & Time)
Humidity	10% To 90% (Noncondensing)
Immunity to ESD	Level 3 as per IEC1000-4-2
Immunity to Transients	Level 3 as per IEC1000-4-4
Immunity to Radiated RF	Level 3 as per IEC1000-4-3
Emission	EN55011 CISPR A

#### System Components:

- Unit with LCD display, Membrane keypad and RTC.
- Power Supply connector.
- Installation Kit: Gasket, Two Mounting clamps

*Note: User should order cables separately*

## NT2S-SF126B-E



<b>Power Supply</b>	5VDC	<b>Miscellaneous</b>	
Voltage Rating	5 VDC $\pm$ 10% from PLC	Dimension	92.00 X 92.00 mm
<b>Approvals</b>	CE and cULus Class1 Div. 2 Certified	Operating Temperature	0 °C to 50 °C
		Storage Temperature	-25 °C to 80 °C
<b>Bezel</b>	IP65 Rated Keypad	Mounting Method	Panel Mounting
<b>Keypad</b>	PCB based Keypad With Tactile Feedback Keys	Clock(RTC)	Does not support RTC
Number Of Keys	20 User definable keys	Humidity	10% To 90% (Noncondensing)
<b>Memory</b>		Immunity to ESD	Level 3 as per IEC1000-4-2
Total Memory	63KB	Immunity to Transients	Level 3 as per IEC1000-4-4
Application Memory	24KB	Immunity to Radiated RF	Level 3 as per IEC1000-4-3
Data Register	1000	Emission	EN55011 CISPR A
Retentive Register	1000		
<b>Display</b>	LCD Text Display		
Display Type	2 lines of 16 characters Backlit LCD		
<b>Communication</b>			
Number of Ports	2		
Type	One RS232/CMOS port for connecting to PLC and one RS232 port for Programming and Printing		

**System Components:**

- Unit with LCD display, Membrane keypad
- Installation Kit: Gasket, Two Mounting clamps

*Note: User should order cables separately*

## Introduction

### NT2S-SF127B-E



<b>Power Supply</b>	5VDC	<b>Miscellaneous</b>	
Voltage Rating	5 VDC $\pm$ 10% from PLC	Dimension	92.00 X 92.00 mm
<b>Approvals</b>	CE and cULus Class1 Div.2 Certified	Operating Temperature	0 °C to 50 °C
		Storage Temperature	-25 °C to 80 °C
<b>Bezel</b>	IP65 Rated Keypad	Mounting Method	Panel Mounting
<b>Keypad</b>	PCB based Keypad With Tactile Feedback Keys	Clock(RTC)	Does not support RTC
Number Of Keys	20 keys	Humidity	10% To 90% (Noncondensing)
<b>Display</b>	LCD Text Display	Immunity to ESD	Level 3 as per IEC1000-4-2
Display Type	2 lines of 16 characters Backlit LCD	Immunity to Transients	Level 3 as per IEC1000-4-4
		Immunity to Radiated RF	Level 3 as per IEC1000-4-3
		Emission	EN55011 CISPR A
<b>Communication</b>			
Number of Ports	1		
Type	CMOS port for connecting to PLC		

#### System Components:

- Unit with LCD display, Membrane keypad
- Installation Kit: Gasket, Two Mounting clamps

*Note: User should order cables separately*

**NT3S-ST121B-E**

<b>Power Supply</b>	24VDC
Voltage Rating	24 VDC $\pm$ 10%
Power Rating	3.5W
<b>Approvals</b>	CE and cULus Class 1 Div. 2 Certified
<b>Bezel</b>	IP65 Rated
<b>Memory</b>	
Total Memory	512KB
Application Memory	120KB
Data Register	1000
Retentive Register	1000
System Register	64
System Coil	100
Internal Coil	5000
<b>Display</b>	LCD Graphic Display
Display Type	Monochrome Backlit LCD Display
Display Resolution	192 X 64 Pixels
Touch Screen	4 wire, Analog Resistive
<b>Communication</b>	
Number of Ports	2
Type	RS232/CMOS/RS485/RS422 for connecting to PLC, Programming and Printing



<b>Miscellaneous</b>	
Dimension	132.00 X 69.00 mm
Battery	Coin Type, 3V Lithium Battery 614-CR1225FH
Battery Backup	8 years typical battery backup for RTC and System data
Operating Temperature	0 °C to 50 °C
Storage Temperature	-25 °C to 80 °C
Mounting Method	Panel Mounting
Clock(RTC)	Real Time Clock Function (Date & Time)
Humidity	10% To 90% (Noncondensing)
Immunity to ESD	Level 3 as per IEC1000-4-2
Immunity to Transients	Level 3 as per IEC1000-4-4
Immunity to Radiated RF	Level 3 as per IEC1000-4-3
Emission	EN55011 CISPR A

**System Components:**

- Unit with LCD display, touch screen and RTC
- Power Supply connector.
- Installation Kit: Gasket, Two Mounting clamps

*Note: User should order cables separately*

## Introduction

### NT3S-ST123B-E

<b>Power Supply</b>	24VDC
Voltage Rating	24 VDC $\pm$ 10%
Power Rating	3.5W
<b>Approvals</b>	CE and cULus Class 1 Div. 2 Certified
<b>Bezel</b>	IP65 Rated
<b>Memory</b>	
Total Memory	512KB
Application Memory	120KB
Data Register	1000
Retentive Register	1000
System Register	64
System Coil	100
Internal Coil	5000
<b>Display</b>	LCD Graphic Display
Display Type	Monochrome Backlit LCD Display
Display Resolution	192 X 64 Pixels
Touch Screen	4 wire, Analog Resistive
<b>Communication</b>	
Number of Ports	2
Type	One RS232/CMOS/RS485/RS422 and one RS232/CMOS for connecting to PLC, Programming and Printing



<b>Miscellaneous</b>	
Dimension	132.00 X 69.00 mm
Battery	Coin Type, 3V Lithium Battery 614-CR1225FH
Battery Backup	8 years typical battery backup for RTC and System data
Operating Temperature	0 °C to 50 °C
Storage Temperature	-25 °C to 80 °C
Mounting Method	Panel Mounting
Clock(RTC)	Real Time Clock Function (Date & Time)
Humidity	10% To 90% (Noncondensing)
Immunity to ESD	Level 3 as per IEC1000-4-2
Immunity to Transients	Level 3 as per IEC1000-4-4
Immunity to Radiated RF	Level 3 as per IEC1000-4-3
Emission	EN55011 CISPRA

#### System Components:

- Unit with LCD display, touch screen and RTC
- Power Supply connector.
- Installation Kit: Gasket, Two Mounting clamps

*Note: User should order cables separately*

**NT3S-ST124B-E**

<b>Power Supply</b>	24VDC
Voltage Rating	24 VDC $\pm$ 10%
Power Rating	3.5W
<b>Approvals</b>	CE and cULus Class 1 Div. 2 Certified
<b>Bezel</b>	IP65 Rated
<b>Memory</b>	
Total Memory	512KB
Application Memory	120KB
Data Register	1000
Retentive Register	1000
System Register	64
System Coil	100
Internal Coil	5000
<b>Display</b>	LCD Graphic Display
Display Type	Monochrome Backlit LCD Display
Display Resolution	192 X 64 Pixels
Touch Screen	4 wire, Analog Resistive
<b>Communication</b>	
Number of Ports	2
Type	One RS232/CMOS/RS485/RS422 and One RS232/CMOS port for connecting to PLC, Programming and Printing



<b>Miscellaneous</b>	
Dimension	132.00 X 69.00 mm
Operating Temperature	0 °C to 50 °C
Storage Temperature	-25 °C to 80 °C
Mounting Method	Panel Mounting
Clock(RTC)	Does not support RTC
Humidity	10% To 90% (Noncondensing)
Immunity to ESD	Level 3 as per IEC1000-4-2
Immunity to Transients	Level 3 as per IEC1000-4-4
Immunity to Radiated RF	Level 3 as per IEC1000-4-3
Emission	EN55011 CISPR A

**System Components:**

- Unit with LCD display, touch screen
- Power Supply connector.
- Installation Kit: Gasket, Two Mounting clamps

*Note: User should order cables separately*

## Introduction

### NT3S-ST126B-E

<b>Power Supply</b>	24VDC
Voltage Rating	24 VDC $\pm$ 10%
Power Rating	3.5W
<b>Approvals</b>	CE and cULus Class 1 Div. 2 Certified
<b>Bezel</b>	IP65 Rated
<b>Memory</b>	
Total Memory	512KB
Application Memory	120KB
Data Register	1000
Retentive Register	1000
System Register	64
System Coil	100
Internal Coil	5000
<b>Display</b>	LCD Graphic Display
Display Type	Monochrome Backlit LCD Display
Display Resolution	192 X 64 Pixels
Touch Screen	4 wire, Analog Resistive
<b>Communication</b>	
Number of Ports	2
Type	RS232/CMOS for connecting to PLC, Programming and Printing



<b>Miscellaneous</b>	
Dimension	132.00 X 69.00 mm
Operating Temperature	0 °C to 50 °C
Storage Temperature	-25 °C to 80 °C
Mounting Method	Panel Mounting
Clock(RTC)	Does not support RTC
Humidity	10% To 90% (Noncondensing)
Immunity to ESD	Level 3 as per IEC1000-4-2
Immunity to Transients	Level 3 as per IEC1000-4-4
Immunity to Radiated RF	Level 3 as per IEC1000-4-3
Emission	EN55011 CISPR A

#### System Components:

- Unit with LCD display, touch screen
- Power Supply connector.
- Installation Kit: Gasket, Two Mounting clamps

*Note: User should order cables separately*



## HARDWARE

In this chapter. . . .

- ◆ Safety Precautions
- ◆ Installation Instructions
- ◆ Power Requirements
- ◆ Wiring Diagram
- ◆ Communication Ports

## Hardware

---

### 2.1 Safety Precaution

Please observe the following precautions when installing the unit. Failure to comply with these restrictions could result in loss of life, serious personal injury, or equipment damage.



**Warning:** Do not operate the HMI in areas subject to explosion due to flammable gases, vapors, or dusts.



**Warning:** Do not connect the HMI to an AC power source. You will cause permanent damage to the HMI.



**Warning:** Do not attempt to use a DC power supply that does not meet HMI power requirements. You may cause malfunction or permanent damage to HMI.



**Warning:** Do not power the HMI with a DC power supply used for inductive loads or for input circuitry to the programmable logic controller. Severe voltage spikes caused by these devices may damage the HMI.

### 2.2 Installation Instructions

The NTXS should be mounted on a panel. Gasket, mounting clamps are provided with each NTXS unit for proper mounting.

#### Environmental Considerations:

Make sure that the unit is installed correctly and that the operating limits are followed (see Specifications for NTXS).

Do not operate NTXS in areas subject to explosion hazards due to flammable gases, vapors or dusts. NTXS should not be installed where fast temperature variations are present. Highly humid areas are also to be avoided. High humidity causes condensation of water in the unit.

#### Location Considerations:

Care should be taken when locating equipment behind the NTXS to ensure that AC power wiring, PLC output modules, contactors, starters, relays and any other source of electrical interference are located away from NTXS. Particular care should be taken to the position of Variable speed drives and switching power supplies away from the NTXS.

#### Panel Mounting

This section presents the dimensional sketches and panel cutouts for NTXS models.  
(All dimensions are in mm. Not to Scale.)

**NT2S-SF121B-EV2, NT2S-SF122B-EV2 and NT2S-SF123B-EV2**

Panel cutout: 92.00 mm x 45.00 mm

All Dimensions are in mm.

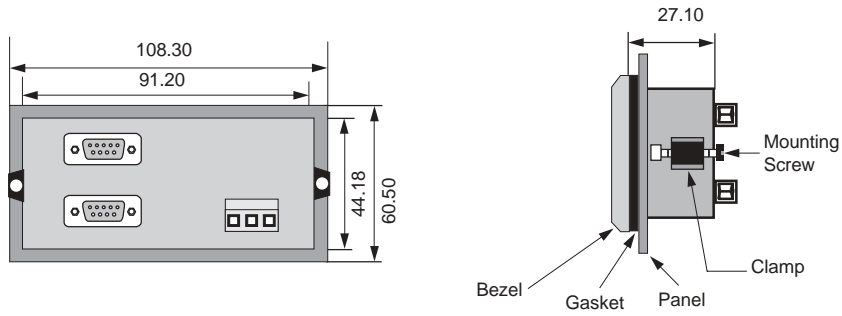

**NT2S-SF125B-E, NT2S-SF126B-E and NT2S-SF127B-E**

Panel Cutout: 92.00 mm x 92.00 mm

All Dimensions are in mm.

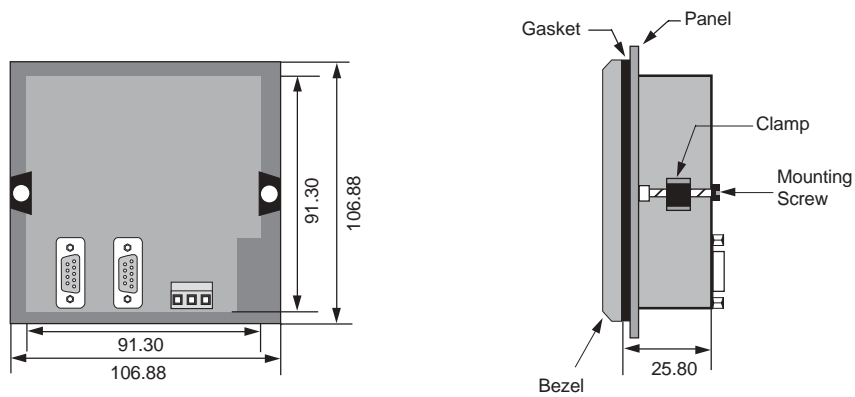

**NT3S-ST121B-E, NT3S-ST123B-E, NT3S-ST124B-E and NT3S-ST126B-E**

Panel cutout: 132.00 mm x 69.00 mm

All Dimensions are in mm.

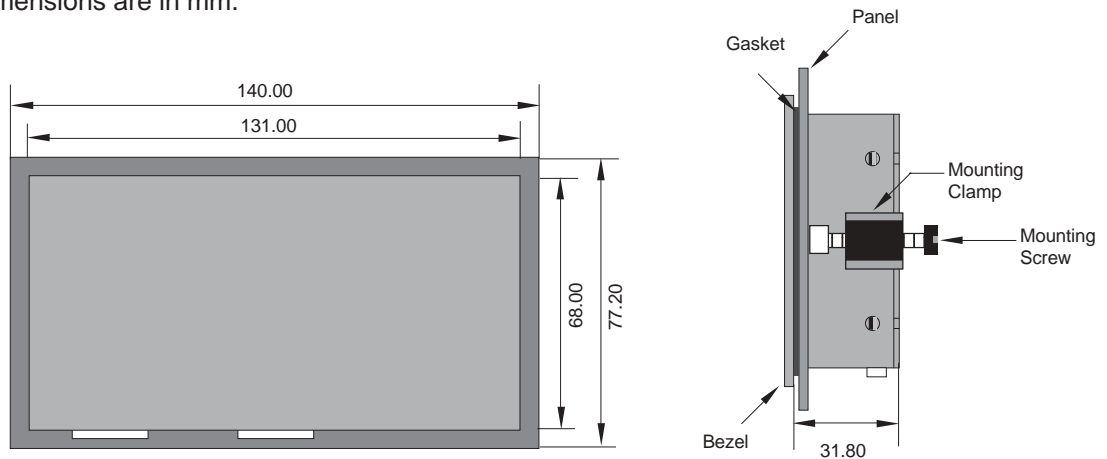

## Hardware

---

### 2.3 Power Requirements

Supply voltage requirements for NTXS series models is as follows:

NT2S-SF121B-EV2	+24VDC $\pm$ 10%, 1.5W maximum on Power Port
NT2S-SF122B-EV2	+5VDC $\pm$ 10% on PLC port
NT2S-SF123B-EV2	+5VDC $\pm$ 10% on PLC port
NT2S-SF125B-E	+24VDC $\pm$ 10%, 1.5W maximum on Power Port
NT2S-SF126B-E	+5VDC $\pm$ 10% on PLC port
NT2S-SF127B-E	+5VDC $\pm$ 10% on PLC port
NT3S-ST121B-E	+24VDC $\pm$ 10%, 3.5W maximum on Power Port
NT3S-ST123B-E	+24VDC $\pm$ 10%, 3.5W maximum on Power Port
NT3S-ST124B-E	+24VDC $\pm$ 10%, 3.5W maximum on Power Port
NT3S-ST126B-E	+24VDC $\pm$ 10%, 3.5W maximum on Power Port

Please follow the instructions given below while making power supply connections for models:

1. Follow the wiring diagram on the sticker of the unit which shows terminals.
2. To make a connection strip about 7mm of insulation of the wire, turn the connector screw counter-clock wise until the gap is wide open. Insert the wire all the way in and turn the screw clockwise until it is tight.
3. Wire lengths should be minimum. Wires should run in pairs with a neutral or common paired with a live or signal wire.
4. NTXS +24VDC model is fused internally with a self resetting 60V, 400mA fuse. It is recommended that all input power lines be protected from product failure by a fuse or breaker.
5. Adequate strain relief must be provided for the power connector, to ensure that vibration does not cause the power connector to be pulled out.
6. All the NTXS products are housed in a moulded ABS plastic case which eliminates any electrical shock hazard. Hence Safety Earth is not required to be connected to the chassis of the unit.
7. The DC ground is not directly coupled to Earth ground internally. The unit is designed to operate properly whether or not the DC ground is connected to the Earth ground. We do recommend, however, that if the DC ground has to be connected to the Earth ground, the Earth connection should be made to a central star point as poor site earths can introduce noise into a system.
8. Do not power unit and inductive loads with the same power supply even though there is enough immunity in the NTXS to withstand the transients present on these lines. Avoid using power supplies with large capacitive outputs which may cause problems if power is cycled within a short time period.
9. If wiring is to be exposed to lightening or surges, use appropriate surge suppression devices.
10. Keep AC, high energy and rapidly switching DC wiring separate from signal wires.
11. Connecting high voltages or AC power mains to the DC input will make unit unusable and may create an electrical shock hazard to personnel. Such a failure or shock could result in serious personal injury, loss of life and/or equipment damage. DC voltage sources should provide proper isolation from main AC power and similar hazards.

## 2.4 Wiring Diagram

If wiring is to be exposed to lightening or surges, use appropriate surge suppression devices. Keep AC, high energy and rapidly switching DC wiring separate from signal wires. Connecting high voltages or AC power mains to the DC input will make unit unusable and may create an electrical shock hazard to personnel. Such a failure or shock could result in serious personal injury, loss of life and/or equipment damage. DC voltage sources should provide proper isolation from main AC power and similar hazards.

Pin description of the power connector for NTXS Models is as follows:

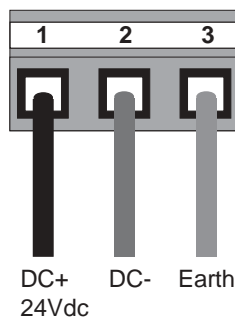

## 2.5 Communication Ports

NTXS unit has 2 types of communication ports.

One port of NT2S models has RS232/CMOS signals. This port is used to connect to PLC. The other port has RS232 signals which is used for receiving configuration setup and printing.

**Note:** NT2S-SF123B-EV2 and NT2S-SF127B-E units have only a PLC port with CMOS signals.

NT3S has multi-signal ports meaning RS232/RS485/CMOS signal level ports.

**Note:** NT3S-ST126B-E unit has only RS232 and CMOS signal level ports.

NT3S units can simultaneously communicate with two devices on these serial ports. Units can receive data from PC on either of the ports. Both the ports are also capable of Serial Printing. Each port has to be configured for their function. Even if both the ports are configured for PLC connection, user can download data from NTXS software on either of the ports. For Programming cable details, please refer to Appendix.

Different cables are required for different devices. Cable details for any particular device are given in the Operation Manual of that device. Pin description of the communication Ports for NT2S and NT3S models is as given in following pages.

## Hardware

---

### NT3S-ST121B-E

Com1 and Com2 Ports

Port Type: DB9 Female

Pin Number	Name	Description
1	TX+	Transmit +
2	232TXD	Transmit 232
3	RXD	Receive 232 / CMOS
4	RX+	Receive +
5	GND	Circuit Ground
6	VCC	+5 VDC
7	CMOSTXD	Transmit CMOS
8	TX-	Transmit -
9	RX-	Receive -

### NT3S-ST123B-E / NT3S-ST124B-E

Com1 Port

Port Type: DB9 Female

Pin Number	Name	Description
1	TX+	Transmit +
2	232TXD	Transmit 232
3	RXD	Receive 232 / CMOS
4	RX+	Receive +
5	GND	Circuit Ground
6	VCC	+5 VDC
7	CMOSTXD	Transmit CMOS
8	TX-	Transmit -
9	RX-	Receive -

**NT3S-ST123B-E / ST124B-E**

Com2 Port  
 Port Type: DB9 Female

Pin Number	Name	Description
1	NC	NC
2	232TXD	Transmit 232
3	RXD	Receive 232 / CMOS
4	NC	NC
5	GND	Circuit Ground
6	VCC	+5 VDC
7	CMOSTXD	Transmit CMOS
8	NC	NC
9	NC	NC

**NT3S-ST126B-E**

Com1 and Com2 Ports  
 Port Type: DB9 Female

Pin Number	Name	Description
1	NC	NC
2	232TXD	Transmit 232
3	RXD	Receive 232 / CMOS
4	NC	NC
5	GND	Circuit Ground
6	VCC	+5 VDC
7	CMOSTXD	Transmit CMOS
8	NC	NC
9	NC	NC

## Hardware

---

### NT2S-SF121B-EV2 / SF125B-E

Com1 Port (PLC Port)  
Port Type: DB9 Female

Pin Number	Name	Description
1	GND	Circuit Ground
2	232TXD	Transmit 232
3	RXD	Receive 232 / CMOS
4	GND	Circuit Ground
5	GND	Circuit Ground
6	VCC	+5 VDC
7	CMOSTXD	Transmit CMOS
8	DIR	Direction Control
9	PLC ATTACH	Attach PLC. Should be grounded inside the cable

### NT2S-SF122B-EV2 / SF126B-E

Com1 Port (PLC Port)  
Port Type: DB9 Male

Pin Number	Name	Description
1	NC	NC
2	DIR	Direction Control
3	232TXD	Transmit 232
4	VCC	+5 VDC
5	GND	Circuit Ground
6	CMOSTXD	Transmit CMOS
7	RXD	Receive 232 / CMOS
8	RXD	Receive 232 / CMOS
9	NC	NC



**NT2S-SF121B-EV2 / SF122B-EV2 / SF125B-E / SF126B-E**

Com2 Port (Serial Port)  
 Port Type: DB9 Female

Pin Number	Name	Description
1	NC	NC
2	TXD	Transmit RS232
3	RXD	Receive RS232
4	NC	NC
5	NC	NC
6	NC	NC
7	NC	NC
8	NC	NC
9	GND	Circuit Ground

**NT2S-SF123B-EV2 / SF127B-E**

Com1 Port (PLC Port)  
 Port Type: DB9 Male

Pin Number	Name	Description
1	NC	NC
2	NC	NC
3	NC	NC
4	VCC	+5 VDC
5	GND	Circuit Ground
6	CMOS TXD	Transmit CMOS
7	RXD	Receive CMOS
8	RXD	Receive CMOS
9	NC	NC

## Hardware

---

### NT2S-SF121B-EV2 / SF125B-E

Com1 Port (PLC Port)  
Port Type: DB9 Female

Pin Number	Name	Description
1	GND	Circuit Ground
2	232TXD	Transmit 232
3	RXD	Receive 232 / CMOS
4	GND	Circuit Ground
5	GND	Circuit Ground
6	VCC	+5 VDC
7	CMOSTXD	Transmit CMOS
8	DIR	Direction Control
9	PLC ATTACH	Attach PLC. Should be grounded inside the cable

### NT2S-SF122B-EV2 / SF126B-E

Com1 Port (PLC Port)  
Port Type: DB9 Male

Pin Number	Name	Description
1	NC	NC
2	DIR	Direction Control
3	232TXD	Transmit 232
4	VCC	+5 VDC
5	GND	Circuit Ground
6	CMOSTXD	Transmit CMOS
7	RXD	Receive 232 / CMOS
8	RXD	Receive 232 / CMOS
9	NC	NC

**NT2S-SF121B-EV2 / SF122B-EV2 / SF125B-E / SF126B-E**

Com2 Port (Serial Port)  
 Port Type: DB9 Female

Pin Number	Name	Description
1	NC	NC
2	TXD	Transmit RS232
3	RXD	Receive RS232
4	NC	NC
5	NC	NC
6	NC	NC
7	NC	NC
8	NC	NC
9	GND	Circuit Ground

**NT2S-SF123B-EV2 / SF127B-E**

Com1 Port (PLC Port)  
 Port Type: DB9 Male

Pin Number	Name	Description
1	NC	NC
2	NC	NC
3	NC	NC
4	VCC	+5 VDC
5	GND	Circuit Ground
6	CMOS TXD	Transmit CMOS
7	RXD	Receive CMOS
8	RXD	Receive CMOS
9	NC	NC

### **BEFORE YOU BEGIN**

In this chapter. . . .

- ◆ Connecting the HMI to a Computer
- ◆ Starting NTXS Software
- ◆ Setting Network Configuration

### 3.1 Connecting the HMI to your Computer

Before you start your first project, the HMI should be connected to the computer so that the project can be downloaded after creating it. You should also connect the PLC that you are using with the HMI so that you can test the operation of the HMI after you have finished creating the sample project.

- **To connect your HMI to the computer**

1. Connect a +24VDC power supply to the HMI.
2. Connect the programming cable to the computer and HMI.
  - Connect IBM cable to the communication port of NTXS.
  - Download Firmware i.e. driver for the PLC. The NTXS unit cannot communicate with PLC till the required driver is downloaded.
3. Apply power to the HMI.

- **To connect your PLC to HMI**

NTXS can communicate with any PLC without any change in the NTXS hardware. To communicate with a PLC, NTXS unit needs:

1. Proper Communication Driver for the PLC
2. NTXS - PLC communication cable

1. Communication Driver for the PLC:

Each PLC has a defined protocol for communicating with any device. Communication Driver is downloaded into NTXS unit along with the firmware. Communication driver varies from PLC to PLC. This driver enables unit to talk to a specific PLC, such as OMRON PLC.

2. NTXS:

PLC Communication Cable: Proper NTXS - PLC cable is required for error free communication with a PLC.

## Before you Begin

---

### 3.2 Starting NTXS Software

#### 3.2.1 Installing NTXS Software

System requirements for installing NTXS on your PC:

Windows Version	:	Microsoft Windows® 2000 or higher
Processor	:	266 MHz Pentium® II or higher
Pentium-compatible CPU	:	
Hard disk Space	:	150 MB free memory space
Serial Mouse device	:	Microsoft® mouse or compatible pointing device
RAM	:	At least 64 megabytes (MB) of RAM; more memory generally improves responsiveness
Display resolution	:	800x600 with 24 bit true color
Serial Port	:	One Serial Port for Downloading Required

To install NTXS Software:

1. Open Microsoft Windows.
2. Select Run and Pop up window appears. Type the path for installing the Setup. This will install NTXS Setup Software.
3. When you click on OK, Welcome window appears on the screen. Click on Next.

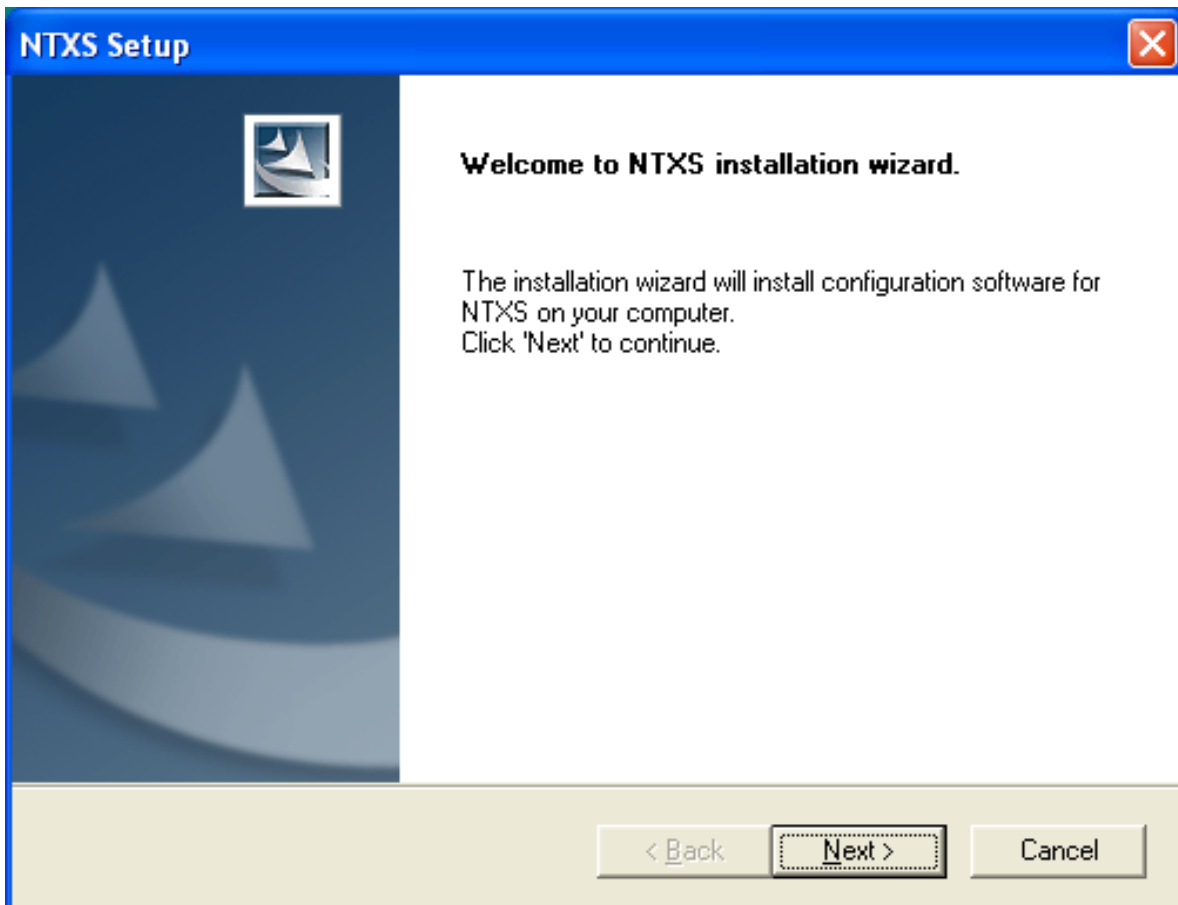

4. Enter User name and Company name.

The screenshot shows the 'NTXS Setup' window with the 'Customer Information' tab selected. The window title is 'NTXS Setup' and it has a close button in the top right corner. The main heading is 'Customer Information' with the instruction 'Please enter your information.' Below this, there is a sub-instruction: 'Please enter your name, the name of the company for which you work and the product serial number.' There are three text input fields: 'User Name:' containing 'Omron', 'Company Name:' containing 'Omron Europe B. V.', and 'Serial Number:' containing '0001'. At the bottom left, there is an 'InstallShield' logo. At the bottom right, there are three buttons: '< Back', 'Next >', and 'Cancel'.

5. Select the destination folder where Setup will install the files.

The screenshot shows the 'NTXS Setup' window with the 'Choose Destination Location' tab selected. The window title is 'NTXS Setup' and it has a close button in the top right corner. The main heading is 'Choose Destination Location' with the instruction 'Select folder where Setup will install files.' Below this, there is a sub-instruction: 'Setup will install NTXS in the following folder.' followed by 'To install to this folder, click Next. To install to a different folder, click Browse and select another folder.' There is a text input field labeled 'Destination Folder' containing the path 'C:\Program Files\Omron\NTXS V1.03'. To the right of this field is a 'Browse...' button. At the bottom left, there is an 'InstallShield' logo. At the bottom right, there are three buttons: '< Back', 'Next >', and 'Cancel'.

## Before you Begin

---

6. Select the Program folder.

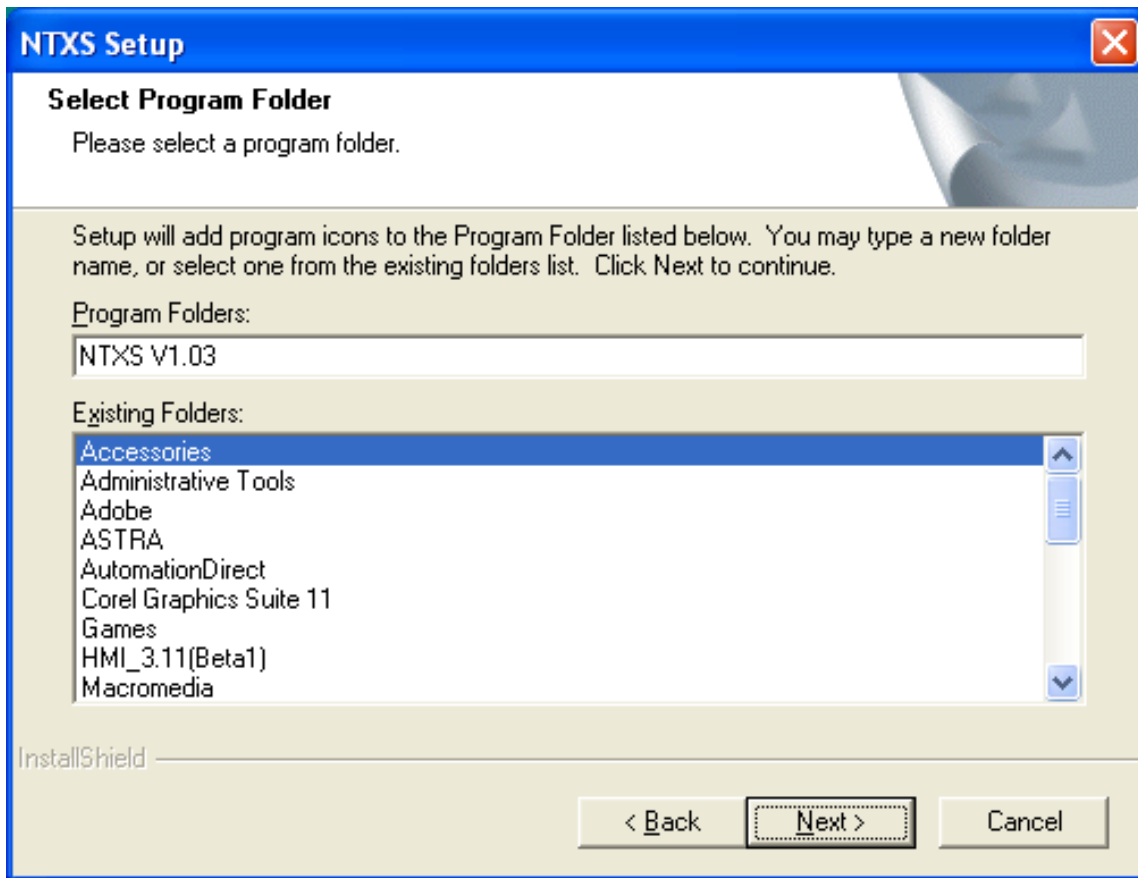

7. Installation starts. A dialog box indicating the status of progress of installation will display. A screen is displayed to inform you when installation is completed. This procedure installs NTXS Software in Start Menu (in selected folder).

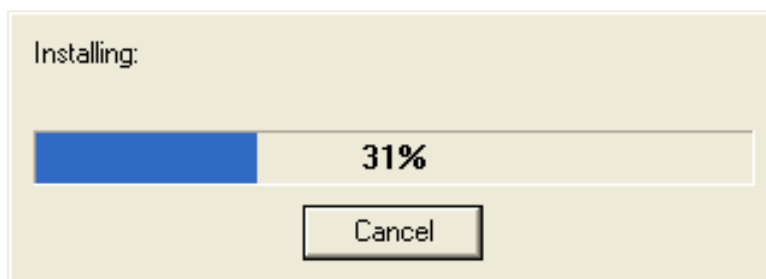

### 3.2.2 Steps for starting NTXS Software

1. In Windows click the Start button.
2. Select Programs.
3. Select NTXS V1.03.
4. Select NTXS V1.03.
5. Select New Application either from Tool station or from File Menu.
6. Select the model and product type that you would like to set by clicking on picture of the product in the list.
7. Define the Unit Settings and Network Configuration.
8. Next step is to define Tag Database and then define the screens according to your application.



### 3.2.3 Uninstalling NTXS Software

1. In Windows click the Start button.
2. Select Programs.
3. Select NTXS V1.03.
4. Select Uninstall NTXS V1.03.

Following screen will be displayed. The screen will ask you for the confirmation for uninstalling NTXS V1.03.

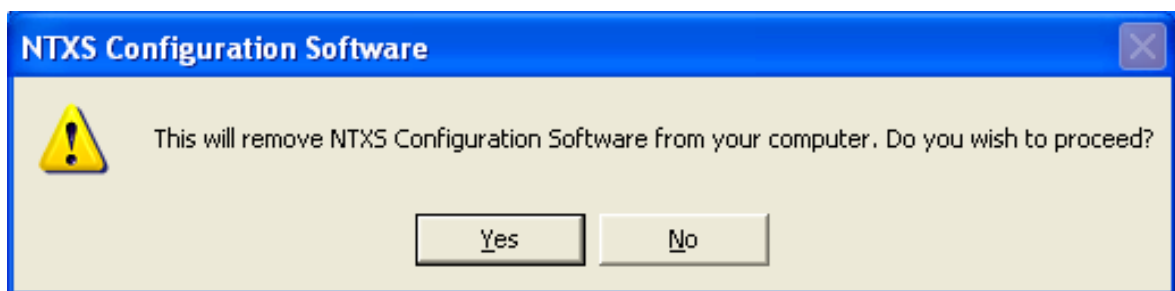

5. When you click on Yes, it will uninstall NTXS V1.03 from your computer.  
If you want to install NTXS V1.03, then you have to follow the steps as explained in section 3.2.1.

### 3.3 Setting Network Configuration

Unit can communicate with any PLC without any changes in the hardware. To communicate with PLC unit needs proper communication driver. Each PLC has a defined protocol for communicating with any device. PLC driver is downloaded into unit alongwith the firmware. This driver enables the unit to talk to a specific PLC.

Using this configuration screen you can set the node address and node name for each port. For NT2S units, node address can be set from 0 to 255 but for NT3S units, the highest node address is 32. You can change default values generated by editing these two fields. Protocol selection box displays list of all supported PLCs. By clicking this selection box you can see list of Model Numbers in PLC Model selection Box. Select PLC Name from PLC selection box and PLC Model name from PLC Model selection box.

PLC specific data button is activated only if selected PLC has Special PLC specific data to be set.

## Before you Begin

---

### 3.3.1 Setting Network Configuration For NT2S Series Products

Unit can be configured for PLC Communication.

Address	Name	NTXS / PLC	Blocks
000	Operator Panel	NT2S-SF121B-EV2	00000

Buttons: Add a node, Special PLC data, Delete the node

Node Address: [ ] [ 0 - 255 ]

Node Name: [ ] Max 15 characters

PLC: [ ]

PLC Model: [ ]

**Node Address:** User can assign unique node address starting from 0 to 255.

**Node Name:** User can specify node name, maximum upto 15 characters.

**PLC:** User can select desired PLC from the list of available PLCs.

**PLC Model:** User can select model for the desired PLC.

**Add a Node:** A new node is added in the network.

**Delete the Node:** The selected node can be deleted from the network.

### 3.3.2 Setting Network Configuration For NT3S Series Products

Unit can communicate with any PLC without any change in hardware. To communicate with PLC unit needs proper communication driver. Each PLC has a defined protocol for communicating with any device. PLC driver is downloaded in to unit along with the firmware. This driver enables the unit to talk to a specific PLC.

Unit can be configured in following ways:

1. For IBM Communication
2. For Serial Printing
3. For PLC Communication

Either of the ports can be configured for the ways mentioned above. Depending on the type of communication, user may require to define certain parameters.

The following table displays number of nodes connected on Com1 and Com2 with their Node address, node name, node type (unit / PLC), total number of blocks used in application.

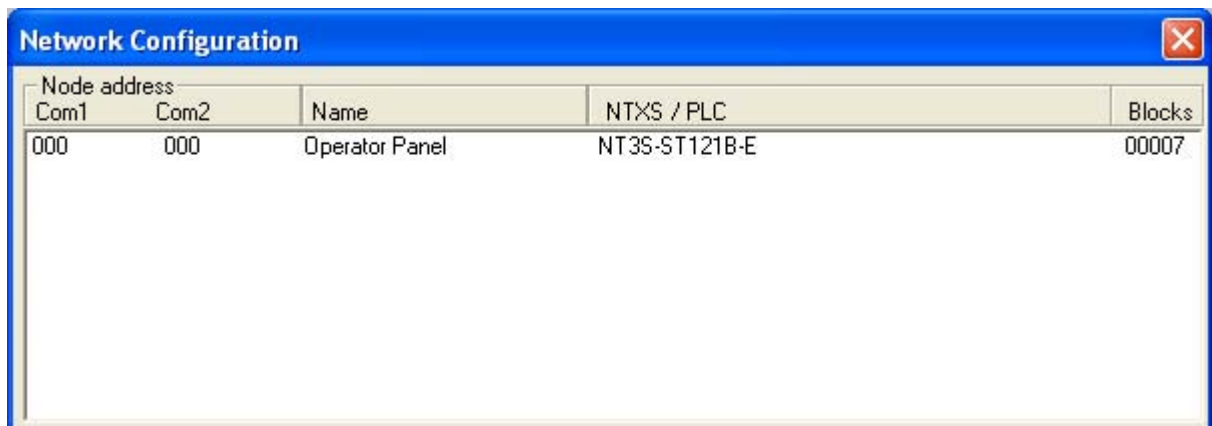

Node address		Name	NTXS / PLC	Blocks
Com1	Com2			
000	000	Operator Panel	NT3S-ST121B-E	00007

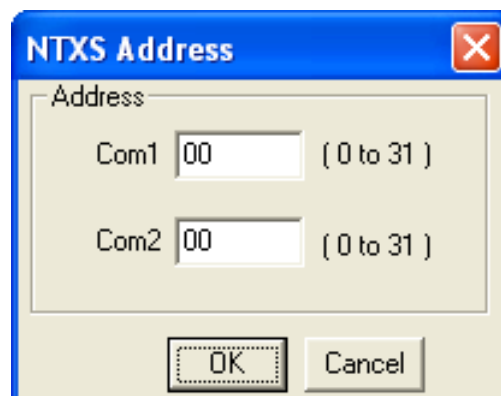

NTXS Address

Address

Com1  ( 0 to 31 )

Com2  ( 0 to 31 )

OK Cancel

Note: Default Node address for unit is 0 for COM1 and COM2. This address needs to be changed if settings for PLC address is same as unit address.

## Before you Begin

---

### 1. For IBM Communication

Node address		Name	NTXS / PLC	Blocks
Com1	Com2			
000	000	Operator Panel	NT3S-ST121B-E	00007

Port:

Protocol:

Model:

Node Address:  [ 0 - 32 ]

Node Name:  ( Max 15 characters )

This is default communication setting. If user wants IBM communication, no other setting is required. In this case both communication ports can be used for download / upload purpose.

2. For Serial Printing

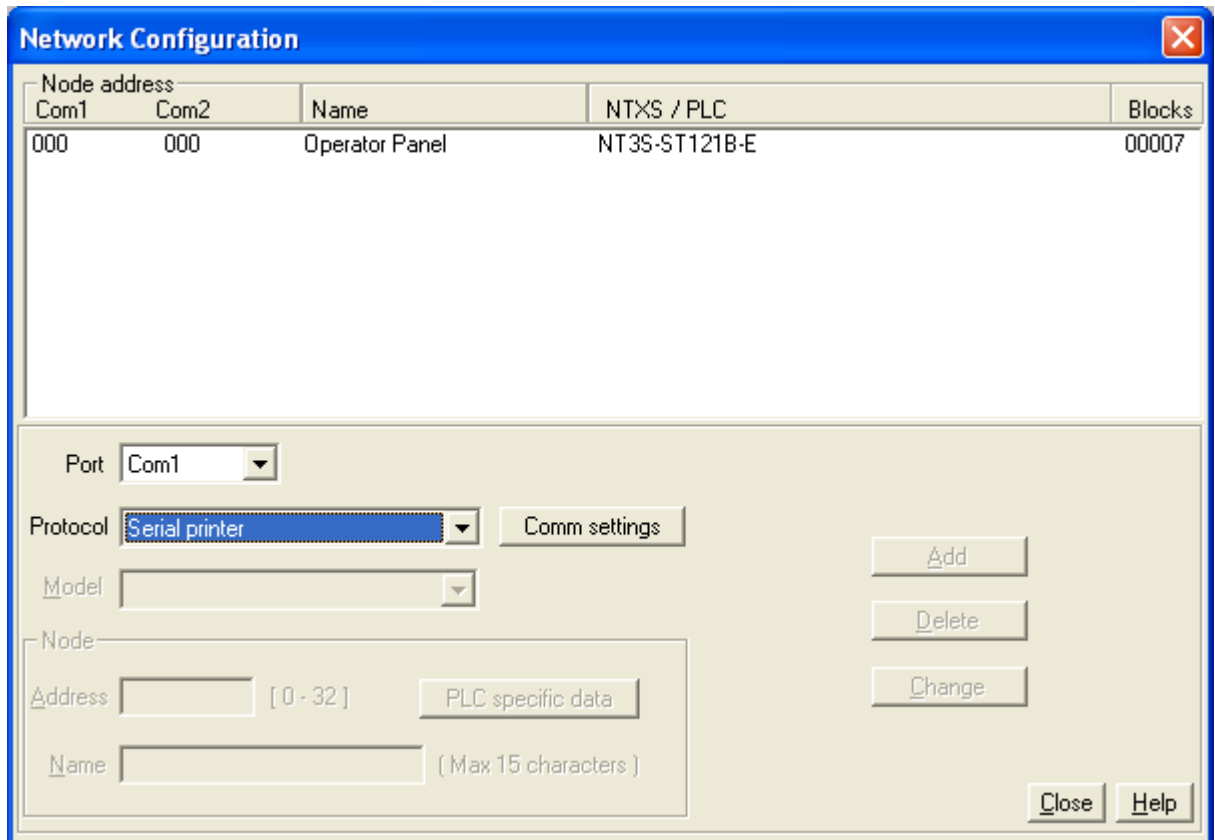

User can set either of the ports for serial printing. This is done by selecting Protocol as “Serial printer”. In the above example, user has configured Com1 for serial printing. However, when this port is not being used for printing, it will be used for IBM Communication.

User has to define parameters for serial printing, by using ‘Comm Settings’ option.

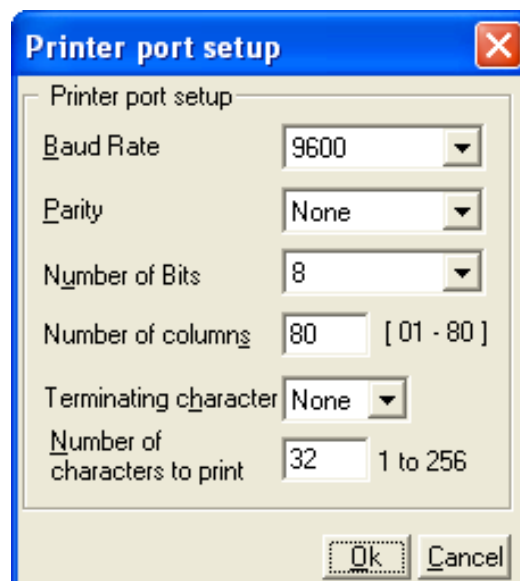

## Before you Begin

---

Following serial printing parameters can be set-

Baud Rate	- Supported Baud rates are 4800, 9600, 19.2K, 38.4K, 57.6K and 115.2K.
Parity	- Can be None, Even or Odd.
Number of Bits	- Can be 7 or 8.
Number of columns	- Can be from minimum 1 to maximum 80.
Terminating character	- Can be None, CR(Carriage Return), LF(Line Feed) or CR+LF.
Number of characters to print	- Can be from minimum 1 to maximum 256.

Click 'Ok' to set printer setting.

### 3. For PLC Communication

**Network Configuration**

Node address		Name	NTXS / PLC	Blocks
Com1	Com2	Operator Panel	NT3S-ST121B-E	00007

Port:

Protocol:

Model:

Node

Address:  [ 0 - 32 ]

Name:  ( Max 15 characters )

**Protocol** - User can select desired PLC from the list of available drivers. In the example shown above, user has selected Omron Host Link at Com1.

Port Settings -

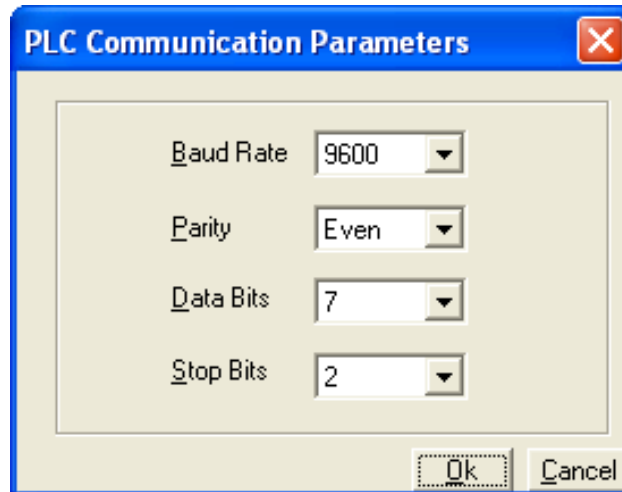

User can set PLC communication parameters like Baud Rate, Parity, Data Bits and Stop Bits. Click 'Ok' to set parameters.

**Model -** User can select desired PLC model from the list available. In the example shown above, user has selected 'CJ1' model.

**Address -** Unique PLC node address ( 0 to 32 ).

**Name -** User can specify node name, which can be maximum up to 15 characters.

**Add a Node -** User can add a node in the network.

**Change a Node -**

User can change PLC or PLC related information. First of all user has to select the node. Then change the information and finally click the button 'Change a Node'.

**PLC specific data -**

If additional information is required for PLC, user can select the node. Then this button is activated. Now by clicking on this button user can provide the desired information.

**Delete node -** To delete a node, first of all user has to delete all the tags defined for the node. Then user has to select the node and click the Delete button.

Omron Frame delay can be set using the screen shown below:

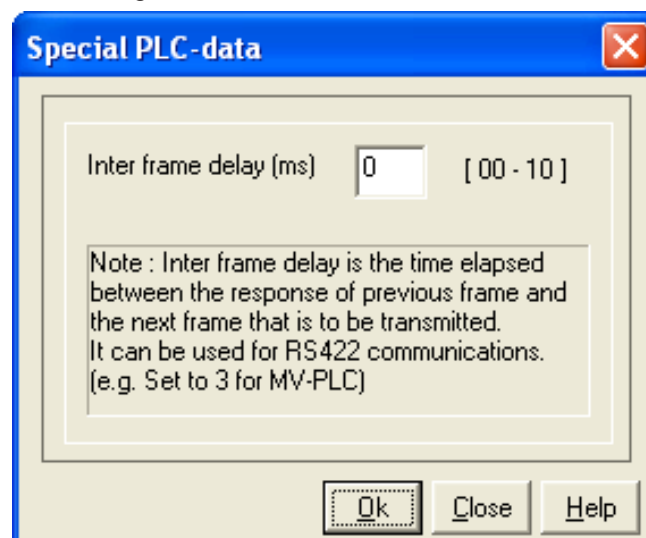

### USING NTXS SOFTWARE

In this chapter. . . .

- ◆ NTXS Menu Structure
- ◆ Creating New Application
- ◆ Creating Screens
- ◆ Data Entry Object
- ◆ Display Data Object
- ◆ Global And Power On Tasks
- ◆ Global Keys
- ◆ Screen Keys



#### 4.1 NTXS Menu Structure

From Windows Task Bar, click the **Start** button and select the NTXS V1.03.  
The following Window will appear.

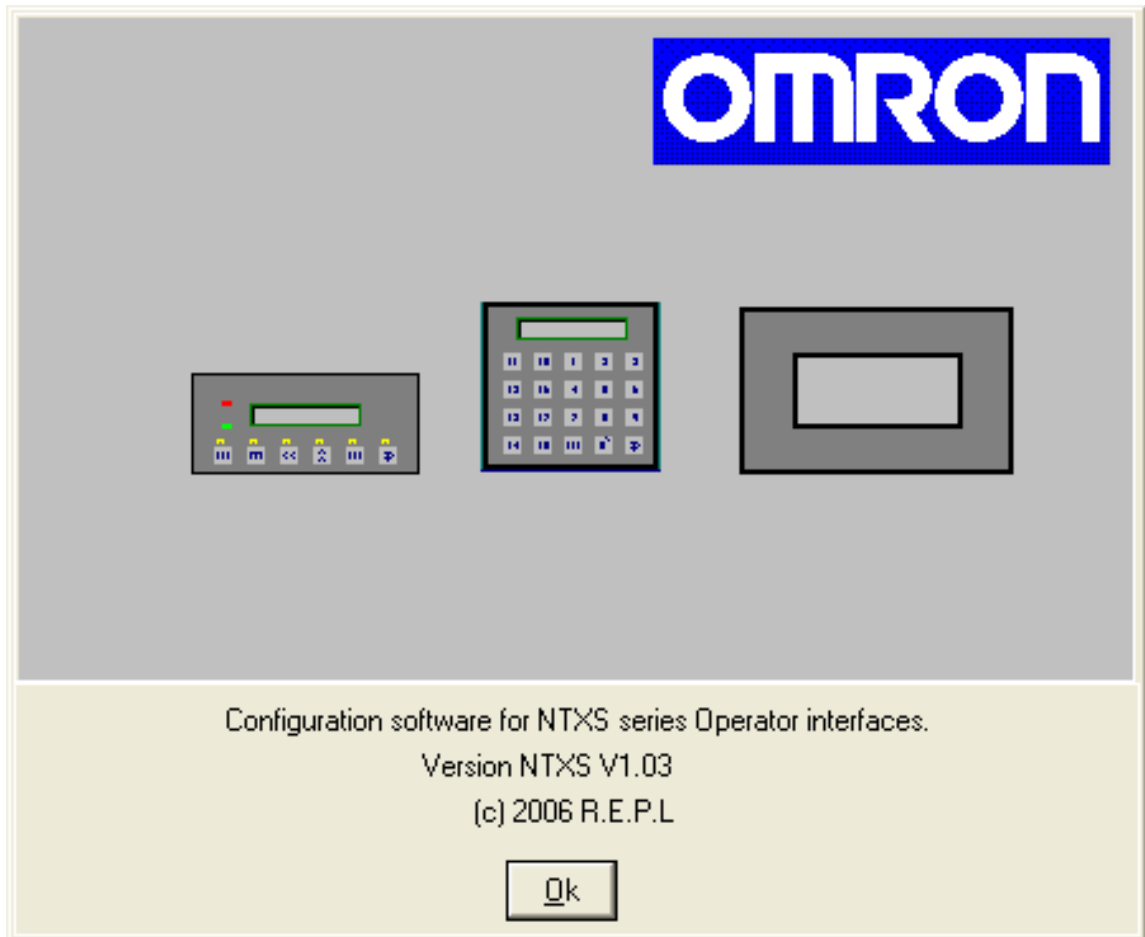

The Program displays a Splash screen on Start-up. This dialog can be closed by pressing any key or just by clicking mouse or waiting 10 seconds for it to automatically go to the next screen (i.e. Toolstation).

## Using NTXS Software

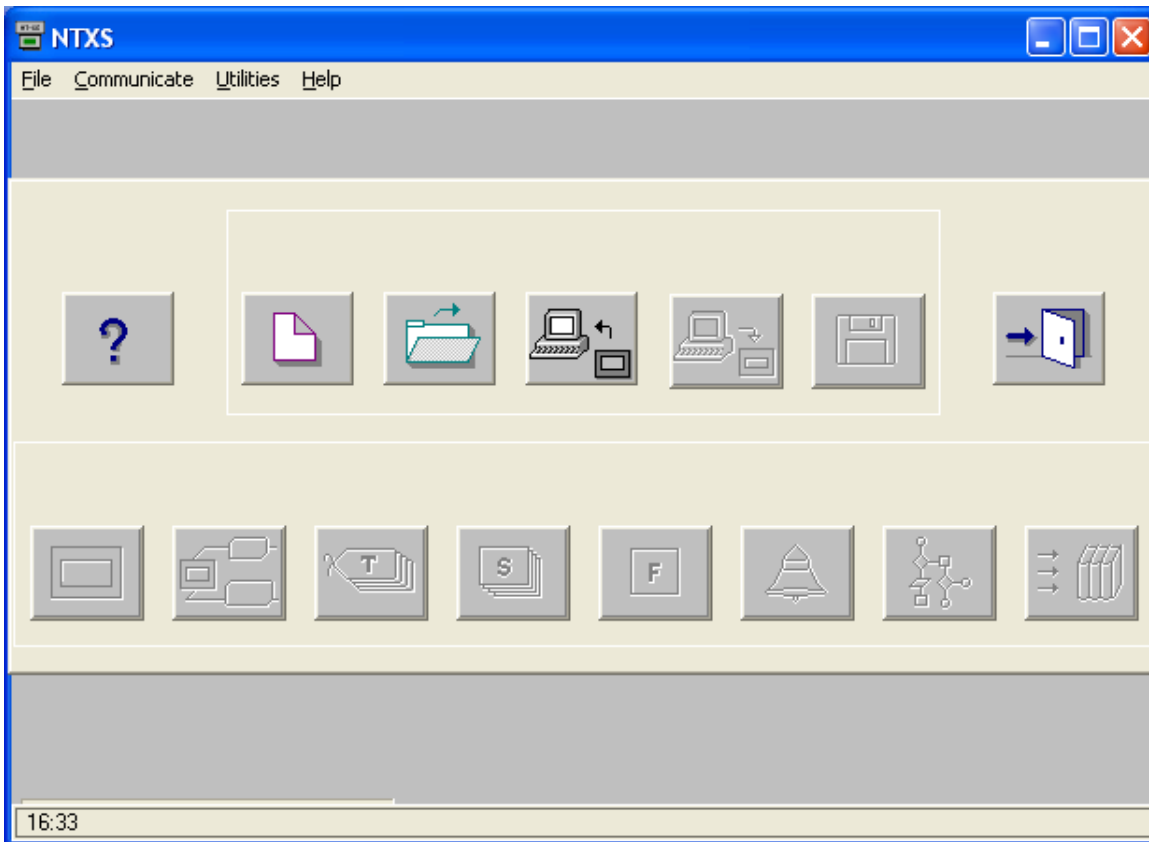

Menu bar operates like any standard Windows Menu bar. To open a particular Menu click it with the help of Mouse or use key alongwith **ALT** key just like any other standard Windows based software. When no application is opened above Menu bar will be displayed.

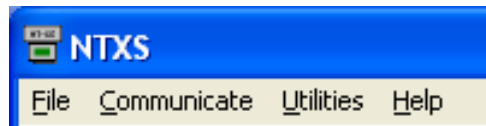

The Tool-Station consists of icons. When the mouse points to any icon, a tool-tip is displayed. Click on the icon to select the particular menu.

Now we will study the different Menus in the Menu Bar.

### 4.1.1 File Menu

File Menu handles the File related functions. File Menu consists the functions like New Application, Close Application, Save Application, Print and Exit NTXS. Using Information option user can set or change NTXS application information such as application title, user name etc.

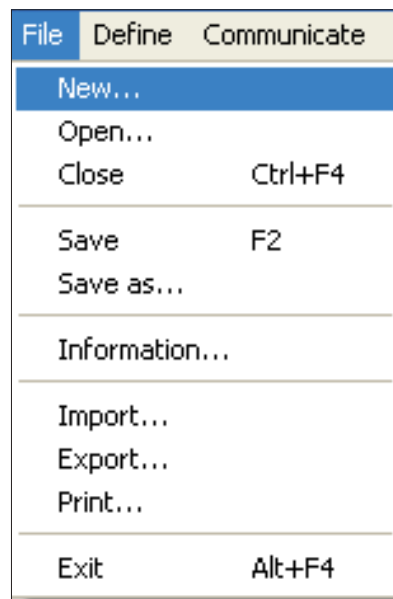

- |                         |   |  |
|-------------------------|---|--|
| <b>N</b> ew             | - | Creates a new application.   |
| <b>O</b> pen            | - | Opens a saved application.   |
| <b>C</b> lose           | - | Closes currently opened application.   |
| <b>S</b> ave            | - | Saves currently opened application.  |
| <b>S</b> ave <b>a</b> s | - | Saves the current application with a different name.   |
| <b>I</b> nformation     | - | Configure application specific information such as application title, author, password etc.  |
| <b>I</b> mport          | - | All the text data associated with wizards (On / Off text, labels etc.) can be imported. (Refer to USING LANGUAGES Chapter for more information)  |
| <b>E</b> xport          | - | Exports data from NTXS projects and put it into a user specified file. (Refer to USING LANGUAGES Chapter for more information)   |
| <b>P</b> rint           | - | Either prints all the current application information such as Project information, Unit settings, NTXS nodes, tags, screens, application tasklist, screen tasklist, alarms or the selected attributes. |
| <b>E</b> xit            | - | Exits NTXS Software.   |

## Using NTXS Software

---

### 4.1.2 Define Menu

This menu defines the application. In the main window of NTXS Software, bottom line of the icons is dedicated for this menu.

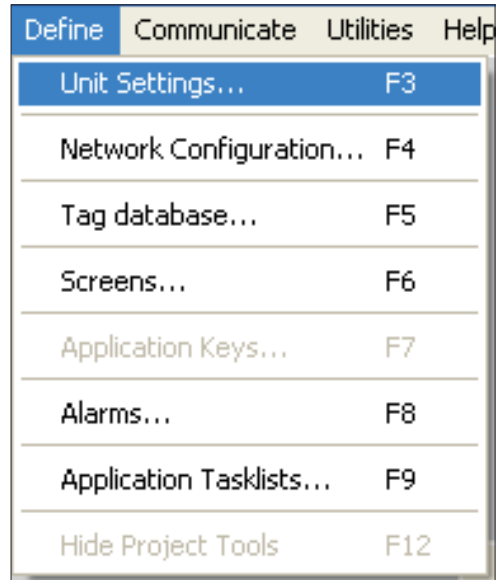

- Unit Settings - Defines Unit settings. Normally there is no need to change these settings.
- N**etwork Configuration - Defines PLC node, node ID etc.
- T**ag DataBase - Defines tags to be used in the application.
- S**creens - Defines screens.
- Application **K**eys - Defines application keys.
- A**larms - Defines alarms in the application.
- Application Task-List - Defines Power-on and Global Tasklist.
- Hide Project Tools - When checked, hides the project toolbox.

### 4.1.3 Communicate Menu

Communicate Menu has options like selecting COM port, downloading or uploading NTXS application etc.

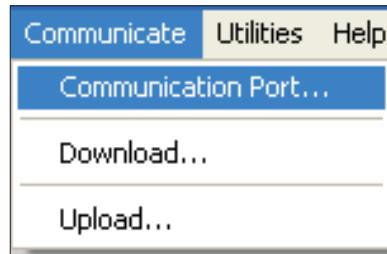

- Communication Port - Sets COM port for communicating with NTXS.
- Download - Downloads Application to NTXS Unit.
- Upload - Uploads Application from NTXS Unit.

### 4.1.4 Utilities Menu

Utilities Menu informs the user about the memory used for the application. This menu has other options like Font Editor, image conversion and Convert application.

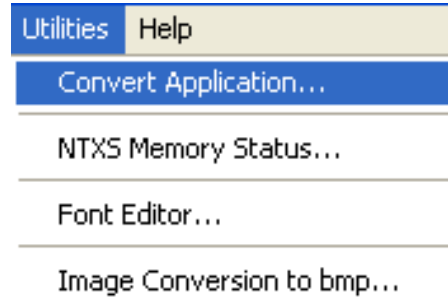

- Convert Application - Converts opened application.
- NTXS Memory status - Displays statistics of the memory used by the current application.
- Font Editor - User can edit the fonts by using the Font Editor utility.
- Image Conversion to bitmap - Converts images from any type of picture format to bitmaps.

## Using NTXS Software

---

### 4.1.5 Help Menu

Help menu offers help for the user application and information about the NTXS version.

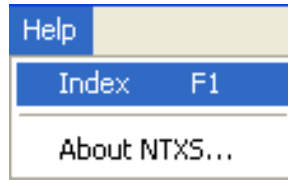

- I**ndex - Lists all the Help topics
- A**bout NTXS Software - Displays the software version number.

### 4.2 Creating New Application

A User can create a new application either from Menu Bar or from Tool Bar.

- ◆ Creating a New Application from Menu Bar:  
Click on New From File Menu or New Application icon from Toolbar. It will create new application.

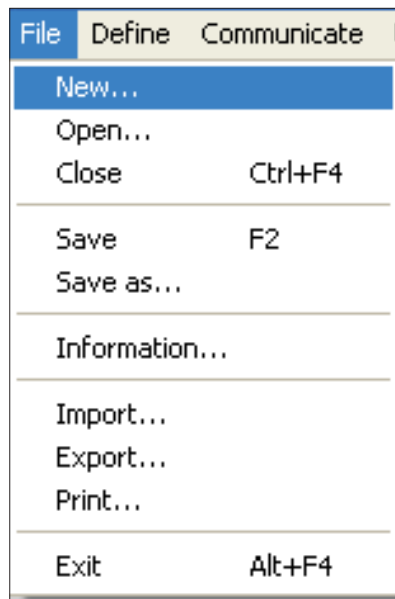

OR



Click on the New Application icon either from File Menu Bar or Tool Bar. Following screen will be appeared.

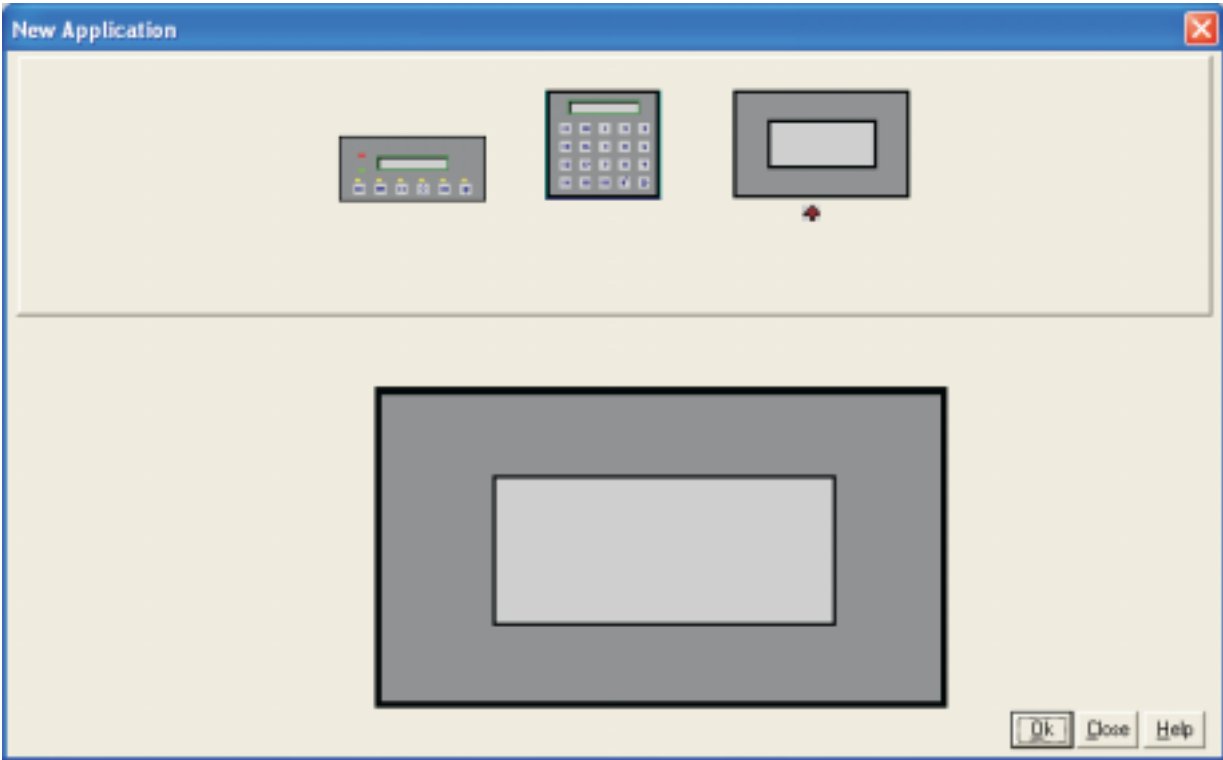

This screen shows list of all NTXS units. Select the required product from the list of products that you would like to set by clicking on the picture of the product in the list. An enlarged picture of the product is also shown below the list.

On clicking Ok product type selection screen will display -

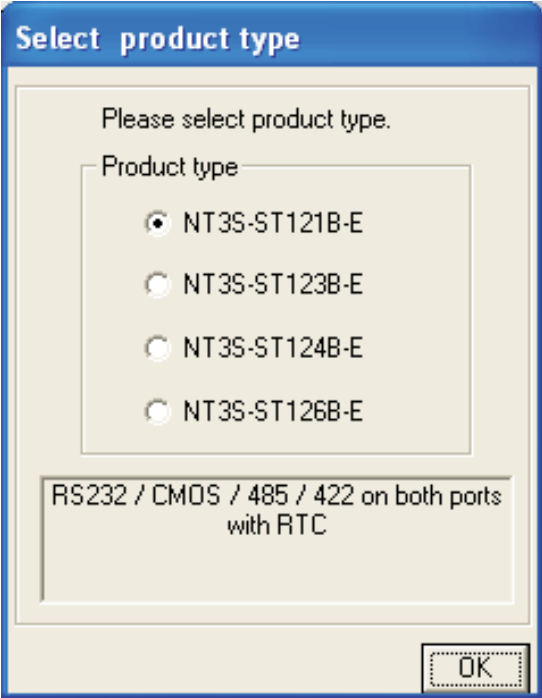

## Using NTXS Software

---

Select the type of Product and then click OK to start the Application.

### Steps for creating a new application are as follows:

- 1) Start a new project using either File Menu or Tool section New command.
- 2) Define Unit Settings.
- 3) Define Network Configuration for selected unit and PLCs.
- 4) Define the tags in the Tag database required for the project / application.
- 4) Define the screens.
- 5) Define Power-on, Global and Screen tasks.
- 6) Save your application.
- 7) Download firmware to the unit.
- 8) Download your application to the unit.

### Tag Database

This is the central database for the tags which need to be used in the application. Once the tags are defined (as register or coils) and their attributes selected, the tags can be used in the application on screens, tasks, alarms etc. This screen helps you to define Tags associated with defined Nodes. Tag is nothing but a Register or Coil or Individual bit of any register. Select type of the tag from Tag Type field which is either Register or Coil Type.

If type of tag selected is register then number of bytes to be fetched varies from 1, 2, 4, etc. For displaying or editing float data number of bytes of tag must be 4. Tag Name field is user definable. Tag is not added in Tag list unless you define Tag name. Once you define all these fields click on **Add** button for adding Tag in Tags List Box. Block field of this tag database defines Block starting address followed by Block size.

For example : Tag M0214 is within a block ( M0214 : 1 ) whose starting address is M0214 and block size is 1. This block size is optimized automatically depending on address of PLC Tag.

Default block size is either 1 or 16. This setting varies from PLC to PLC.

Attributes of existing Tag can be changed by clicking on **Change** button. Note that Change button is activated only if tag in the tag list is selected. Existing Tag can be removed from Tag list by clicking on **Delete** button. However, user can delete the tags only if they are not used in any screen.



## Tag Database for NT2S Series:

The screenshot shows the 'Tags' dialog box with the following fields and controls:

- Table:** Columns: No, Port, Node, Block, Tag, Byte(s), Tag-Name.
- Node:** Dropdown menu showing '[ 000 : Operator Panel ] NTXS-unit'.
- Tag-Type:** Radio buttons for 'Register' (selected) and 'Coil or Bit-addressed Register'.
- Register:** Text boxes for 'Size : 2 bytes' (with '[0000 - 0999]' range), 'D0000', and '0000' with up/down arrows.
- Tag-Name:** Text box with 'Max 40 chars' label.
- Byte(s):** Dropdown menu showing '2-Bytes (1-Word)'.
- Buttons:** Close, Help, Delete, Add, Change, Cancel.

**Add** - User can add tag with this button. Before clicking this button user has to select

1. Node : For which tag is going to be defined.
2. Read : Write Register or coil - User can select Read only or Read-Write type tag.
3. Tag Type : Register / Coil or Bit addressed Register. User has to choose the register number or coil number within the limit shown.
4. Tag name : Each register / coil in the unit /PLC memory has a unique and specific name to identify it. User can define name up to 40 characters.
5. Byte(s) : If selected tag is of register type then user can define it as a 1- byte ( Low-byte / High-byte), 2-byte, 4-byte.

**Change** – User can change tag information (like register/coil number, tag name, Byte(s)) by selecting tag. Change the information and then click on Change button.

**Delete** - Select the tag and click on Delete button to delete the tag. Before deleting any tag, the user must delete any references to the tag in screens and tasks. Otherwise it can not be deleted.

## Using NTXS Software

### Tag Database for NT3S Series

No	Port	Node	Block	Tag	Byte(s)	Tag-Name
00001	00	000	S0001 : 001	S0001	2	Language
00002	00	000	S0003 : 001	S0003_14	-	Comm1 status
00003	00	000	S0003 : 001	S0003_15	-	Comm2 status
00004	00	000	S0004 : 001	S0004	2	Number of Historical alarms
00005	00	000	S0005 : 001	S0005	2	Screen trigger register
00006	00	000	S0007 : 001	S0007	2	Battery voltage
00007	00	000	s0009 : 001	s0009	-	Beeper On/Off
00008	00	000	s0010 : 001	s0010	-	Battery status

**Node:** [ 000 : Operator Panel ] NTXS-unit  
**Tag-Type:**  Register  Coil or Bit-addressed Register  
**Register:** Size: 2 bytes [0000 - 0063], Register: S0000, Address: 0000  
**Tag-Name:** [ ] Max 40 chars  
**Byte(s):** 2-Bytes (1-Word)

**Add** - User can add tag with this button . Before clicking this button user has to select

1. Node : For which tag is going to be defined.
2. Read : Write Register or coil - User can select Read only or Read-Write type tag.
3. Tag Type : Register / Coil or Bit addressed Register. User has to choose the register number or coil number within the limit shown.
4. Tag name : Each register / coil in the unit /PLC memory has a unique and specific name to identify it. User can define name up to 40 characters.
5. Byte(s) : If selected tag is of register type then user can define it as a 1- byte ( Low-byte / High-byte), 2-byte, 4-byte.

**Change** – User can change tag information (like register/coil number, tag name, Byte(s)) by selecting tag. Change the information and then click on Change button.

**Delete** - Select the tag and click on Delete button to delete the tag. Before deleting any tag, the user must delete any references to the tag in screens and tasks. Otherwise it can not be deleted.

**Default System Tags**

**1. System Registers**

Tags	Tag Name	Read / Write	Description
S0001	Language	Read / Write	Writing the value will change languages used in any wizard
S0003_14	Comm1 status	Read Only	0 = Communication Error 1 = Communicating with PLC
S0003_15	Comm2 status	Read Only	0 = Communication Error 1 = Communicating with PLC full status
S0004	Number of Historical	Read Only	Shows number of alarms stored in memory Alarms
S0005	Screen Trigger	Read / Write	Shows active screen no. User can change Register screen by writing any valid screen no in this register
S0007	Battery Voltage	Read Only	Indicates battery voltage in ## format
S0008	Error code for Xtradrive Com1	Read only	Error code byte for Xtradrive for Com1
S0009	Error code for Xtradrive Com2	Read only	Error code byte for Xtradrive for Com2

**2. System Bits**

Tags	Tag Name	Read / Write	Description
s0009	Beeper On /Off	Read / Write	0: Enable Beeper 1: Disable Beeper User can change this bit at Run time.
s0010	Battery Status	Read only	0: Battery voltage is OK (i.e.above 2.2 V) 1: Low Battery (i.e. below 2.2V)
s0011	Start / Stop jog	Read / Write	Used in jog operation of Xtradrive for port1 for Xtradrive Com1 1: Continuous jog operation on port1 0: Stop jog operation on port1
s0013	Start / Stop jog	Read / Write	Used in jog operation of Xtradrive for port2 for Xtradrive Com2 1: Continuous jog operation on port2 0: Stop jog operation on port2

## Using NTXS Software

### 4.3 Creating Screens

Screens are the most important part of any application as they display the information required by the operator. NTXS has various objects to make a screen operator-friendly. Click on Screens icon to define screens.



In the Screens dialog box, enter the screen number, name and password. Select screen properties and screen type.

- Screen Number** : Screen number can be from 1 to 65534 for NT2S models. For NT3S models screen number can be from 1 to 65000 as shown in the following screen. The screen number is unique.
- Screen Name** : Screen name can be upto 20 characters. It is displayed only in software configuration.
- Password** : User can protect screen information by giving password to the screen. User can assign any number from 1 to 9999 as screen password.

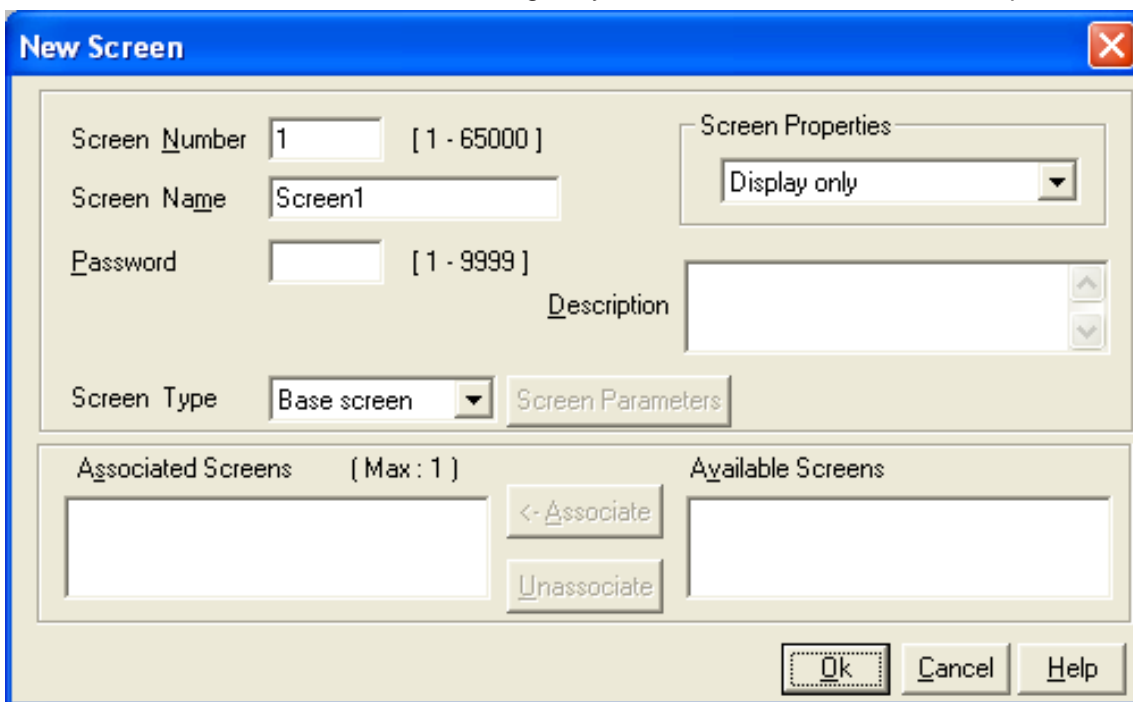

#### Screen Properties -

1. Display only : If the screen property is 'Display only' then the screen information is displayed on LCD.
2. Print Only : Screen, having this property, will not be displayed. Alphanumeric data on the screen goes to serial printer only once and control jumps back to last displayed screen. User has to define the port as 'Serial Printer' port if he wants to assign this property to screen. Either of the ports can be configured for printing. When the print screen is activated, the print data will be sent from the printer port.
3. Print Once / display : If screen has this property, first of all Alphanumeric data on the screen goes to serial printer and then the screen is displayed on LCD. User has to define the port as 'Serial Printer' port for assigning this property to the screen. Either of the ports can be configured for printing. When the print screen is activated, the print data will be sent from the printer port.

**Description :** User can write the information about the screen for the reference. This description is only for software configuration. It is not displayed on the unit.

**Associated Screens :** Associated screen is useful in the case where one or more objects are common between different screens. The common data from all the screens is placed in a screen and this screen is associated with the other screens.

Advantage of associated screen -

1. It saves application memory.
2. It saves time of the application programmer.

**Note :** Only one screen can be associated to any screen.

No data entry objects can be placed in the screen to be associated.

Embedding any PLC information is not supported in associated screen.

User can 'unassociate' a screen.

**Available Screens** - List of available screens is displayed.

Click 'Ok' to edit the screen.

### 4.3.1 Protecting Application Using Password

NTXS application can be password protected. This protection is applicable for both during uploading an application and during opening NTXS application. To make application password protected define password in application information screen. Define password for application and download or save the application. Following screen will appear during application uploading or during opening an application.

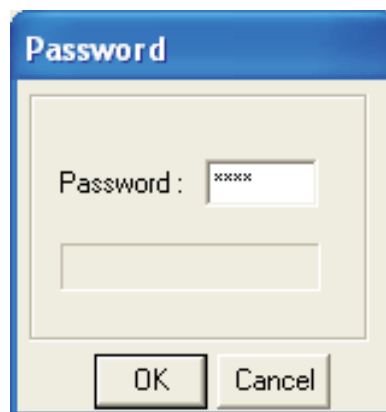

### 4.4 Data Entry Object

Any register or coil from the unit or PLC memory, except Read-only registers and coils, can be edited using the numeric keypad.

Procedure -

1. Click on the Data Entry button from objects toolbar.
2. The mouse pointer will change to the tool shape. Now place the mouse pointer at desired location and click the left mouse button. The data entry dialog box will appear.

Data Entry objects are explained in detail in chapter 5.

## Using NTXS Software

---

### 4.5 Display Data Object

This object is used to display the contents of the register or coil.

Procedure-

1. Click on 'Display Data' from objects toolbar. The mouse pointer will change to the tool shape.
2. Now place the mouse pointer at desired location and click the left mouse button. The data entry dialog box will appear.

Display data object is explained in detail in chapter 5.

### 4.6 Global And Power On Task

1. **Power-on Tasks** - Tasks specified under this option execute only once when unit is powered on.
2. **Global Tasks** - Tasks specified under this option execute continuously as long as unit is powered.

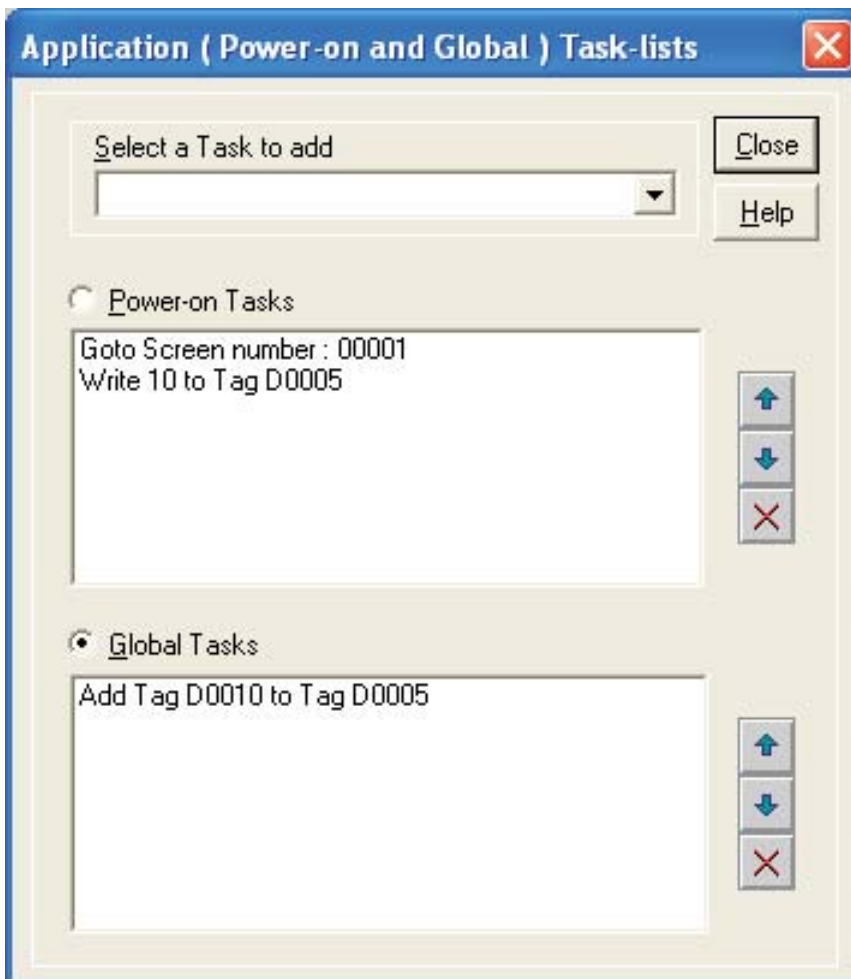

Select a Task to add

This drop down list allows the user to select a task to be executed. A task list contains multiple tasks.

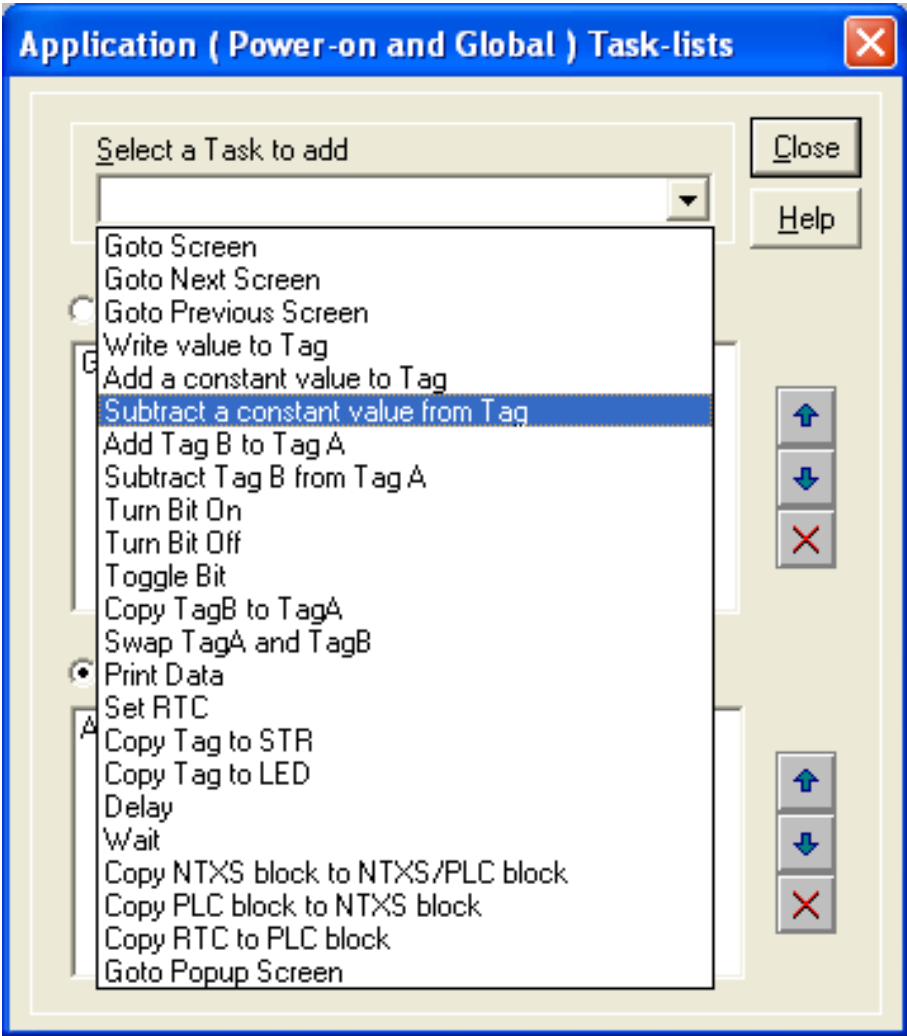

**Close**  - Accepts the selected task.

**Up arrow**  - Shifts the selected task upwards.

**Down arrow**  - Shifts the selected task downwards.

**Delete**  - Deletes the selected task.

## Using NTXS Software





### 4.7 Global Keys

Define tasks for these key events -

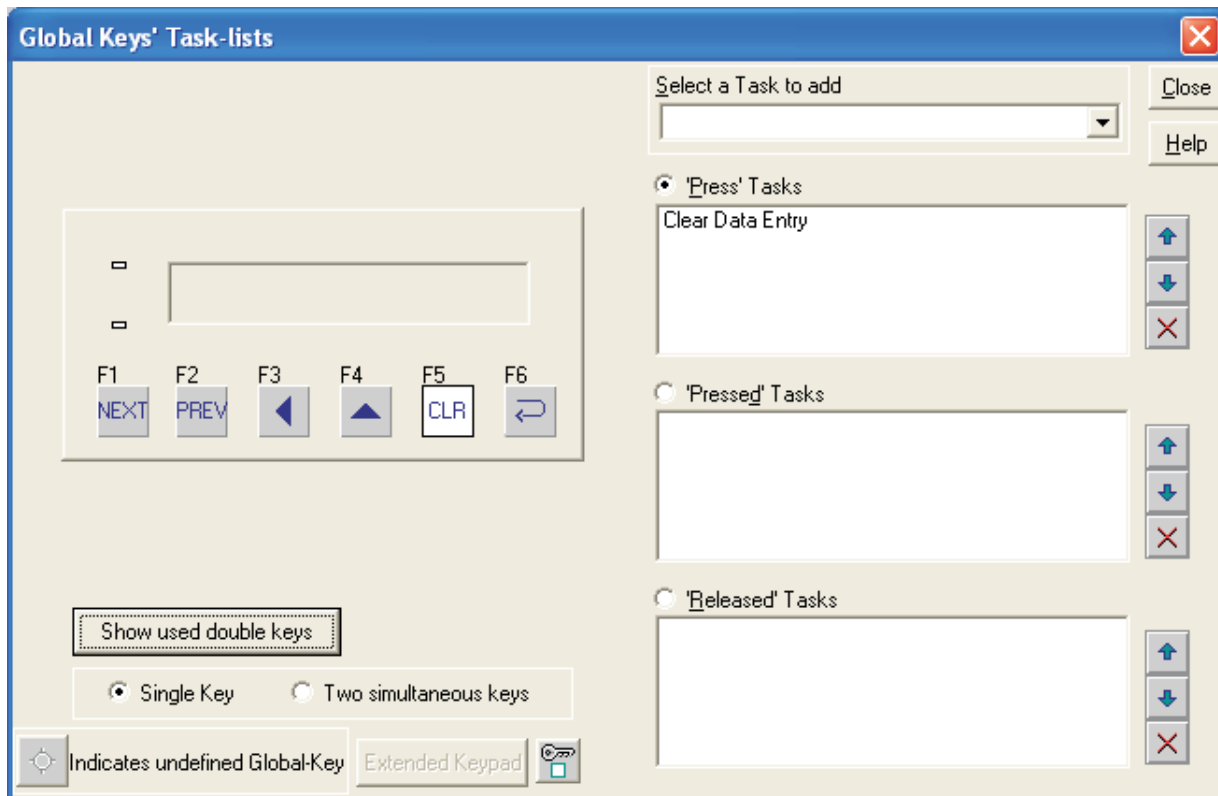
- Press Tasks** – These tasks are performed only once when the key is pressed.
- Pressed Tasks** – These tasks are performed as long as the key is pressed.
- Released Tasks** – These tasks are performed when the key is released.

Tasks defined for Global Keys are executed for whole application, independent of which screen is being displayed.



- Close**  - Accepts the selected task.
- Up arrow**  -Shifts the selected task upwards.
- Down arrow**  -Shifts the selected task downwards.
- Delete**  -Deletes the selected task.
- Show used double keys** -Shows the list of combination keys used to define the tasks.
- Single Key** -If this option is selected, a task is defined on a single key.
- Two simultaneous keys** -If this option is selected, a task is defined on a combination of two keys.

**Note:** Global keys Task list is applicable for only NT2S Products.







## 4.8 Screen Keys

Define tasks for key events for a specific screen -

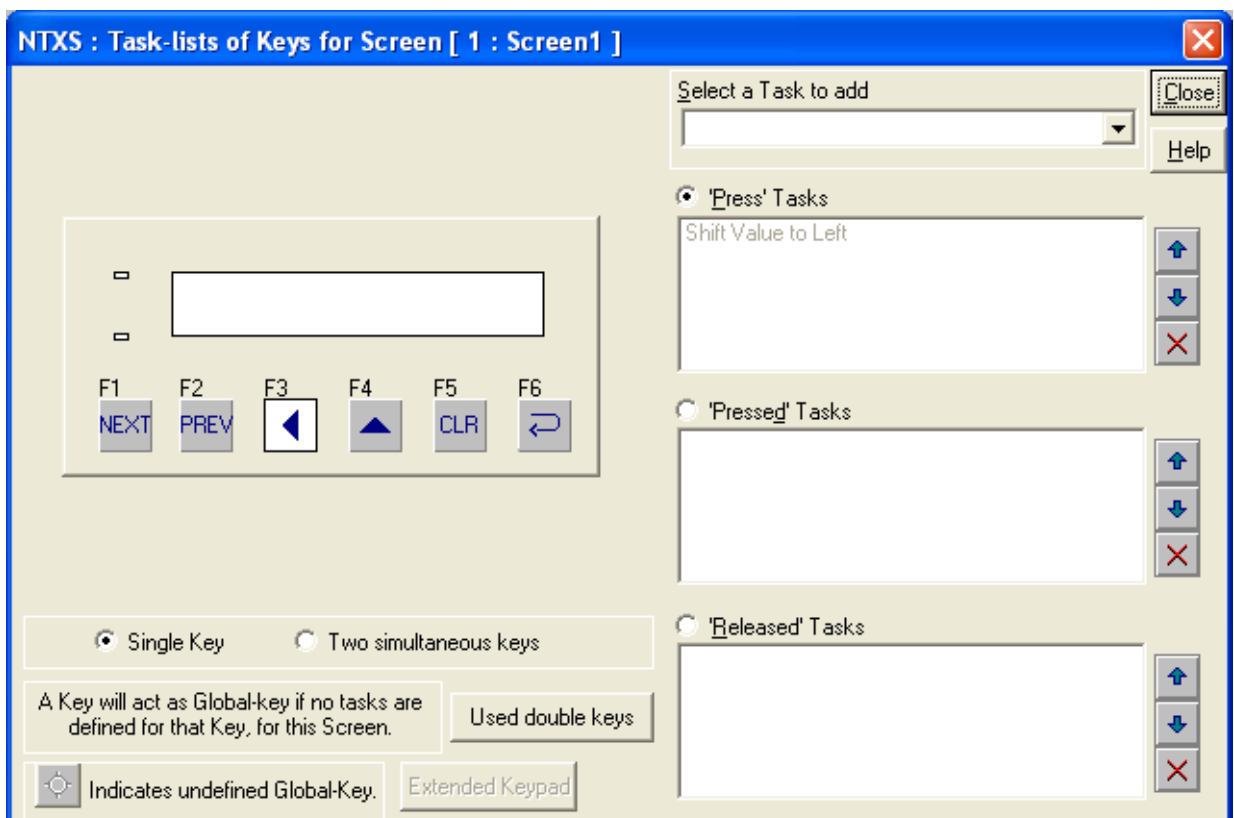
- Press Tasks** – These tasks are performed only once when the key is pressed.
- Pressed Tasks** – These tasks are performed as long as the key is pressed.
- Released Tasks** – These tasks are performed when the key is released.

Task defined under this option are executed only for the currently displayed screen . These are screen dependent tasks.



- Close**  -Accepts the selected task.
- Up arrow**  -Shifts the selected task upwards.
- Down arrow**  -Shifts the selected task downwards.
- Delete**  -Deletes the selected task.
- Used double keys** -Shows list of combination keys used to define the task..
- Single Key** -If this option is selected, a task is defined to one key.
- Two simultaneous keys**-If this option is selected, a task is defined to a combination of two Keys.

**Note:** Screen Keys' Tasklist has higher priority over Global Keys' Tasklist when the screen is displayed.

### REPRESENTING DATA BY OBJECTS AND WIZARDS

In this chapter. . . .

- ◆ Alphanumeric Objects
- ◆ Graphics Objects
- ◆ Wizards

## 5.1 Alphanumeric Objects

Alphanumeric objects are text objects with certain properties or attributes. By using various attributes, the designer can emphasize the importance of a particular text object. The alphanumeric objects in models with a graphics display have some additional attributes.

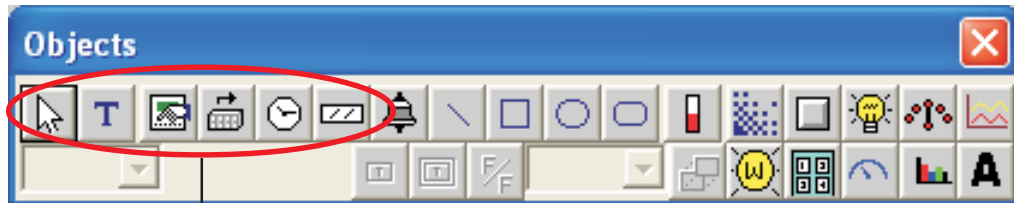

Alphanumeric Object

Alphanumeric Objects Types:

1. Text Object
2. Data Entry
3. Display Data
4. Time
5. Date

### 5.1.1 Text Objects

Text object is useful for displaying any message for the operator. Plain text objects do not depend on the PLC.

#### Procedure

1. Click on the Text button in screen Objects Toolbar or Menu option. The shape of the mouse pointer will change.
2. Now place the mouse pointer at desired location and mark the area of text object while holding the left mouse button.
3. A block cursor will blink at the location inside the text outline. Now enter the text. Last character will be overwritten If insert mode (Computer Keyboard) is disabled, else new character will not be accepted.

### 5.1.2 Data Entry Objects

Any read/write register or coil from the unit or PLC memory can be edited using the numeric keypad.

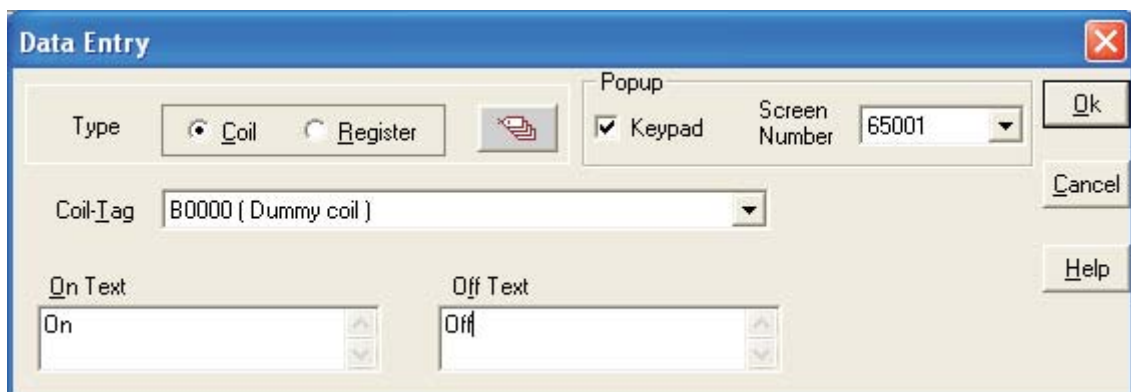

## Representing Data

---

This box will allow user to select either Coil Data Entry or Register Data entry. By default Coil data entry is selected

1. **Coil-Tag** : Select Coil tag from the list.
  2. **On Text** : Enter On text maximum up to 40 characters.
  3. **Off Text** : Enter Off text maximum up to 40 characters.
  4. **Popup** : If user wants data entry with popup keypad then user has to check **Keypad** option and also select popup screen number from the list. If user don't want popup data entry then he has to add static numeric keypad object on screen.
- To edit a register, select **Register Data Entry** .

The screenshot shows the 'Data Entry' dialog box. At the top, there are two radio buttons for 'Type': 'Coil' and 'Register'. The 'Register' option is selected. To the right, there is a 'Popup' section with a checked 'Keypad' checkbox and a 'Screen Number' dropdown menu showing '65001'. Below this is a 'Register-Tag' dropdown menu showing 'D0005 ( D5 )'. Further down, there are two dropdown menus: 'Data Type' set to 'Unsigned integer' and 'Format' set to '#####'. Below these are two rows for limits: 'Low-limit' with a text box containing '0' and 'High-limit' with a text box containing '65535'. At the bottom, there are two rows for operations: '1st-operation' and '2nd-operation', each with a set of buttons (NOP, +, -, \*, /) and a text box containing '[ 0 to 65535 ]'. On the right side of the dialog, there are three buttons: 'Ok', 'Cancel', and 'Help'.

Register Data Entry dialog box allows user to select the -

1. **Register-Tag** : This is a list of tags available in the application. The list will not display any read only registers that can not be modified.
  2. **Data Type** : This selects the type of data to be entered. Choices are Unsigned Integer, Signed Integer, Hexadecimal, BCD, Binary (1 word), Float.
  3. **Format** : Determines the format of the data to be displayed.
  4. **Low-limit** : Data entered can be limited by assigning Low limit.
  5. **High-limit** : Data entered can be limited by assigning High limit.
  6. **1st-operation** : User can define math operations like addition(+), subtraction(-), multiplication(\*), Division (/). By default selection is NOP i.e. no operation.
  7. **2nd- operation** : User can define math operations like addition(+), subtraction(-), multiplication(\*), Division (/). By default selection is NOP i.e. no operation
-

8. **Popup** : If user wants to enter data with popup keypad then user has to check **Keypad** option and also select popup screen number from list. If user don't want popup data entry then he has to add static numeric keypad object on screen .

**Note:-** Math operations operate only on unsigned values and unsigned result e.g. If first operation is divided by 100 and tag value is 25 then result will be stored as zero and not 0.25.

Click 'Ok' button to add the object on screen.

### 5.1.3 Display Data

#### Procedure

1. Click on 'Display Data' from object toolbar. The mouse pointer will change to the tool shape.
2. Now place the mouse pointer at desired location and click the left mouse button. The data entry dialog box will appear.

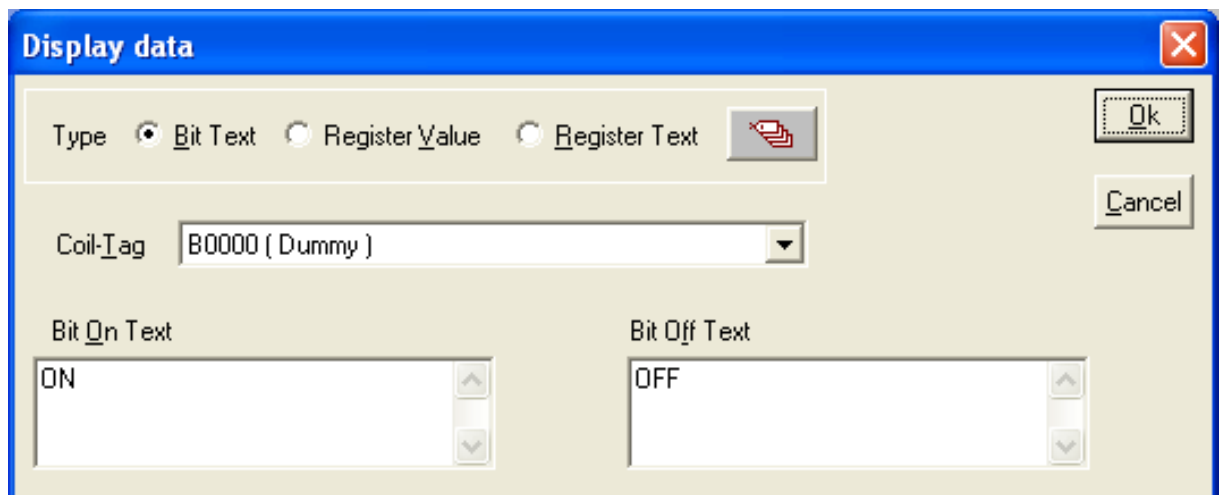

#### Type- Bit Text

This object displays text depending on the bit status.

1. **Coil-Tag** : Select Coil tag from the list.
2. **On Text** : Enter On text maximum up to 40 characters.
3. **Off Text** : Enter Off text maximum up to 40 characters.

Click 'Ok' button to add the object on the screen.

## Representing Data

---

### Type – Register Value

The screenshot shows a dialog box titled "Display data". It contains the following elements:

- Type:** Radio buttons for "Bit Text", "Register Value" (selected), and "Register Text".
- Register-Tag:** A dropdown menu showing "D0005 ( D5 )".
- Data Type:** A dropdown menu showing "Unsigned integer".
- Format:** A dropdown menu showing "#####".
- Leading zeros blank:** A checkbox that is currently unchecked.
- 1st-operation:** Buttons for "NOP", "+", "-", "\*", and "/", followed by an input field and the range "[ 0 to 65535 ]".
- 2nd-operation:** Buttons for "NOP", "+", "-", "\*", and "/", followed by an input field and the range "[ 0 to 65535 ]".

1. **Register-Tag** : This is a list of tags available in the application. The list will not display any read only registers that can not be modified.
2. **Data Type** : This selects the type of data to be entered. Choices are Unsigned Integer, Signed Integer, Hexadecimal, BCD, Binary (1 word), Float.
3. **Format** : Determines the format of the data to be displayed.
4. **Leading zeros blank** : Leading Zeros blank option decides whether zeros preceding the value will be displayed or not. If this option is enabled then register value will be displayed without Leading zeros.
5. **1st-operation** : User can define math operations like addition(+), subtraction(-), multiplication(\*), Division(/). By default selection is NOP i.e. no operation
7. **2nd-operation** : User can define math operations like addition(+), subtraction(-), multiplication(\*), Division(/). By default selection is NOP i.e. no operation.

### Type – Register Text

This object displays text depending on value of a register. User can define different text for different ranges.

Display data

Type  Bit Text  Register Value  Register Text

Register-Tag D0005 ( D5 )

Low limit	High Limit	Text
10	100	Cycle1
101	200	Cycle2
201	300	Cycle3

Define new range

Low Limit High Limit Text

301 400 Cycle4

[ 0 to 65535 ] [ 0 to 65535 ]

Accept Discard

1. **Register-Tag** : This is a list of tags available in the application. The list will not display any read only registers that can not be modified.
2. **Show table** : Table shows list of text string defined for different ranges.
3. **Define new range** : User can define new range with low and high limits and text in following edit box.
4. **Delete** : User can delete entry from table.
5. **Accept** : Using this button edited range is accepted and added in the table.
6. **Discard** : Using this button edited limit and text is disabled.

Click 'Close' button to add object on the screen.

## Representing Data

---

### 5.1.4 Time

1. Click on 'Time' from objects toolbar. The mouse pointer will change to the tool shape.
2. Now place the mouse pointer at desired location and click the left mouse button.

Object is placed in default format HH:MM:SS.

User can change format by double clicking on the object.

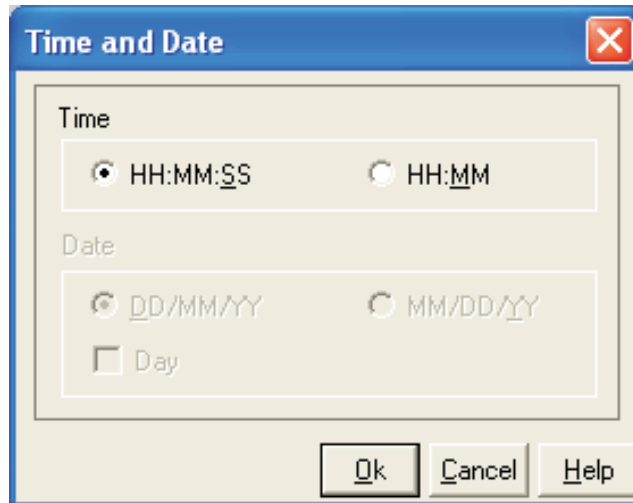

Time is displayed in 24 hour format without leading zeros. If NTXS hardware is without RTC this object will display '?'

### 5.1.5 Date

1. Click on 'Date' from objects toolbar. The mouse pointer will change to the tool shape.
2. Now place the mouse pointer at desired location and click the left mouse button.

Object is placed in default format DD/MM/YY without leading zeroes.

User can change format by double clicking on object.

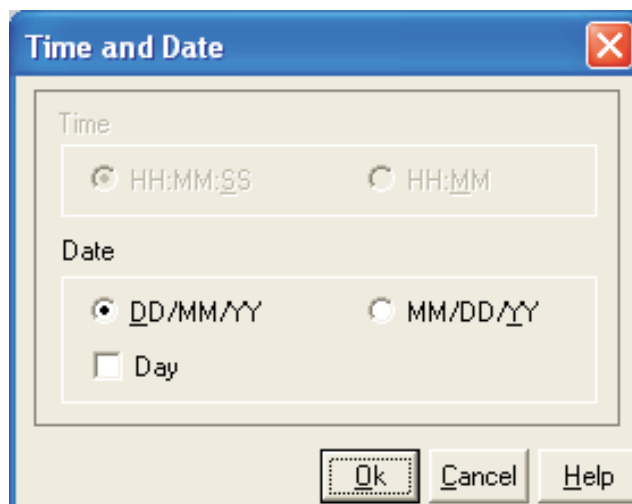

By selecting Day check box day will be displayed ( 'SUN', 'MON'.....).  
If NTXS hardware is without RTC this object will display '?'.



### Attributes of Alphanumeric Objects

#### Font Size

Text objects have four font sizes: 5 X 7 Dots, 7 X 14 Dots, 10 X 14 Dots and 20 X 28 Dots. Default font size is 5 X 7 Dots.

#### Text Foreground:

Text foreground can be changed by user. Two options are available: black and white. Default Text Foreground is Black.

#### Text Background

Text Background can be changed by user. Two options are available: black and white. Default Text Background is white.

#### Border -Single or Double

Any text object can be highlighted using single or double border This enhances its importance.

#### Unconditional Flash

User can assign flashing attribute to any text object. An object can flash at three different speeds: Slow, Medium and Fast. By default no object is assigned the flashing attribute. If flashing is defined, slow flashing is selected by default.

**Note: Data Entry objects (Coil and register) do not have flash attribute.**

Following attributes are available on NTXS Models with Graphic Display.

#### Animation Properties:

All the objects have Animation Properties. Animation Property is a property of an object which changes with the value of the Tag associated with it. Animation Property helps user to create a screen that will have a better user interface. Animation properties are of two types-

1. Show / Hide Animation
2. Flash

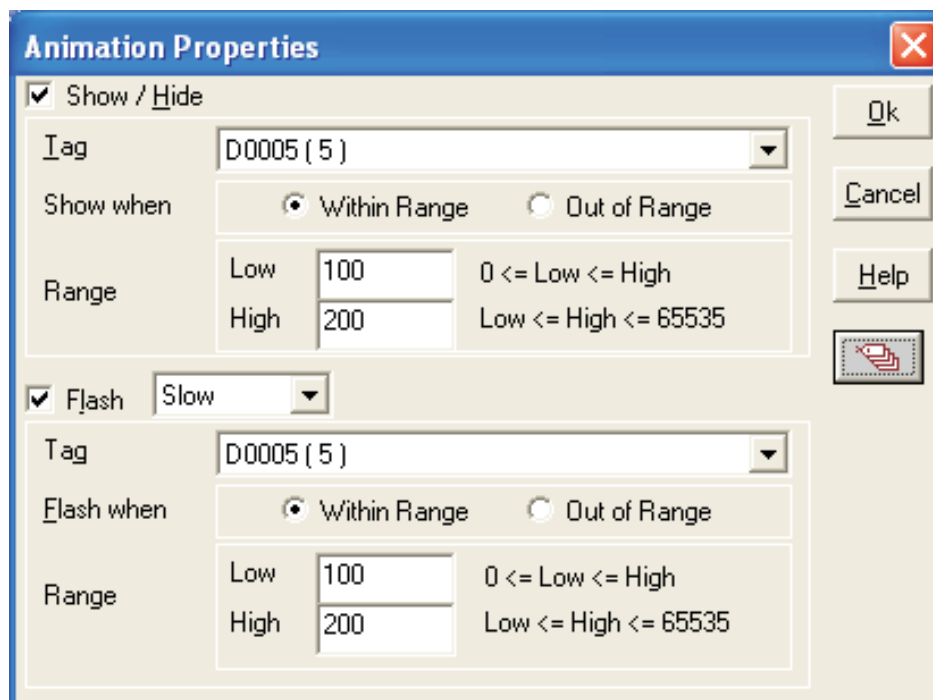

## Representing Data

---

**1. Show / Hide Animation:** Object is displayed only when the condition specified by the user is true. For example, the object is displayed when a value of tag is within 100(Low) and 200(High). When this condition is false, the object is not displayed.

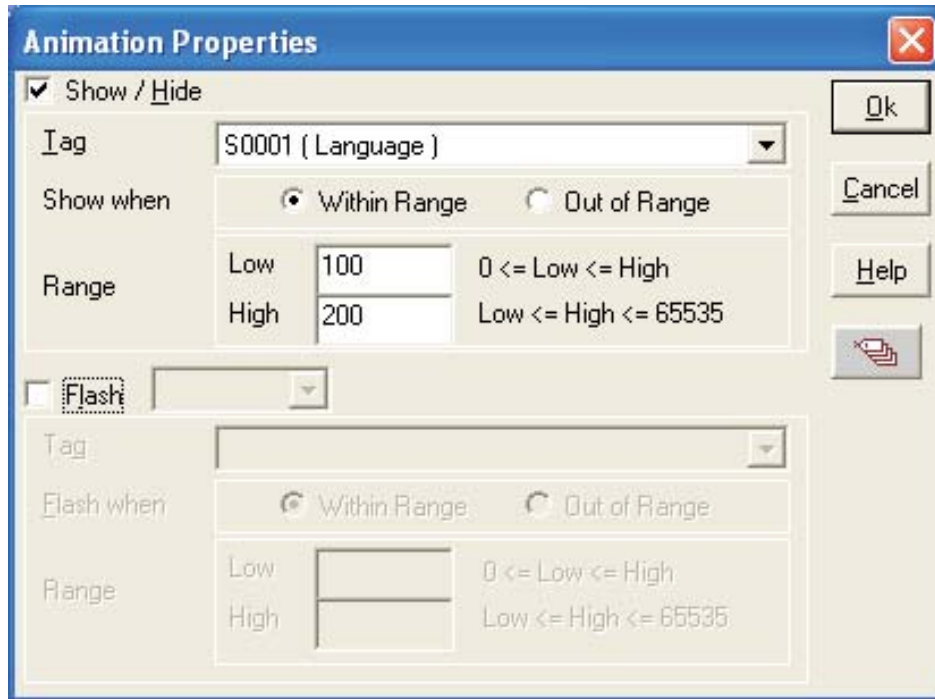

**2. Flashing Animation:** Object can be flashed at three speeds – Slow, Medium and Fast, only when the condition specified by the user is true. For example, object is flashed when a value of tag is within 100(Low) and 200(High). When this condition is false, the object is not flashed.

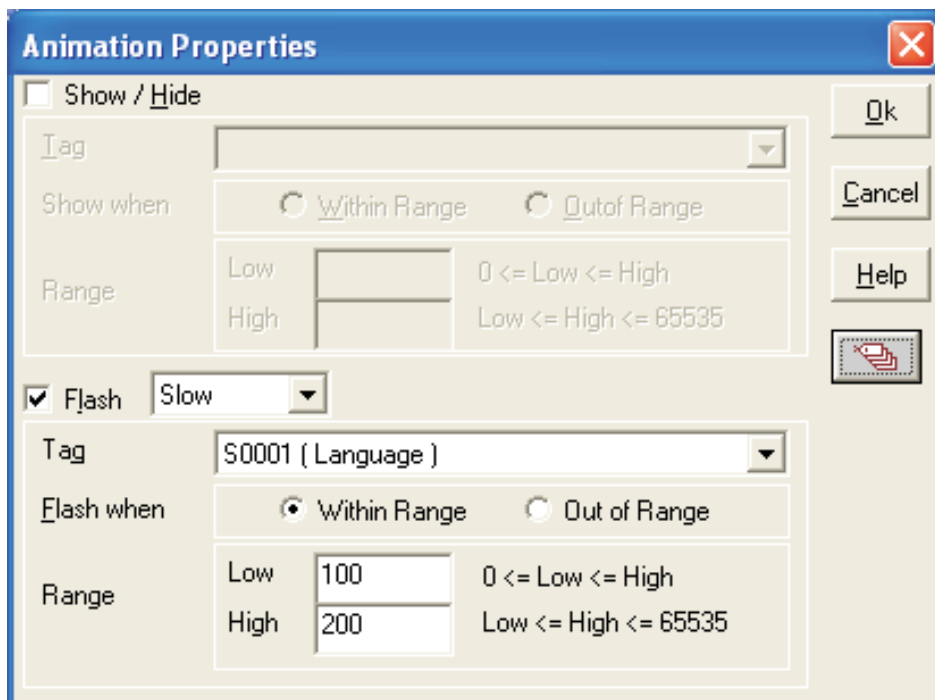

## 5.2 Graphic Wizards

Graphic objects can be used to make the screen more user friendly by drawing pictures. Graphic objects are available only in NT3S units.

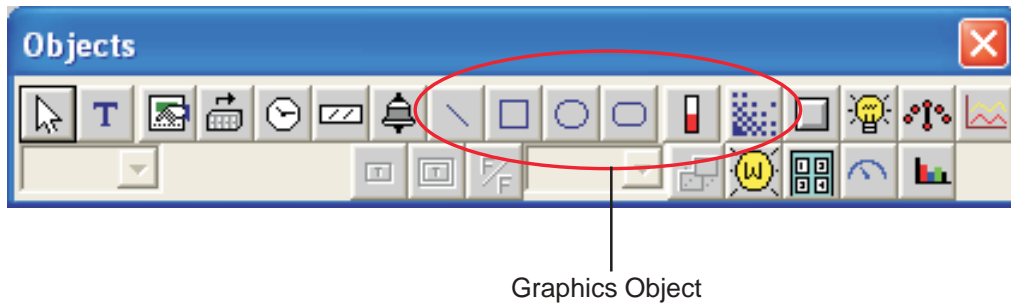

Following are the Graphical Objects :

1. Line
2. Rectangle
3. Ellipse
4. Rounded Rectangle
5. Bargraph
6. Bitmap

### 5.2.1 Line

Draws a line of required length in any direction and at required location.

#### Procedure

1. Click on the 'Line' button in screen Objects Toolbar or Menu option. The shape of the mouse pointer will change.
2. Now place the mouse pointer at the desired location and mark the area of object while holding the left mouse button.
3. Release button to add object on screen.

User can change the dimensions and location by double clicking on object.

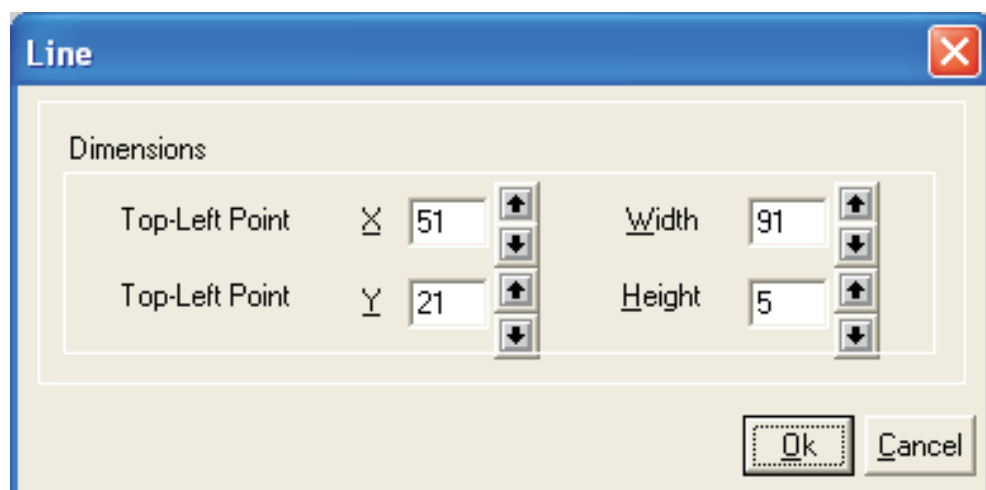

## Representing Data

---

### 5.2.2 Rectangle

Draws a rectangle at the desired location and of required size.

#### Procedure

1. Click on the 'Rectangle' button in screen Objects Toolbar or Menu option. The shape of the mouse pointer will change.
2. Place the mouse pointer at the desired location and mark the area of the object while holding the left mouse button.
3. Release button to add object on screen.

Dimensions and location by double clicking on the object.

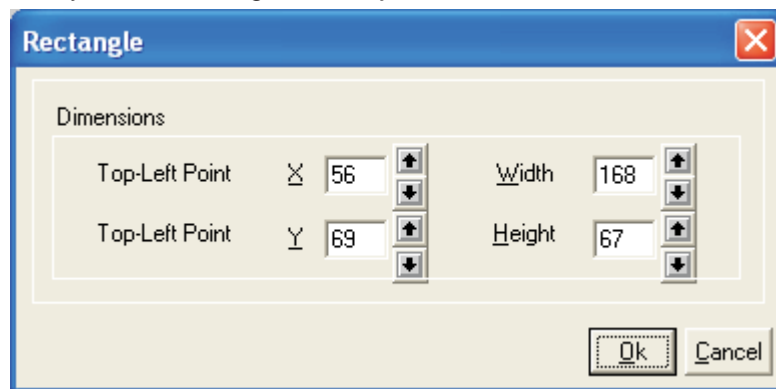

### 5.2.3 Ellipse

Draws an ellipse of the size at the insertion location.

#### Procedure

1. Click on the 'Ellipse' button in screen Objects Toolbar or Menu option. The shape of the mouse pointer will change.
2. Now place the mouse pointer at desired location and mark the area of object while holding the left mouse button.
3. Release button to add object on screen.

The designer can change the dimensions and location by double clicking on the object.

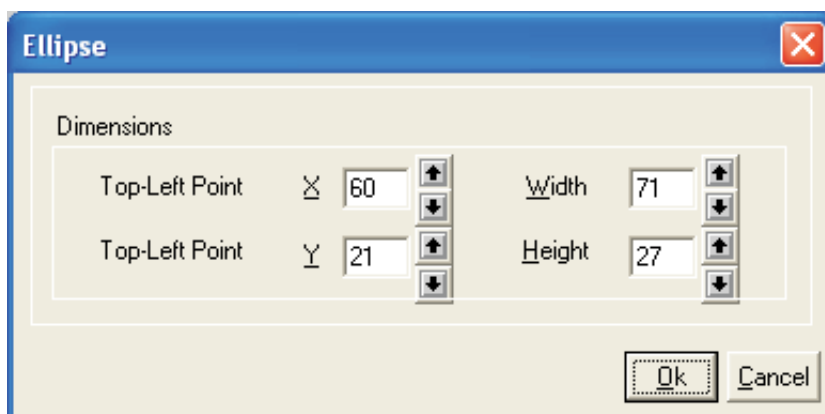

### 5.2.4 Rounded Rectangle

Draws a rectangle with rounded corners. The size and location can be varied.

**Procedure**

1. Click on the 'Round Rectangle' button in screen Objects Toolbar or Menu option. The shape of the mouse pointer will change.
2. Now place the mouse pointer at desired location and mark the area of object while holding the left mouse button.
3. Release button to add object on screen.

The designer can change the dimensions and location of the object by double clicking on the object.

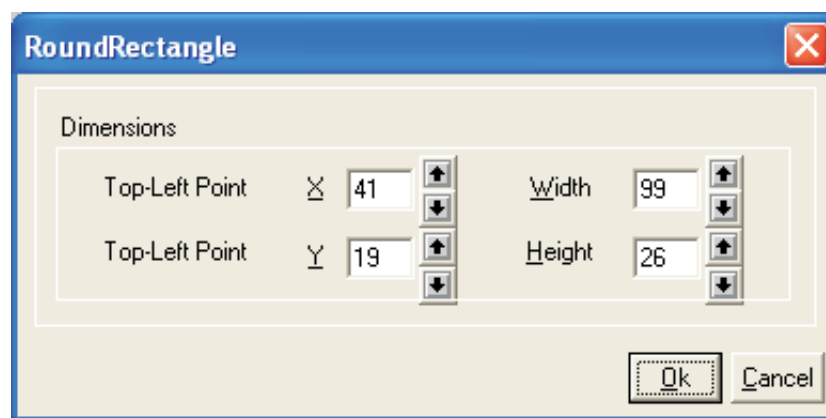

### 5.2.5 Bargraph

Bar graphs are register dependent objects which change their bar height or width according to the value in the register.

**Procedure**

1. Click on the 'Bargraph' button in screen Objects Toolbar or Menu option. The shape of the mouse pointer will change.
2. Now place the mouse pointer at desired location, the following window will appear.

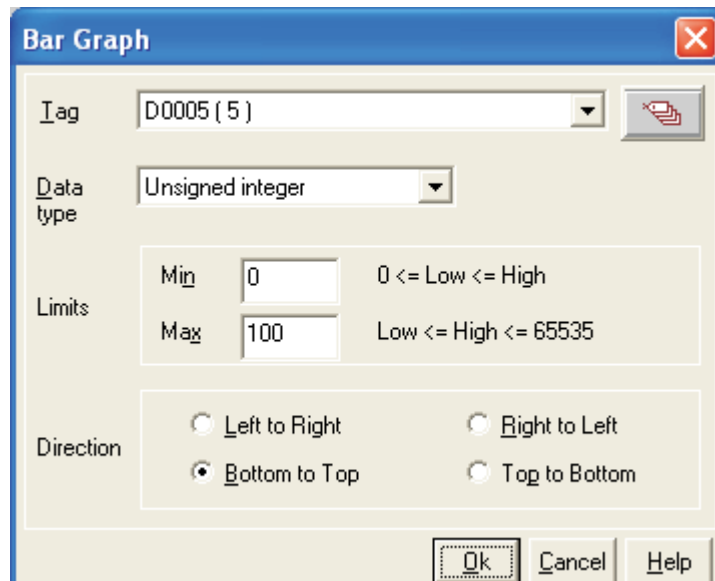

## Representing Data

---

1. **Tag:** This is a list of tags available in the application.

2. **Data type:** This selects the type of data to be entered. Choices are Unsigned Integer, Signed Integer, Hexadecimal, BCD, Binary (1 word), Float.

3. **Limits:** Limits of bar graph are 0 to 65535 for all data types except signed integer for which range for limits is -32768 to 32767.

4. **Direction:** User can define direction of bar graph from four options.

**Note:** Bar graph supports only show/hide animation.  
Click 'Ok' button to add object to the screen.

### 5.2.6 Bitmap

A bitmap can be drawn on the NTXS display. The bitmap should not be bigger than the display size of the NTXS unit.

#### Bitmap Specifications:

Maximum size of bitmaps that can be used for NT3S is 192 pixels (W) X 64 pixels (H).  
Only 2 color bitmaps can be used.

#### Procedure

1. Click on the 'Bitmap' button in screen Objects Toolbar or Menu option. The shape of the mouse pointer will change.
2. Now place the mouse pointer at the desired location and window will appear.

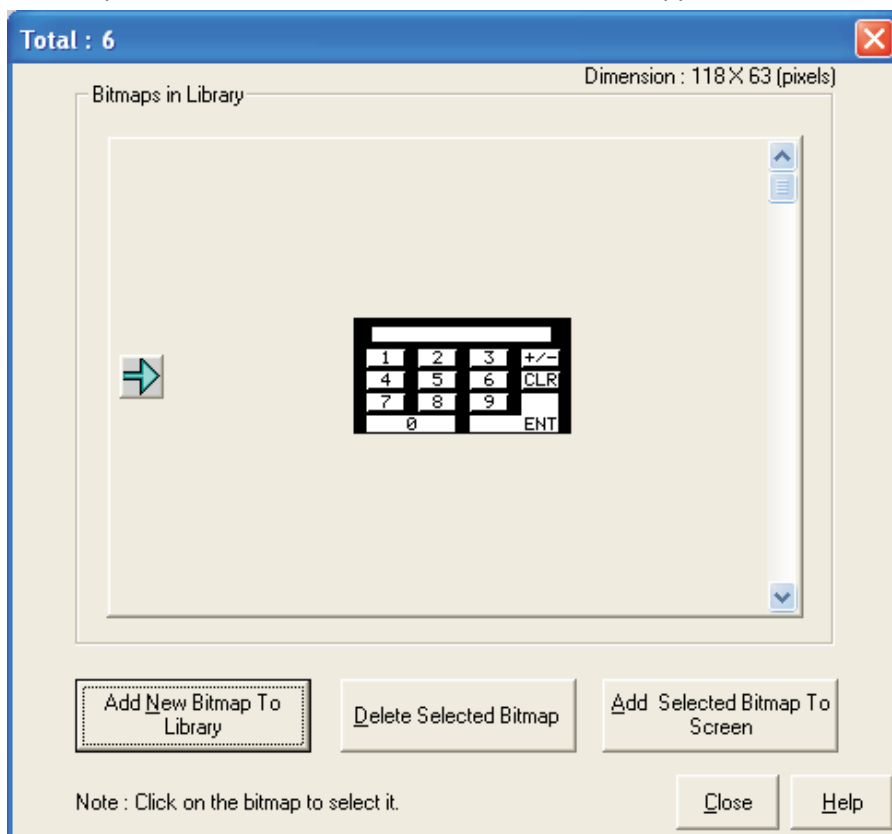

This window shows a list of the currently available bitmaps in the bitmap library.

**Add New Bitmap To Library :** User can add his own bitmap in the library.

**Delete Selected Bitmap :** User can delete selected bitmap from the library.

**Add Selected Bitmap To Screen :** This will add selected bitmap on the screen at desired location

Graphical Objects have certain properties, referred as Attributes. Attributes are useful for suggesting the importance of the particular object.

Basic Graphic Objects have the following attributes:

**Pen Color :** This attribute defines the pattern for drawing the border. For Black and White Graphic display this can either be black or white.

**Fill Color :** This attribute defines the fill color. Any closed object can be filled by the selected color.

**Flash :** All the basic objects can be flashed using this attribute. Flashing can be done at three different speeds: Slow, Medium and Fast.

### 5.3 Wizards

Various wizards included for use in graphical NTXS products are:

1. Button object :
  - a. Bit Button
  - b. Word Button
2. Lamp Object:
  - a. Bit Lamp
  - b. Word Lamp
3. Analog Meter
4. Multiple Bargraph
5. Numeric Keypad
6. Trend Display

## Representing Data

### 5.3.1 Bit Button

The bit button can be used to display the status bit and perform an action based on the task defined for the button.

To draw the object, click on the **Bit Button** icon and place it on the screen.

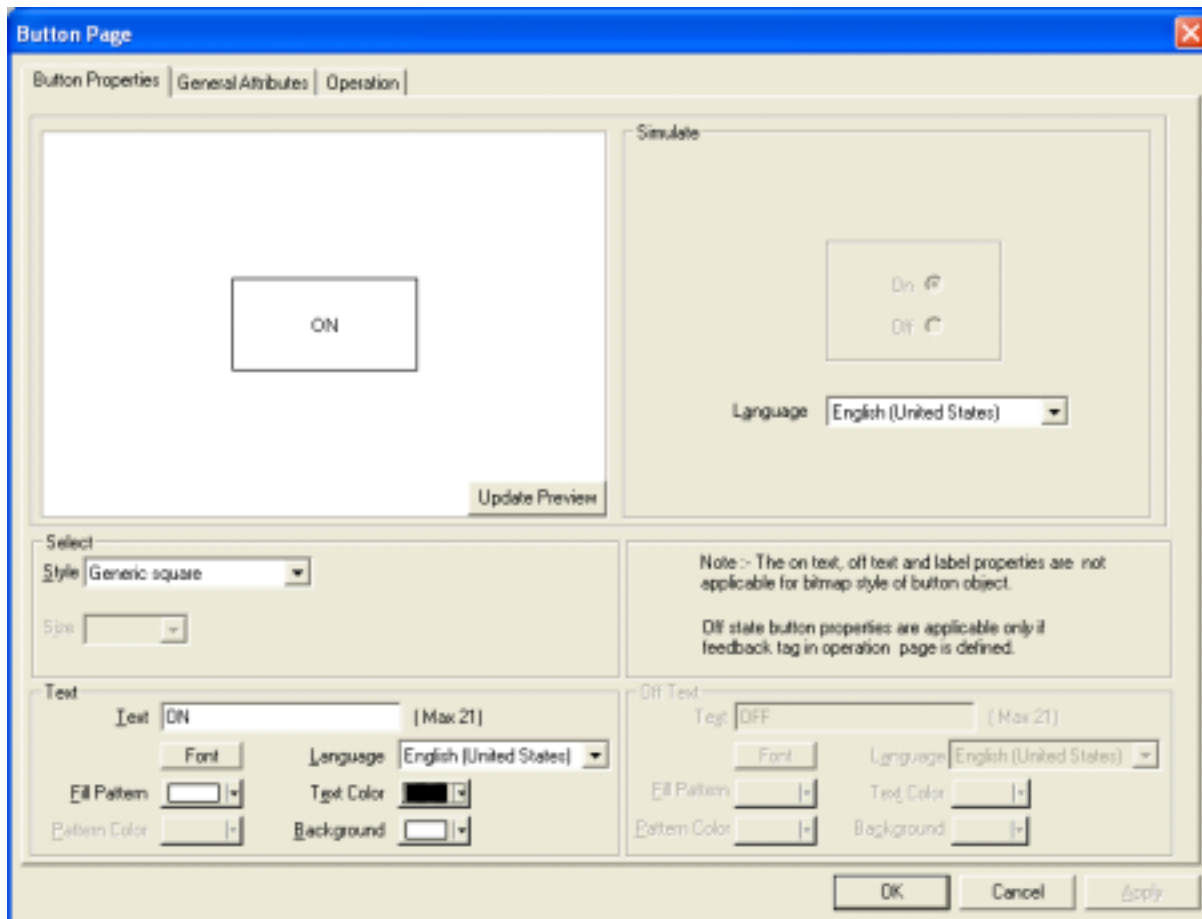

The dialog box window enables the user to select button properties, attributes and operations. Feed back tag status defines the shape of the button, on text, off text. Operation does not vary on the Feedback tag. The presentation of the button on the display is decided by the feedback tag.

**Note:** If the button style is non rectangular, the coordinates of the bounding rectangle are the coordinates of the object. In that case please press inside or on the exact boundary of the button.



### Button Properties:

#### Style

A button can have a number of different styles:

1. Generic square
2. Generic circle
3. Generic rounded rectangle
4. Invisible button
5. User defined image

#### On/Off Text

A button can also be configured with the following properties:

1. **Text** : On / Off text, can be up to 21 characters.
2. **Font** : Select Windows® font, font style and font size. Any font supported in the user's computer is acceptable.
3. **Language** : Display the list of languages depending upon the number of languages configured in the unit settings.
4. **Fill Pattern** : If the display style is a generic square, circle, or rounded rectangle; then the user can define different types of fill patterns for that style.
5. **Text Color** : Color of the text.
6. **Background** : Background color of text.

#### Simulate

The user can simulate the ON and OFF text in various languages as configured in the wizard. These can be previewed in the preview window.

### General Attributes

#### Label selection

Parameters related to the bit button label can be configured if the Label selection is ON. (Check box 'Label' is selected).

1. **Text** : Label text, can be up to 21 characters.
2. **Font** : User can select windows® Font, Font Style and Font size.
3. **Language** : Display the list of languages depending upon number of languages configured in the Unit settings.
4. **Pattern** : User can select different fill patterns for label.
5. **Text Color** : Color of the text.
6. **Background** : Background color of text.
7. **Label position** : If the "Top" option is selected, then the label is displayed above the button as shown above. If the "Bottom" option is selected, then the label is shown at the bottom of the button.

## Representing Data

---

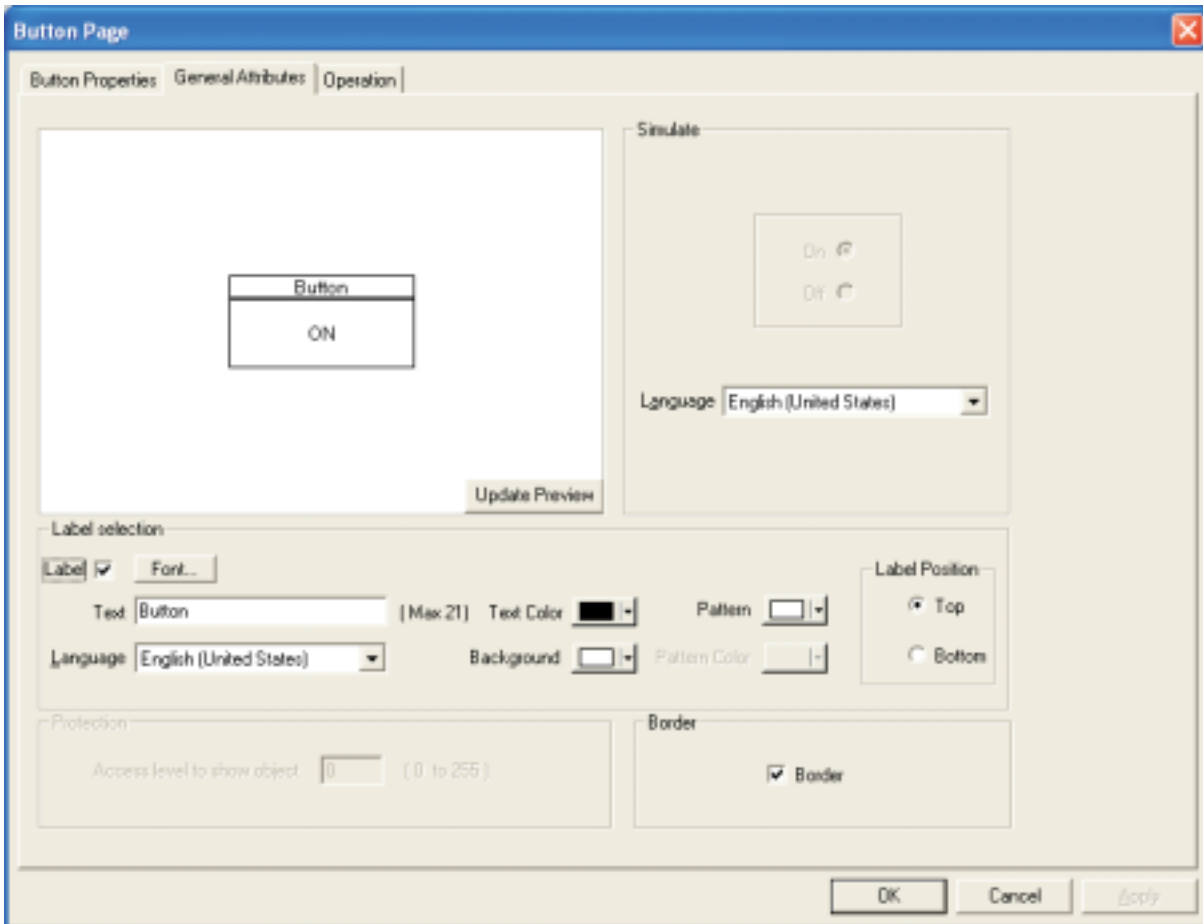

### Border

If the '**Border**' option is selected (through check box), then the button is shown with the border.

### Simulate

The designer can simulate the ON and OFF text in various languages configured in the wizard, and can see its preview in the preview window.

Operation

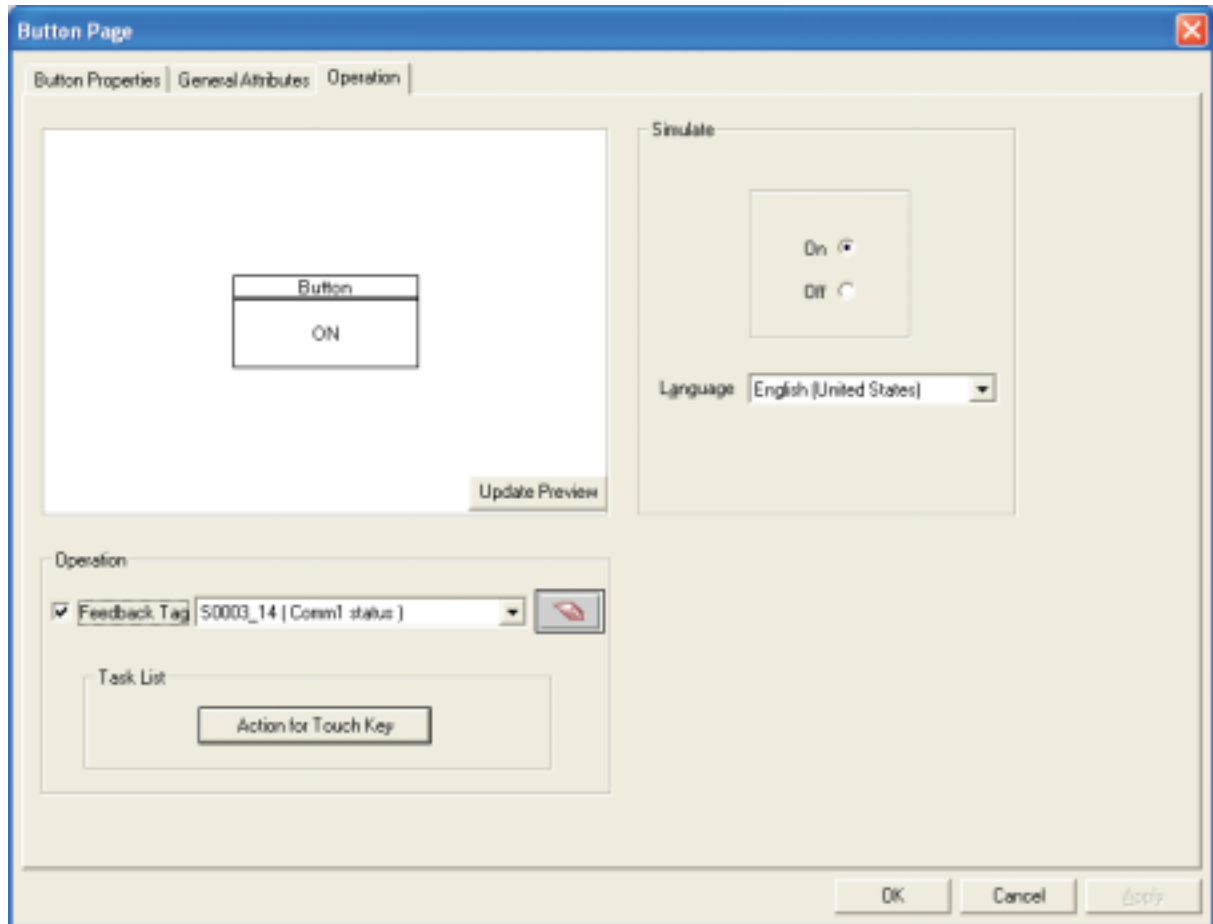

Operation

**Feedback Tag** : If the button has the attribute “Feedback Tag” enabled, then the button shows ON and OFF states as defined in the configuration based on the status of feedback tag. Otherwise, the button displays only the ON state.

Task List

A bit button can be configured to perform tasks depending on the state of the button by clicking on **Action for Touch Key** button. When user clicks on this button, Touch-Screen Task-list window appears for defining the tasks.

- 1. **Press Tasks** - These tasks are performed only once when the button is pressed.
- 2. **Pressed Tasks** - These tasks are performed as long as the button is pressed.
- 3. **Released Tasks** - These tasks are performed when the button is released.

## Representing Data

### 5.3.2 Word Button

The word button performs a set of tasks based on the value of a tag register. Any two-byte tag can be defined as the state tag to control the word button.

To draw the object, click on the **Word Button** icon and place the object on the screen.

#### State Properties

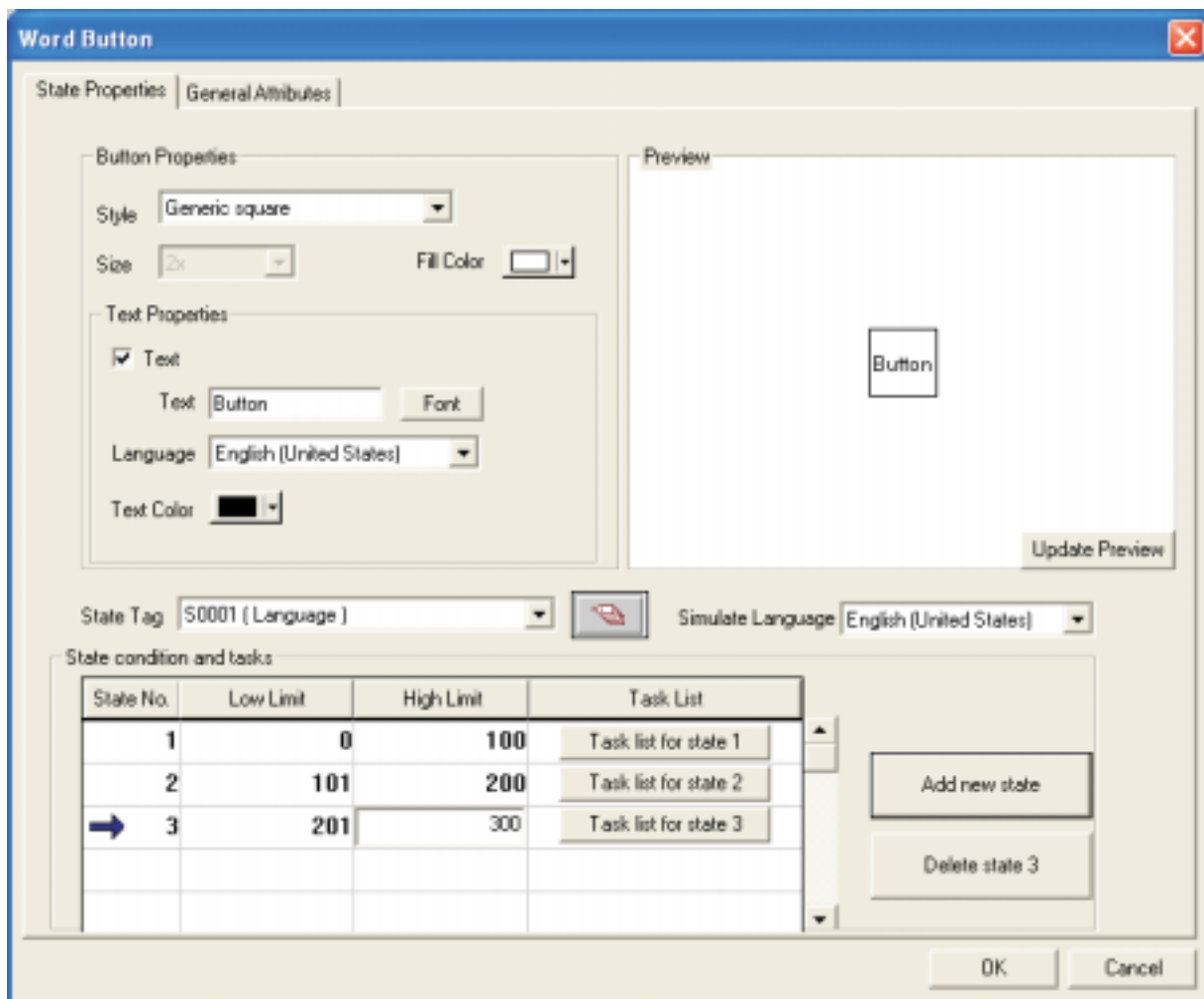

### Button Properties

#### Style

A button can have a number of different display styles:

1. Generic square
2. Generic circle
3. Generic rounded rectangle
4. Invisible button
5. User defined image
6. Check box
7. Radio button
8. Toggle switch

#### Fill Color

Fills the color for each state of the button.

#### Size

If the style is Check box, Radio button or Toggle switch then user can have button size either 1x or 2x.

#### Text Properties

The designer can select different text strings for each state if the text option is enabled.

1. **Text** : Button text.
2. **Font** : User can select Windows® Font, Font Style and Font size.
3. **Language** : Display the list of languages depending upon number of languages configured in the Unit settings.
4. **Text Color** : User can select the color of the text.

#### State Tag

This tag is used to determine the present state of the word button. This can be either unit tag or PLC tag.

#### State conditions and tasks

This table gives information about the various states defined by the word button with their corresponding low and high limits and the task list for each range. The user can assign tasks to any of the defined states by clicking on the Task List button for the corresponding state. Up to 32 different states can be defined.

#### Add new state

Add a new state by clicking this button.

#### Delete state

Delete an existing state by high lighting it and pressing this button.

#### Simulate

The designer can simulate various languages configured in the wizard. Previews of each language can be simulated.

## Representing Data

---

### General Attributes

#### Label selection

The word button label can be configured when the Label selection is enabled. (Check box Label is selected).

1. **Text** : Label text.
2. **Font** : User can select a Windows® font, font style and the font size.
3. **Language** : Display the list of languages depending upon number of languages configured in the Unit settings.
4. **Text Color** : User can select color of the text.
5. **Background** : User can select background color of text.
6. **Label position** : If the top option is selected then the label is shown above the button. If the bottom option is selected, then the label is shown at the bottom of the button.

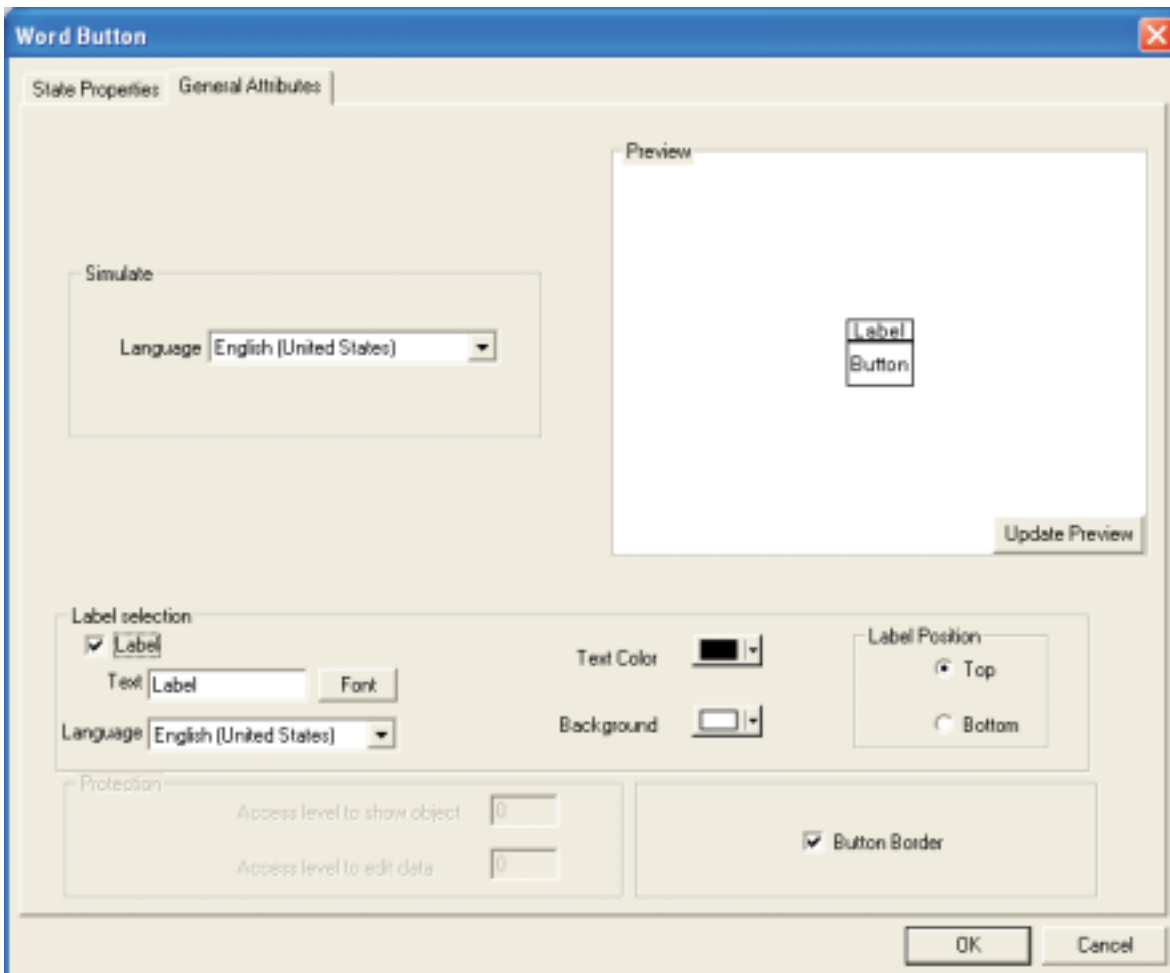

#### Button Border

If the button border is enabled then the button is drawn with a border. This applies only to the “generic” style bit buttons.

#### Simulate

This allows the designer to preview what the button will look like. It is enabled when multiple languages are used or if the Feedback Tag checkbox is checked.

### 5.3.3 Bit Lamp

The bit lamp can be used to display the on/off status of a coil or bit.

To draw the object, click on the **Bit Lamp** button. Place the tool on the screen.

#### Lamp Properties:

A number of predefined lamp styles are available. The On and Off text properties are applicable only for the “generic” styles. The designer may create a custom lamp by selecting the “User defined image” and selecting images for the On and Off properties.

#### Style

1. Generic square
2. Generic circle
3. Generic rounded rectangle
4. User defined image
5. Lamp
6. Indicator
7. LED

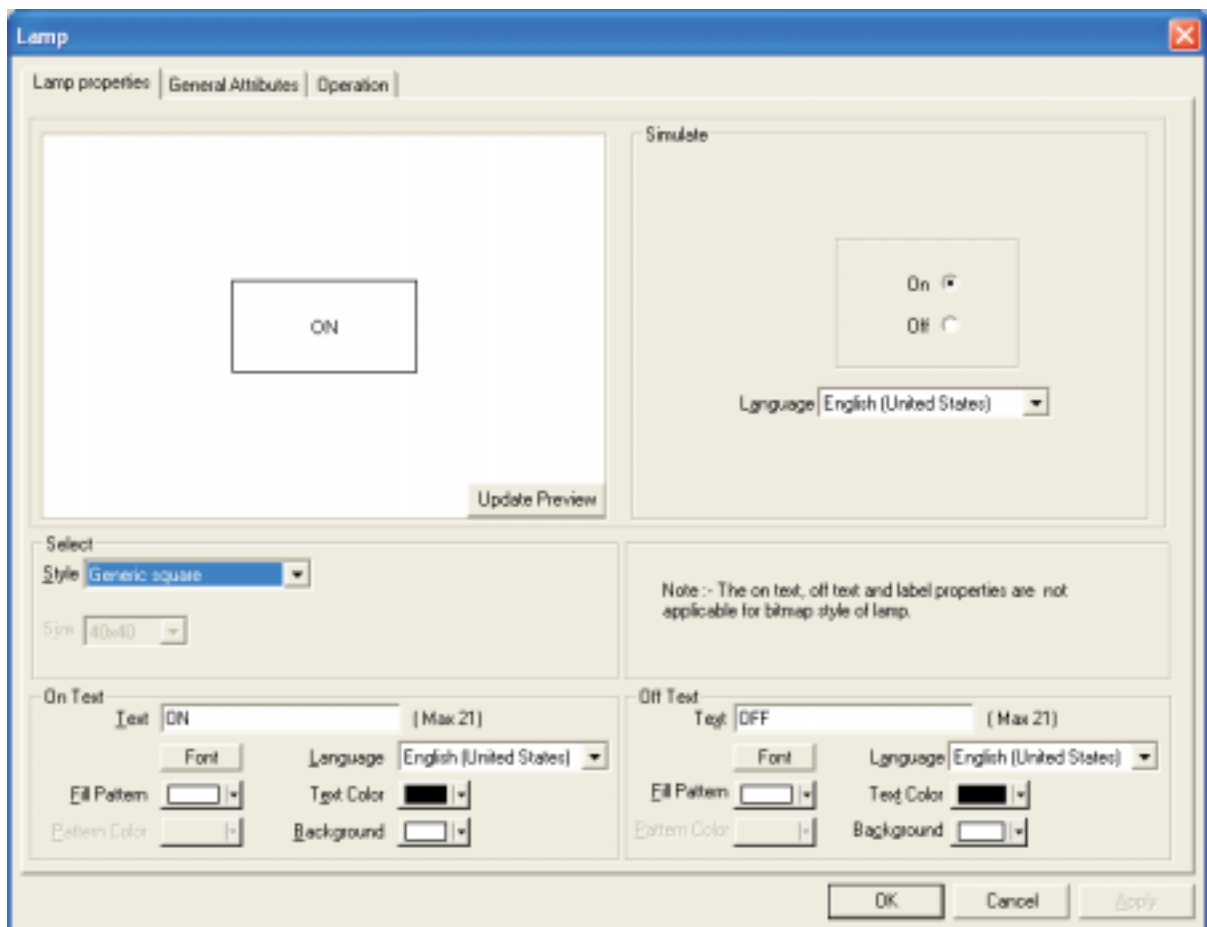

## Representing Data

---

### On/Off Text

Configurable parameters:

1. **Text** : On /Off text, can be up to 21 characters.
2. **Font** : User can select Windows® Font , Font Style and Font size.
3. **Language** : Displays the list of languages depending upon number of languages configured in the Unit settings.
4. **Fill Pattern** : If display style is Generic square; then user can have different types of fill patterns for the style.
5. **Text Color** : User can select color of the text.
6. **Background** : User can select background color of text.

### Simulate

User can simulate the ON and OFF text in various languages configured in the wizard, and can see its preview in the preview window.

### General Attributes

Use this page to define attributes common to all wizards. A preview of the lamp object is displayed in the upper left corner of this page.

### Label selection

Bit lamp label parameters can be configured if the Label selection is enabled by selecting the “Label” checkbox.

1. **Text** : Up to 21 characters can be entered for the label.
2. **Font** : This is used to change the standard Windows® font, font style and font size.
3. **Language** : Displays the list of languages configured in the Unit Settings. When a different language is selected, the label text is entered for that language.
4. **Pattern** : Different fill patterns for the label can be selected.
5. **Text Color** : Select the color for the label text. The “color index” can be used for precise color matching.
6. **Background** : Select the color for the text background. The “color index” can be used for precise color matching.
7. **Label Position** : If the “Top” option is selected, the label is shown above the lamp. If the “Bottom” option is selected, the label is shown at the bottom of the lamp.



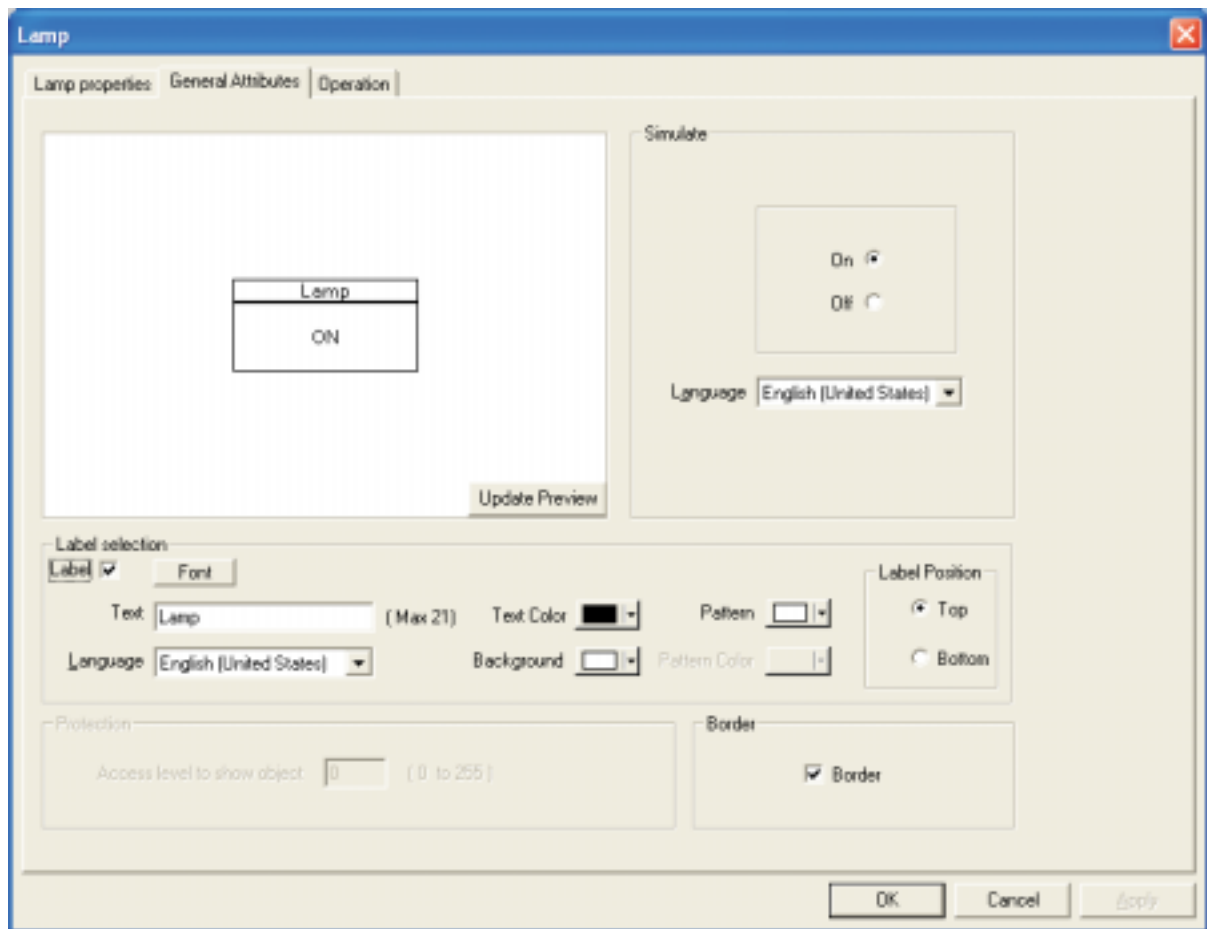

### Border

If the “Border” checkbox is enabled, the lamp is shown with a border. This is the default condition.

### Simulate

This allows the designer to preview how the button will look like. It is enabled when multiple languages are used or if the Feedback Tag checkbox is checked.

## Representing Data

---

### Operation

The Feedback Tag determines which bit tag controls the state of the lamp.

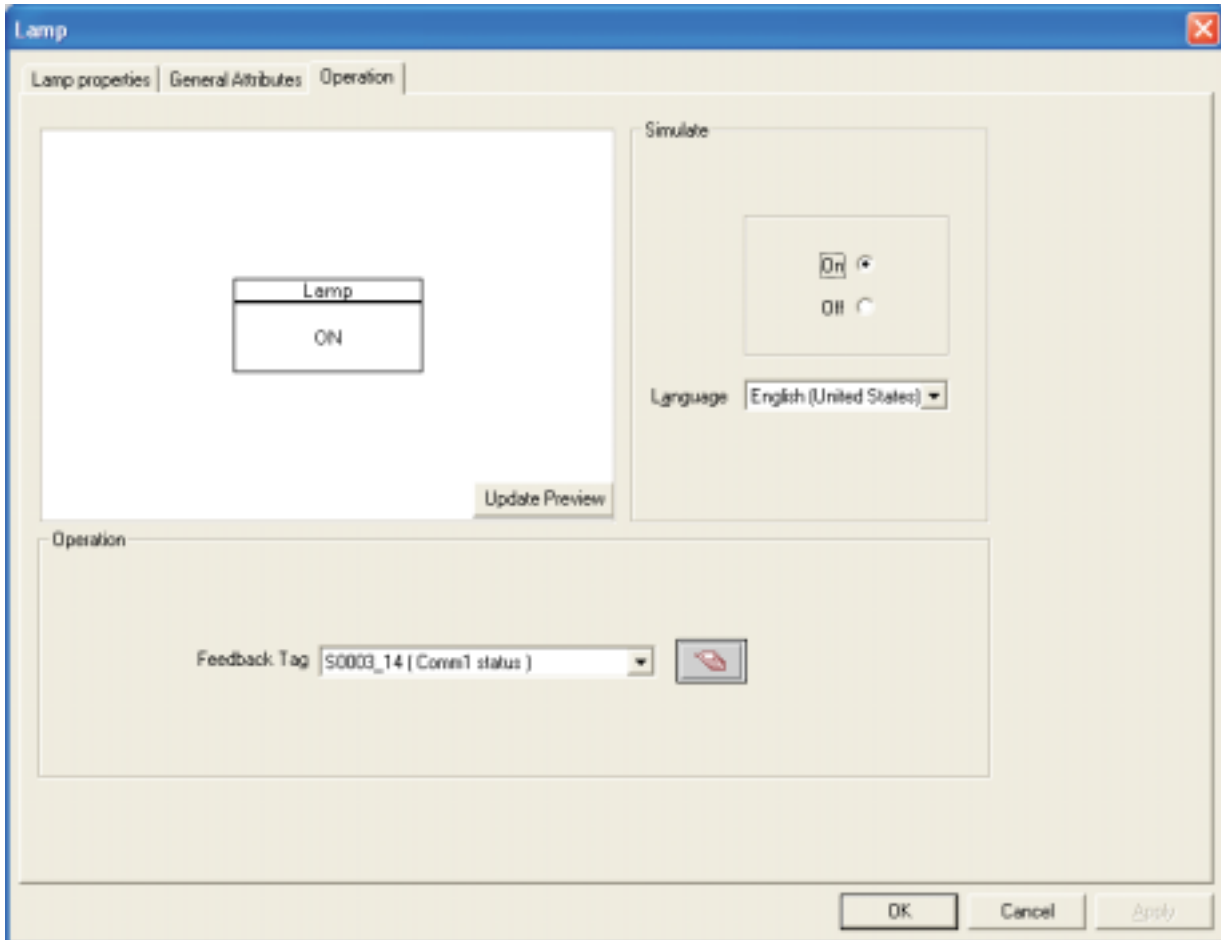

### 5.3.4 Word Lamp

The Word Lamp performs a set of tasks and displays different lamps depending on the value of a register tag. Any two byte tag can be defined as the State Tag. This tag controls the current state of the word lamp.

To draw the object, click on the **Word Lamp** button. Place the tool on the screen.

#### State Properties

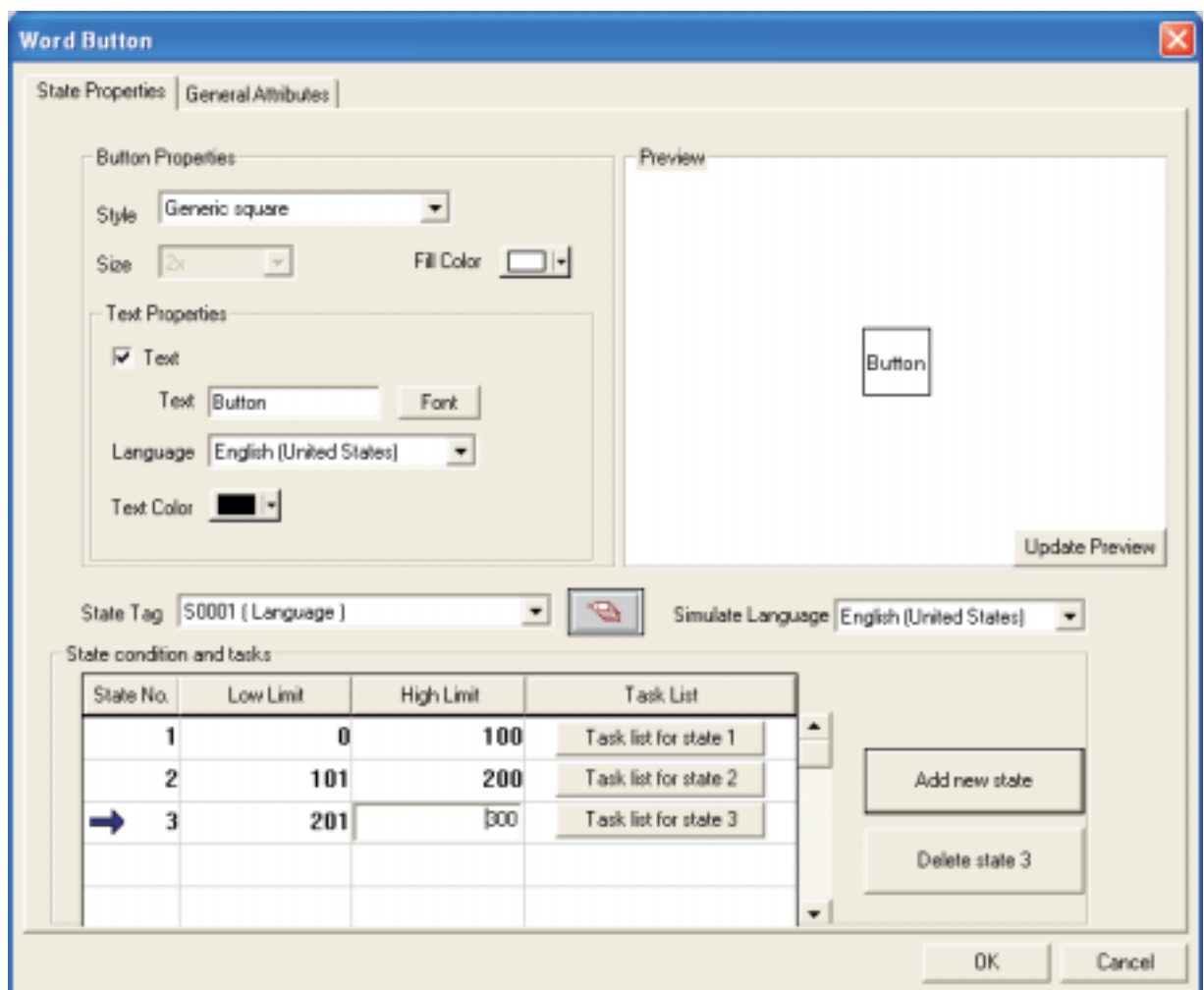

#### Style

Each state can use any one of the different types of display styles. Available styles are:

1. Generic square
2. Generic circle
3. Generic rounded rectangle
4. Invisible button
5. User defined image
6. Lamp
7. Indicator
8. LED

## Representing Data

---

### Fill Color

Select the lamp color for each state.

### Size

If the style is 'Lamp', 'Indicator', or 'LED', the lamp size can be changed from 1x to 2x.

### Text Properties

Different text strings can be specified for each state if the Text option is enabled.

1. **Text** : Up to 20 characters of text can be displayed.
2. **Font** : Used to change the Windows® Font , Font Style and Font size.
3. **Language** : Displays the list of languages depending upon number of languages configured in the Unit settings.
4. **Text Color** : Select the color of the text.

### State Tag

This tag is used to determine the present state of the word lamp. This can be either a NTXS unit tag or a PLC tag.

### State conditions and Tasks

This table is a list of the states defined for the word lamp with their corresponding high and low limits. Up to 32 different states can be defined.

### Add new state

Clicking this button adds a new state to the list.

### Delete state

Select a particular state by highlighting it, and use this button to delete it.

### Simulate

User can simulate various languages configured in the wizard, and can see its preview in the preview window.

### General Attributes

#### Label selection

If the Word Lamp Style is "Generic", then the lamp can have a label by enabling the "Label" checkbox.

1. **Text** : Up to 14 characters of label text can be defined.
2. **Font** : Select the Windows® Font, Font Style and Font size.
3. **Language** : Displays the list of languages configured in the NTXS settings.
4. **Text Color** : Selects the color of the text.
5. **Background** : Selects the background text color.
6. **Label position** : If the "Top" option is selected, the label is shown above the lamp. If the "Bottom" option is selected, the label is shown below the lamp.

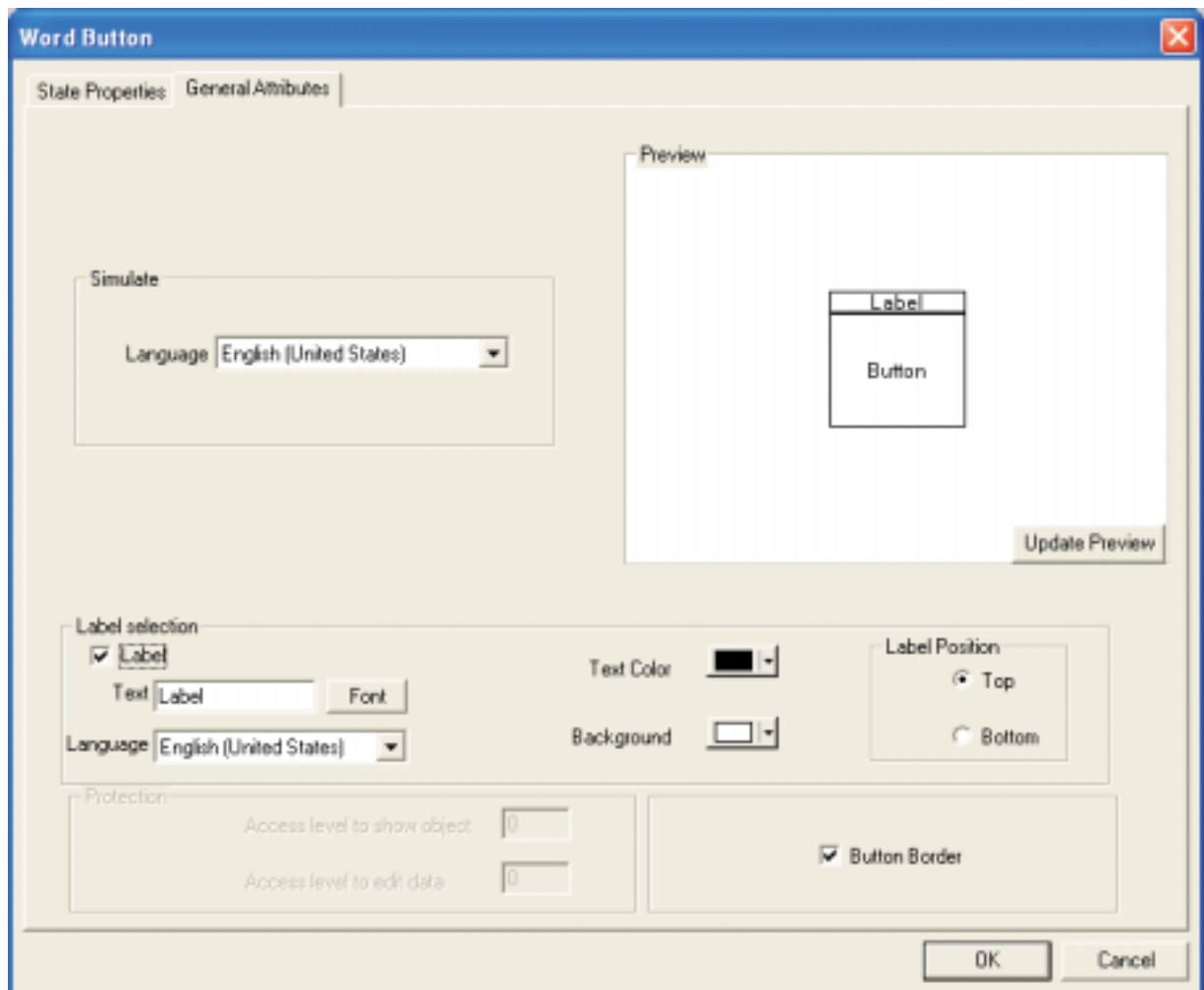

### Button Border

If the “Button Border” check box is enabled, the lamp is shown with a border. This is the default condition.

### 5.3.5 Multiple Bargraph

Bar graphs are register dependent objects which change their height or width according to the value in the register.

This wizard can be configured to view multiple bargraphs (up to 4) simultaneously. Each bargraph can be configured with individual colors and limit values.

To draw the object, click on the **Multiple Bargraph** button. Place the tool on the screen and select the number of bars. The style and width for all bars can be specified. Individual bar properties are set for the bar tag, color, as well as the Maximum and Minimum limits.

## Representing Data

---

### Bargraph Properties

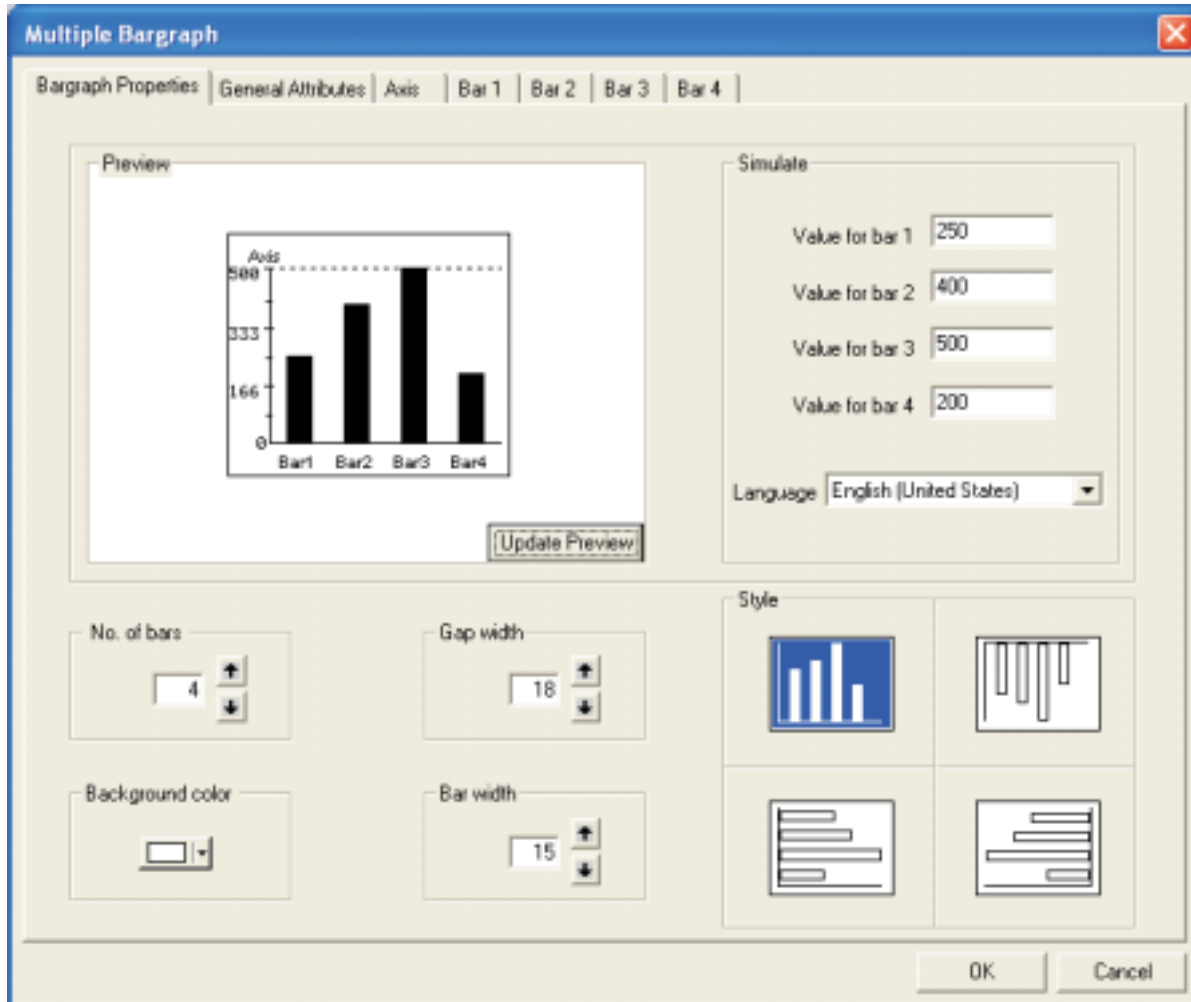

#### Number of bars

Enter or select the number of bars you want in a single wizard. Up to four bargraphs can be defined in a single wizard.

#### Background color

This is the background color for the entire bargraph object.

#### Gap width

The Gap Width is the space, in pixels, between any two bars. The minimum gap width is 0 pixels. The maximum is 28 pixels.

#### Bar width

The designer can specify the bar width, in pixels, for all bars. The minimum gap width is 1 pixel. The maximum is 25 pixels.

### Style

A multiple bargraph object can have any of four different styles.

### Simulate

The designer can preview the bargraph by entering suitable values in the corresponding simulate value field. Changing the “Language” displays the text associated with each language.

### General Attributes

The screenshot shows the 'Multiple Bargraph' dialog box with the following components:

- Preview:** A bar graph titled 'Bar graph' with an 'Axis' on the y-axis. The y-axis has tick marks at 0, 166, 333, and 500. There are four bars labeled 'Bar1', 'Bar2', 'Bar3', and 'Bar4'. The values for the bars are 250, 400, 500, and 200 respectively.
- Simulate:** Four input fields for 'Value for bar 1' (250), 'Value for bar 2' (400), 'Value for bar 3' (500), and 'Value for bar 4' (200). A 'Language' dropdown menu is set to 'English (United States)'. An 'Update Preview' button is located below the preview area.
- Label selection:** A checked checkbox for 'Label', a 'Font' button, a 'Text Color' dropdown (black), and a 'Label Position' section with radio buttons for 'Top' (selected) and 'Bottom'. Below these are 'Text' (Bar graph), 'Language' (English (United States)), and 'Background' (white) dropdowns.
- Protection:** Two input fields for 'Access level to show object' and 'Access level to edit data', both set to 0. A checked checkbox for 'Border' and a 'Data Type' dropdown set to 'Unsigned integer'.
- Buttons:** 'OK' and 'Cancel' buttons at the bottom right.

## Representing Data

---

### Label selection

If the "Label" checkbox is enabled, the designer can specify the following label parameters:

1. **Text** : Label Text. Up to 14 characters of text can be specified for the label.
2. **Font** : Specify the Windows® Font , Font Style and Font size desired.
3. **Language** : Displays the list of languages depending upon number of languages configured in the Unit settings.
4. **Text Color** : Selects the color of the text.
5. **Background** : Selects the background color of the text.
6. **Label position** : If the "Top" option is selected, the label is shown above the bargraph. If the "Bottom" option is selected, the label is shown below the bargraph.

### Border

If the "Border" option is enabled, the bargraph is shown with a border. This is the default condition.

### Data Type

User can have tags of following data types representing values of bargraph :

1. Unsigned integer
2. Signed integer
3. Hexadecimal
4. BCD
5. Float

### Simulate

The designer can simulate the label text of various languages configured in the wizard, and can see a preview in the preview window.



### Axis

#### Axis properties

User can enable or disable axis by clicking on the “Axis” option.

#### Axis color

Color of the axis can be defined.

#### Axis label

Parameters related to the axis label can be configured here if the Label selection is enabled.

1. **Text** : Axis label text. Upto 12 characters of text can be set for the axis label.
2. **Language** : Display the list of languages depending upon number of languages configured in the Unit Settings.
3. **Text Color** : Selects the color of the text.
4. **Background** : Selects the background color of text.

#### Display Range

If enabled, minimum and maximum display range of value scale axis can be specified.

#### Divisions

If enabled, major and minor divisions of value scale axis can be specified.

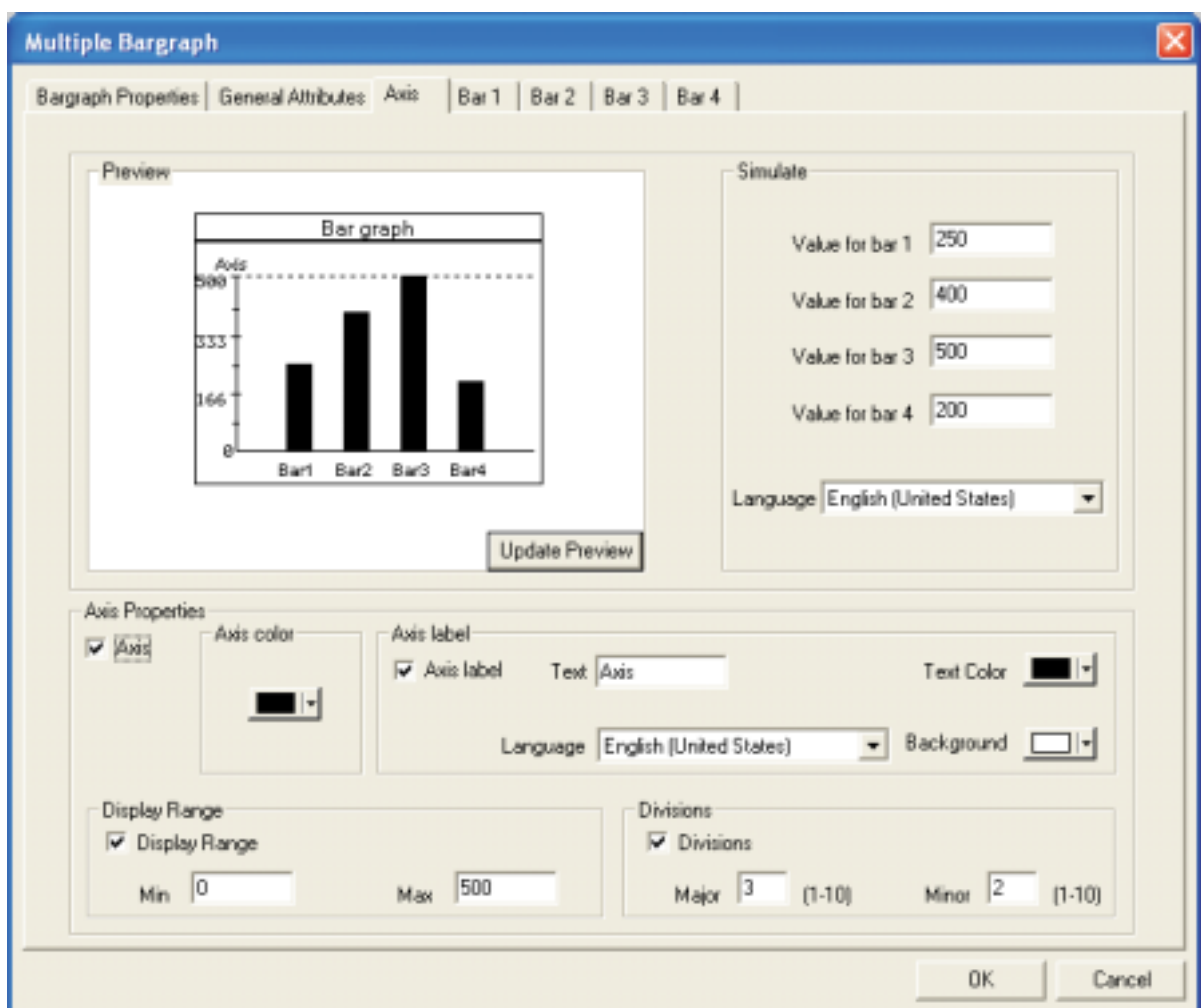

## Representing Data

### Bar <bar number>

#### Bar Properties

1. **Min Tag Value** : Lower limit for the corresponding bargraph.
2. **Max Tag Value** : Higher limit for the corresponding bargraph.
3. **Tag** : A NTXS unit tag or a PLC tag controlling the corresponding bargraph.

#### Bar Color

1. **Line Color** : Border color for the corresponding bargraph.
2. **Fill Color** : Interior color for the corresponding bargraph..

#### Bar Label

Parameters related to the bar label can be configured here if the Bar label selection is enabled.

1. **Text** : Up to 12 characters of axis label text can be defined. Labels may overlap if there is insufficient room..
2. **Language** : Displays the list of languages depending upon number of languages configured in the Unit settings.
3. **Text Color** : Selects the color of the text.
4. **Background** : Selects the background color of text.

**Multiple Bargraph**

Bargraph Properties | General Attributes | Axis | **Bar 1** | Bar 2 | Bar 3 | Bar 4

**Preview**

Bar graph

Axis

500  
333  
166  
0

Bar1 Bar2 Bar3 Bar4

Update Preview

**Simulate**

Value for bar 1: 250  
Value for bar 2: 400  
Value for bar 3: 500  
Value for bar 4: 200

Language: English (United States)

**Bar Properties**

Min Tag Value: 0  
Max Tag Value: 500  
Tag: S0001 [Language]

**Bar Color**

Line Color: [Black]  
Fill Color: [Black]

**Bar Label**

Bar label  
Language: English (United States)  
Text: Bar1  
Text Color: [Black]  
Background: [White]

OK Cancel

### 5.3.6 Analog Meter

The Analog Meter wizard is useful to represent parameter values such as temperature or pressure from a NTXS Unit or PLC tag.

To draw the object, click on the **Analog Meter** button. Place the tool on the screen. This wizard represents the word register on a analog meter. The dialog box has four pages: Meter Foreground properties, Meter Background properties, General Properties, and Operation. Foreground Properties define the number of meter divisions and display range. The Background Properties define needle color, meter style, and range color settings. The General attributes define the label properties and enable or disable the border. The Operation page defines meter start and end angles, control tag and the meter range.

#### Meter Foreground Properties

Meter Foreground properties define the display range and meter divisions.

#### Display Range

If enabled, the values of the minimum display range, maximum display range, and major divisions will be shown on the meter. The limits for the minimum and maximum display range are dependent upon the data type of the tag that is assigned for the meter.

#### Divisions

If enabled, the number of major and minor divisions on the meter scale can be specified.

#### Simulate

The user can simulate the text for the various languages configured in the wizard, the tag value with its corresponding deflection and see a preview in the window.

## Representing Data

---

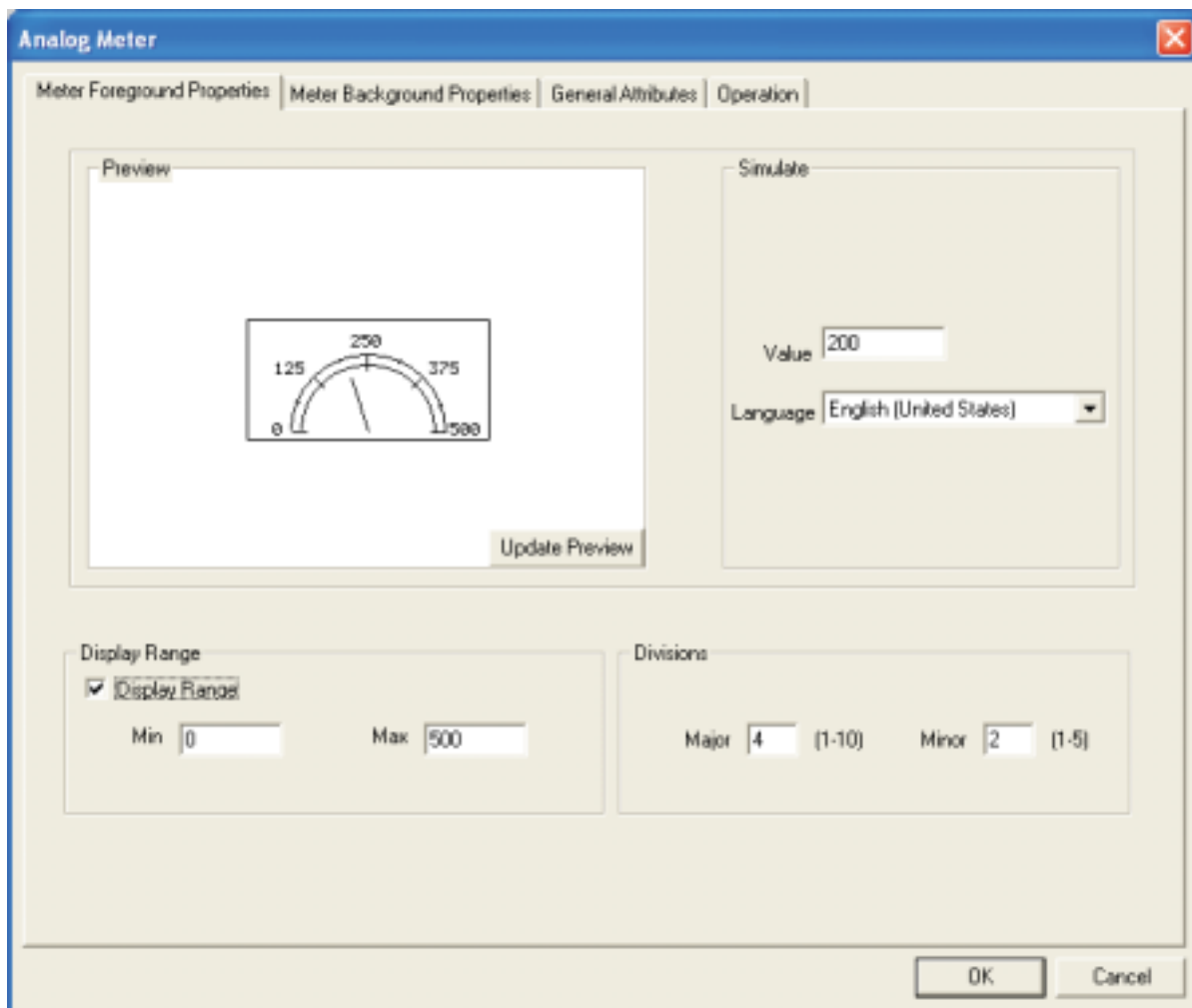

### Meter Background Properties

Meter Background properties define the color settings for needle and meter style.

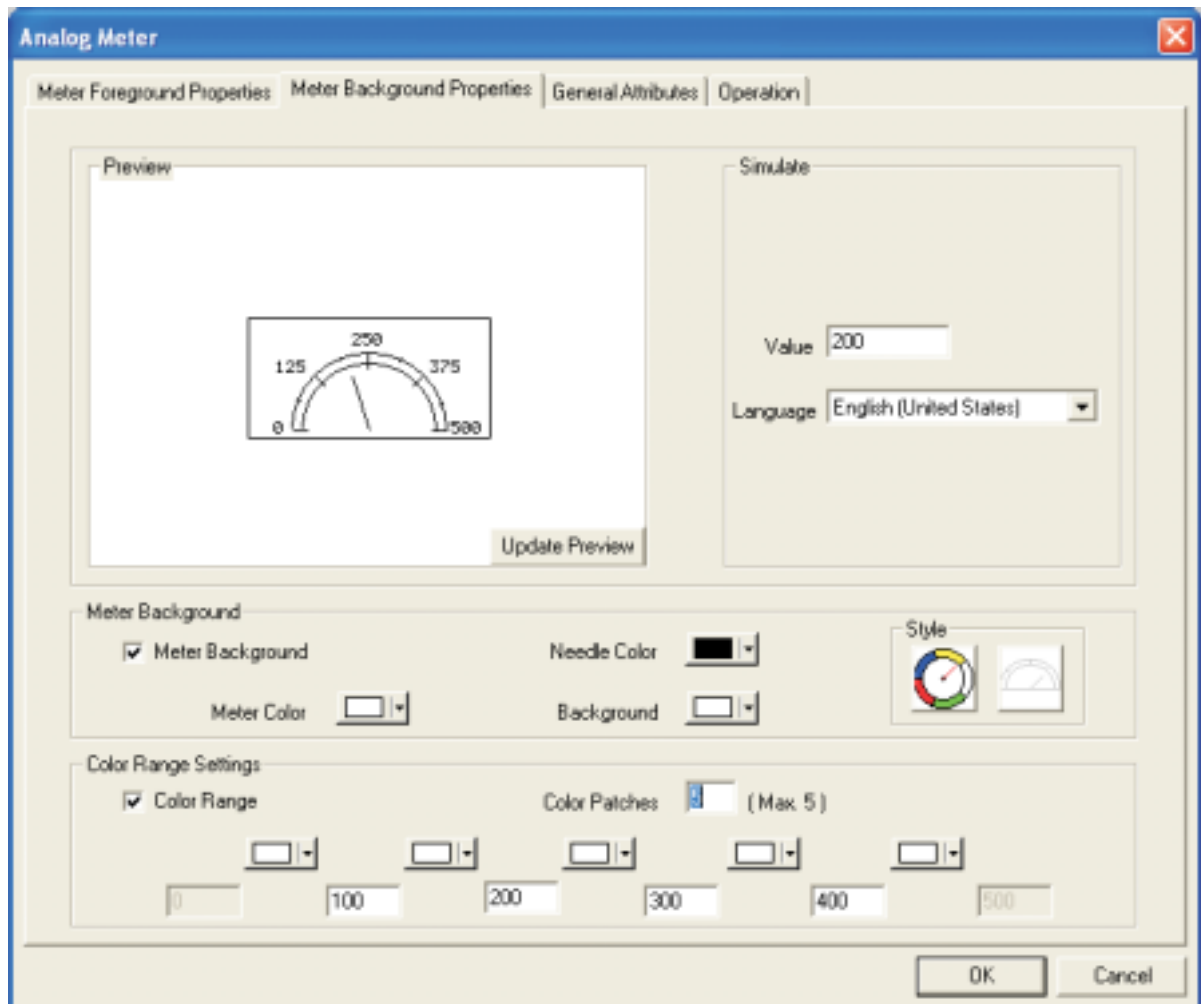

### Color Range Settings

User can set different color ranges, which will represent the sections along the meter axis depending upon the colors set in the configuration. User can have up to 5 different ranges.

Each color range will have

1. **Color Patches** : User can select number of display ranges from here. He can have up to 5 different display ranges.
2. **Color Selection box** : From this user can select the color out of the available for the corresponding unit.
3. **Color limit ranges** : User can assign different values representing different color ranges.

## Representing Data

---

### General Attributes

#### Label selection

Parameters related to the meter label can be configured here if the Label selection is enabled. (Check box 'Label' is selected).

1. **Text** : Up to 14 characters of label text may be specified.
2. **Font** : Select the Windows® Font, Font Style and Font size.
3. **Language** : Displays the list of languages depending upon number of languages configured in the NTXS Unit Settings.
4. **Text Color** : Selects the color of the text.
5. **Background** : Selects the background color of text.
6. **Label position** : If the "Top" option is selected, the label is shown above the meter. If the "Bottom" option is selected, the label is shown below the meter.

#### Meter Border

If the "Meter Border" is enabled, the meter is shown with a border. This is the default condition.

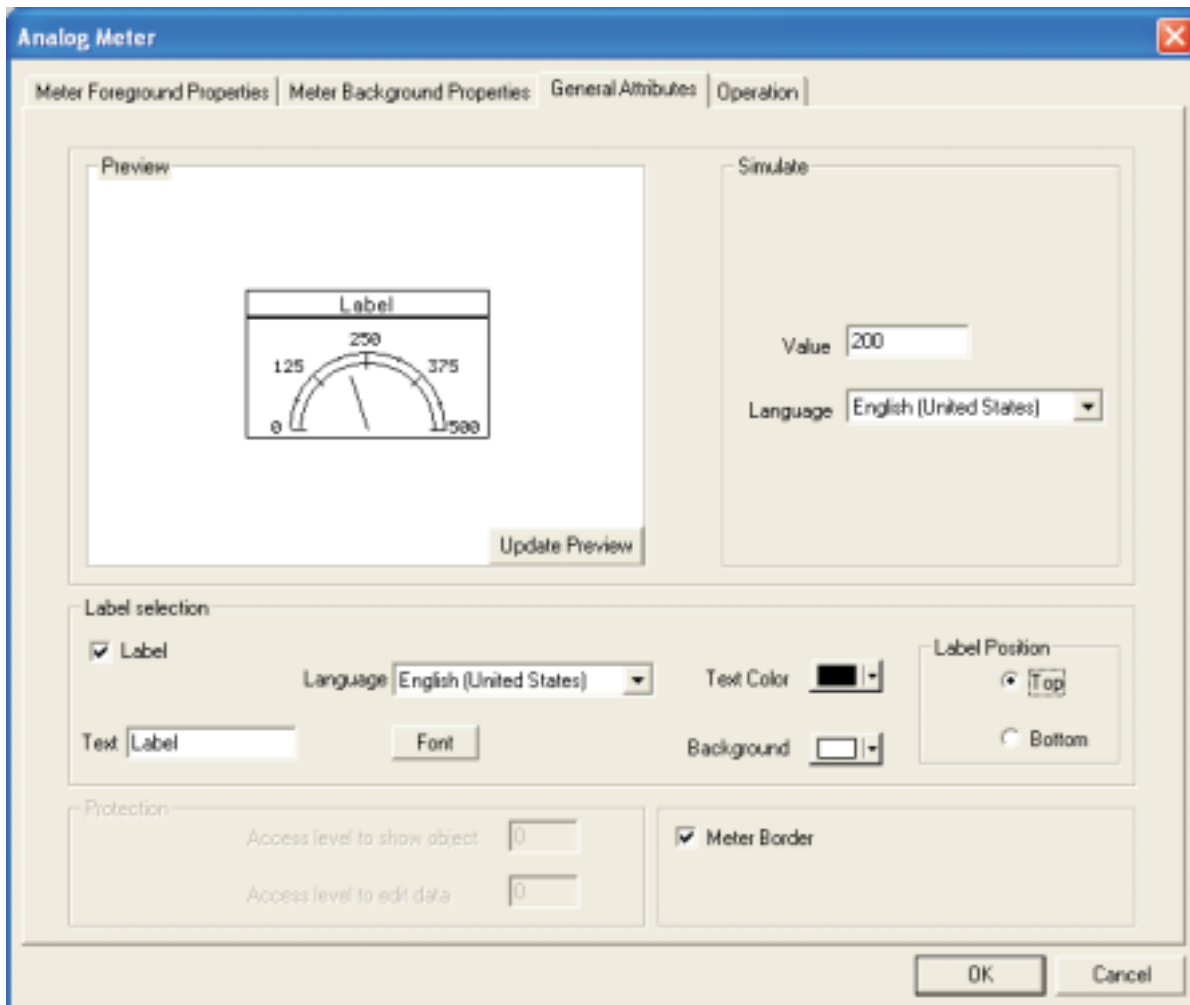

### Operation

#### Meter Operation

1. **Meter Start Angle** : The value indicating the start angle, in degrees, of the meter scale.
2. **Meter End Angle** : The value indicating the end angle, in degrees, of the meter scale.
3. **Start Tag Value** : The minimum value to display on the meter scale.
4. **End Tag Value** : The maximum value to display on the meter scale.
5. **Tag** : A NTXS unit tag or PLC tag that the meter uses for needle deflection.

#### Data Type

The following data types can be used with the meter -

1. Unsigned integer
2. Signed integer
3. Hexadecimal
4. BCD

The meter object only displays a two byte tag.

#### Simulate

The designer can simulate the label text of various languages configured in the wizard and can see a preview in the preview window.

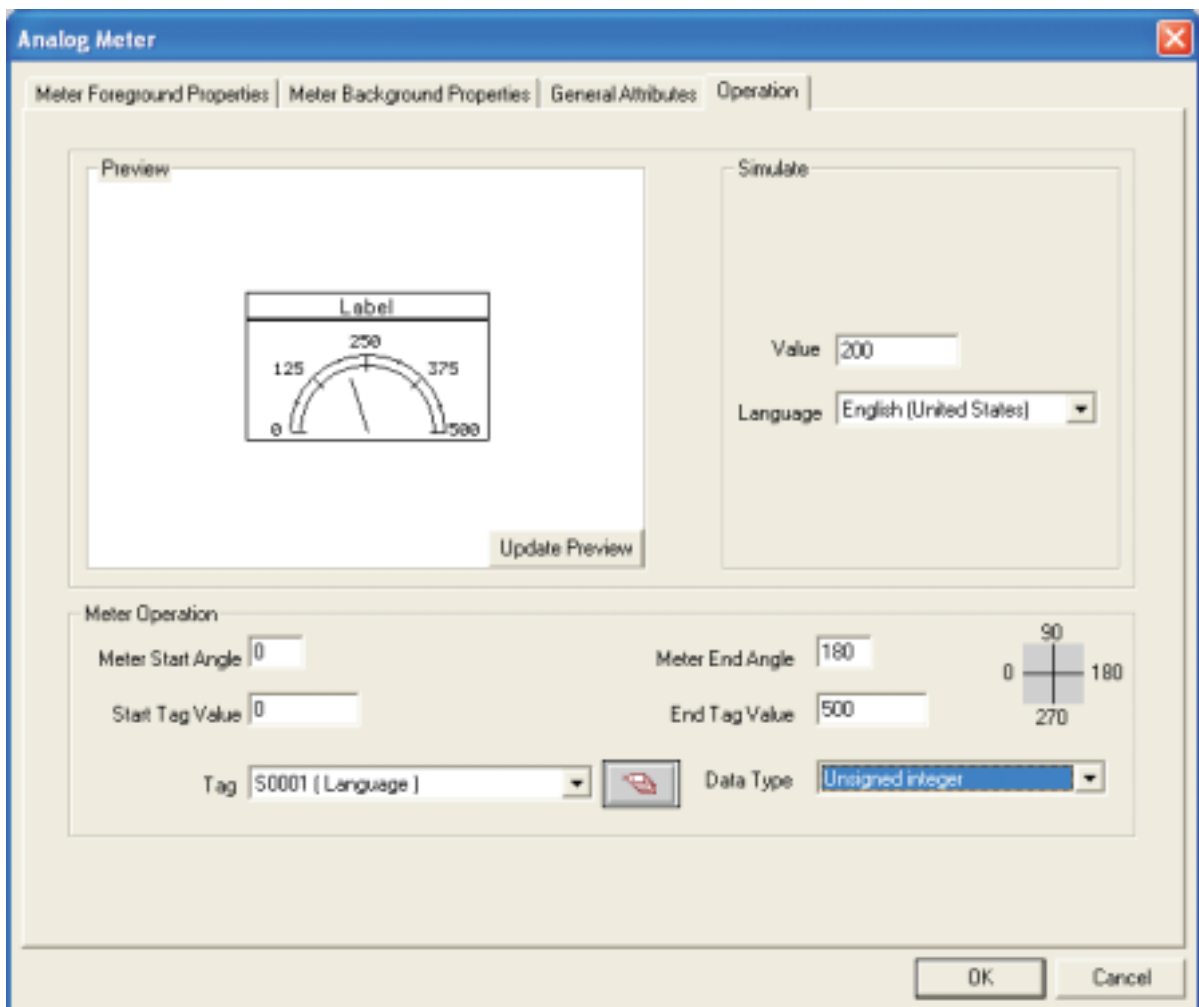

## Representing Data

### 5.3.7 Real Time Trend

The Real Time Trend object is a graphical representation of a tag's value in the current time period. The time value comes from the real time clock in the NTXS unit. The tag's value is plotted on the Y axis and updated every second.

#### Trend Properties

1. **Number Of Tags** : The trends of up to 4 tags can be displayed.
2. **Show Grid** : The Show Grid checkbox determines whether or not the background grid is displayed.
3. **Span Time** : The value, in seconds, representing the span of the X axis. The maximum value of span time is 65535 seconds.
4. **Span Time Tag** : If this option is enabled, the Span Time is controlled by the tag specified.
5. **Fill Color** : The background color of the trend object.
6. **Grid Color** : Select the color of the grids for the trend object.

The screenshot shows the 'Trend' dialog box with the following settings:

- Trend : Properties** (selected tab)
- Preview**: A small graph showing a trend line. Below it is an 'Update' button.
- Trend Properties**:
  - No of tags: 1
  - Time Span: 60 Seconds
  - Fill Color: (white)
  - Error Message: Font: 5x7, Text Color: black
  - Show Grids:
  - Span time Tag:
  - Grid Color: black
- Label**:
  - Label:
  - Language: English (United States)
  - Text: Trend
  - Font...: (button)
  - Color: black
- Data Type**: Unsigned int
- Buttons: OK, Cancel, Apply



### Error Message

Many of the trend object's properties can be determined at run time through the use a tag. If the value of the tag is out of the proper range for the property, an error message will be displayed. The text display properties can be modified.

1. **Font** : Select the Font size. Font size can be either 5 X 7 or 7 X 14.
2. **Text Color** : Color of the error message to be displayed.

### Label

Parameters related to the trend label can be configured here if the Label selection is enabled. (Check box 'Label' is selected).

1. **Text** : Label text.
2. **Font** : Select the Windows® Font , Font Style and Font size.
3. **Language** : Display the list of languages depending upon number of languages configured in the Unit settings.
4. **Color** : Color of the text.

### Data Type

The trend object can have the following data types:

1. Unsigned integer
2. Signed integer
3. Hexadecimal
4. BCD
5. Float

Only 2 byte tags are supported.

## Representing Data

---

### Value Scale Properties

The value scale defines the scaling properties of the Y axis of the trend object.

### Grid Properties

**No of Grids** : Determines the number of horizontal grid lines on the Y axis.

### Limits

If enabled, the Limits selection determines the minimum and maximum values to be displayed on the Y axis.

1. **Minimum** : The smallest displayed value on the Y axis. The range is from 0 to 65,535.
2. **Minimum tag** : If enabled, the minimum is determined by a tag instead of a constant.
3. **Maximum** : The highest displayed value on the Y axis. The range is from 0 to 65535
4. **Maximum tag** : If enabled, the minimum is determined by a tag instead of a constant.
5. **Text color** : The color of the values on the Y scale.

The screenshot shows the 'Trend' dialog box with the 'Value scale properties' tab selected. The 'Preview' area displays a small graph with a y-axis labeled 'Trend' and values 100, 66, 33, and 0. The 'Simulate' dropdown is set to 'English (United States)'. The 'Grid Properties' section shows 'No of Grids' set to 2. The 'Limits' section has 'Units' checked, 'Minimum' set to 0, 'Maximum' set to 100, and 'Text color' set to black. The 'Tag' checkboxes are unchecked, and the 'Tag' dropdowns are set to 'S0001 (Language)'. Buttons for 'Update', 'OK', 'Cancel', and 'Apply' are visible.

Property	Value
No of Grids	2
Minimum	0
Maximum	100
Text color	Black

Time scale properties

Grid Properties

No of Grids : If the grid option is enabled, up to 10 grids can be selected for the X axis display.

Text properties

- 1. **Scale** : If enabled, the real time grid values are shown along the time scale axis.
- 2. **Format** : Scale formatting can be either HH:MM:SS or HH:MM.
- 3. **Color** : Determines the preferred color of the X axis scale information.

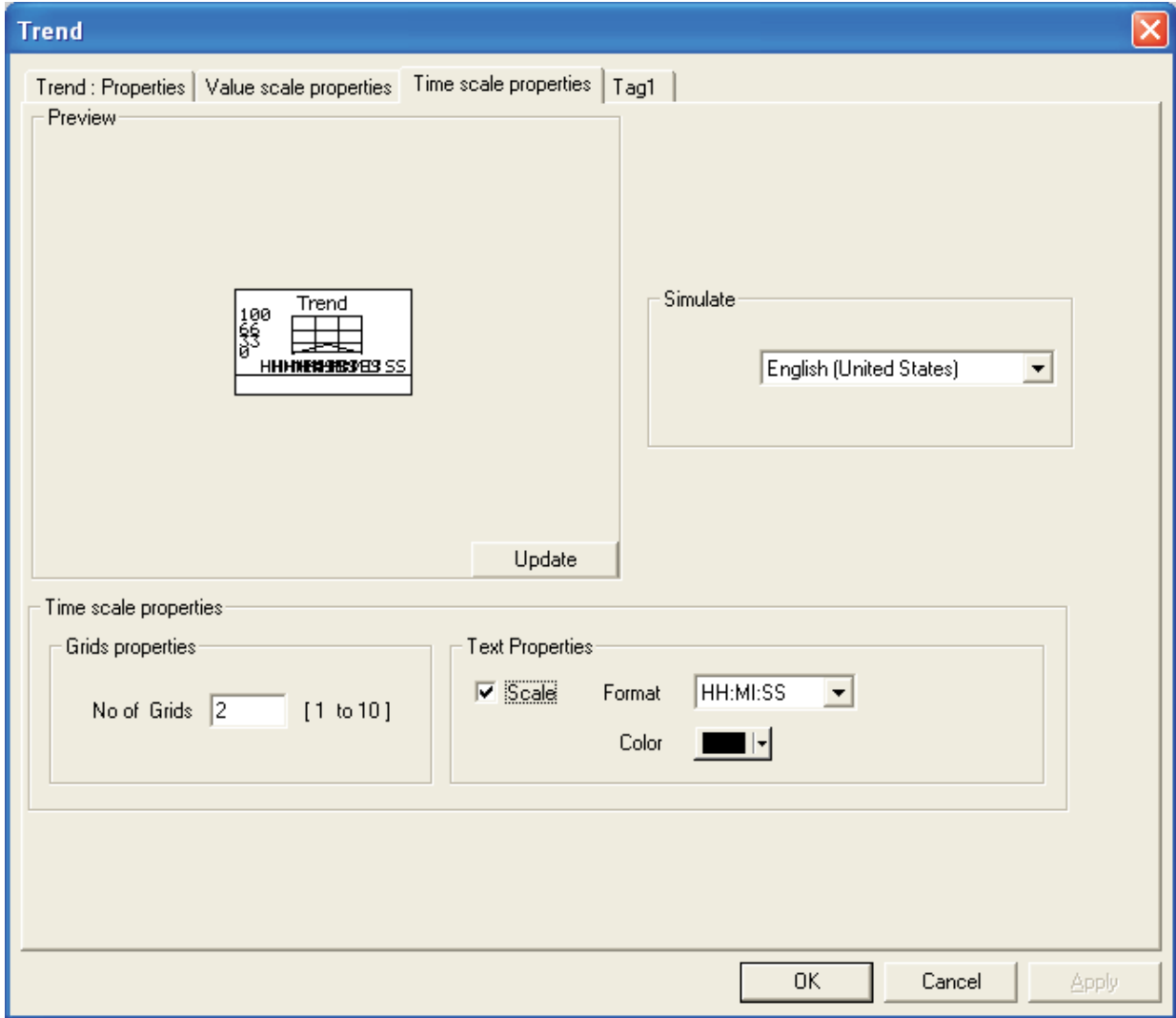

## Representing Data

---

### Specific Tag Information

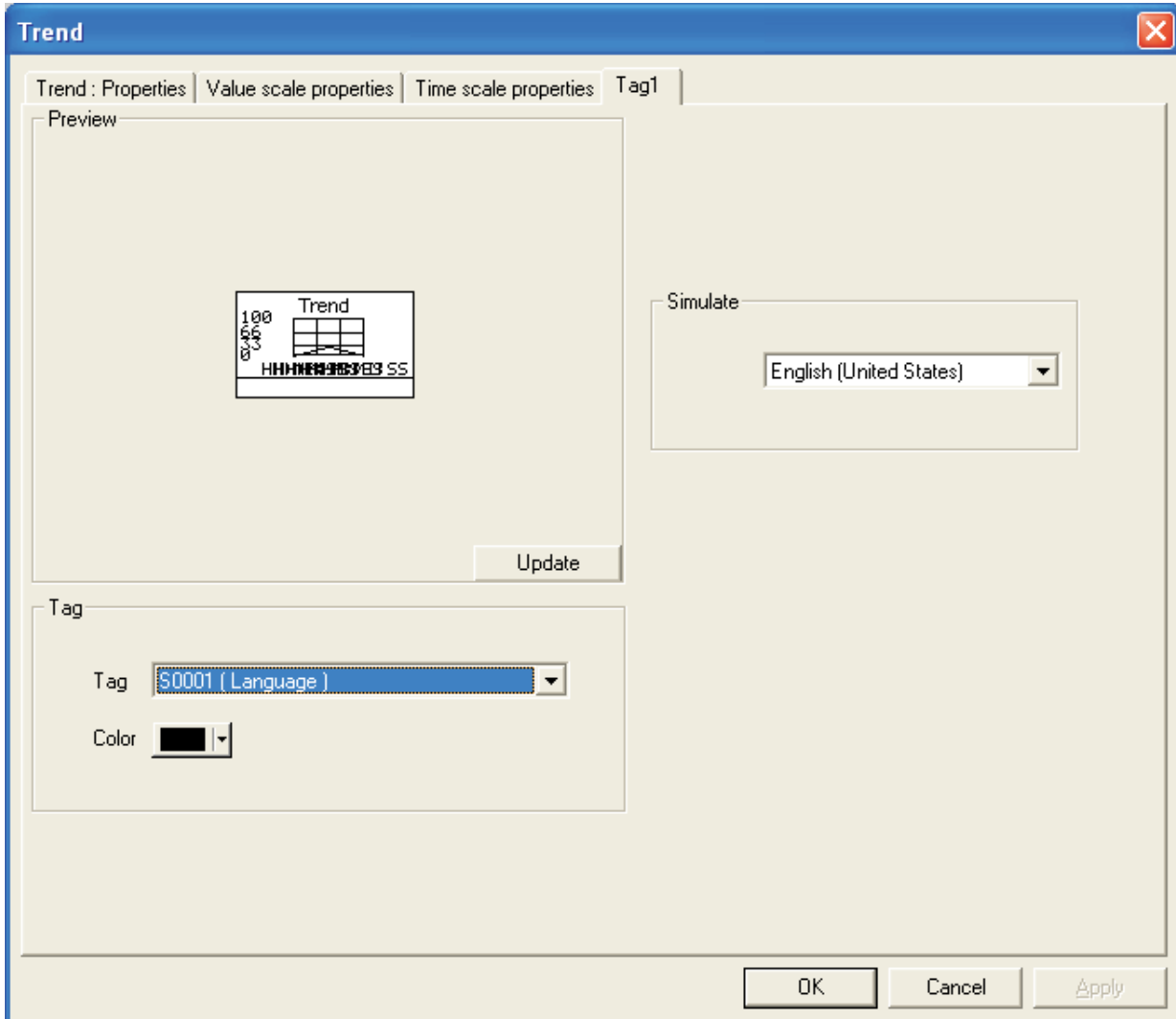

1. **Tag** : Defines a 2 byte tag to be used for the trend information to be plotted.
2. **Color** : Defines the color for the trend information to be plotted.

### 5.3.8 Numeric Keypad

A numeric keypad is required to enter data in a touch screen product. The user can select either a static or popup keypad. A static keypad is present on the same screen as the data entry objects. If a popup keypad is required, the designer needs to select the popup keypad option and the popup screen desired for the data entry.

If you select Static keypad, the **Display Area** check box is always disabled. But if you select Popup keypad, you have choice to enable or disable the Display area according to your application.

#### Key Pad Properties

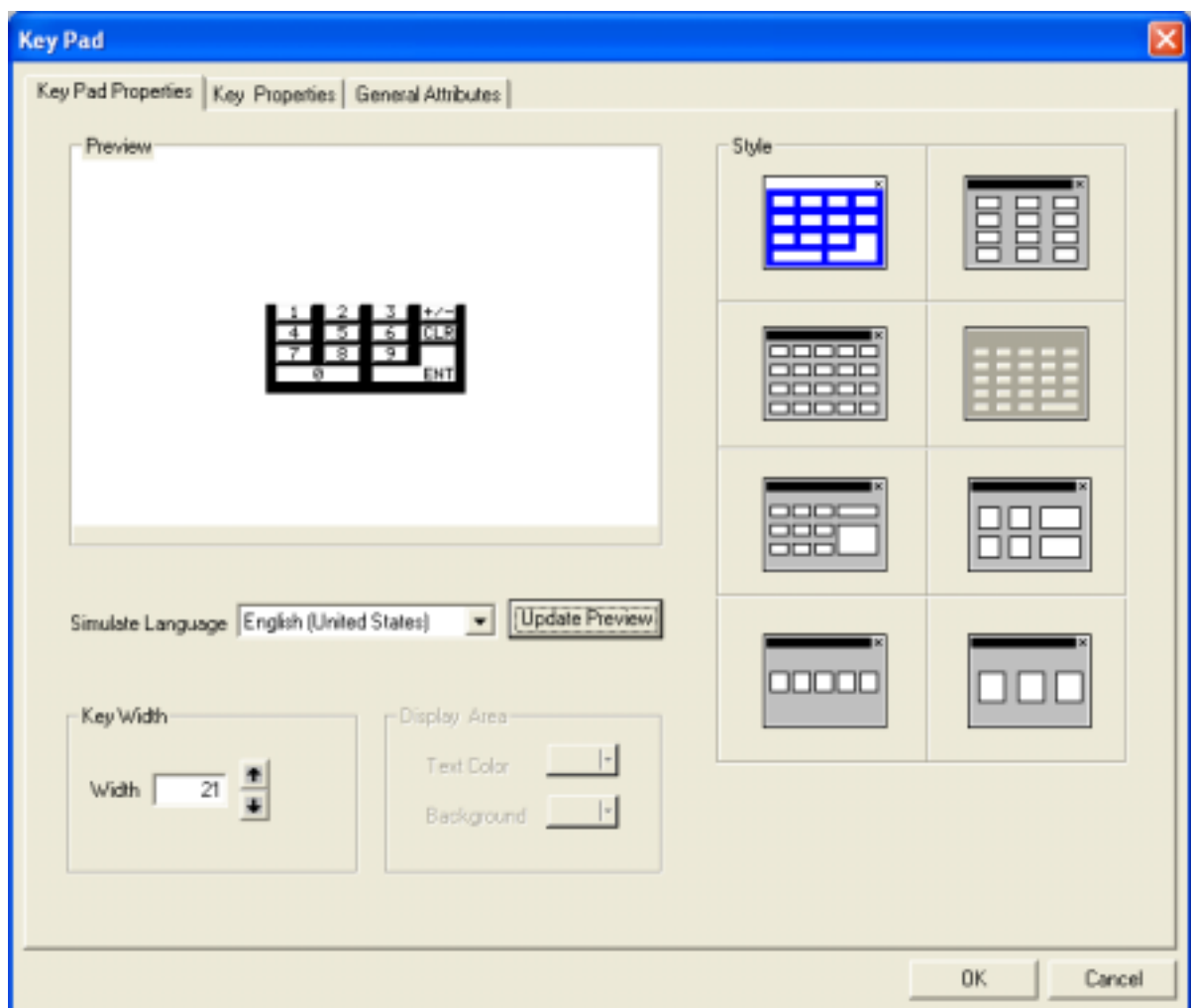

1. **Update Preview** : As changes are made, the user can preview the effect.
2. **Simulate Language** : Used to simulate the text of the languages configured for the object in the preview window.
3. **Style** : Used to select the keypad style from the list.
4. **Display Area** : This option is active only for popup keypads.
  - Text Color** : Select the color for the text displayed in value area.
  - Background** : Select the background color in the display area.

## Representing Data

---

### Key Properties

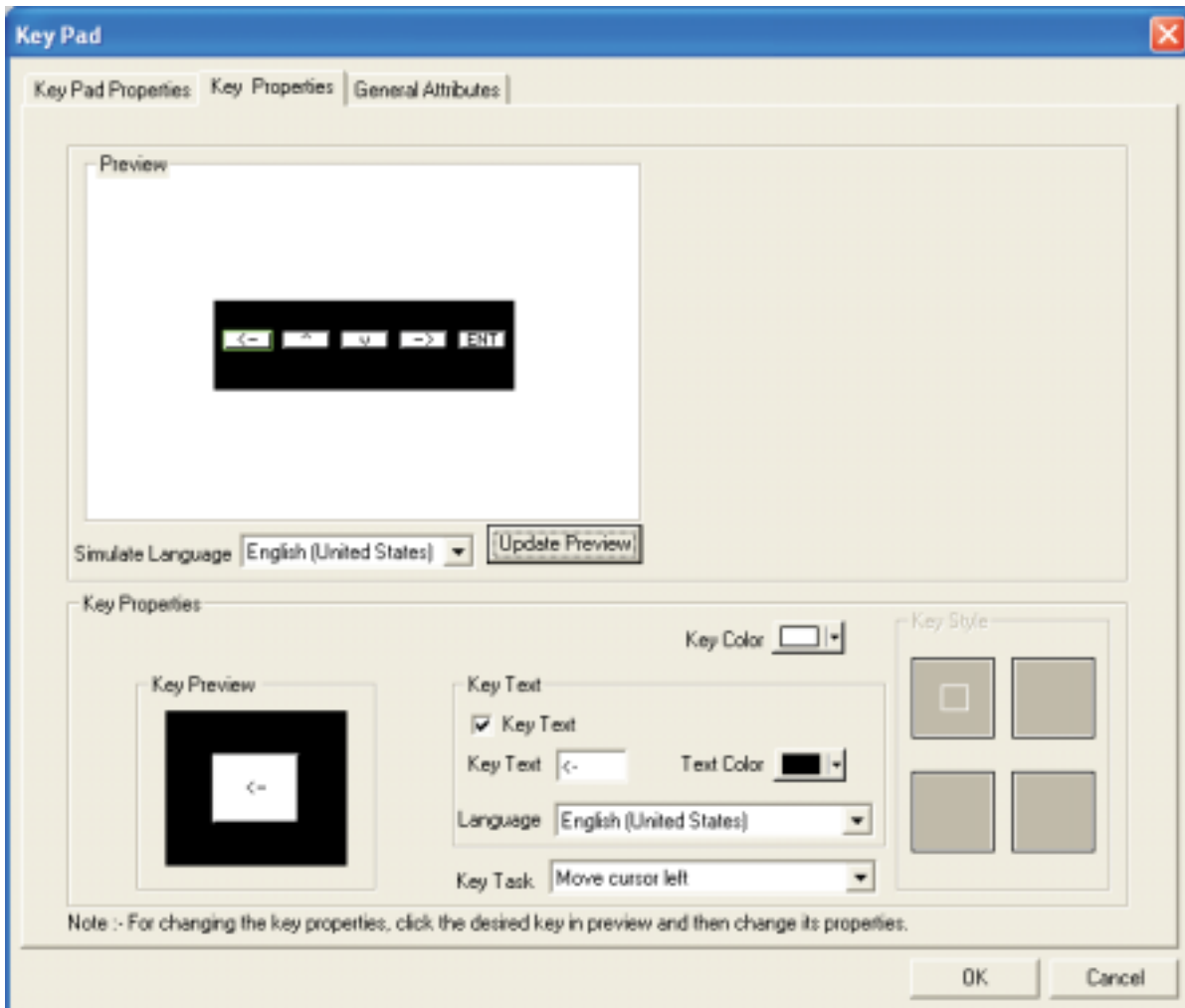

Key properties available to the user :

1. **Update preview** : User can check preview of defined keypad.
2. **Simulate** : Simulates the text of various languages configured in the object in the preview window.
3. **Key Color** : Selects the key color.
4. **Key Text check box** : Enables key text and language entry.
5. **Text Color** : Selects the key text color.
6. **Key Text** : Up to 3 characters can be used for the key text.
7. **Language** : Displays language depending upon number of languages configured in the application.
8. **Key task** : This determines the task to be performed by the key.

General Attributes

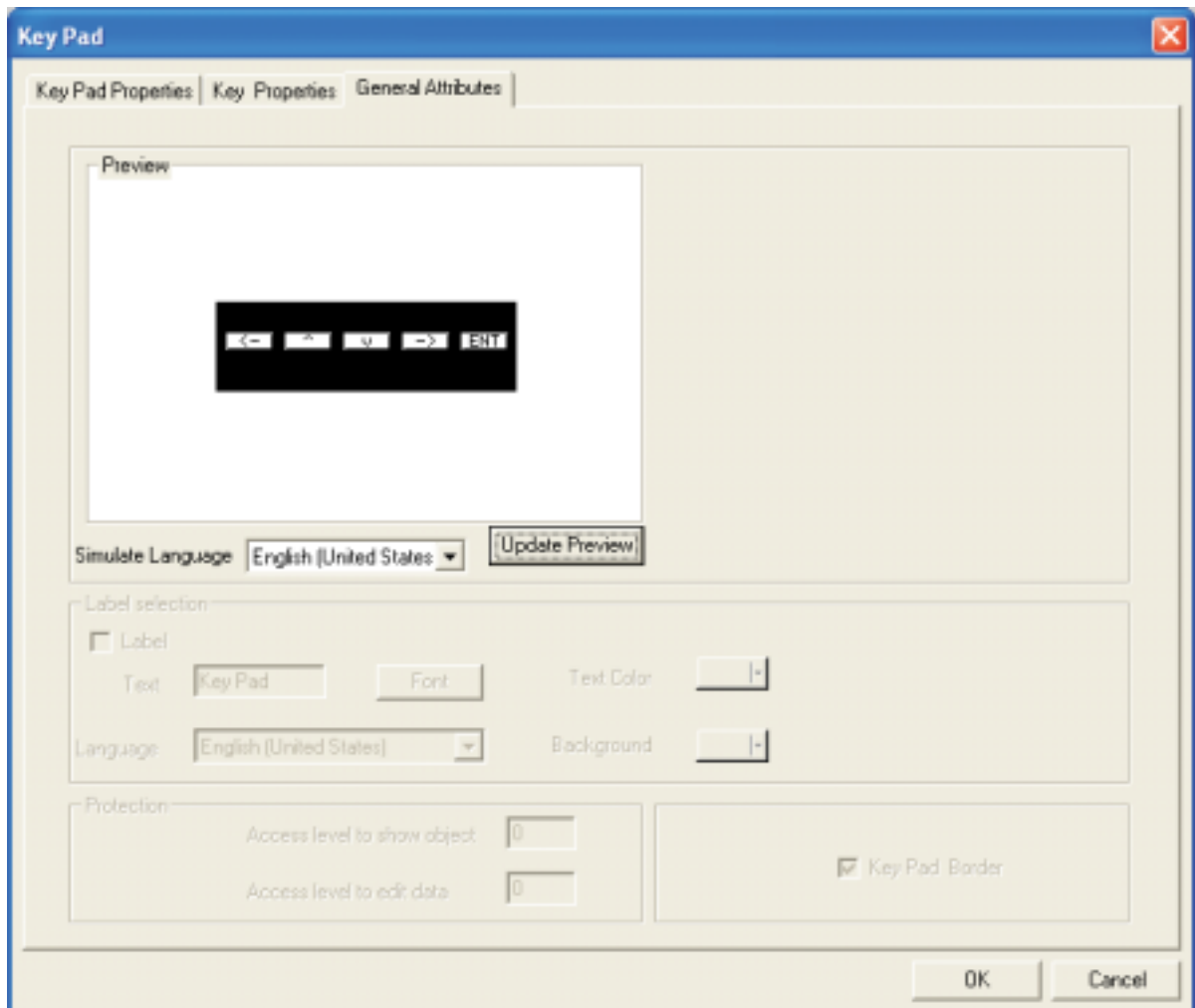

1. **Simulate** : Used for simulation of the text for each of the languages defined in the Unit Settings.
2. **Update Preview** : This allows the user to preview the design.

**Note:** Options that are not supported for this model are grayed out.

## Representing Data

---

### Key Properties

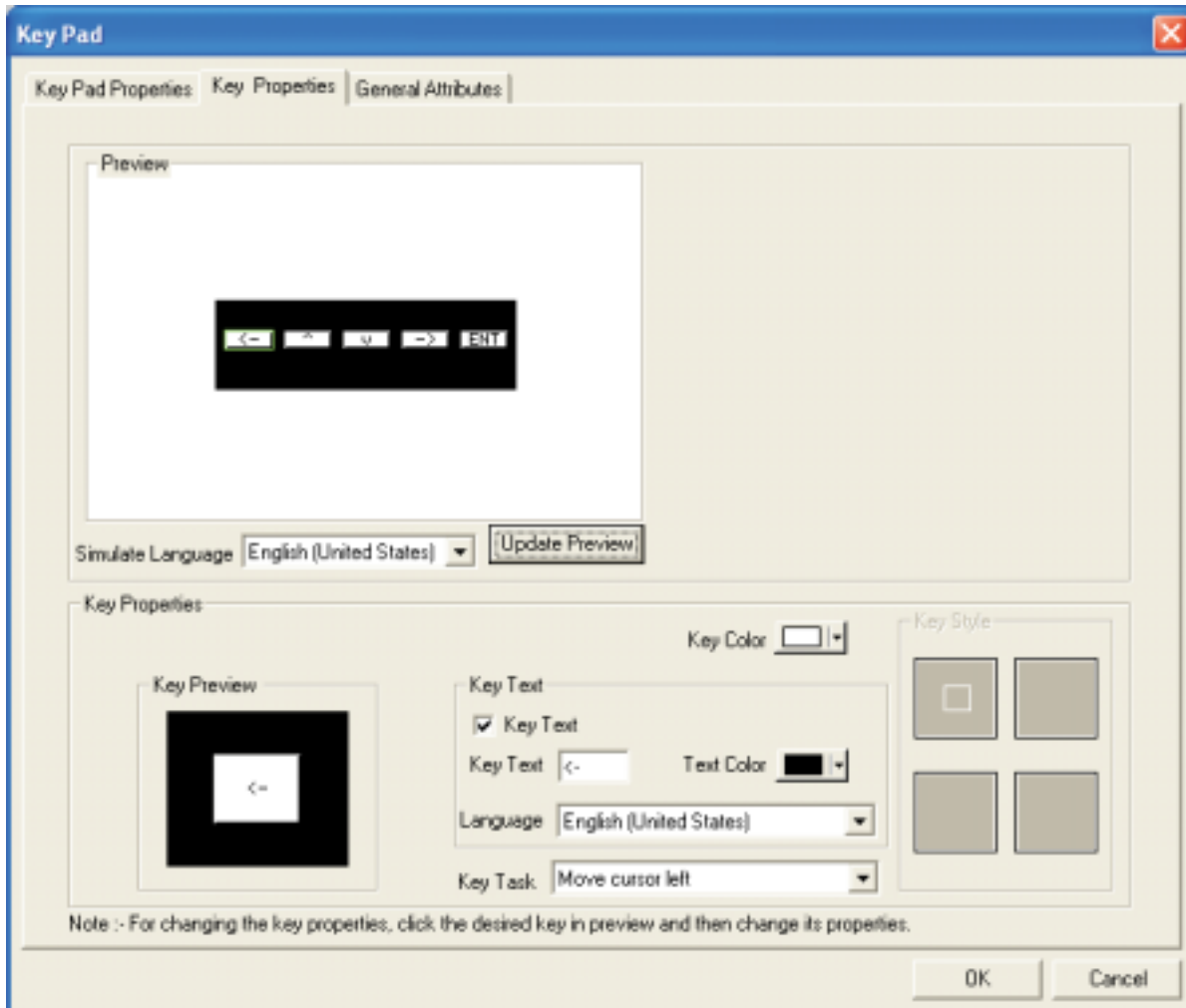

Key properties available to the user :

1. **Update preview** : User can check preview of defined keypad.
2. **Simulate** : Simulates the text of various languages configured in the object in the preview window.
3. **Key Color** : Selects the key color.
4. **Key Text check box** : Enables key text and language entry.
5. **Text Color** : Selects the key text color.
6. **Key Text** : Up to 3 characters can be used for the key text.
7. **Language** : Displays language depending upon number of languages configured in the application.
8. **Key task** : This determines the task to be performed by the key.



General Attributes

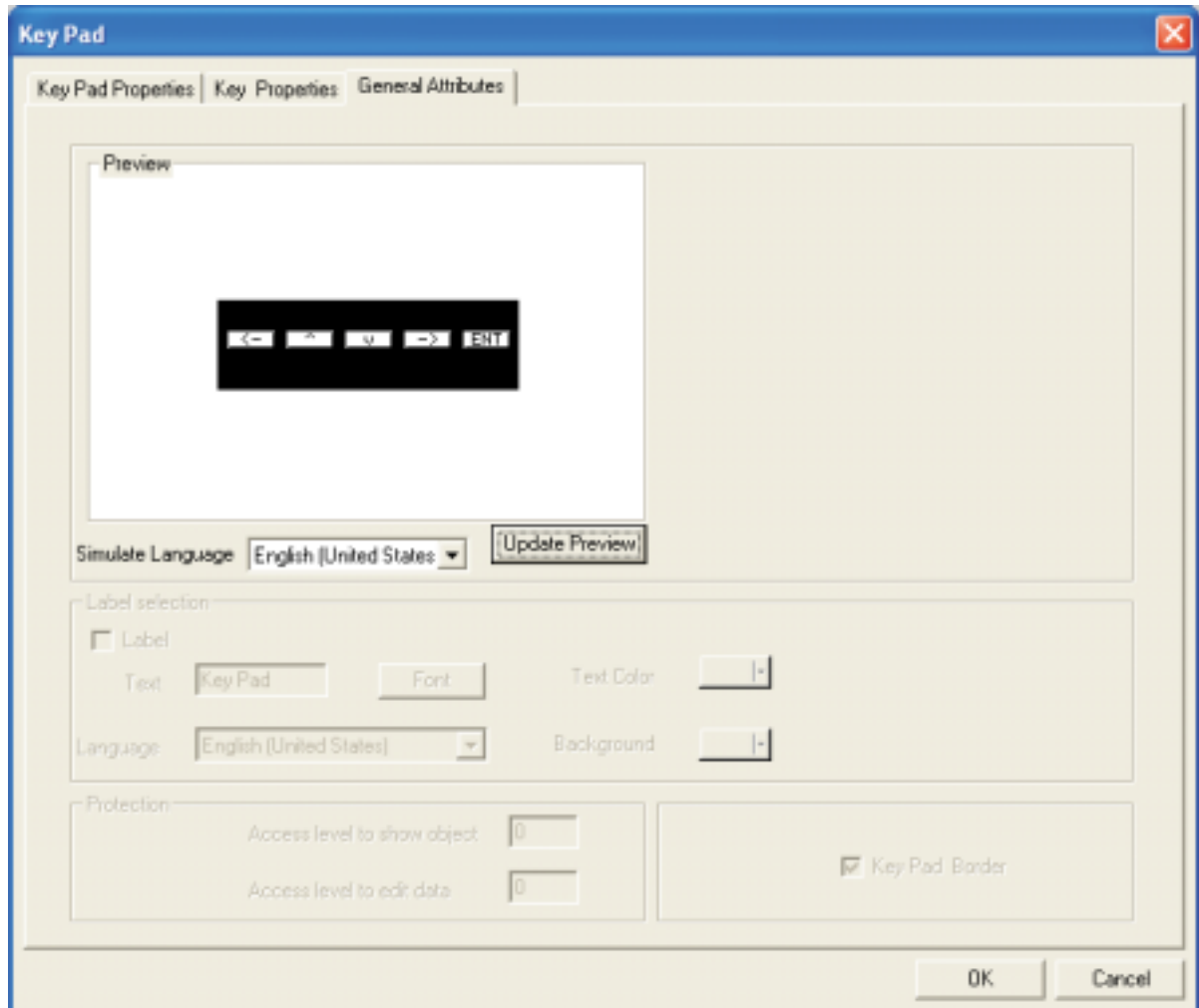

1. **Simulate** : Used for simulation of the text for each of the languages defined in the Unit Settings.
2. **Update Preview** : This allows the user to preview the design.

**Note:** Options that are not supported for this model are grayed out.

### TASK MANAGEMENT

In this chapter. . . .

- ◆ Application TaskList
- ◆ Screen TaskList
- ◆ Key TaskList

### Tasks

Task provides an interface between a unit and a PLC.

Using mathematical operations on unit tags or PLC's tags user can monitor the data. User can use these tasks in following events -

1. Application Tasklist
2. Screen Tasklist
3. Key Tasklist

#### 6.1 Application TaskList

Using this screen two types of tasklist can be defined.

- 1) Power On Tasks : These task execute only once when NTXS unit is powered on.
- 2) Global Tasks : Tasks from this task list execute globally i.e. always.

Using Up / Down buttons tasks can be shifted up or down. Using Delete button selected task can be removed from List of TaskList.

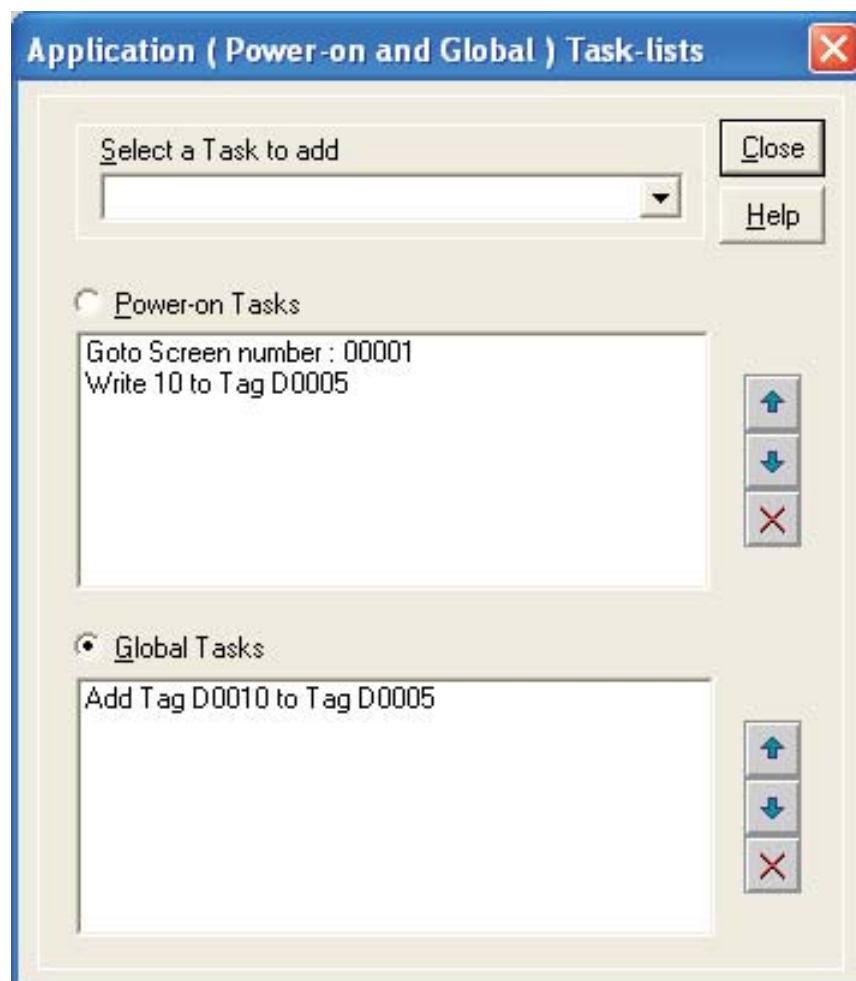





## Task Management

---

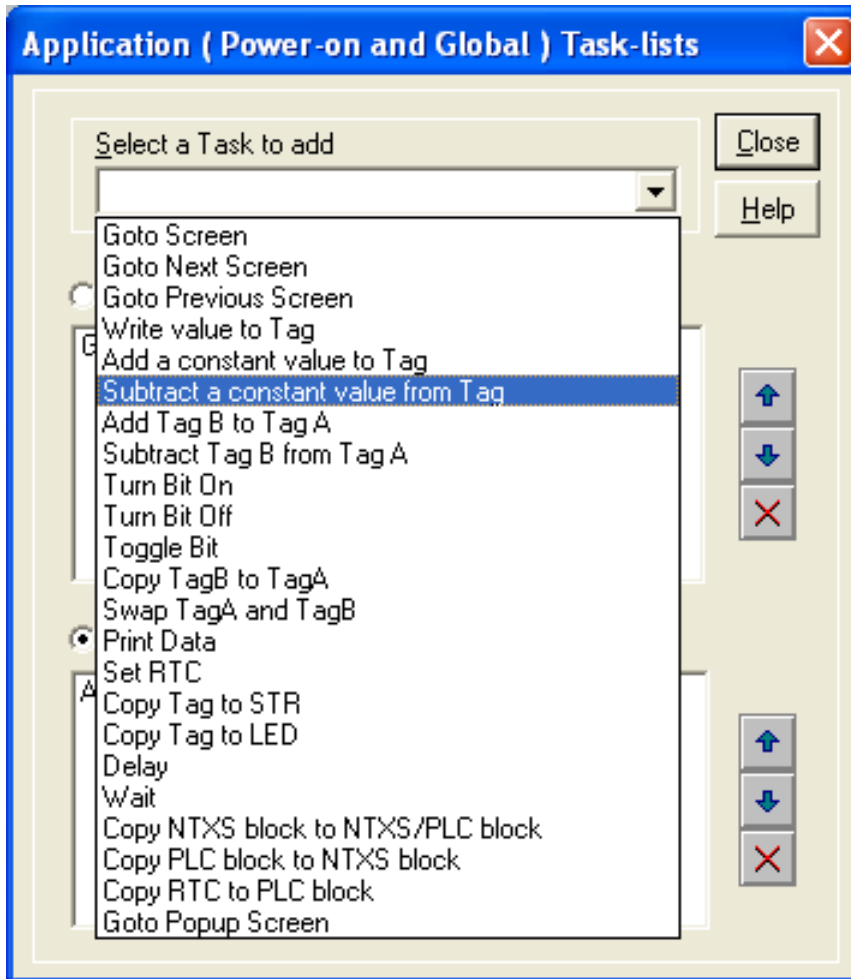
### Select a Task to add

User can select a Task from the list of Tasks available.



- Close**  - Accepts selected task.
- Up arrow**  - Selected task is shifted up.
- Down arrow**  - Selected task is shifted down.
- Delete**  - Selected task is deleted.

## 6.2 Screen TaskList

These tasks are related to a particular screen. When a screen is displayed, tasks defined for that screen are executed.

### 'Before showing' Tasks:

These tasks are executed once just before screen is displayed. So any screen specific initialization can be defined under this option.

### While showing Tasks:

These screen tasks are executed continuously as long as screen is displayed.

### After hiding Tasks:

These screen tasks are executed once just after screen is hidden.

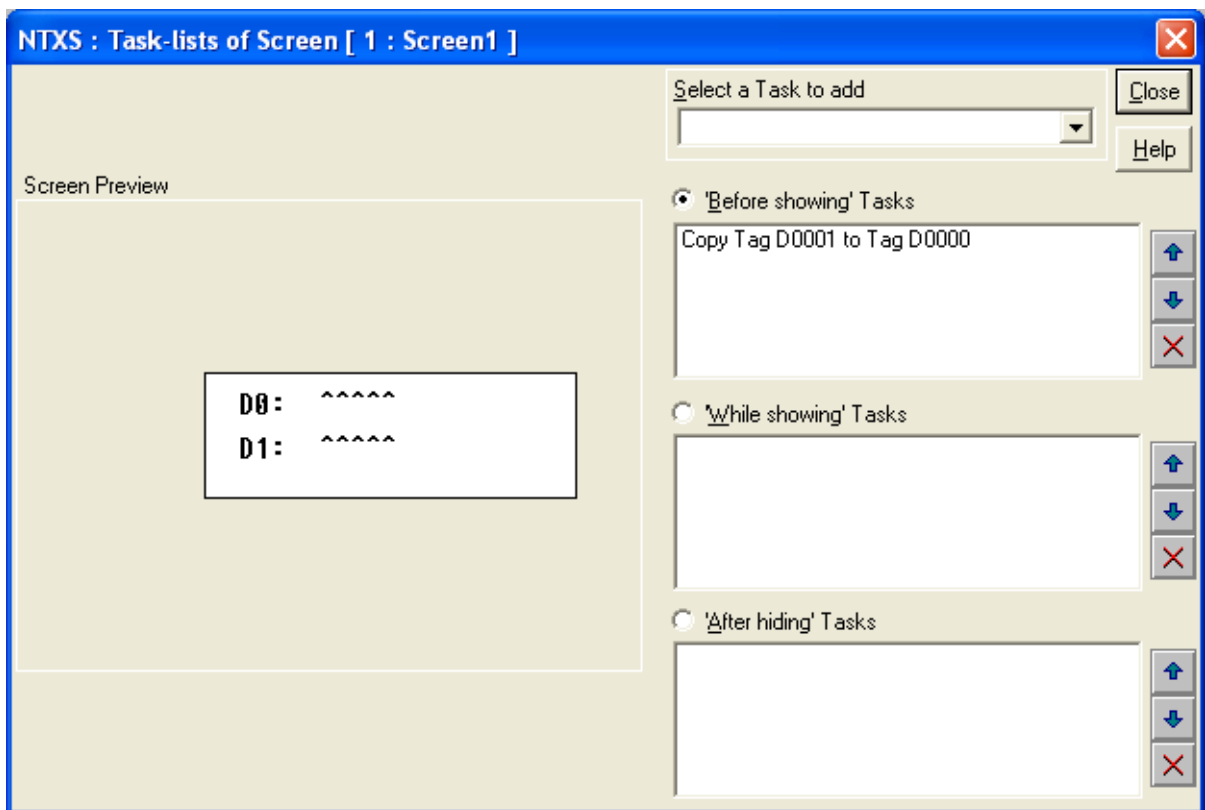





## Task Management

---

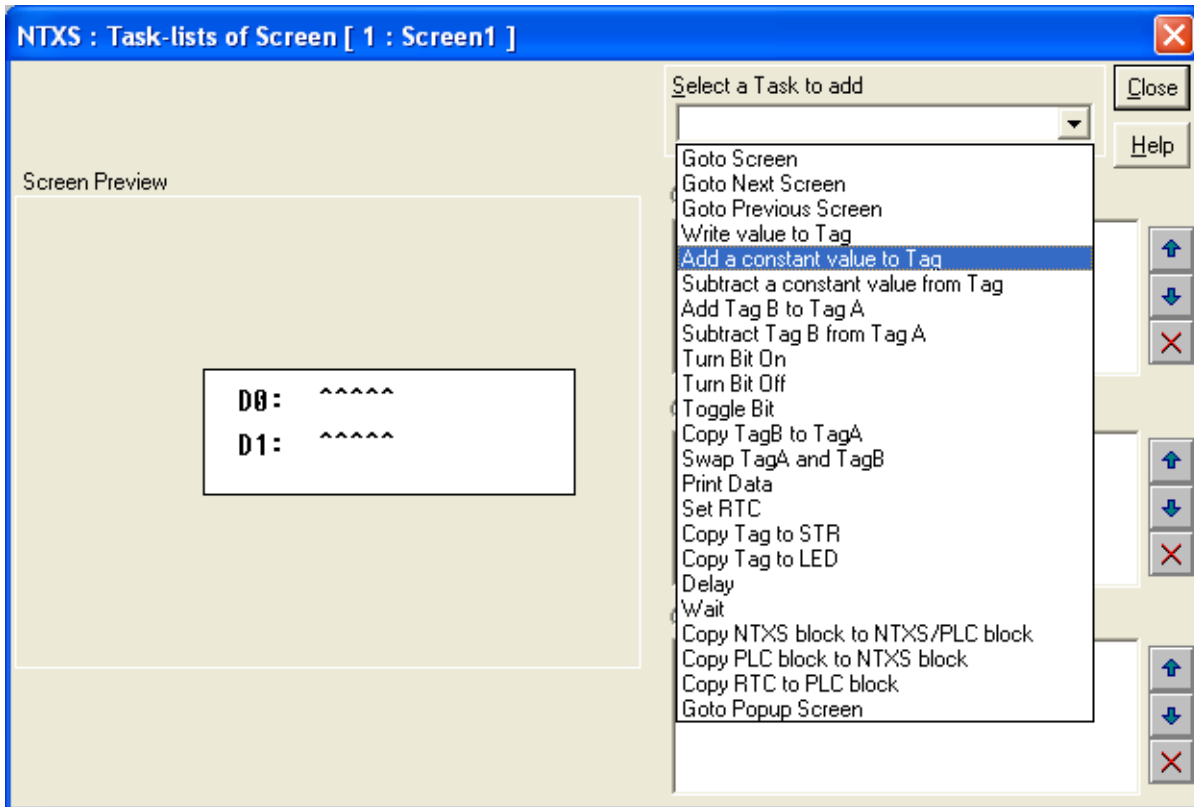
### Select a Task to add

User can select a Task from the list of Tasks available.



- |   |                                  |
|---|----------------------------------|
| <b>Close</b>       | - Accepts selected task.         |
| <b>Up arrow</b>    | - Selected task is shifted up.   |
| <b>Down arrow</b>  | - Selected task is shifted down. |
| <b>Delete</b>      | - Selected task is deleted.      |

### 6.3 Key Tasklist





User can define task on key events like -

- Press Tasks** – These tasks are performed only once when the key is pressed.
- Pressed Tasks** – These tasks are performed as long as the key is pressed.
- Released Tasks** – These tasks are performed when the key is released.

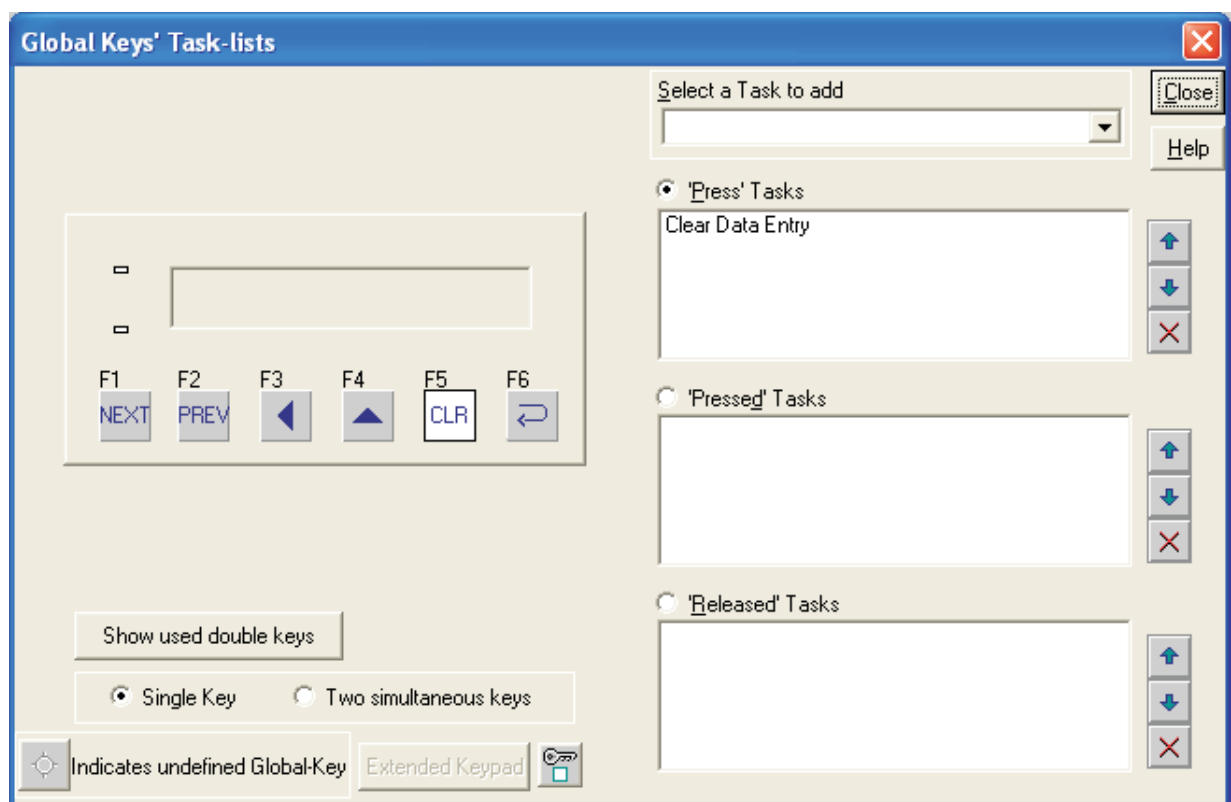
#### 6.3.1 For Keypad Products

**1. Global Keys Tasklist** - Tasks defined under this option are executed for whole application, independent of screens.





- Close**  - Accepts selected task.
- Up arrow**  - Selected task is shifted up.
- Down arrow**  - Selected task is shifted down.
- Delete**  - Selected task is deleted.
- Show used double keys** - Shows the list of combination keys used to define the tasks.
- Single Key** - If this option is selected, a task is defined to one key.
- Two simultaneous keys** - If this option is selected, a task is defined to a combination of two keys.

## Task Management

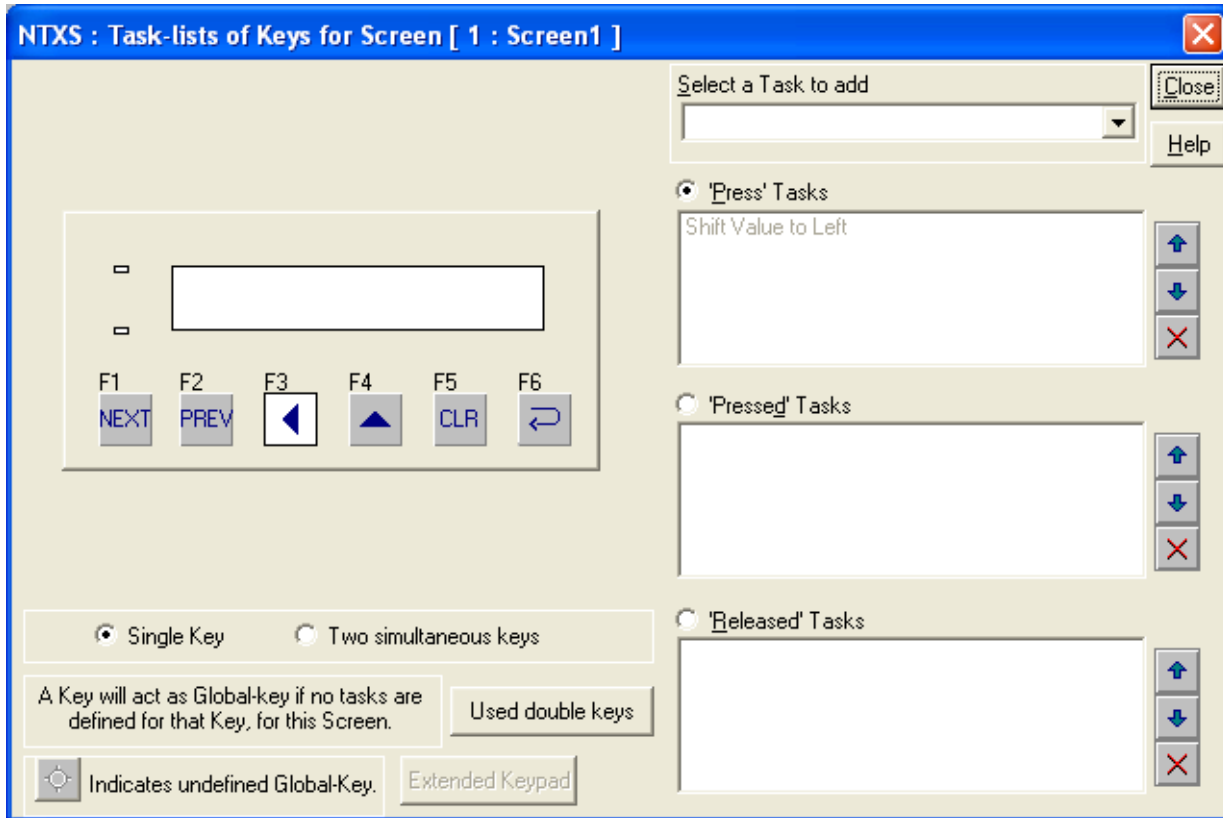
**2. Screen Keys' Tasklist** - Task defined under this option are executed only for currently displayed screen . These are screen dependent tasks.



- Close** - Accepts selected task.
- Up arrow**  - Selected task is shifted up.
- Down arrow**  - Selected task is shifted down.
- Delete**  - Selected task is deleted.
- Used double keys** - Shows the list of combination keys used to define the tasks.
- Single Key** - If this option is selected, a task is defined to one key.
- Two simultaneous keys** - If this option is selected, a task is defined to a combination of two keys.





**Note:** Screen Keys' Tasklist has higher priority over Global Keys' Tasklist when the screen is displayed.



### 6.3.2 For Touch screen Products

#### Touch-Screen Tasklist

To use this task we need a Button object (Bit Button or Word Button) on the screen. When the user touches within the Button area, the associated task is executed.

- Close  - Accepts selected task.
- Up arrow  - Selected task is shifted up.
- Down arrow  - Selected task is shifted down.
- Delete  - Selected task is deleted.

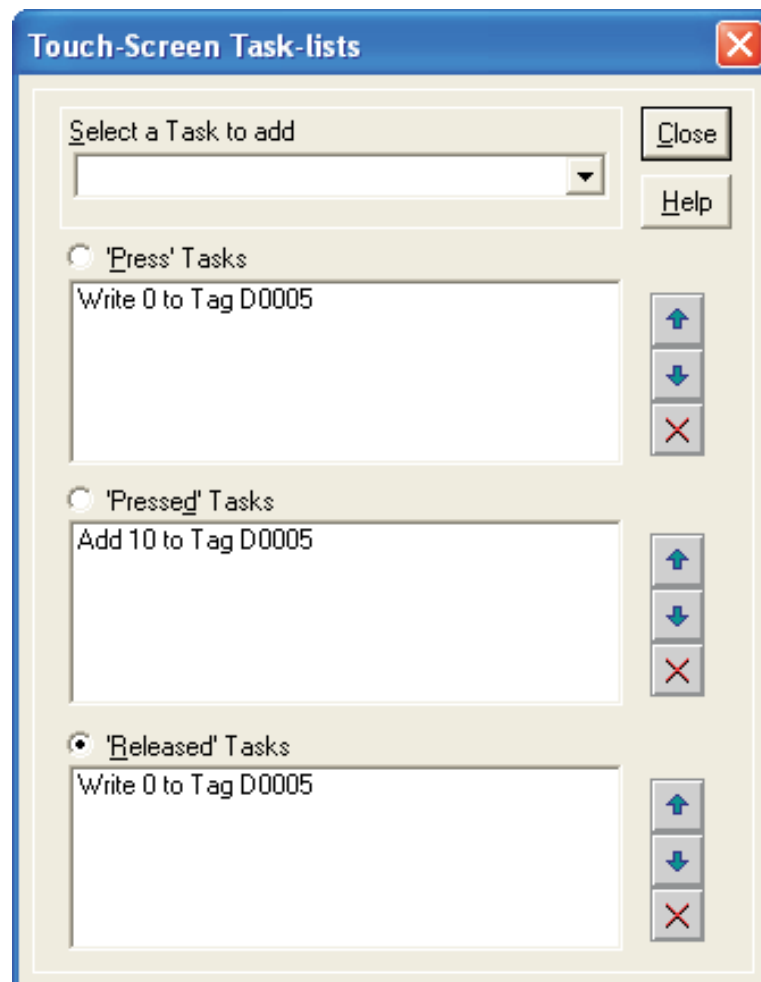

## Task Management

---

### 6.4 Description of Tasks

#### ● Go To Screen

This task is used to jump to any available screen from list of available screens.

When we add Goto Screen task in the task list, a dialog box is displayed. It shows list of screens defined in the application.

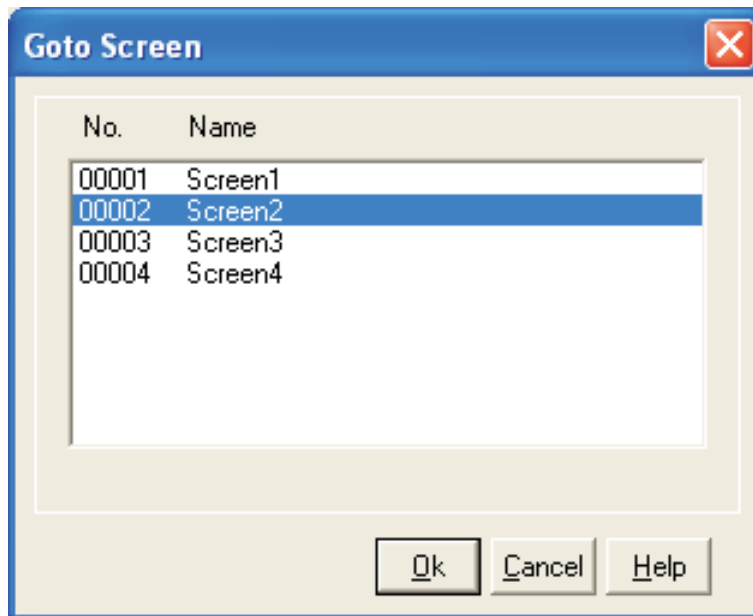

To add this task, select a screen from the list and press 'Ok'. When this task is executed, control jumps to the selected screen.

#### ● Goto Next Screen

When this task is executed, control jumps to next available screen. If user defines this task on the last screen, then after execution of this task "Screen not defined " message appears for 2 seconds and control comes back to last screen displayed.

#### ● Goto Previous Screen

When this task is executed, control jumps to previous available screen. If user defines this task on the first screen, then after execution of this task "Screen not defined " message appears for 2 seconds and control comes back to last screen displayed.

● **Write Value To Tag**

A constant value can be written to a tag using this task, provided the tag is not a read-only tag.

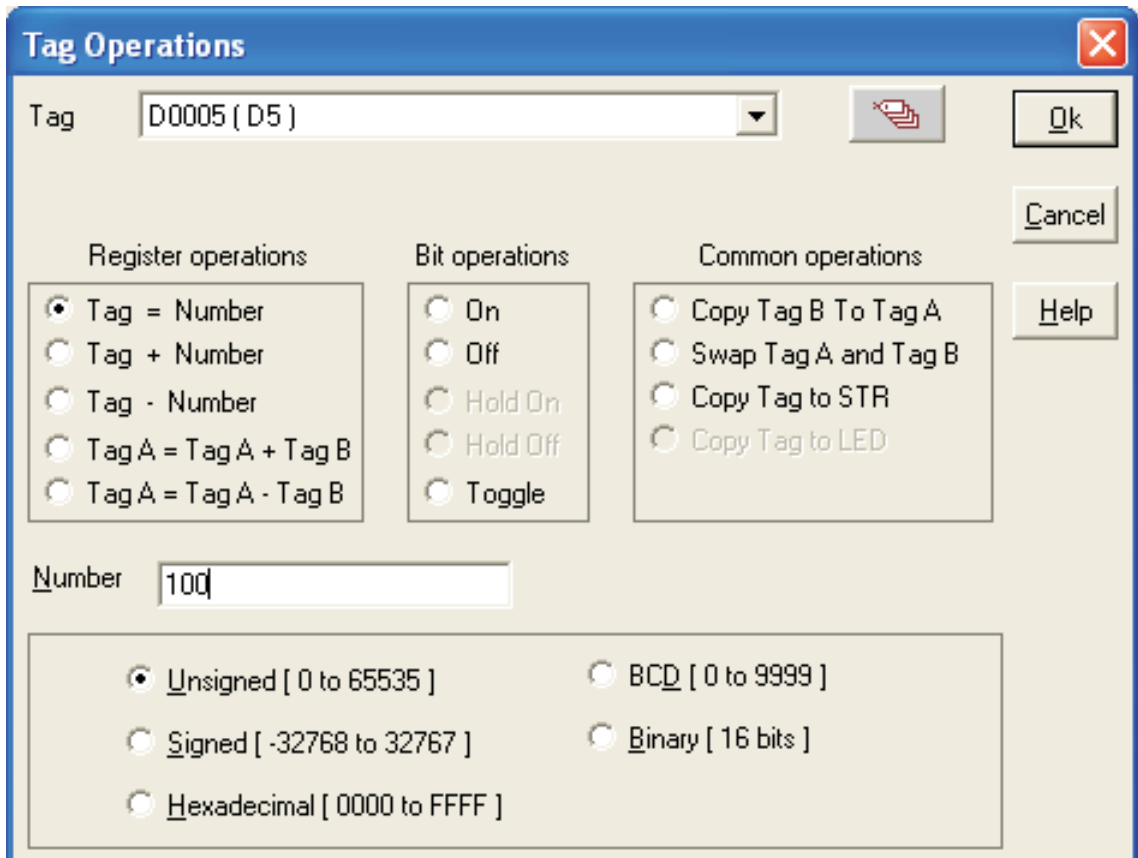

E.g.- Tag = Number

This task is executed on register tag listed under Tag option. User can write only two bytes number in selected tag .

If tag is defined as 1 byte - Low-byte transfer to low-byte.

2 byte – Low and High-bytes transfers respective bytes of tag.

4 byte – Only Low-word transfer to tag.

For this task default setting is shown under 'Register operations'. If user change this selection, task will be changed.

User can select number type - unsigned int , Signed, Hexadecimal, BCD and Binary.

User can select number type - unsigned int , Signed, Hexadecimal, BCD and Binary.

Click 'OK' to add task in task list.

## Task Management

### ● Add a Constant Value To Tag

This tag is used for adding a constant value to the current value of the tag.

The screenshot shows the 'Tag Operations' dialog box with the following settings:

- Tag:** D0005 ( d5 )
- Register operations:**
  - Tag = Number
  - Tag + Number
  - Tag - Number
  - Tag A = Tag A + Tag B
  - Tag A = Tag A - Tag B
- Bit operations:**
  - On
  - Off
  - Hold On
  - Hold Off
  - Toggle
- Common operations:**
  - Copy Tag B To Tag A
  - Swap Tag A and Tag B
  - Copy Tag to STR
  - Copy Tag to LED
- Number:** 50
- Number type:**
  - Unsigned [ 0 to 65535 ]
  - Signed [ -32768 to 32767 ]
  - Hexadecimal [ 0000 to FFFF ]
  - BCD [ 0 to 9999 ]
  - Binary [ 16 bits ]

E.g.- Tag = Tag + Number

This task is executed on register tag listed under Tag option. User can add only two byte number in selected tag.

Tag Type	Operation	Number	Result
1 Byte	+	2 Byte	1 Byte
2 Byte	+	2 Byte	2 Byte
4 Byte	+	2 Byte	Lower 2 Byte

For this task default setting is shown under 'Register operations'. If user change this selection, task will be changed. User can select number type - unsigned int, Signed, Hexadecimal, BCD and Binary. Click 'OK' to add task in task list.

● **Subtract a Constant Value From Tag**

This task is used to subtract a constant value from the current value of a tag.

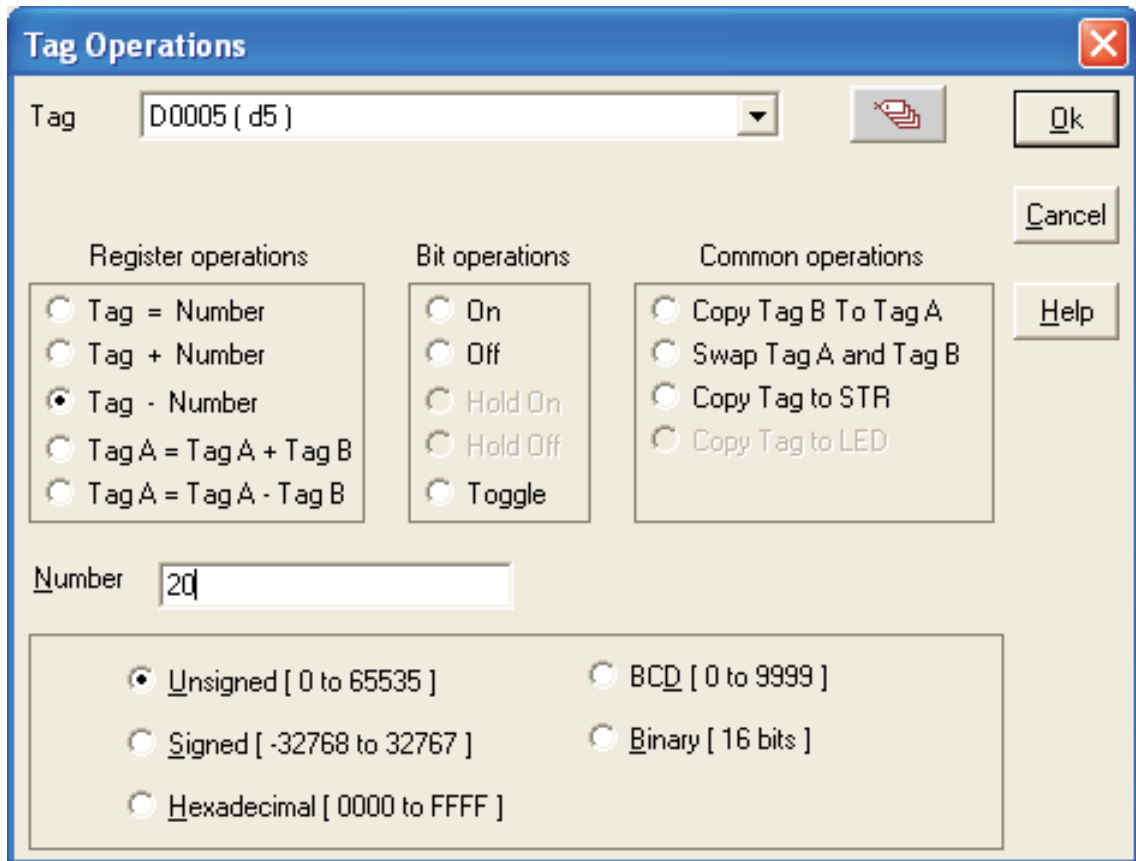

E.g.- Tag = Tag - Number

This task is executed on register tag listed under Tag option. User can subtract only two byte number in selected tag.

Tag Type	Operation	Number	Result
1 Byte	-	2 Byte	1 Byte
2 Byte	-	2 Byte	2 Byte
4 Byte	-	2 Byte	Lower 2 Byte

For this task default setting is shown under 'Register operations'. If user change this selection, task will be changed.

User can select number type - unsigned int, Signed, Hexadecimal, BCD and Binary.

Click 'OK' to add task in task list.

## Task Management

---

### ● Add Tag B To Tag A

This tag is used for addition of two PLC Tags . The result will be stored in tag A.

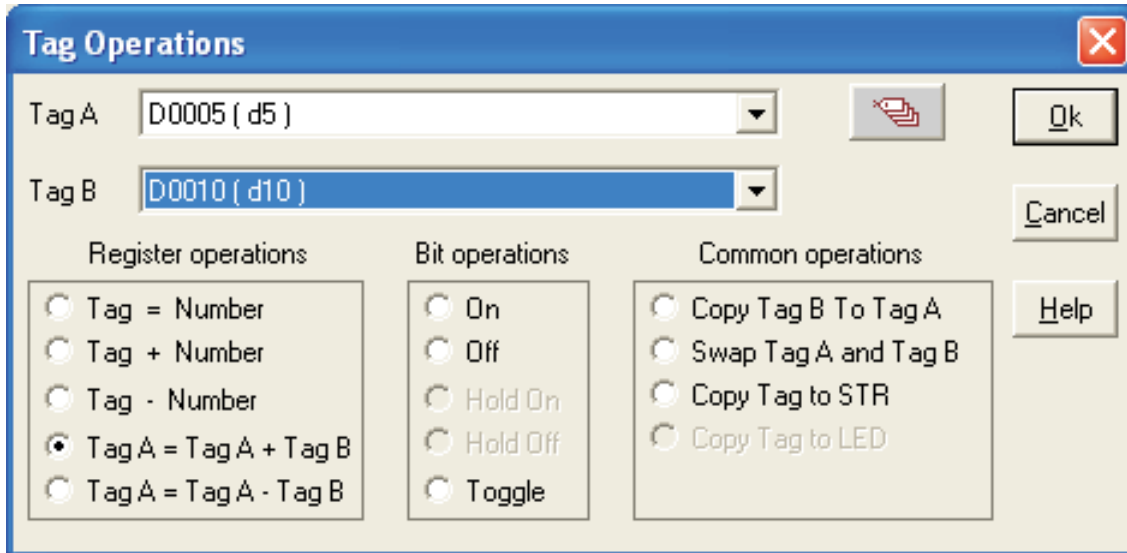

E.g.-  $\text{TagA} = \text{TagA} + \text{TagB}$

This task is applicable for register type tags only.

For successful operation both tag must be of same attributes like data type ( unsigned int, signed int, Hex etc.) and size ( 1 byte,2 byte, 4 byte etc)

### ● Subtract Tag B from Tag A

This task is used for subtracting two PLC tags. The result will be stored in tag A.

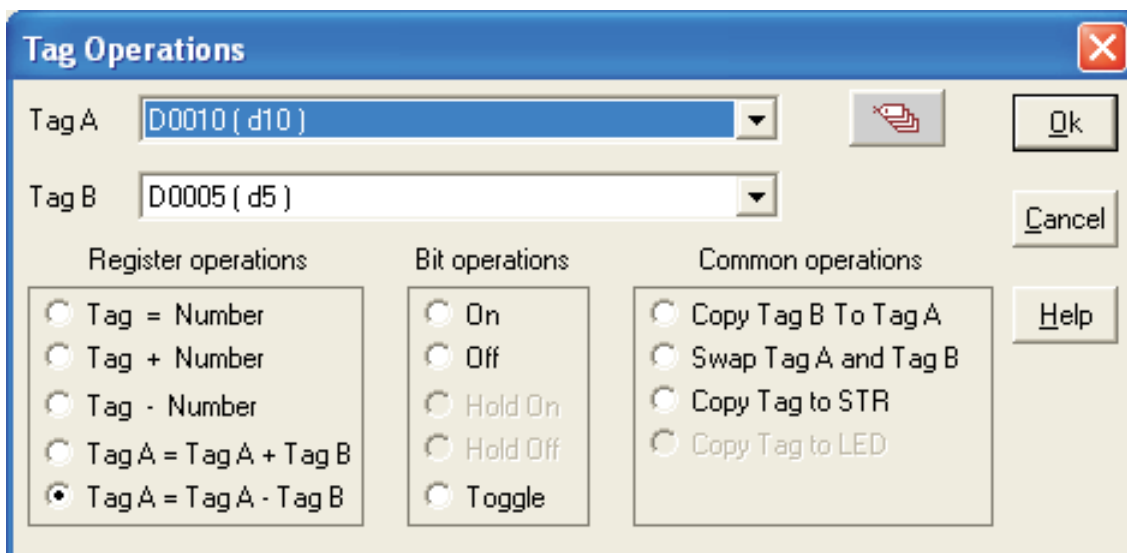

E.g.-  $\text{TagA} = \text{TagA} - \text{TagB}$

This task is executed with selected register type tags only.

For successful operation both tag must be of same data type (unsigned int, signed int, Hex etc.) and size ( 1 byte,2 byte, 4 byte etc)

● **Turn bit On**

This task is used for switching PLC coil or register bit to on state. The bit/coil should be a read-write coil.

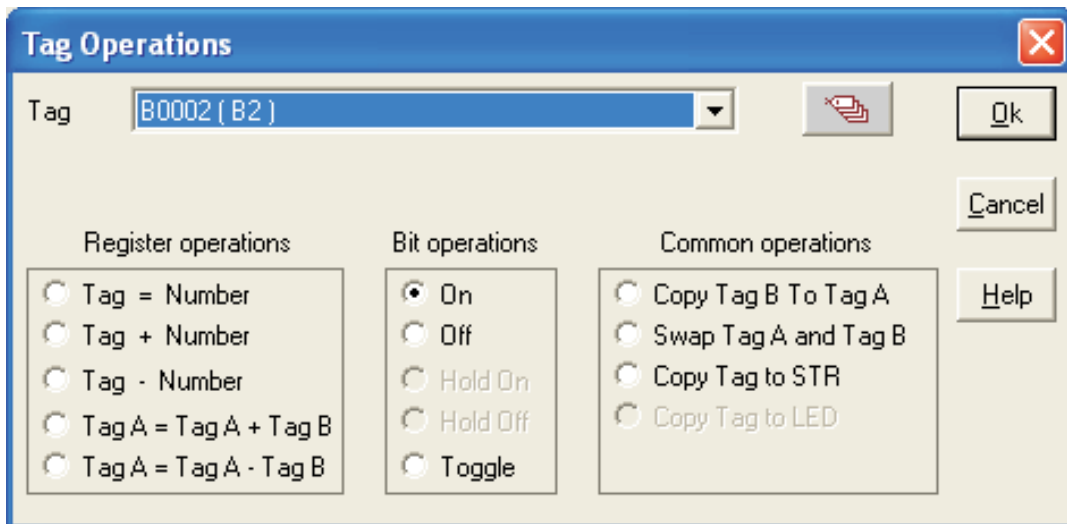

This task is executed on coil or bit-addressed register only. User can select coil or bit-addressed register from tag list.

By using this task user can set bit/coil to 1.

For this task default setting is shown under 'Bit operations'. If user change this selection, task will be changed.

Click 'OK' to add task in task list.

● **Turn bit Off**

This task is used for switching PLC coil or register bit to off state. The bit/coil should be a read-write coil.

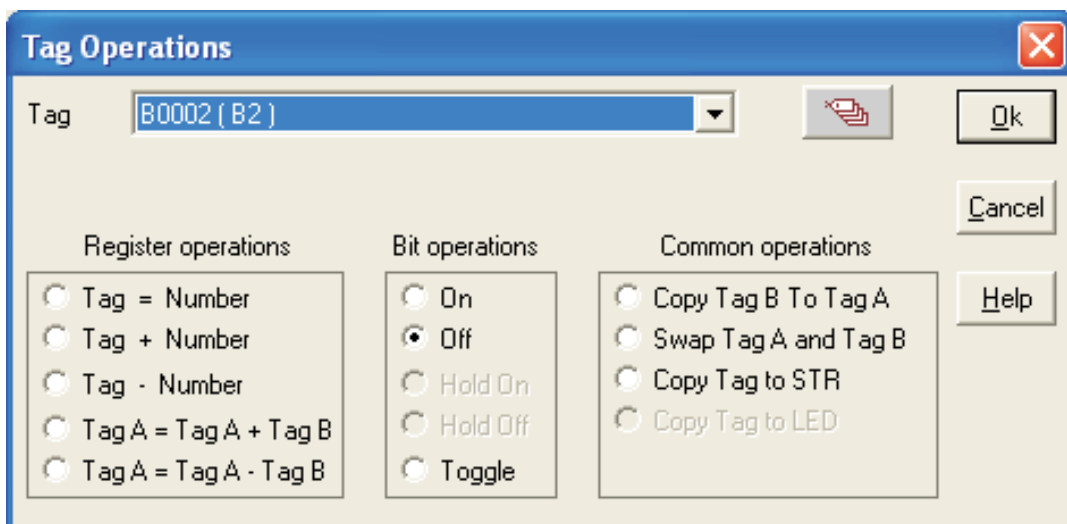

This task is executed on coil or bit-addressed register only. User can select coil or bit-addressed register from tag list. By using this task user can set bit/coil to 0.

For this task default setting is shown under 'Bit operations'. If user change this selection, task will be changed. Click 'OK' to add task in task list.

## Task Management

---

### ● Toggle bit

This task is used for toggling state of PLC coil or register bit. The bit/coil should be a read-write coil.

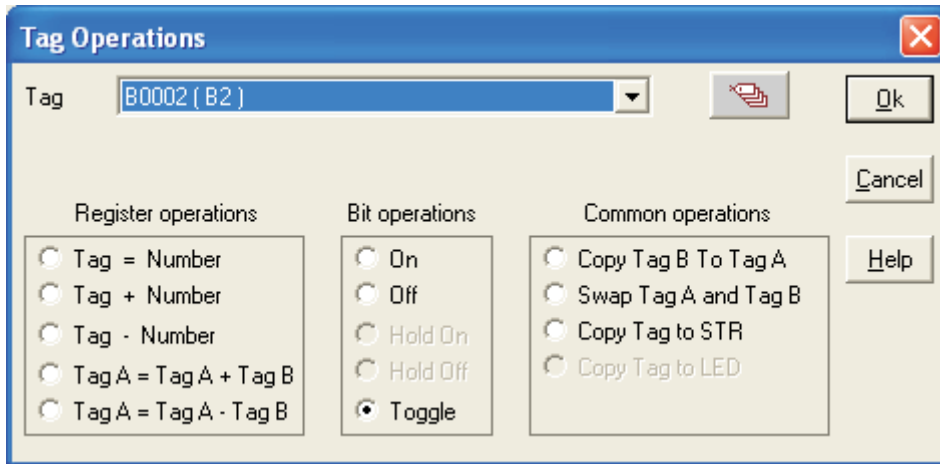

This task is executed on coil or bit-addressed register only. User can select coil or bit-addressed register from tag list.

When this task is executed, the bit/coil is set to 1 if it was 0 previously and vice-versa.

For this task default setting is shown under 'Bit operations'. If user change this selection, task will be changed.

Click 'OK' to add task in task list.

### ● Copy Tag B to Tag A

This task is used for copying value of one PLC tag to Other PLC tag. The value of tag B will be unchanged. Tag A will be same as tag B.

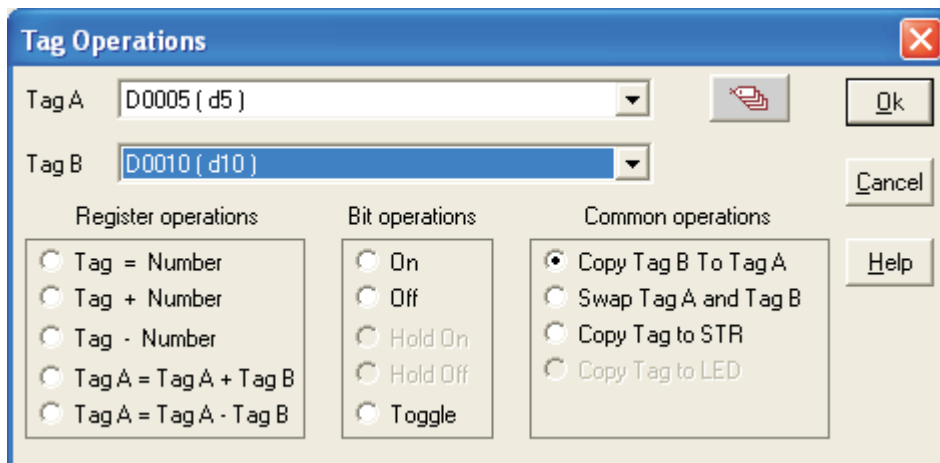

E.g.- Tag A = Tag B

This task is executed on register tags and coil or bit-addressed register listed under Tag option. Both tag type must be of same type; either register type or coil/bit type. If the selected tags are of register type than this command is executed depending on the tag length (i.e. 1 byte, 2 byte, 4 byte ).

For this task default setting is shown under 'Common operations'. If user change this selection, task will be changed. Click 'OK' to add task in task list.



● **Swap Tag A and Tag B**

This task is used for swapping the values of two PLC tags. Tag A value will be copied to tag B and tag B value will be copied to tag A.

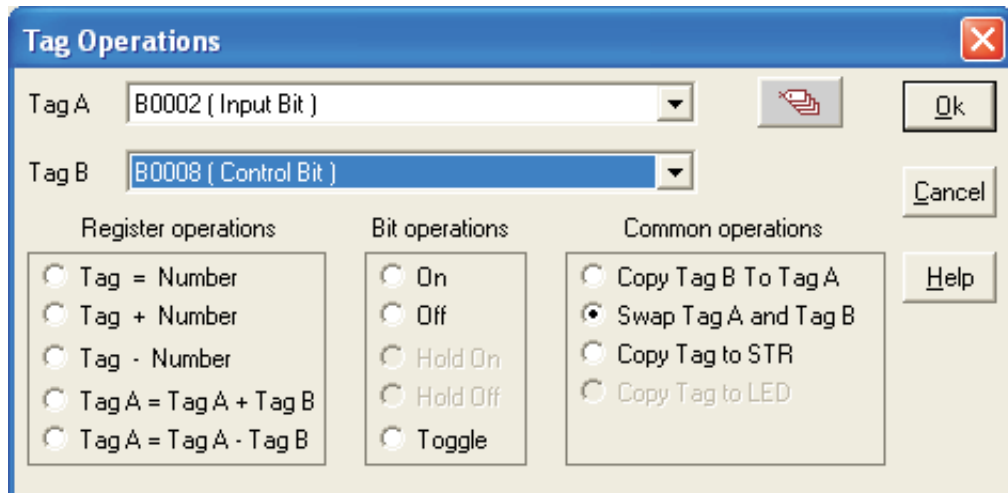

This task is executed on register tags and coil or bit-addressed register listed under Tag option. Both tag type must be of same type; either register type or coil/bit type. If the selected tags are of register type than this command is executed depending on the tag length (i.e. 1 byte,2 byte, 4 byte ). User can interchange values of Tag A and Tag B by using this command.

For this task default setting is shown under 'Common operations'. If user change this selection, task will be changed.

Click 'OK' to add task in task list.

● **Copy Tag to STR**

This is a very important task which allows user to copy the value of selected PLC to Tag STR i.e.Screen Trigger register. Screen Trigger Register is a system register inside NTXS which decides the screen to be displayed. PLC tag can be copied to STR.

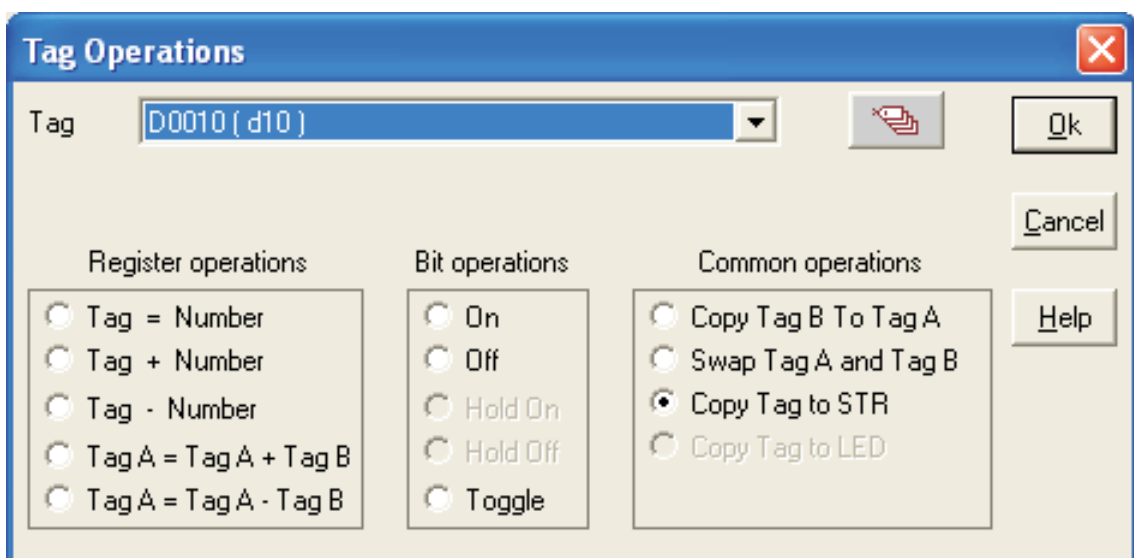

## Task Management

---

E.g.- STR (Screen Triggering Register) = Tag A

This task is executed on register tags listed under Tag option. Two byte tag value are transferred to STR. This task is used to jump to the screen number specified by value of STR.

For this task default setting is shown under 'Common operations'. If user change this selection, task will be changed.

Click 'OK' to add task in task list.

### ● Copy tag to LED

LED's on the keypad of NTXS can be turned on/off depending on the value of a tag. The tag should be copied to LED register and the LEDs will display the tag value.

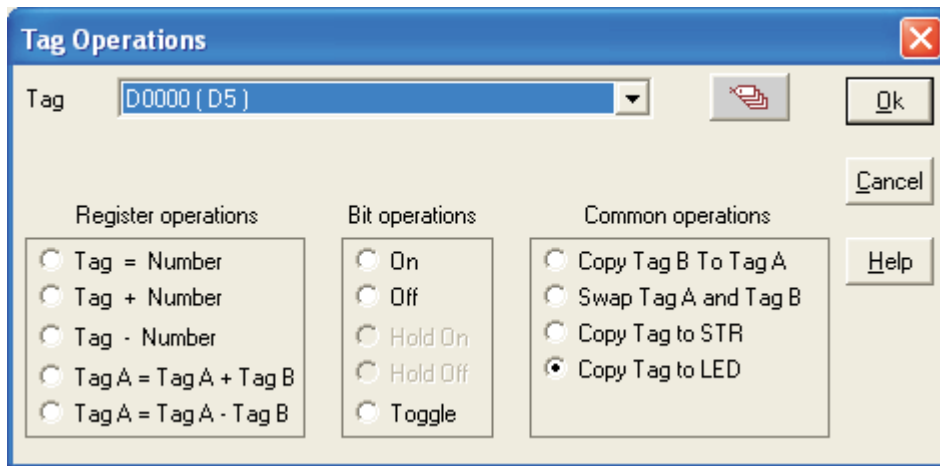

E.g.- LED = Tag A

LED is a internal unit register mapped to LED's displayed on unit. This task is executed on register tags listed under Tag option. Two byte tag value are transferred to LED register.

**Note:** This task is supported only for the units having LEDs on it.

For this task default setting is shown under 'Common operations'. If user change this selection, task will be changed.

Click 'OK' to add task in task list.

### ● Delay

Any task can be delayed using this task. Tags will be updated during this delay. After the delay is completed the next task will be performed.

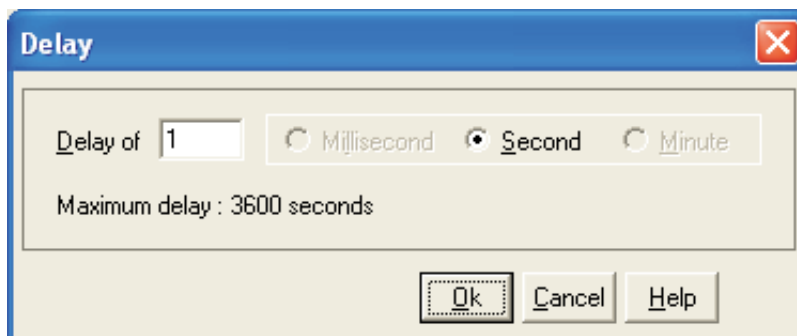

This task is supported for screen 'While showing' only . User can specify delay from 1 sec to max 3600 sec.

**Note:** More than 1 delay task is not supported.

### ● Wait

This is a conditional delay. Next task will not be performed till the specified condition is false. Execution remains in wait state till wait condition is true. Task following wait task is executed only after wait condition is false; Operand could be either number between 0 to 65535 or PLC tag.

This task is supported only in 'While showing' Tasks of the Screen Tasklist . Tasks defined after this task are not executed until the condition specified is true.

Here Tag is compared with the Operand. Operand can be a Number (0-65535) or Tag. Operation can be =, !=, <, <=, >, >=.

If Tag to be compared is bit/coil type then it is compared with On/Off state.

Click 'OK' to add task in task list.

### ● Set RTC

User can edit RTC (Real Time Clock) registers of the NTXS unit. This task increments selected RTC register at a time for one instance. User edit Year / Month / Date / Hour / Minutes / Seconds / Day of the week. User must place a Time / Date object on the screen for editing the RTC. This task is supported in key tasks only.

## Task Management

---

By using this task, user can set time and date for Real Time Clock (RTC). This can be done by incrementing or decrementing Year, Month, Date, Hour, Minute, Second or Day of Week. Increment / decrement is done by 1. From these references, RTC counts all parameters with leap year compensation.

Click 'OK' to add task in task list.

### ● Print Data

This task is supported in key tasks only. Alphanumeric data displayed on current screen can be printed using this task. User has to define the port as 'Serial printer' for executing this task. Any of the two ports can be configured for printing and printing will be done from the port which is configured for printing as mentioned above.

### ● Copy NTXS Block to NTXS / PLC Block

This task is executed on register tags only. This task is used to copy unit tags to PLC tags. This is two byte copy

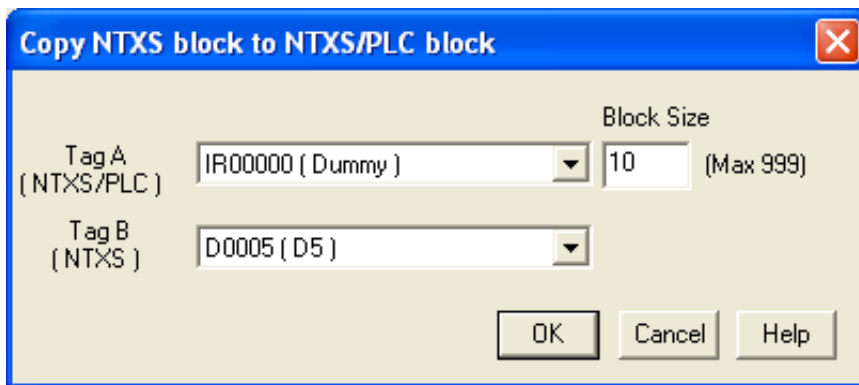

For e.g.- As shown above, 10 sequential unit tags starting from D0000 (i.e. D0000 to D0009) will be copied to 10 sequential PLC tags starting from IR00000 (i.e. IR00000 to IR00009).

Click 'OK' to add task in task list.

### ● Copy PLC Block to NTXS Block

This task is executed on register tags only. This task is used to copy PLC tags to unit tags. This is two byte copy command. Unit block means any unit tags or retentive memory area.

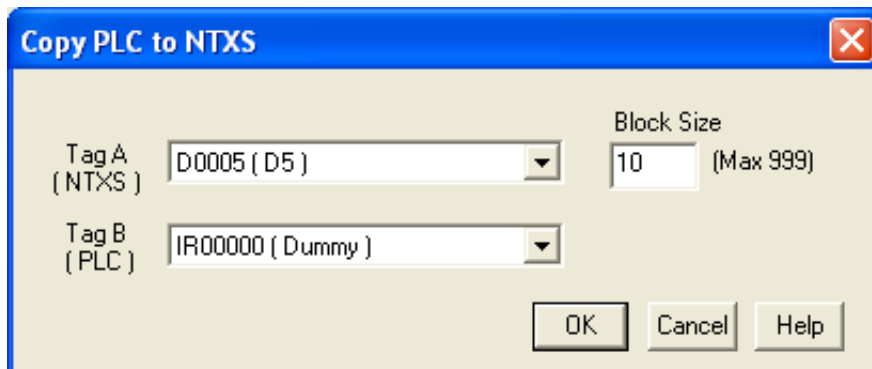

For e.g.- As shown above, 10 sequential PLC tags starting from IR00000 (i.e IR00000 to IR00009) will be copied to 10 sequential unit tags starting from D0000 (i.e. D0000 to D0009).

To prevent no. of write cycles to EEPROM (retentive memory area), this command is not supported in Global\_task-list and While showing task-list, if retentive register is selected as unit tag. Click 'OK' to add task in task list.

### ● Copy RTC to PLC Block

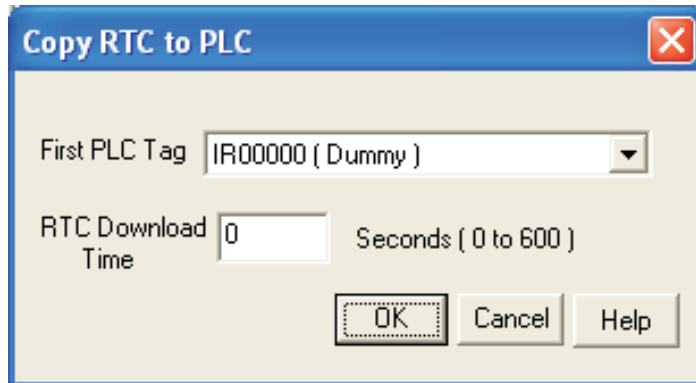

This task is supported only in Global task-list. This task copies sequentially 7 RTC parameters from selected tag after every specified RTC Download Time. If this time is specified as 0 sec. then it means this task will be executed as per Global task-list execution time.

Click 'OK' to add task in task list.

7 RTC parameters are copied in the PLC Tags starting from the First PLC Tag (IR00000 as shown above) following sequence-

- 1st Tag - Hours
- 2nd Tag - Minutes
- 3rd Tag - Seconds
- 4th Tag - Date
- 5th Tag - Month
- 6th Tag - Year
- 7th Tag - Day of week

### ● Goto Popup Screen

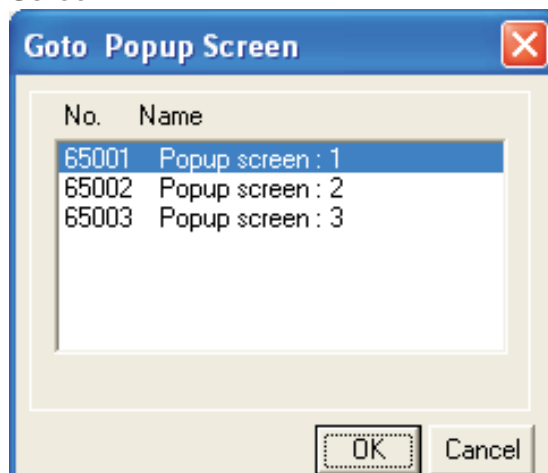

## Task Management

---

This task is supported in touch screen products only . User can select screen no. from available popup screen list .

Click 'OK' to add task in task list.

When this task is executed selected screen pops up on current screen . At a time only one screen can be popped up. By pressing right most corner 'X' close button you can close popup screen.

### ● Keys' Specific Tasks

This task enables user to define task which are specific for keys. This task is specially useful for editing data in the system or checking / acknowledging alarms. Following is the list of key's specific tasks:

**KEYs' specific tasks**

- Clear Data Entry
- Cancel Data Entry
- Accept Data Entry
- Switch to Next Data Entry
- Increase Value by 1
- Decrease Value by 1
- Increase Digit by 1
- Decrease Digit by 1
- Shift Value to Left
- Move Cursor to Left
- Move Cursor to Right
- Sign Key ( +/- )
- Sign Key ( +/- ) and 0

- Numeric Key 0
- Numeric Key 1
- Numeric Key 2
- Numeric Key 3
- Numeric Key 4
- Numeric Key 5
- Numeric Key 6
- Numeric Key 7
- Numeric Key 8
- Numeric Key 9

- Numeric Key A
- Numeric Key B
- Numeric Key C
- Numeric Key D
- Numeric Key E
- Numeric Key F

- Acknowledge Alarm
- Acknowledge all Alarms
- Previous Alarm
- Next Alarm
- Previous Historical Alarm
- Next Historical Alarm
- Clear all Historical Alarms

## Task Management

No.	Tasks	Description
1	Clear Data Entry	Clears active data entry value to 0.
2	Cancel Data Entry	Disables data entry
3	Accept Data Entry	Accepts edited data for current data entry and cursor jumps to next data entry object.
4	Switch To Next Data Entry	Disables previous data entry and switches to next data entry.
5	Increase Value by 1	Adds 1 to Tag value in data entry object.
6	Decrease Value by 1	Subtracts 1 from Tag value in data entry object.
7	Increase Digit by 1	This task is executed only on single digit shown by cursor. The digit scrolls between 0 to 9.
8	Decrease Digit by 1	This task is executed only on single digit shown by cursor. The digit scrolls between 0 to 9.
9	Shift Value to Left	Shifts value to left by padding zeros from right side.
10	Move Cursor to Left	Moves the cursor to the left. This task is not scrolling type so cursor moves upto number of digits in the data entry object.
11	Move Cursor to Right	Moves the cursor to the right. This task is not scrolling type so cursor moves upto number of digits in the data entry object.
12	Sign Key (+/-)	This task operates only on Signed data. On each event sign toggles between + and -.
13	Sign Key (+/- and 0)	For the first iteration this task acts as Sign Key. Then for each of the iterations, it acts as Numeric key 0.
14	Numeric Key 0	Allows user to enter '0' at cursor location, if selected tag is Register type. For Coil / Bit type, this task acts as 'Edit Bit Off'.
15	Numeric Key 1	Allows user to enter '1' at cursor location, if selected tag is Register type. For Coil / Bit type, this task acts as 'Edit Bit On'.
16	Numeric Key 2	Allows user to enter '2' at cursor location.
17	Numeric Key 3	Allows user to enter '3' at cursor location.
18	Numeric Key 4	Allows user to enter '4' at cursor location.
19	Numeric Key 5	Allows user to enter '5' at cursor location.
20	Numeric Key 6	Allows user to enter '6' at cursor location.
21	Numeric Key 7	Allows user to enter '7' at cursor location.
22	Numeric Key 8	Allows user to enter '8' at cursor location.
23	Numeric Key 9	Allows user to enter '9' at cursor location.
24	Numeric Key A	Allows user to enter 'A' at cursor location.
25	Numeric Key B	Allows user to enter 'B' at cursor location.
26	Numeric Key C	Allows user to enter 'C' at cursor location.

## Task Management

No.	Tasks	Description
27	Numeric Key D	Allows user to enter 'D' at cursor location.
28	Numeric Key E	Allows user to enter 'E' at cursor location.
29	Numeric Key F	Allows user to enter 'F' at cursor location. <b>Note: Numeric keys A to F are applicable for HEX data entry only.</b>
30	Edit Bit On	This task operates only on coil / bit tags. Coil / bit is set to 1 from this task.
31	Edit Bit Off	This task operates only on coil / bit tags. Coil / bit is set to 0 from this task.
32	Acknowledge Alarm	Acknowledges the first alarm (top position in the Real time alarm window)
33	Acknowledge All Alarms	Unlike Acknowledge Alarm task, this task acknowledges all alarms.
34	Previous Alarm	The alarm display position in the Real time alarm container is shifted one position up.
35	Next Alarm	The alarm display position in the Real time alarm container is shifted one position down.
36	Previous Historical Alarm	The alarm display position in the Historical alarm container is shifted one position up.
37	Next Historical Alarm	The alarm display position in the Historical time alarm container is shifted one position up.
38	Clear All Historical Alarms	Clears all the historical alarms.

**Note: Task 1 to Task 31 operates only for data entry object.**



## **USING LANGUAGES**

In this chapter. . . .

- ◆ Export Functionality
- ◆ Import Functionality
- ◆ Language Conversion Utility
- ◆ Language Wizard

## Language Wizard

---

### 7.1 Export Functionality

Export function extracts data from a NTXS project and puts it into a user-specified file. This file has extension **.out**. In this version, only **Text Data** is exported. Text Data includes all the texts ( also called text objects ) in wizards which can be defined in multiple languages. e.g. from a Bit Button, On Text, Off Text and Label Text are text objects which are exported. Export functions extracts texts from all wizards namely Bit Button, Word Button, Bit Lamp, Word Lamp, Meter, Multiple Bargraph, Numerical Keypad, Trend, Text Wizard.

Export function is added as **Export** menu option under **File** menu

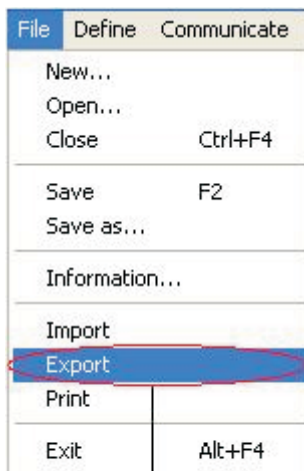

Export option

To export text objects-

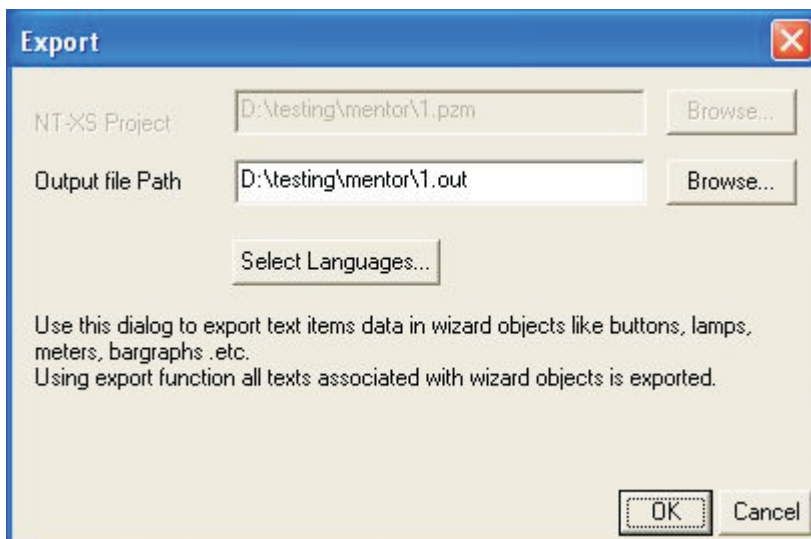

- 1) Specify NTXS project path
- 2) Output file path
- 3) Select languages for which you want the data to be exported. This window will display the only languages added in the Unit settings. For Example in the below window four languages Chinese (RPC), Japanese, Korean and Russian are added and selected. (See the check box)

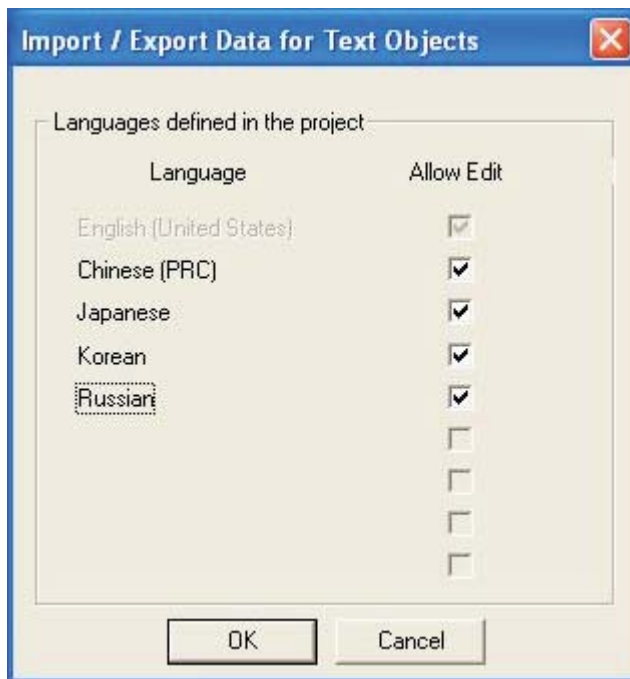

Text objects for all wizards on all screens will be exported to a binary file. In both Export and Import functions English is used as a reference language to identify a particular text object. For example, a Bit Button will be identified by "On", "Off" and "Label" text objects. Even if one of the texts changes, like "On" is made "aaa", it will be considered as another object.

After selecting the messages the software will show the completion message.

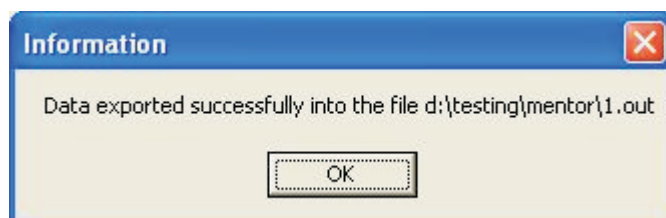

This operation will create a.out file on the same location where the application is stored.

## Language Wizard

---

### 7.2 Import Functionality

Import function is added as Import menu option under File menu.

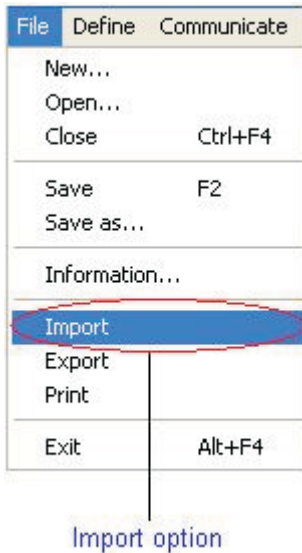

To import text objects-

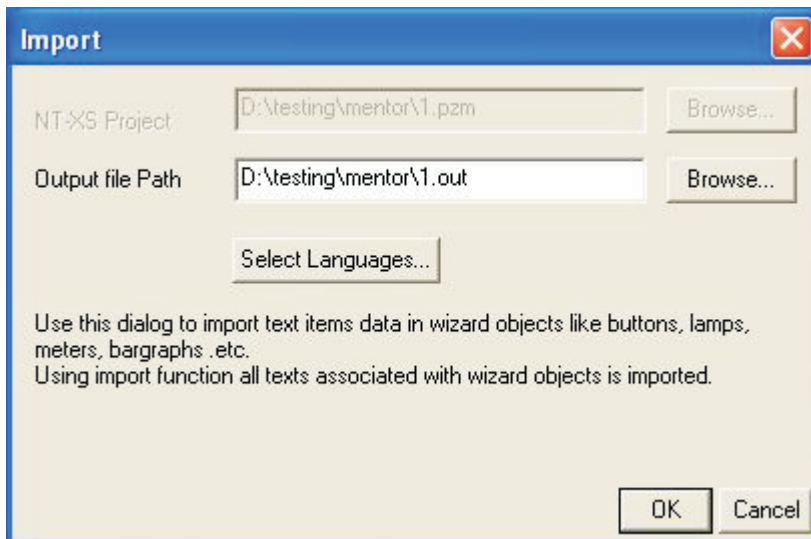

- 1) Specify NTXS project path.
- 2) Output file path.
- 3) Select languages for which you want the data to be imported. This window will display the only languages added in the Unit settings. For Example in the following window four languages Chinese (RPC), Japanese, Korean and Russian are added and selected. (See the check box)

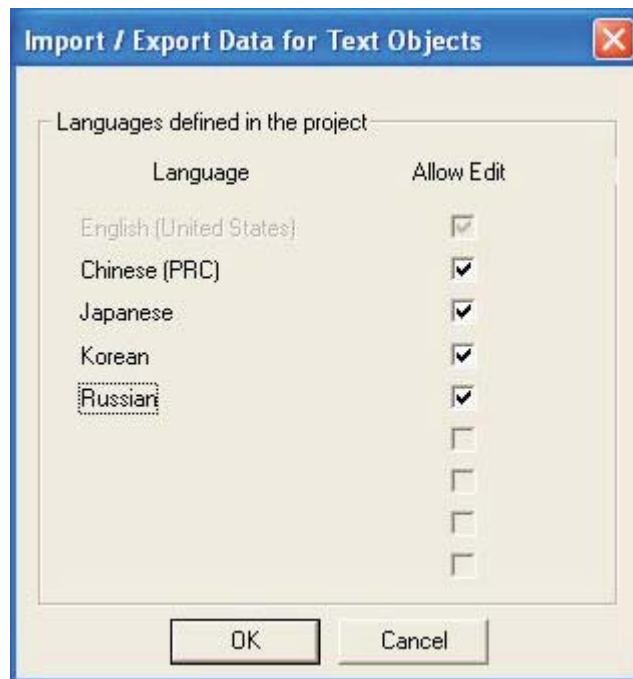

Text objects for all wizards on all screens will be imported from the specified binary file.

Errors will be displayed in case of -

Objects mismatch - For example, 2 bit buttons were exported but while importing one has been deleted or 1 Bit Button is exported. After exporting the On text ( in English Language ) of the same button has been changed and then data is imported. In this case the Bit Button's On Text in reference language is changed, so it is treated as a different object and error is displayed.

Language mismatch - If the data is exported in languages English, French and Japanese and while importing you specify English and Russian, this error will be displayed.

After selecting the messages the software will show the completion message.

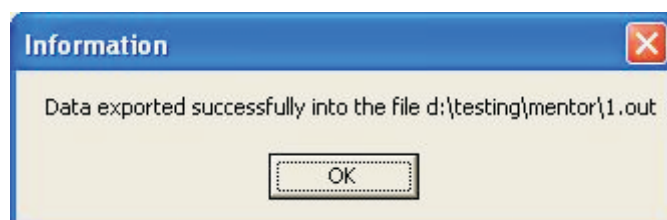

## Language Wizard

---

### 7.3 Language conversion utility

The purpose of the Language Conversion Utility is to be able to define text objects in language(s) other than the default language, which is English. To understand the concept, consider following example. Suppose a project is created for 2 languages, English and Russian. While creating the project, the text objects are defined only in English since the person who created the project does not know Russian. The first step in the language translation project is to export all of the text objects using the export function in the NTXS software. The next step is to send the exported file and the Language Conversion Utility to someone who will translate the English text objects into Russian. The last step is to import the text objects in the translated project. All of the text objects can now be viewed in Russian as well as English.

This utility reads the file exported by the application software and displays the text objects in a grid. Text data for all languages defined by the Unit Settings are loaded. Except for English, the data for any other language can be edited within the grid. When a text object is edited, the appropriate language keyboard is activated.

#### Language Conversion Utility – GUI

##### 7.3.1 File Menu

A user can open a *.out* file that has been created by the export utility from the menu bar. Be sure to use the right path of the *.out* file. The error message will be displayed for unrecognized *.out* files.

##### 1. Open Option in Menu bar

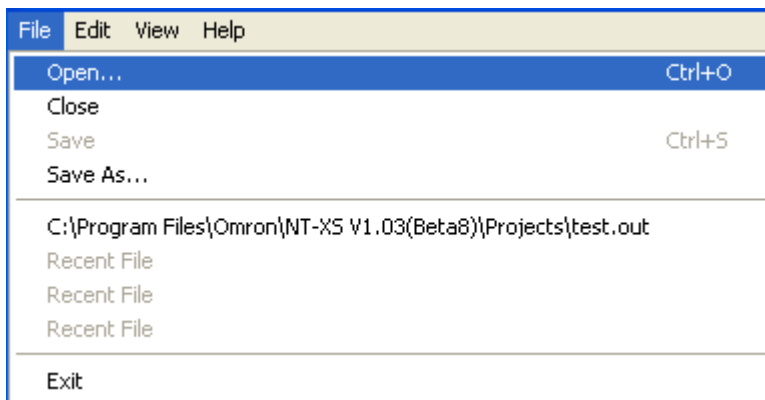

Click this menu option or Ctrl+O to open a *.out* file. A standard file open dialog box will appear. The valid file extension is *.out*. The *.out* files should be created by using the Export menu option in the NTXS software. Select a file and click Open button, or alternatively double-click on the file name. If the file is valid, the data in the file is displayed in the grid format. The grid has a minimum of 3 fixed columns:

1. **Serial No** : Displays the running serial number.
2. **Screen - Object** : Displays the screen number and object type information.
3. **English** : The English text associated with the object.

Additional columns will be displayed for each language configured in the project.

Select a grid cell and click on it to change the data. Depending on the language of the column, the appropriate keyboard layout will be loaded.

## 2. 'Close' option in menu bar

A user can close the *.out* file from the menu bar.

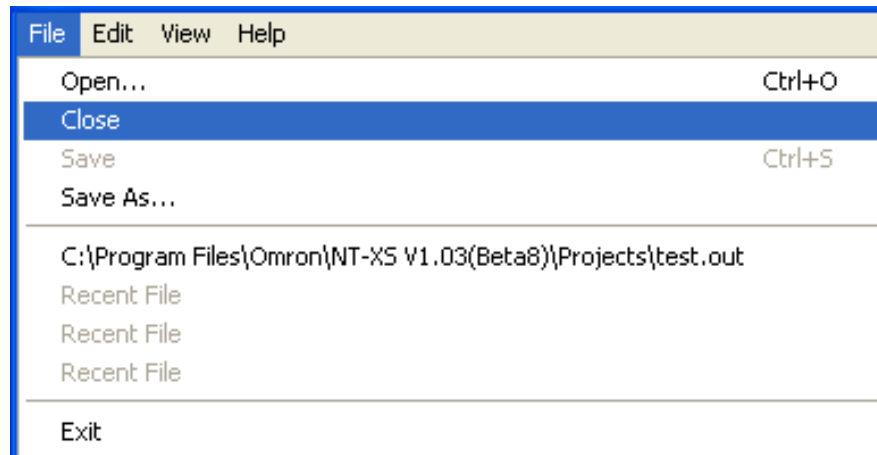

Click this menu option to close the currently open file. The user is prompted to save the file, if it has been modified since the last save operation.

## 3. "Save" option in menu bar

A user can save the *.out* file from the menu bar.

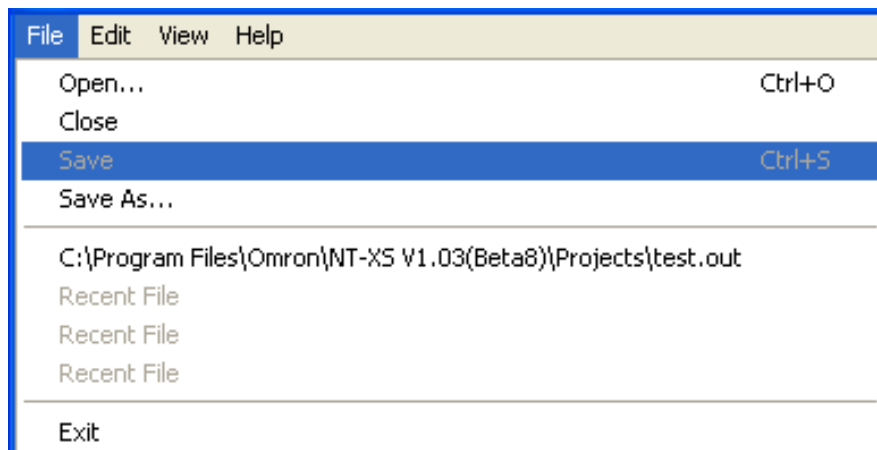

Click this menu option to save the currently open file. This menu is enabled only when the file has been modified.

## Language Wizard

---

### 4. “Save As” option in menu bar

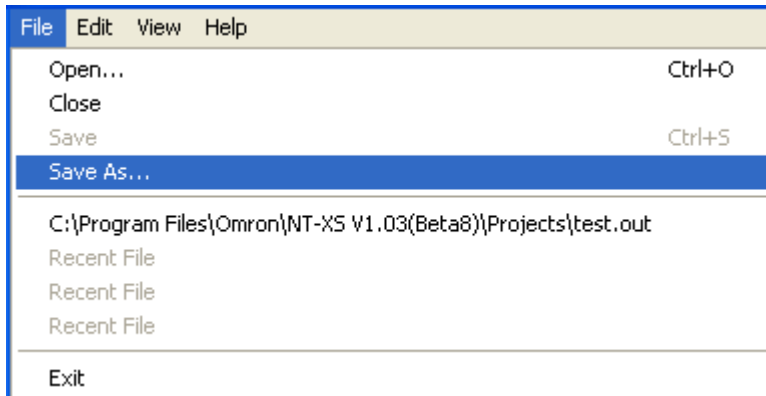

Click this menu option to save the current file as another file.

### 5. Recent File:

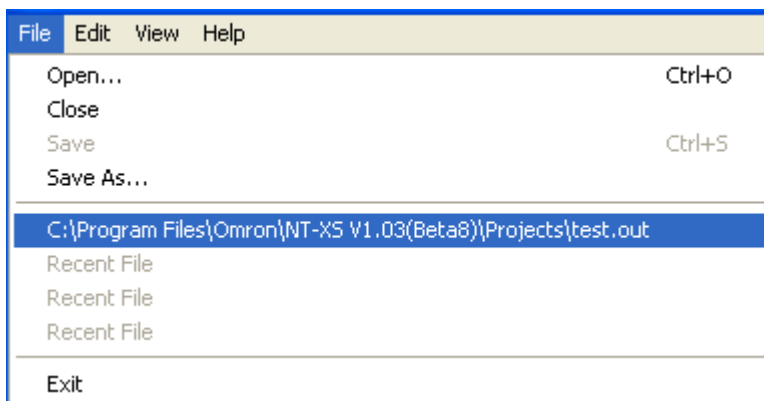

The recent file list contains the last 4 most recently used files.

### 6. “Exit” option in menu bar

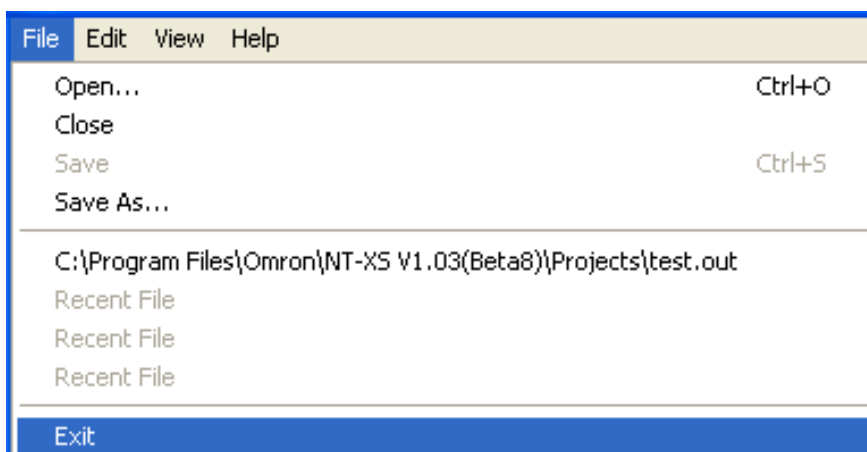



### 7.3.2 Edit Menu

**Cut** : Click this menu option or **Ctrl+X**, to cut a selected cell's data and copy it to the clipboard.

**Copy** : Click this menu option or **Ctrl+C**, to copy a selected cell's data to the clipboard.

**Paste** : Click this menu option or **Ctrl+V**, to paste the previously copied data to the selected cell.

### 7.3.3 View Menu

**Toolbar** : Click this menu option to toggle the toolbar.

**Status Bar** : Click this menu option to toggle the status bar.

### 7.3.4 Help Menu

This menu option opens the About dialog box. It will display the Renu logo, software version number, software version date information.

## 7.4 Multi-Language Text Wizard

The Multi-Language Text Wizard allows the designer to configure text objects for use in a multiple language project.

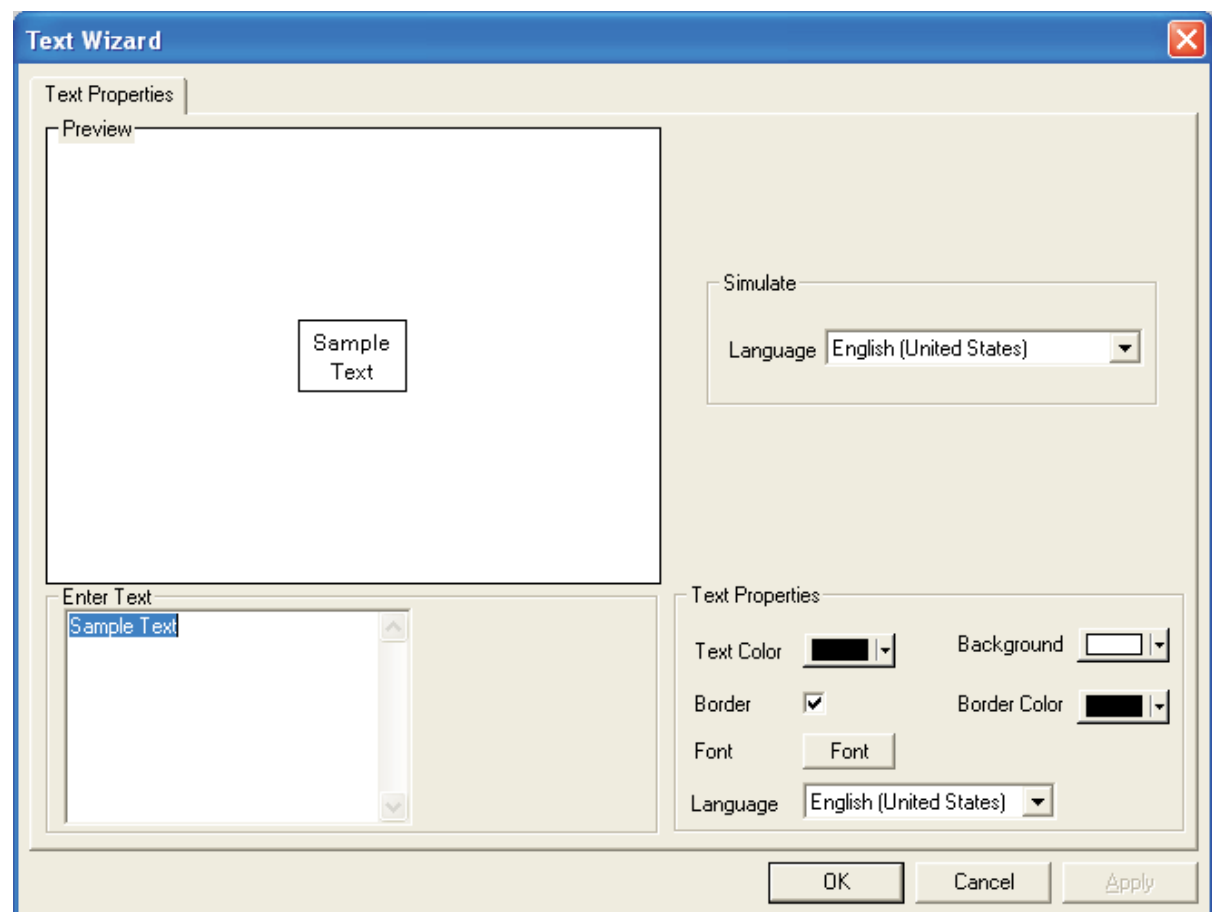

## Language Wizard

---

### Text properties

1. **Text** : The object can have a maximum of 150 characters.
2. **Text color** : Sets the text color from the palette.
3. **Background** : Sets the Background text color from the palette.
4. **Border** : If enabled, the text object will have a border.
5. **Border Color** : Sets the color of the border from the palette.
6. **Font** : Selects Windows® Font, Font Style and Font size.
7. **Language** : Displays the list of languages configured in the Unit Settings.

### Simulate

A user can preview the text configured for each language configured in the wizard in the preview window.

### 7.4.1 Configure Languages

NT3S products support multiple languages. User can configure project with different 9 languages. Language Register S1 controls the language to be displayed in the unit. This feature is supported for following wizard objects.

1. Multilanguage Text Wizard
2. Bit Button / Bit Lamp
3. Word Button / Word lamp
4. Analog Meter
5. Multiple Bargraph
6. Numeric Keypad
7. Trend

Following screen shows how to configure multiple languages for a project. Select **Configure Language** option from **Unit Settings**. Following screen will appear.

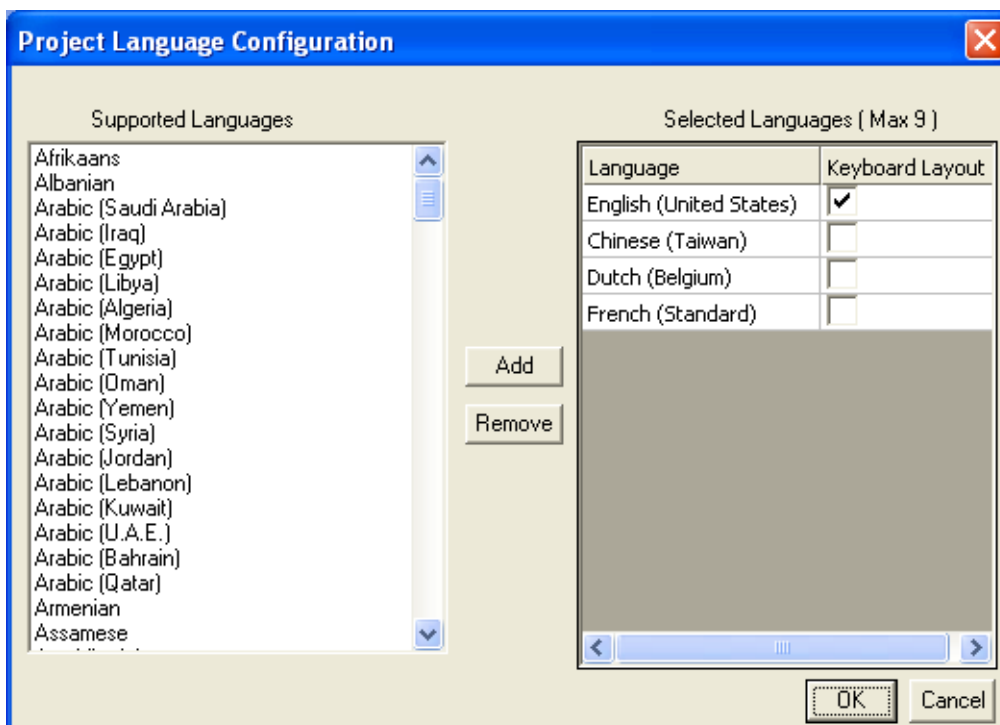

The list box on the left side shows which languages are installed on your computer. The list box on the right side lists the languages to be used in the project. The languages must be installed on your computer to appear in the installed languages list.

### Keyboard Layout

By default, for selected languages, English keyboard layout is loaded. User needs to select keyboard layout if he wants the characters in the selected language, other than English. For example, For typing characters in East Asian languages like Japanese, Chinese, Hindi etc., keyboard layout selection is necessary. In order to select the keyboard layout, languages must be installed on the machine. Language bar in the Windows task bar shows list of installed languages on your machine.

For languages having same character set as English, e.g. French, Spanish etc., keyboard layout selection is optional. Select keyboard layout only if you need to modify keyboard character set functionality.

How to install languages on the machine

Select the **Regional and language option** from Control panel menu as shown below.

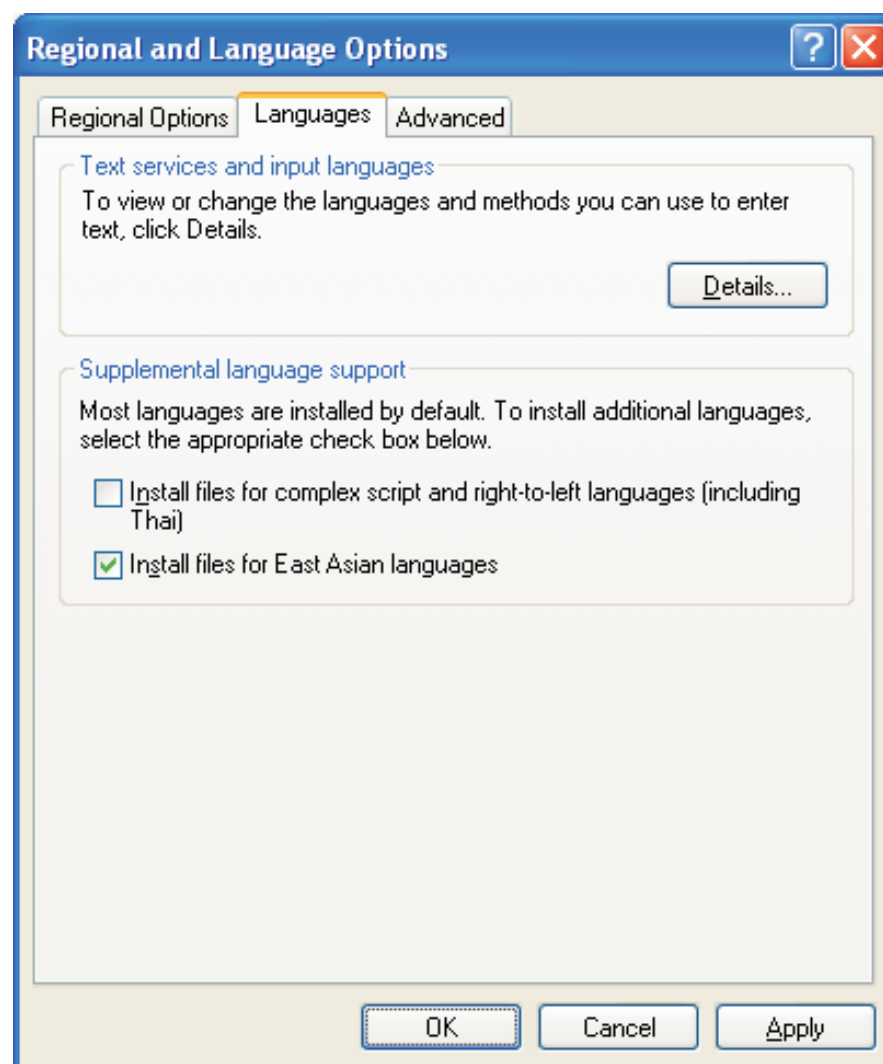

## Language Wizard

---

Once languages are installed on your machine these can be selected using following screen located under Regional and language options.

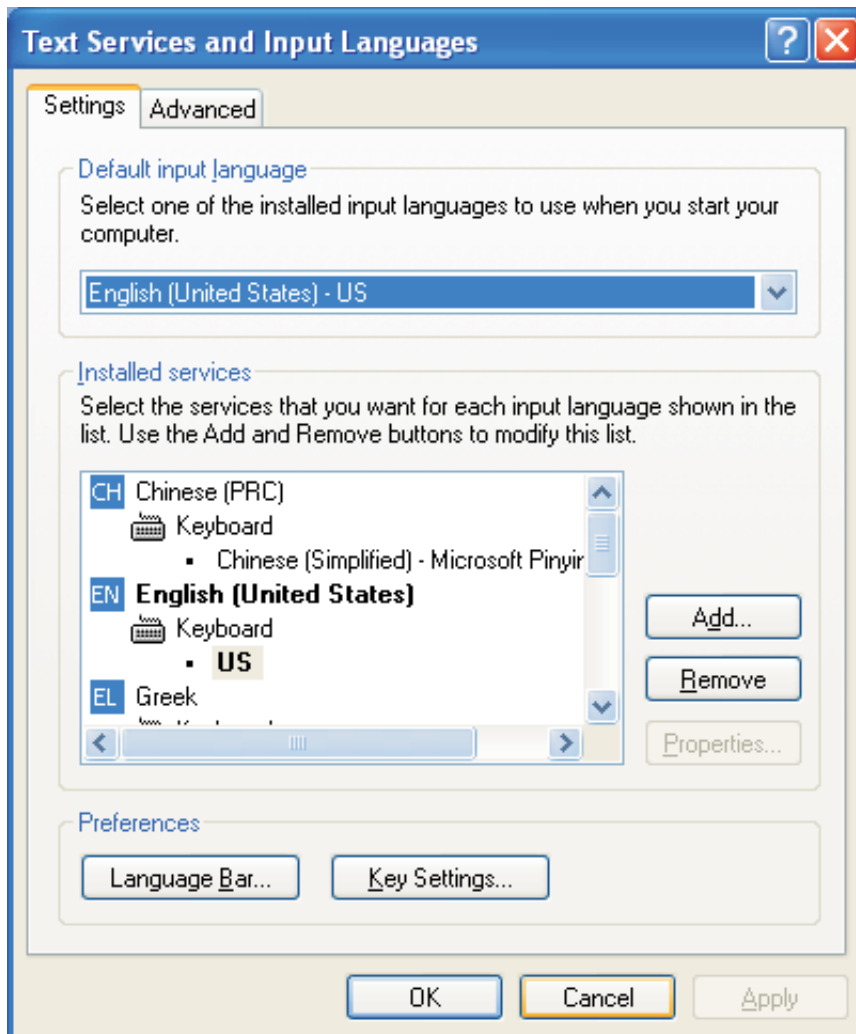

**Note:** Parameters not supported for the product are grayed out.

## 7.4.2 Displaying Multiple Languages in Unit

System Register S0001 controls the language to be displayed at run time. User can use 'Write value to tag' task for changing value in system register.

**Note :** If S0001 has value other than 1 to 9 then English language is displayed.

**Example:**

If user has configured project for 3 different languages namely English, Korean, Japanese then following tasks can be used to change language at run time.

English - Write value to Tag S0001 with value 1

Korean - Write value to Tag S0001 with value 2

Japanese - Write value to Tag S0001 with value 3

In this way 9 different languages can be displayed in unit at run time. Following table shows the value of System Register S0001.

Language Tag Value	Description
0	Default Value : English
1	English
2	Configurable Language
3	Configurable Language
4	Configurable Language
5	Configurable Language
6	Configurable Language
7	Configurable Language
8	Configurable Language
9	Configurable Language

### **UPLOADING AND DOWNLOADING FROM UNIT**

In this chapter. . . .

- ◆ Upload an Application
- ◆ Download an Application
- ◆ Error Catalog

### 8.1 Upload

User can upload an application from NTXS unit. From '**Communicate**' menu, click '**Communication Port**', select the appropriate communication port of your PC. Attach PC to NTXS cable. For uploading, choose **Communicate|Upload..** menu option.



OR

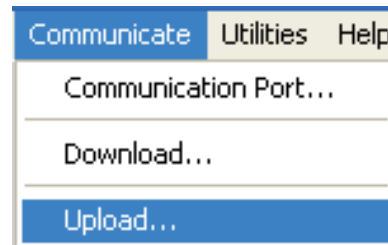

In the Upload dialog box, press '**Upload**' button to upload an application from NTXS unit.

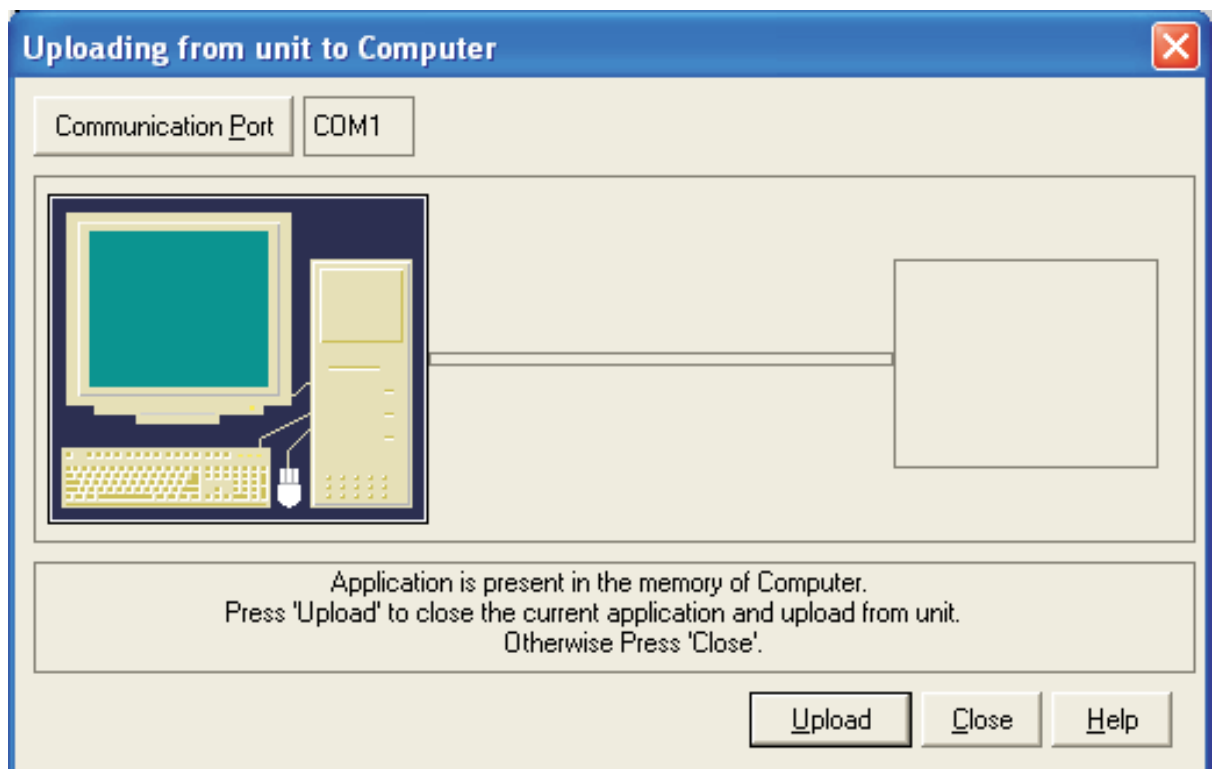

User can upload the application from the unit to the software from this dialog. Please check the unit and cable connections before starting upload.

**Communication Port** – User has to define communication port for uploading. By default Com1 is selected.

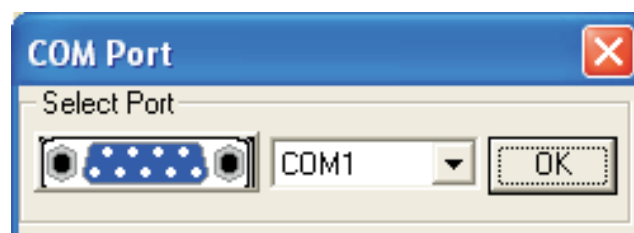

## Uploading and Downloading from unit

---

During uploading following errors may occur

### 1 Unit is not responding

This error indicates that no communication has been established between the computer and the NTXS unit. Check the COM port selection and cable connections.

### 2 Unit is not responding after frame number XXXX

Communication with unit has been lost. Try uploading again. You may need to close the NTXS program and restart it.

## 8.2 Download

When user clicks 'Download' button from Toolstation or chooses **Communicate|Download** menu, a DOS window appears for a moment to link PLC drivers with firmware as per application.

Once compiling of project is done then following window will display.

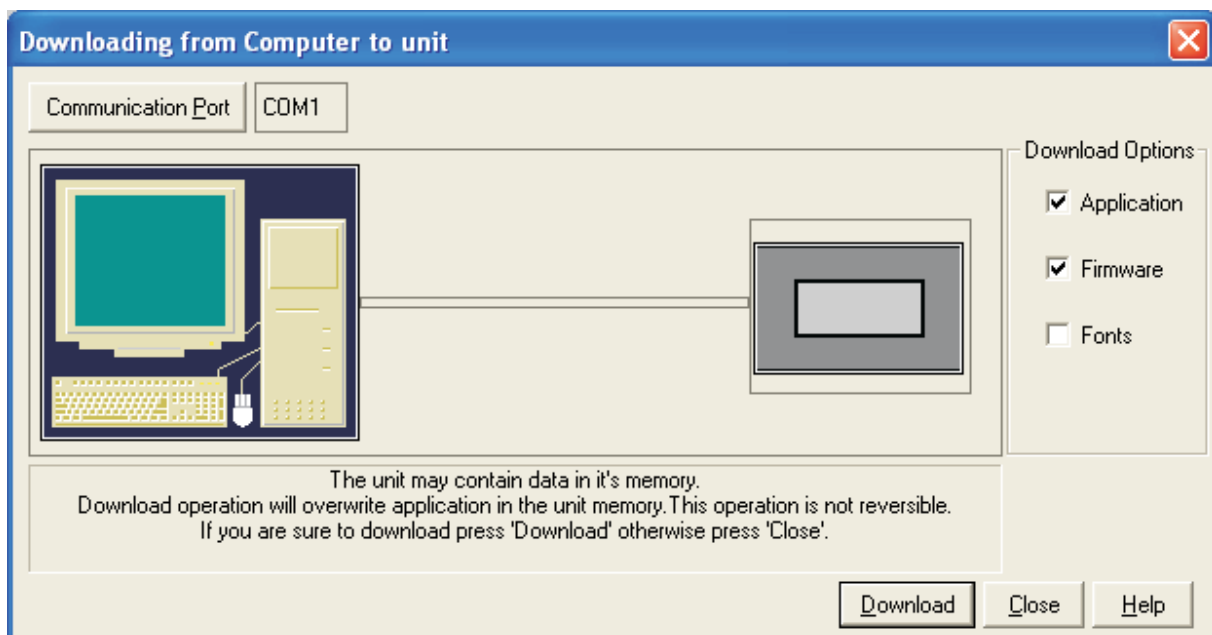

**Communication Port** – User has to define here communication port for downloading. By default Com1 is selected.

**Download** – User has to select proper option to download.

1. Firmware
2. Application
3. Fonts

### Application

Select this option to download application to unit.



### Firmware

Firmware needs to be downloaded for following -

1. Before downloading application first time to unit.
2. If new PLC node is either added or deleted from Network configuration.
3. Upgrading firmware in the unit to new version.
4. Before downloading applications, which are created in older versions of software.

### Fonts

Select this option to download the fonts to the unit. This option needs to be selected especially if default fonts are modified.

**Download Button** - Click this button to start downloading. While downloading following error may be occur -

#### 1. Unit is not responding.

This is communication error. Please check the cable, connection, display type compatibility.

#### 2. Selected NTXS model is not matching with unit connected on IBM port.

This error indicates product mismatch. Please check that the model defined in an application is correct and retry.

### 8.3 Error Catalog

#### 1. NTXS is not responding.

This error indicates that no communication has been established with unit. Please check cable connection before you start downloading again.

#### 2. Selected NTXS model is not matching with NTXS unit connected on IBM port.

This error indicates product mismatch. Please check that the model defined in an application is correct and retry.

#### 3. No driver found for selected NTXS model.

This error indicates that driver for selected PLC is either not supported or missing. This error is displayed during firmware download, if PLC driver for selected PLC node in NTXS application is not found. Check whether you have defined correct NTXS model and PLC node in your application. If you have defined correct PLC node and still error is displayed then please contact your vendor for support.

#### 4. Number of Blocks used in screen number XXXX has exceeded the maximum limit of 256 words. Delete or change some of the entities to avoid overflow.

The number of blocks embedded per screen is limited. For the rest of products, this limit is 256 words. If this number is exceeded, the above error is generated. To avoid this, delete or change some of the tags on screen, so that the number of words on screen will be within the maximum limit.

## Uploading and Downloading from unit

---

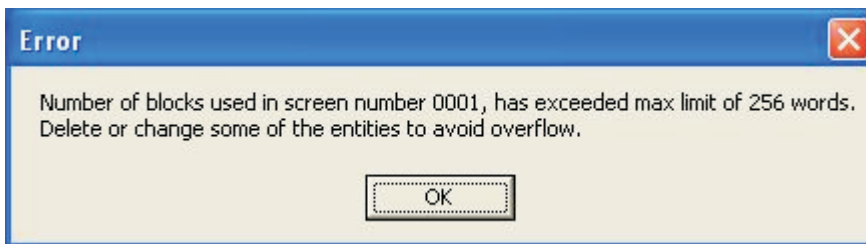

### 5. Can not download application.

If this error message occurs, then the application cannot be downloaded. To make the application downloadable delete or change some of the tags on screen, so that the number of words on screen will be within the maximum limit.

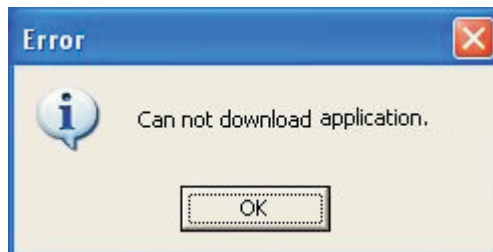

## ALARMS

In this chapter. . . .

- ◆ Define Alarm
- ◆ Using Alarm Window
- ◆ Difference between Real Time & Historical Alarm

## Alarm

---

### 9.1 Define Alarm

Alarm will be displayed in the alarm window only if it is defined from the '**Define Alarm**' menu.

There are two categories of alarm

1. **Real time alarms:** Stored & displayed as long as unit power is ON.
2. **Historical alarms:** Stores alarms in memory with battery back up.

**Note:** Historical alarms are only supported for the units with RTC / Battery backup.

In case of historical alarms the alarms defined with "Historical attribute" are logged till the unit is ON. Then even though you turn the unit OFF & then back ON after few days you can still view the alarms that were present when the unit was ON earlier.

The alarm object displays the alarm text when the alarm occurs. First triggered alarm is on top. Alarm condition for alarm should be cleared. Each alarm has to be acknowledged. 'Acknowledge Alarm' key acknowledges the alarm. The alarm text is cleared when the alarm condition is cleared and the alarm is acknowledged. Alarm text for unacknowledged or uncleared alarm will not be cleared. Any tag can be continuously monitored by defining alarms for each bit of that tag. To display an alarm on the screen as soon as it is triggered, alarm object has to be placed on the screen. An alarm is triggered for each bit in a tag. If the value of the particular tag becomes nonzero, corresponding alarm is displayed in the alarm object.

An alarm is a bit in a particular 2-byte tag. This two-byte tag is defined as a particular group in the alarm definition table. Since a two-byte tag contains 16 bits one such tag can generate 16 alarms. So to define 64 alarms we need to create 4 groups with 4 different two byte tags & define one alarm per bit in that. In total you can define up to 256 real time & 30 historical alarms.

### 9.1.1 Alarm Definition

The alarms can be defined in the following screen

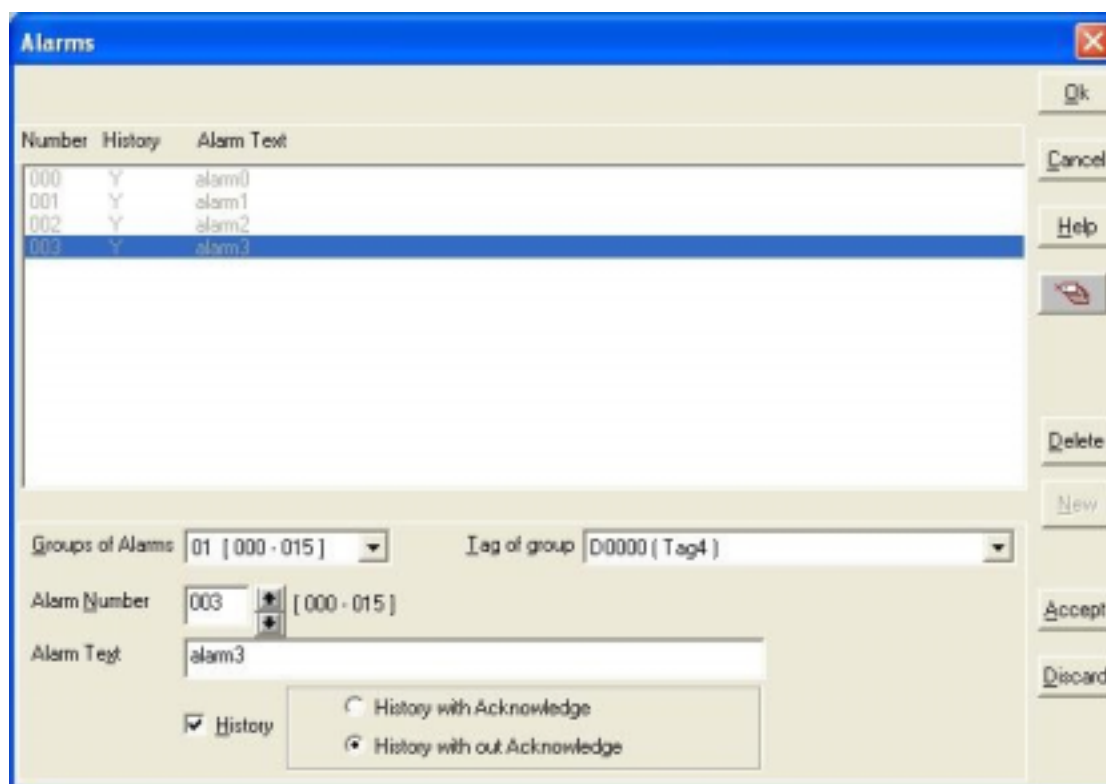

1. Group of alarms – Each tag must have a unique group of alarms associated with it. There can be 16 different groups of alarms.
2. Tag of group – A two byte tag for the defined group
3. Alarm number – The unique number of the alarm also indicating the position of the alarm bit in the defined alarm tag
4. Alarm text – The text that is displayed as alarm text in the alarm window
5. History – If this option is selected then the defined alarm is also logged in the memory as a historical alarm. There are two types of historical alarm:
  - History with Acknowledge** - Whenever the alarm comes, this will get added in the historical alarm container. And if the same alarm is already present in the alarm container then the previous one will get overwrite by the new one. At the same time, the acknowledgement task will be used for considering the same alarm as a new event.
  - History without Acknowledge** - Whenever the alarm comes, this will get added in the historical alarm container. And if the same alarm is already present in the alarm container then the new one will be considered as a new alarm. The acknowledgement task will not be having any effect
6. Add button – Add a new alarm in the alarm definition window
7. Delete button – Deletes selected alarm from the table
8. Accept button – When user needs to change attributes of any defined alarm then he can select the alarm, do the necessary changes & can press this button to save the changes
9. Discard button – This button acts as cancel button while doing changes to existing alarm.

## Alarm

---

### 9.1.2 Alarm Object

The alarm window object displays the real time or historical alarms in user-defined format.

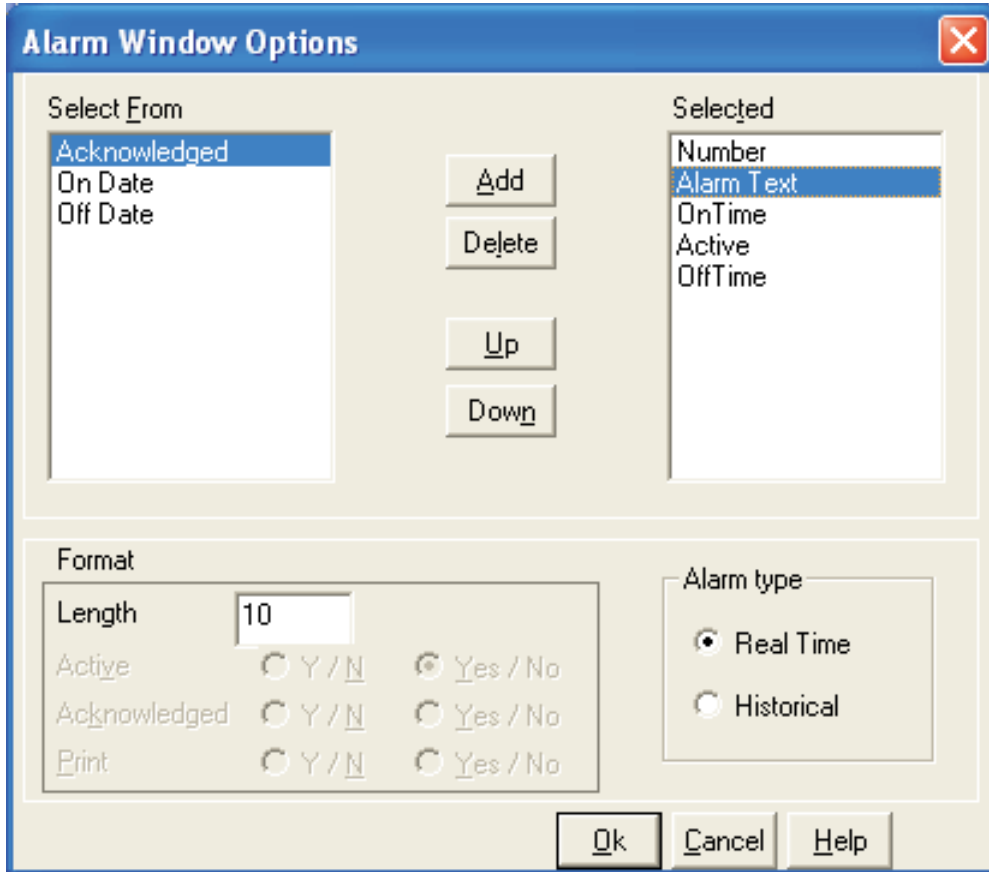

#### Select From

This list contains the available columns that can be viewed in an alarm display. Highlight the desired attribute(s) and click on Add button. The attribute is added to the Selected field.

The attributes can be

1. Alarm Text : Text defined for the alarm.
2. Number : Number defined for the alarm.
3. Active : The present status of the alarm [Active/inactive].
4. Acknowledge : The status of the acknowledge attribute for the alarm.
5. On time : The time at which the alarm made transition from OFF to ON state.
6. Off time : The time at which the alarm made transition from ON to OFF state.
7. On date : The date at which the alarm made transition from OFF to ON state.
8. Off date : The date at which the alarm made transition from ON to OFF state.

**Note:** The active and acknowledge attributes are not applicable for historical alarms.

#### Selected

This list gives the attributes that are selected and will appear in an alarm display. To deselect the unwanted attribute(s), highlight them and choose Delete button.

### Alarm type

This selection specifies whether the current alarm window represents the real time or historical alarms.

**Note:** Historical alarms are Product dependent.

### Format

Enter the format for the highlighted attribute from Selected field.

For Alarm Text attribute, user can enter the length in '**Length**' field.

For Time attribute, user can select the format as either HH:MM:SS or MM:SS from the combo box.

For Active and Acknowledged attributes, user can check the desired radio button.

### **PRINTING**

In this chapter. . . .

- ◆ Printing from NTXS unit
- ◆ Printing from NTXS Software
- ◆ Printer Port Setup



### 10.1 Printing from NTXS unit

1. Configure printing port by selecting Baud rate, Parity and No of Bits from Network Configuration.

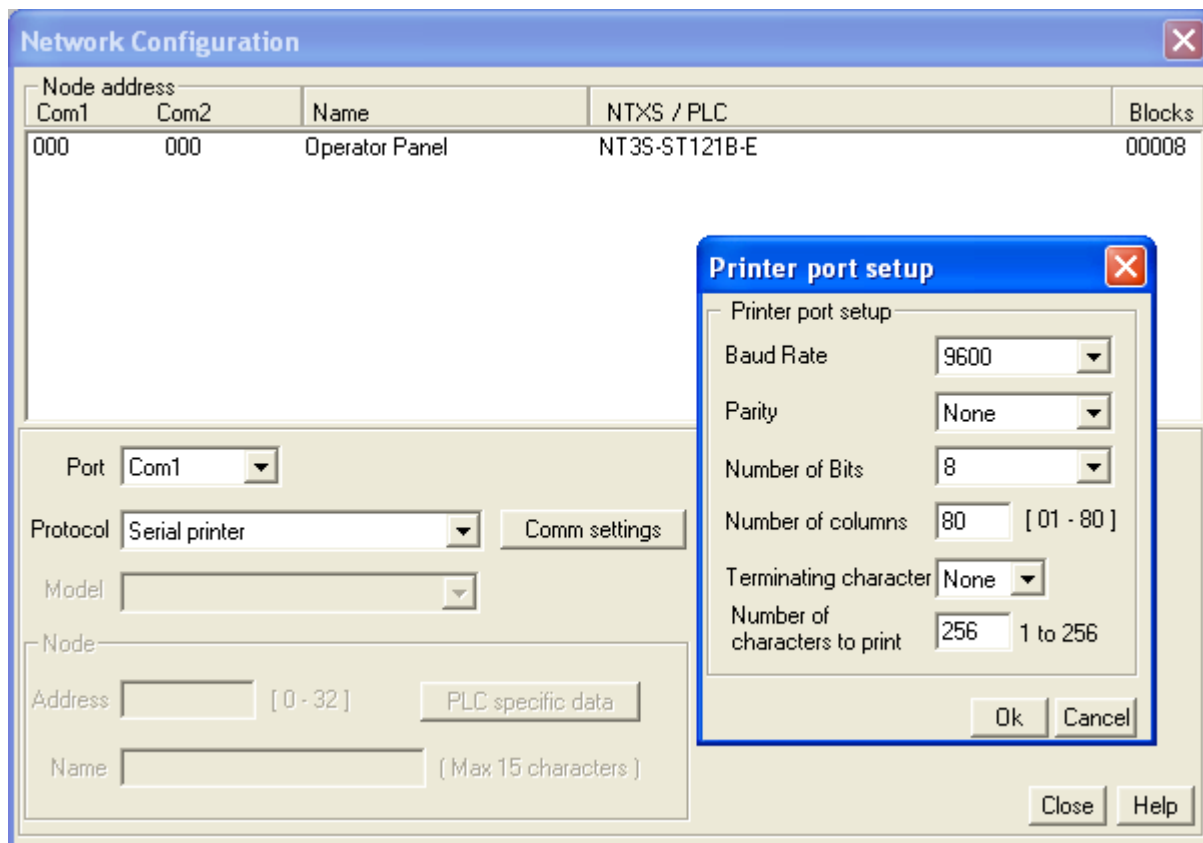

2. Presentation of screen on printer page decided by No of Columns, Terminating Character and number of characters to print.
3. Number Of Columns : By default this field is set to 80. But user can set any value upto column width of printer. Maximum limit is 80.
4. Terminating Character : By default this char is NONE, options are given below :

*NONE* : No char.  
*CR* : Carriage returns.  
*LF* : Line Feed.  
*CR + LF* : Carriage return + Line Feed

NTXS will send selected terminating character after completion of number of characters decided in No of column field.

5. Number of characters to print: User can select how many characters he want to print from screen. Please note that user cant select starting location for printing, it is always Considered as a top left of the screen.

## Printing

---

### Examples:

Considering Printer column width is 80.

1. **No Of Columns** - 80  
**Terminating Char** - NONE

**Result** - After printing 80 chars, carriage of printer comes to next New line automatically.

2. **No Of Columns** - 50  
**Terminating Char** - NONE

**Result** - As there is no terminating char , printer will print continuous 80 char from screen and then carriage of printer comes to next new line automatically.

3. **No Of Columns** - 50  
**Terminating Char** - CR

**Result** - After printing 50 chars carriage will return to starting location of same line.

4. **No Of Columns** - 50  
**Terminating Char** - LF

**Result** - After printing 50 chars, printer will insert 1 blank line of column width. And from same location next 50 characters will print.

5. **No Of Columns** - 50  
**Terminating Char** – CR + LF

**Result** - After printing 50 chars , printer will insert 1 blank line of column width and carriage will return to home position.

**Note:** Printer can print 5 X 7 font in same proportion. But if user selects bigger font size, then number of spaces will be inserted in two characters as per font size.

### 10.2 Printing from NTXS Software

User can print the NTXS application from menu bar. Choose **File|Print** menu option for printing the application..

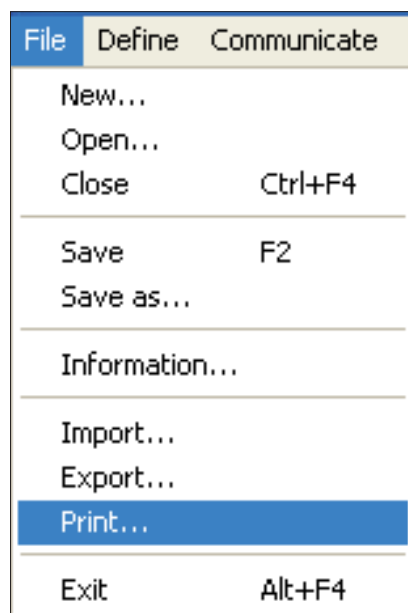

For printing, user should close the screen session first.

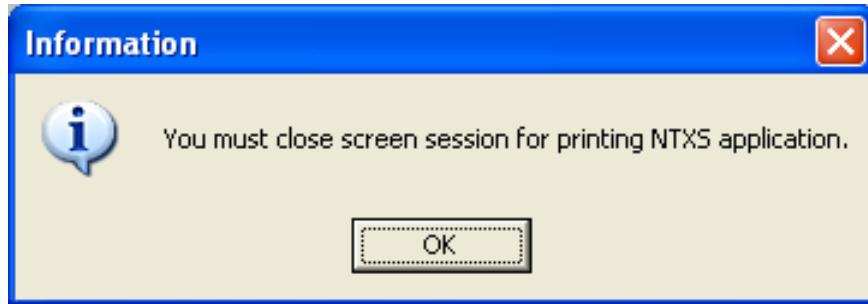

Click on 'Print' icon from menu bar. Following screen will appear.

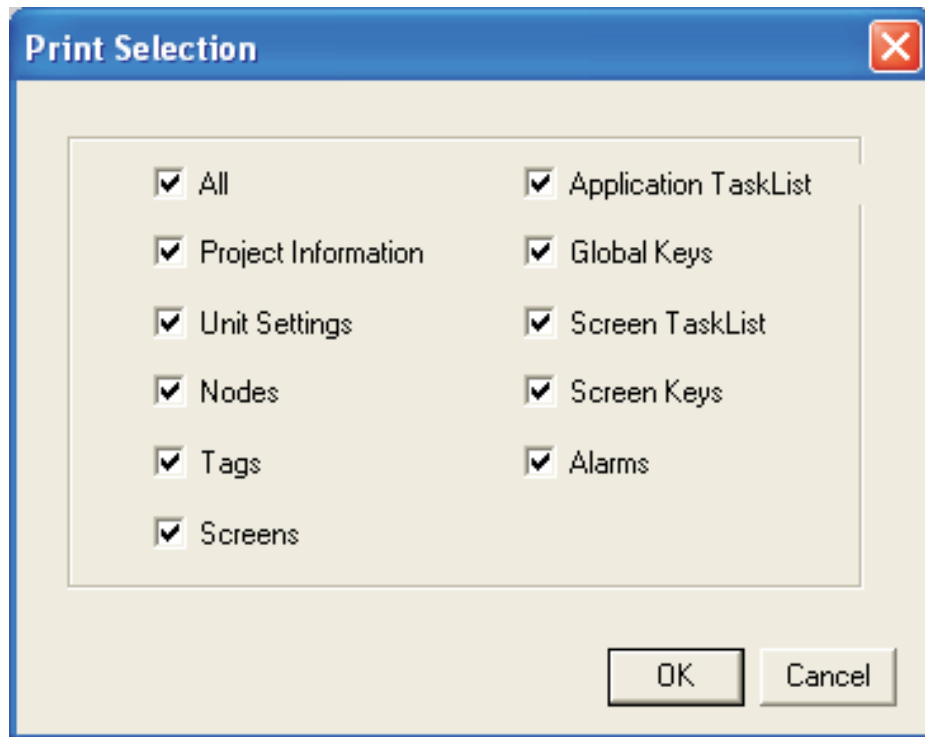

Screen shows different attributes such as 'Project Information', 'Unit Settings', 'Tags' etc. User can print the current application information either by selecting 'All' or by selecting specific attributes.

Select particular attributes and click 'OK' for printing the selected current application information.

**Note:** The above screen is for NT2S models. For NT3S models, Global keys and Screen keys attributes are grayed out.

### MISCELLANEOUS

In this chapter. . . .

- ◆ Convert Application
- ◆ NTXS Memory Status
- ◆ Font Editor
- ◆ Image conversion to bmp

## 11.1 Convert Application

This utility allows you to convert the application of one product into the other product.

NT3S-ST121B-E and NT3S-ST123B-E support RTC. But NT3S-ST124B-E and NT3S-ST126B-E do not support RTC. So the application of NT3S-ST121B-E is compatible for the product NT3S-ST123B-E without removing any task associated with RTC. In the same way the application of NT3S-ST124B-E is applicable to the product NT3S-ST126B-E. This saves the time required for creating new application.

But if you want to convert an application from NT3S-ST121B-E, which supports RTC, to the NT3S-ST124B-E, which does not support RTC, software will not allow such conversion. In such case you have to remove all the tasks associated with the RTC from the application of NT3S-ST121B-E.

When you click on “Convert application” tool, first it will display the message for closing the screen session as follows.

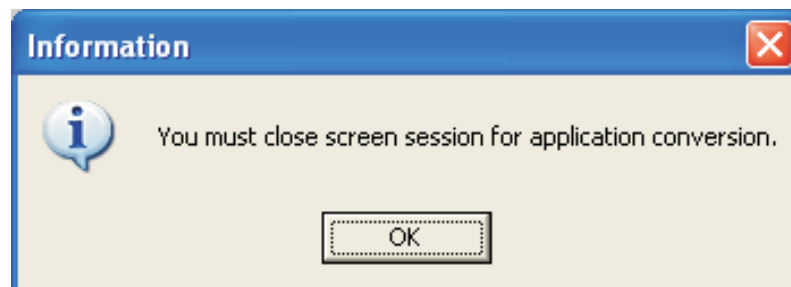

When you click on OK, it displays the list of other products in which application can be converted.

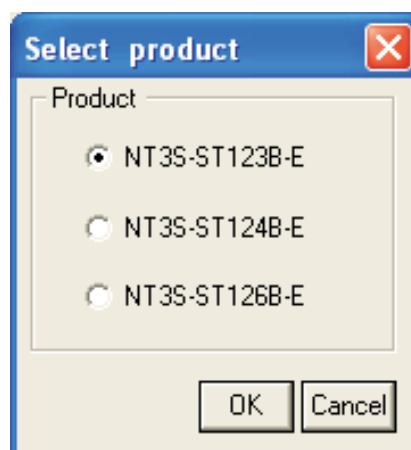

Select the desired product and click on OK. It will ask for the confirmation and converts the application.

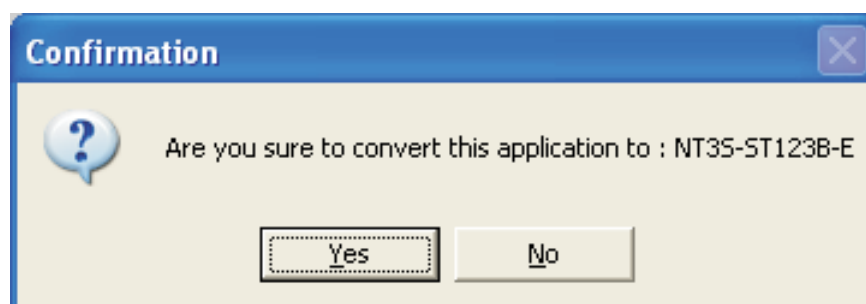

## Miscellaneous

### 11.2 Memory Configuration Wizard

User can see the memory status of his application from Memory Configuration Wizard. It gives information about the available memory of the application, the used memory in the application and the free memory in terms of Bytes, KB and percentage.

Memory Configuration Wizard can be opened from Utility Menu.

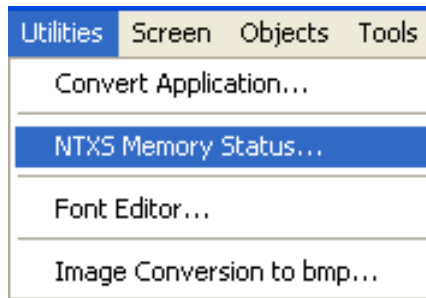

After selecting NTXS Memory Status following window will be displayed.

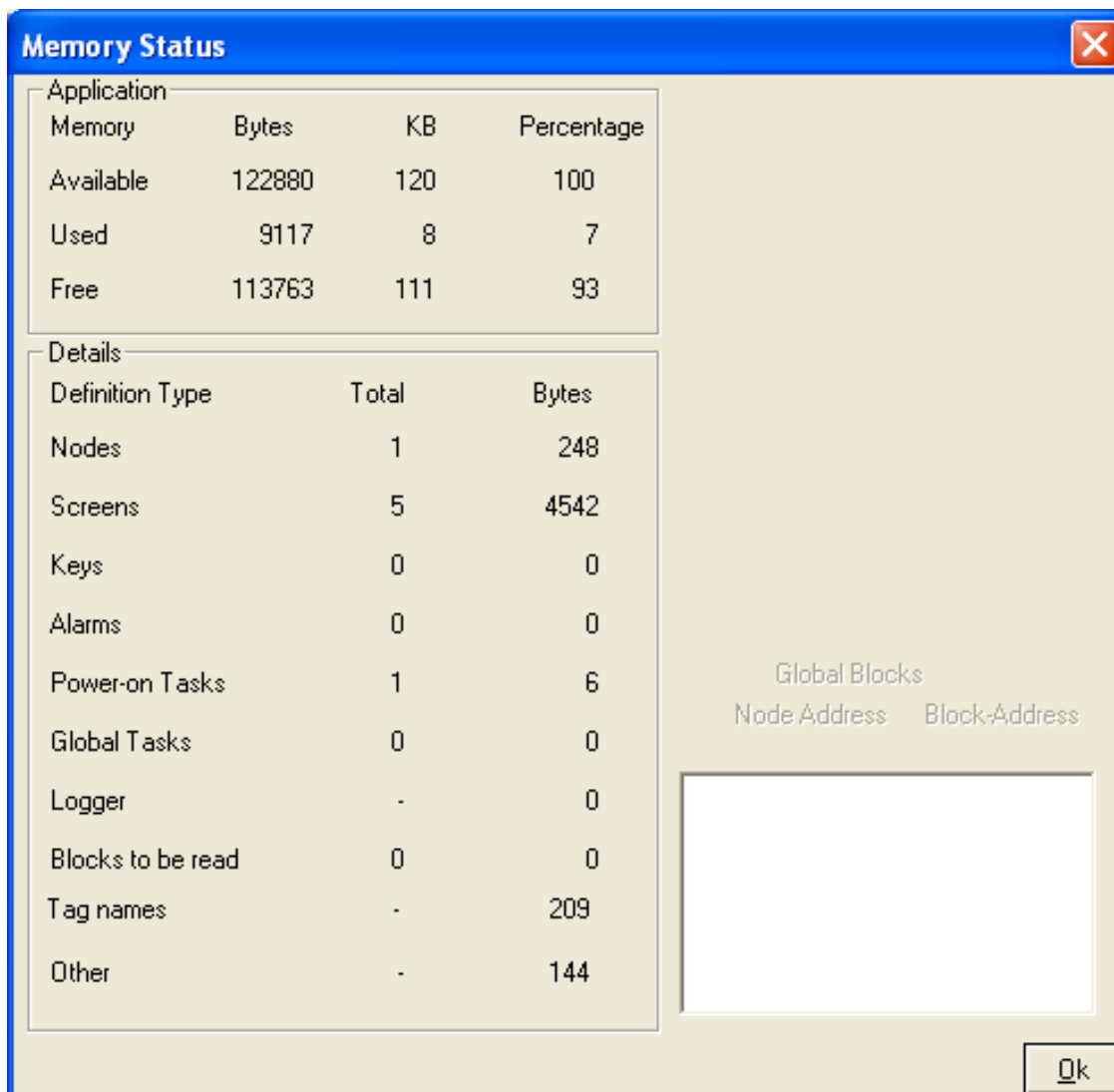

### 11.3 Font Editor

Font Editor is used to edit the different fonts of different sizes. NTXS Editor has four types of fonts

1. 5 X 7
2. 7 X 14
3. 10 X 14
4. 20 X 28



Characters for these fonts can be edited and modified using font editor utility under Utilities Menu.

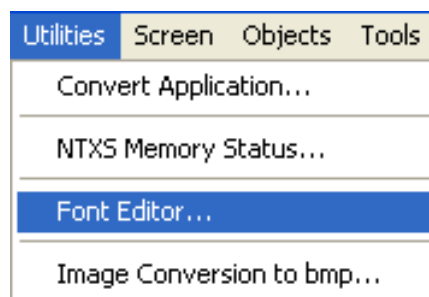

While selecting Font Editor from the utility menu the screen should be on the lowest zoom level only. If it is not, then the software will display the following message.

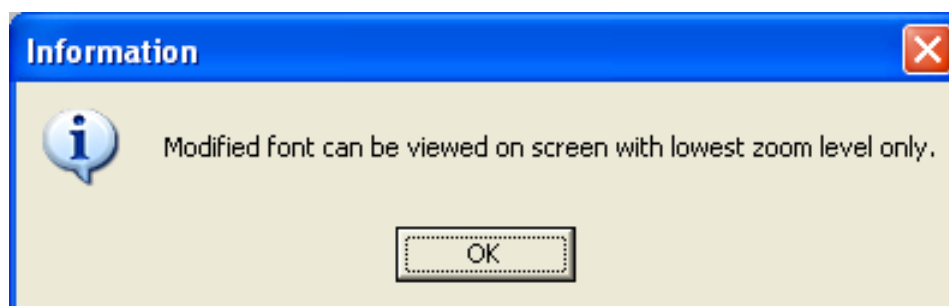

## Miscellaneous

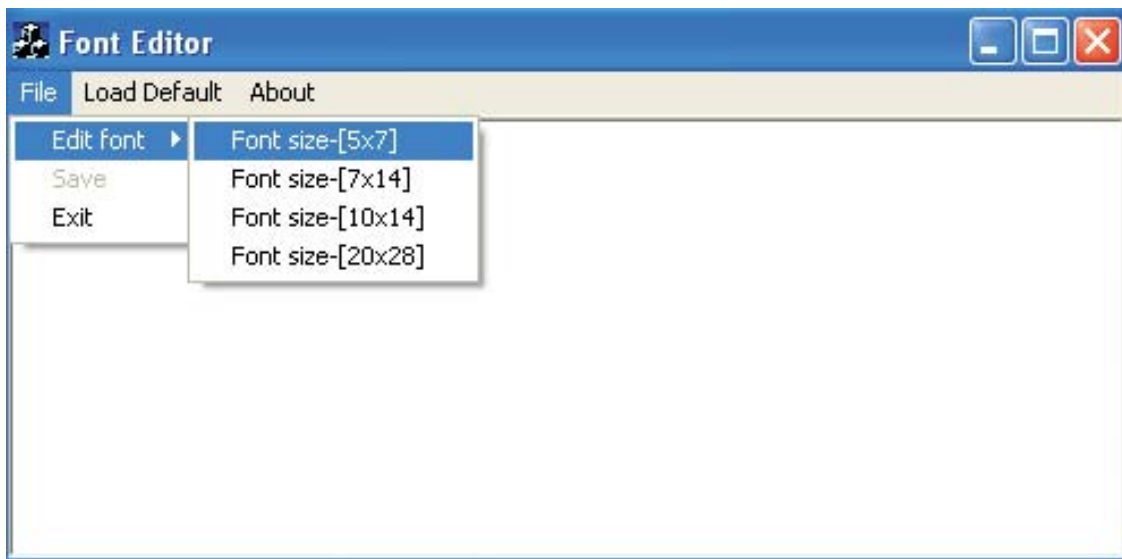

Now select the fonts from the Edit font menu. The following window will appear. The lower window shows the 256 supported character for the selected font. User can select the characters from this. After selecting that character will come on the maximum zoom level window.





In order to view modified font on NTXS screen fonts must be downloaded to unit. Font download option is located under download options list. After changing the required fonts in the font editor. Now user can place the changed font by using Character Map.

### 11.4 Image Conversion to bmp

This utility helps user to convert the image from any other type of picture format to bmp format 'Image Conversion to bmp' utility is located under Utility menu option.

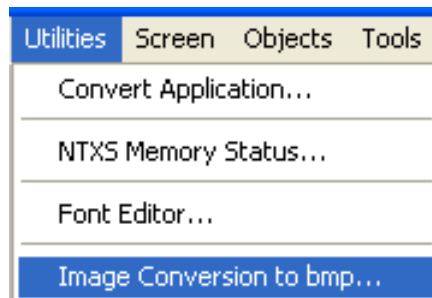

Clicking on this option following screen will be displayed.

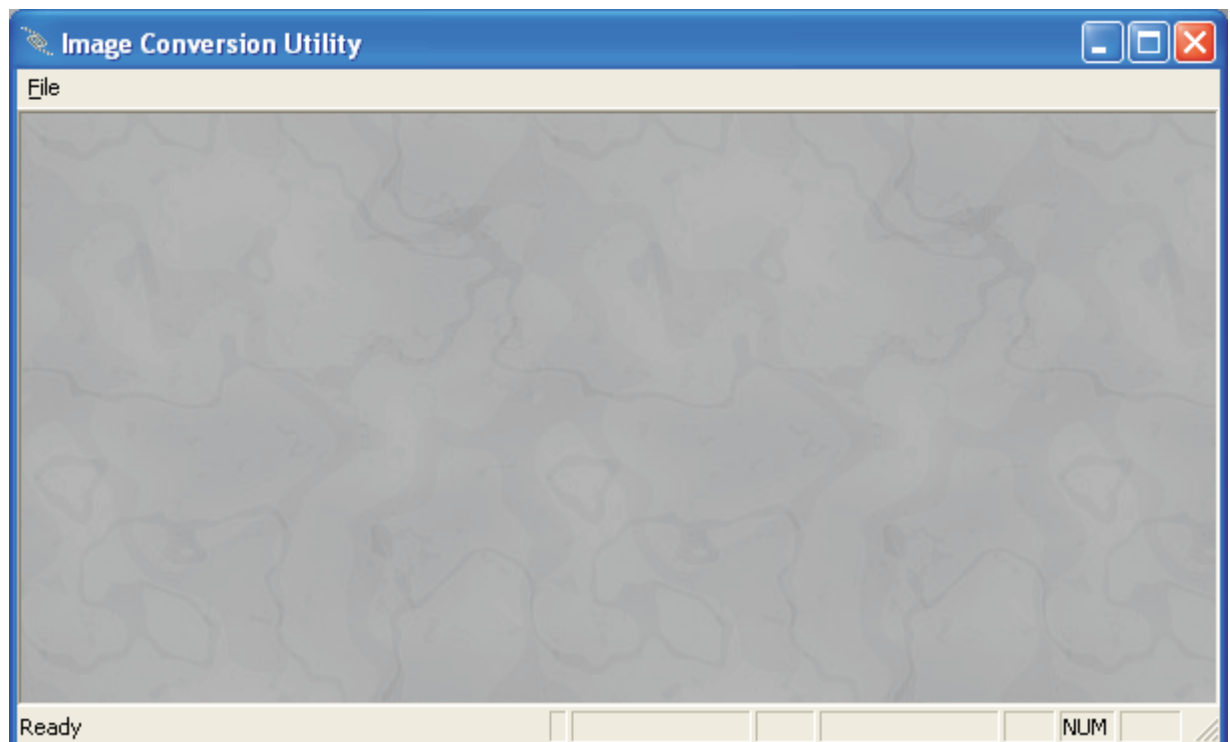

## Miscellaneous

---

This utility support conversion for following types of image formats.

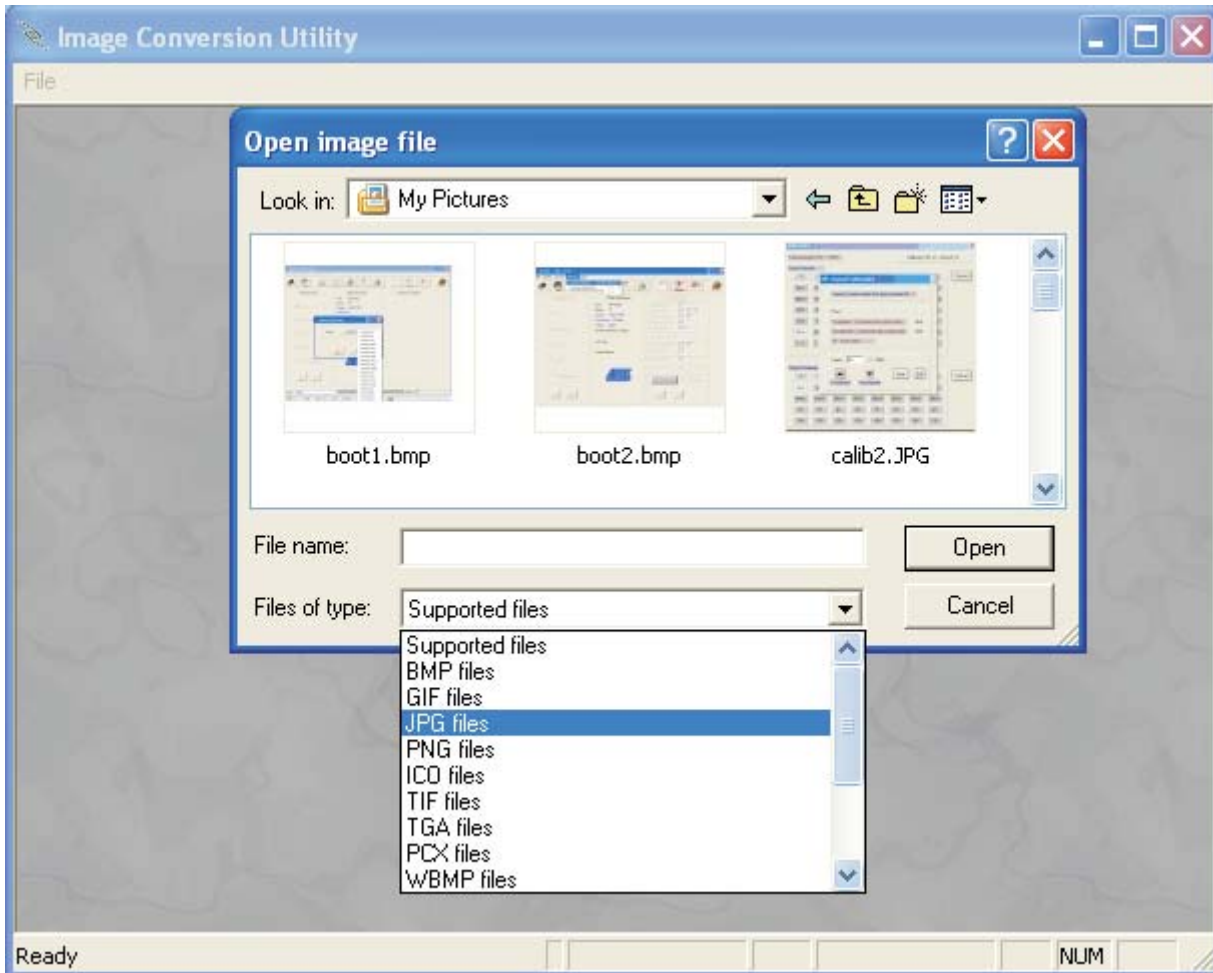

Once image is saved in bmp format user can use Bitmap object for adding image to picture library .

**DIAGNOSTICS & MAINTENANCE**

In this chapter. . . .

- ◆ Diagnostics
- ◆ Maintenance

## Diagnostic and Maintenance

---

### 12.1 Diagnostics

#### 12.1.1 Erase Keys

##### 1. Erase keys for Touch Screen NTXS Models:

In some cases it may be necessary to erase firmware and/or application. Procedures for erasing firmware and application is given below:

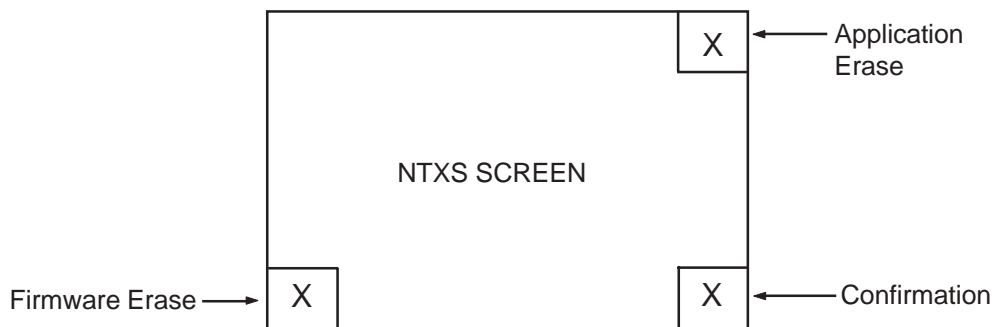

Application erase procedure for NT3S is as follows:

1. At power ON, press the top right corner of the NT3S screen for 2 seconds.
2. Following message is displayed:  
**"Erase Application?? Press Bottom Right corner to confirm.."**
3. Now Press Bottom right corner to confirm Application erase.
4. After application erase is complete following message is displayed:  
**"No setup loaded. Download Application."**

Firmware erase procedure for NT3S is as follows:

1. At power ON, press the bottom left corner of the NT3S screen for 2 seconds.
2. Following message is displayed:  
**"Erase Firmware?? Press Bottom Right corner to confirm.."**
3. Now Press Bottom right corner to confirm Firmware erase.
4. After firmware erase is complete following message is displayed:  
**"NT3S-STxxxB-E Boot Version No firmware. Download Firmware.."**

If unit stops functioning totally please follow steps given below to recover the unit:

- Erase application.
- Download a demo application. If unit functions properly, maybe the application previously downloaded was wrong.
- If unit still fails to function properly, erase firmware. Download firmware and application again.

### 2 Erase Keys for Keypad based NTXS Units:

For NT2S units, user can erase only Application. Firmware can not be erased.

NT2S-SF121B-EV2	Application	At Power On: Press 'F1' and 'F6' Keys simultaneously.
NT2S-SF122B-EV2	Application	At Power On: Press 'F1' and 'F6' Keys simultaneously.
NT2S-SF125B-E	Application	At Power On: Press 'F4' and 'ENT'.
NT2S-SF126B-E	Application	At Power On: Press 'F4' and 'ENT'

#### 12.1.2 Touchscreen Calibration Loss

Touch screens are factory calibrated. Calibration is stored in a Flash memory. If user faces any of the following problems:

- Any press inside defined object boundary results in three short beeps.
- Undefined area performs a task of some other defined object.

User will have to calibrate the touch screen of the unit. Steps for calibrating the touch screen for NT3S models are as below:

1. At power ON, press the center of the NT3S screen for more than 2 to 3 seconds.
2. A cross is shown at the bottom left corner. This cross remains on the screen for approximately 6 seconds. If center of the cross is not pressed in this time, NT3S resumes normal operation. Touch the center of the cross with a pointed object (stylus recommended).
3. You will get a next screen showing a cross at the top right of the screen. Again this cross remains on the screen for approximately 6 seconds. If center of the cross is not pressed in this time, NT3S resumes normal operation. Touch the center of the cross with a pointed object (stylus recommended). The screen has now been calibrated.
4. Unit will be restarted. Normal function of the NT3S can now resume.

## Diagnostic and Maintenance

---

### 12.2 Maintenance

- 12.2.1 Clean all sides of the unit using a isopropyl alcohol solution. Use a clean, soft piece of cloth. Do not use a rough cloth as it may produce scratches on the unit. Take proper care while cleaning the keypad of the unit, especially the LCD window. Also take care that the LCD window does not come in contact with the material that has an abrasive surface.
- 12.2.2. Do not use benzene, paint thinner or other volatile solvents. Do not use any chemically treated cloth, wipes, or rags.
- 12.2.3. Tighten the mounting brackets evenly. Make sure the panel is not dirty or warped and that it is strong enough to hold the unit.
- 12.2.4. Please note keys on the keypad are only for finger operation. They should not be pressed with pointed tools or any other such items. This will cause key failure or other malfunctioning may occur. Do not apply a force any greater that 30 Newton's to the keys.
- 12.2.5. Always tighten the connector screws after connecting the communication cables.
- 12.2.6. The maximum pull load for cables is 30 Newton's. Do not apply loads greater than this.
- 12.2.7 Do not use sharp objects for pressing any touch screen key.

## **APPENDIX**

In this chapter. . . .

- ◆ Omron Cable References and Diagrams
- ◆ Non-Omron Cable Diagrams
- ◆ List of features
- ◆ List of Supported Devices
- ◆ Technical Support

## Appendix

### A Omron Cable References and Diagrams

#### 1 Omron Cable References for connection to PLC's peripheral ports (CMOS)

NTXS Type	Cable Type	PLC Type	Note
NT2S-SF121B-EV2	NT2S-CN212-V1 (5 Meter) with NT2S-CN215-V1 (5 Meter) (Peripheral connector)	CPM1A	Units are externally powered 24 VDC.
NT2S-SF125B-E		CPM2A CQM1	
NT3S-ST121B-E NT3S-ST123B-E NT3S-ST124B-E NT3S-ST126B-E	NT2S-CN223-V2 (2 Meter) (Mini-peripheral connector)	CPM2C CQM1H CJ1 CS1	
NT2S-SF122B-EV2 NT2S-SF123B-EV2 NT2S-SF126B-E	NT2S-CN222-V1 (2 Meter) NT2S-CN225-V1 (5 Meter) (Peripheral Connector)	CPM1A CPM2A CQM1	Units are powered from PLC's peripheral port.
NT2S-SF127B-E	NT2S-CN224-V1 (2 Meter) (Mini-peripheral connector)	CPM2C CQM1H CJ1 CS1	

#### 2 Omron Cable References for connection to PLC's serial ports (RS232C)

NTXS Type	Cable Type	PLC Type	Note	
NT2S-SF121B-EV2	NT2S-CN232-V1 (2 Meter) with NT2S-CN235-V1 (5 Meter) (9psubD to 9psubD)	CP1H	Units are externally powered 24 VDC.	
NT2S-SF125B-E		CPM2A CQM1(H) CJ1 CS1		
NT3S-ST121B-E NT3S-ST123B-E NT3S-ST124B-E NT3S-ST126B-E				
NT2S-SF122B-EV2 NT2S-SF126B-E		CP1H CPM2A CQM1(H) CJ1 CS1		Units are powered from the PLC's serial port.

#### 3 Omron Cable References for Programming cable (PC to NTXS)

NTXS Type	Cable Type	PLC Type	Note
NT2S-All NT3S-All	NT2S-CN002 (2 Meter) (9psubD to 9psubD)	-	-



4 Omron Cable Diagrams for Serial cables

4.1 NT2S-CN232-V1 / NT2S-CN235-V1

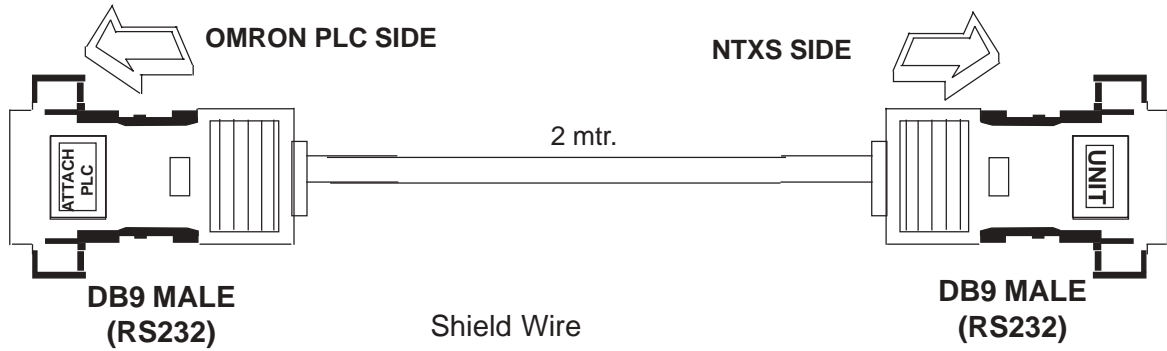

SIGNALS	Pin #
	1
TXD	2
RXD	3
RTS	4
CTS	5
	6
	7
	8
SG	9

Shield Wire

Pin #	SIGNALS
1	
2	TXD
3	RXD
4	
5	SG
6	
7	
8	
9	

Shield Wire to DB9 Body

Shield Wire

DB9 MALE PINOUTS

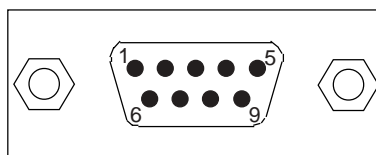

# Appendix

## 4.2 NT2S-CN242-V1

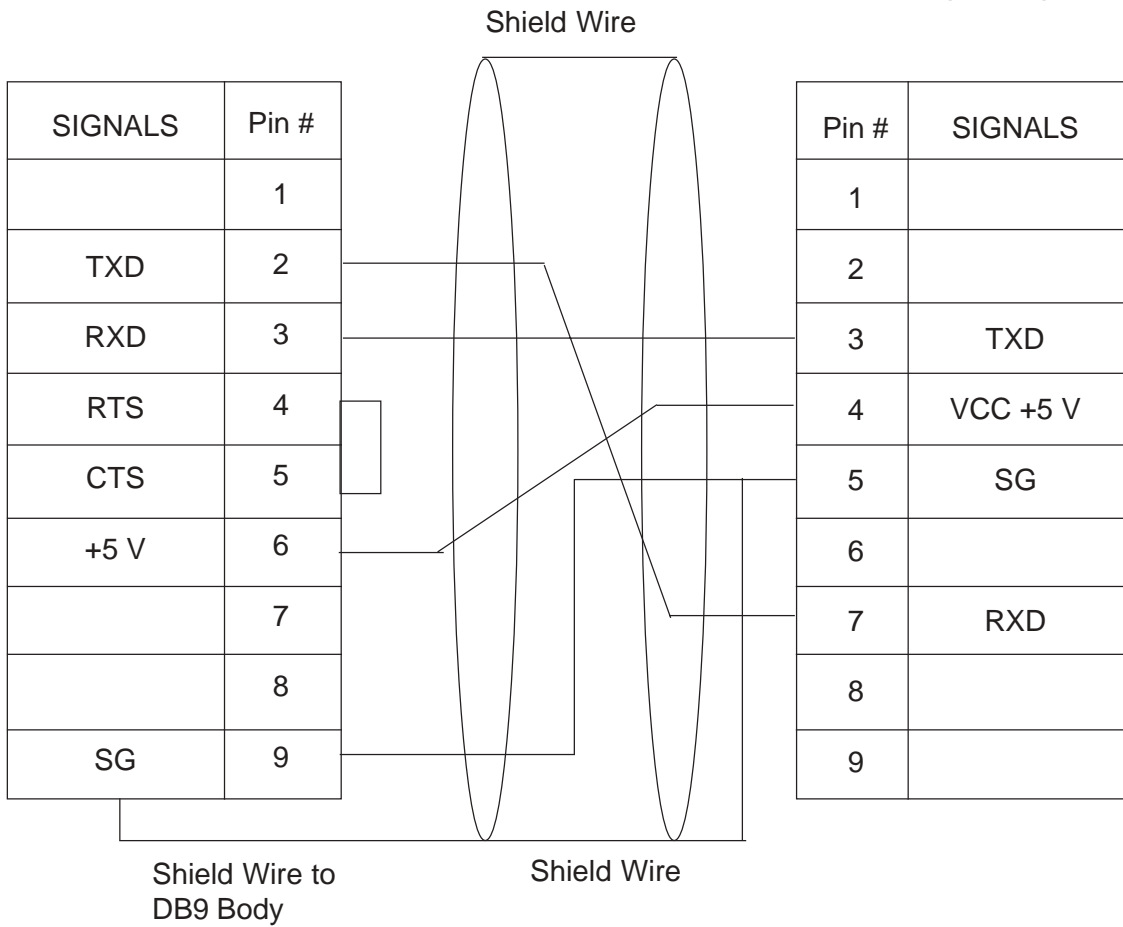
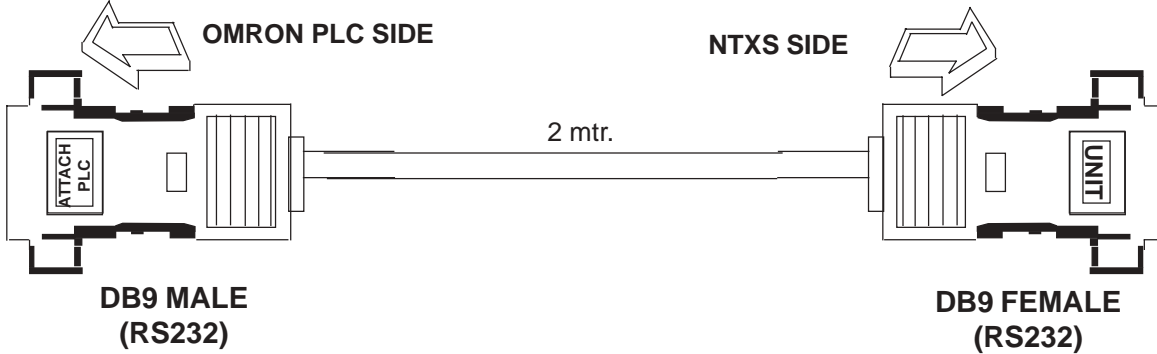

**DB9 MALE PINOUTS**

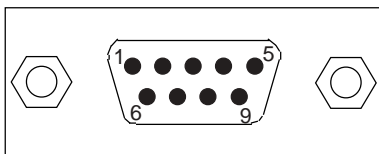

**DB9 FEMALE PINOUTS**

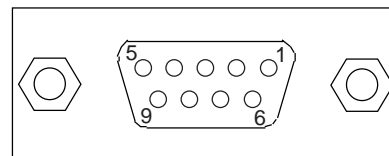

5 Omron Cable Diagram for NT2S / NT3S Programming cable

5.1 NT2S-CN002

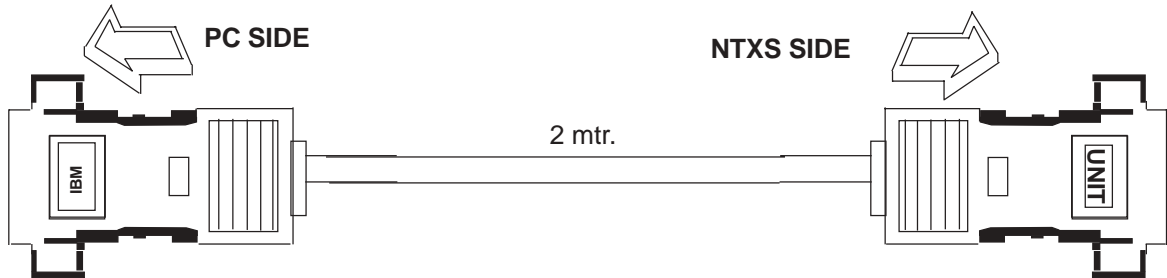

**DB9 FEMALE  
(RS232)**

Shield Wire

**DB9 MALE  
(RS232)**

SIGNALS	Pin #
	1
RXD	2
TXD	3
	4
SG	5
	6
	7
	8
	9

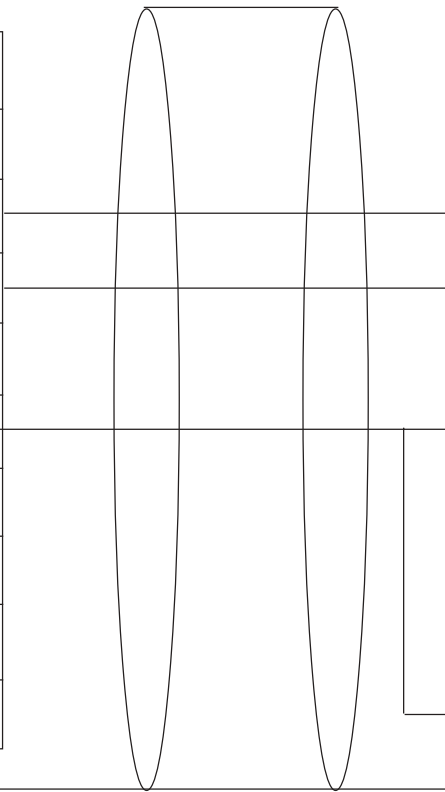

Pin #	SIGNALS
1	
2	TXD
3	RXD
4	
5	SG
6	
7	
8	
9	

Shield Wire to DB9 Body on Both sides

**DB9 FEMALE  
PINOUTS**

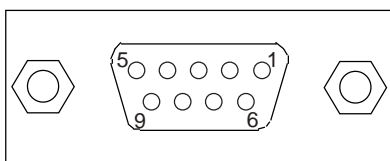

**DB9 MALE  
PINOUTS**

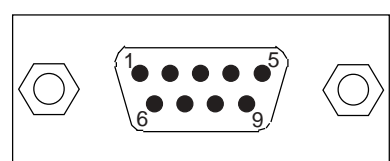

# Appendix

## 6 Omron Cable Diagram for RS422 Communication cable XtraDrive and NT3S

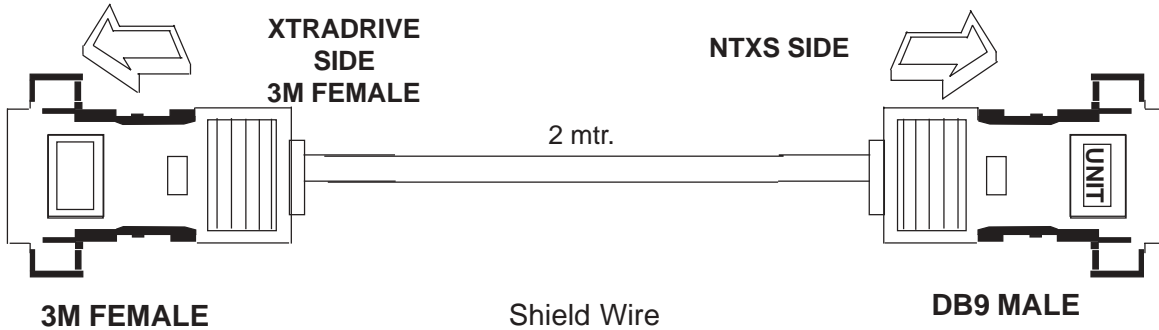

**3M FEMALE**

Shield Wire

**DB9 MALE**

SIGNALS	Pin #
TXD	1
/TXD	2
RXD	3
/RXD	4
	5
/RXD	6
RT	7
	8
	9
	10
	11
	12
	13
GND FG case	14

Pin #	SIGNALS
1	TX+
2	
3	
4	RX+
5	GND
6	
7	
8	TX-
9	RX-

**XTRADrive  
3M FEMALE  
PINOUTS**

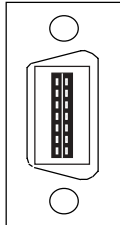

**DB9 MALE  
PINOUTS**

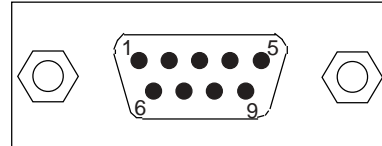

XtraDrive Connectro Type (3M)  
10114-3000VE (Connector)  
10314-52A0-008 (Cover)

Omron Order code for XtraDrive connector is R7A-CNA01R

**B Non-Omron Cable Diagrams**

**1 AB MICROLOGIX SERIES TO NTXS UNIT**

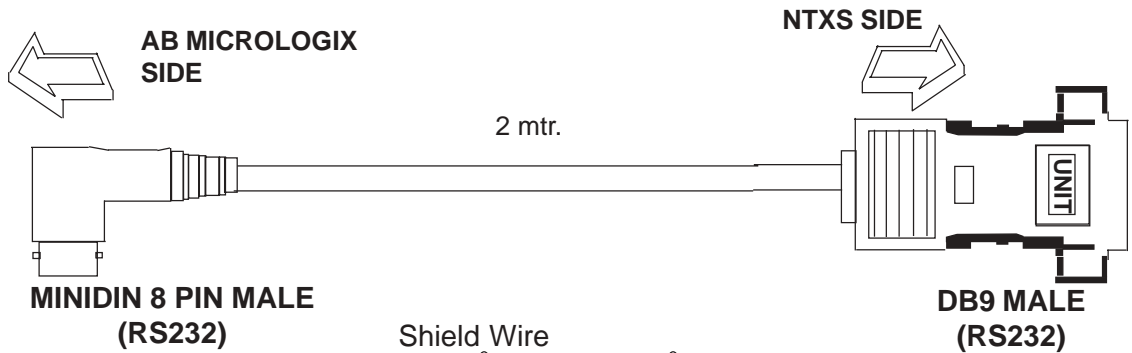

SIGNALS	Pin #
	1
SG	2
	3
RXD	4
	5
	6
TXD	7
	8

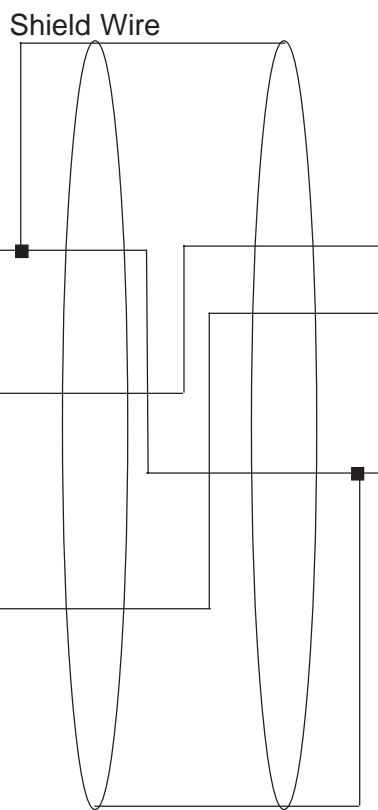

Pin #	SIGNALS
1	
2	TXD
3	RXD
4	
5	SG
6	
7	
8	
9	

**8 PIN MINIDIN CONNECTOR PINOUTS**

**DB9 MALE PINOUTS**

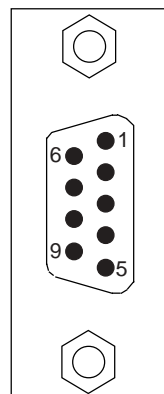
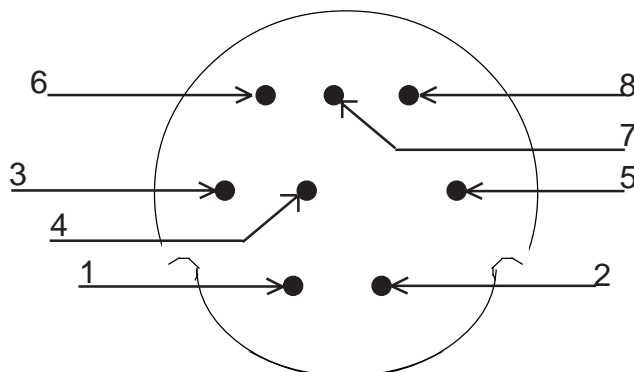

# Appendix

## 2 AB SLC DF1 PORT TO NTXS UNIT

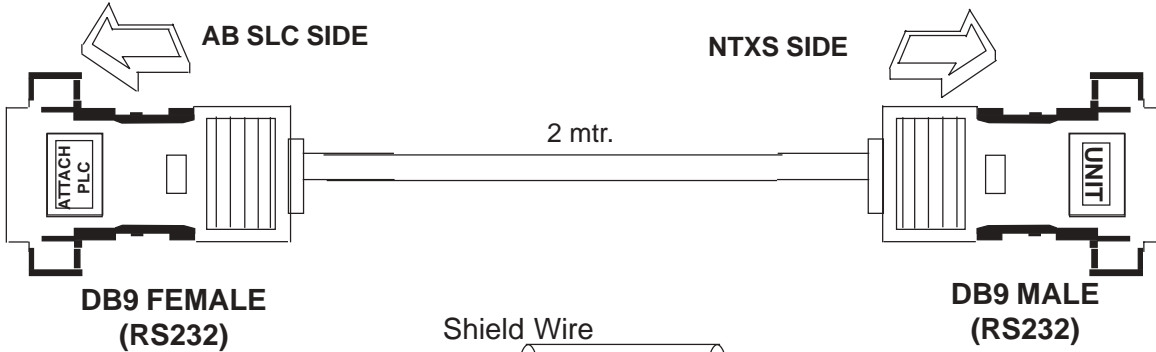

SIGNALS	Pin #
	1
RXD	2
TXD	3
	4
SG	5
	6
	7
	8
	9

Shield Wire

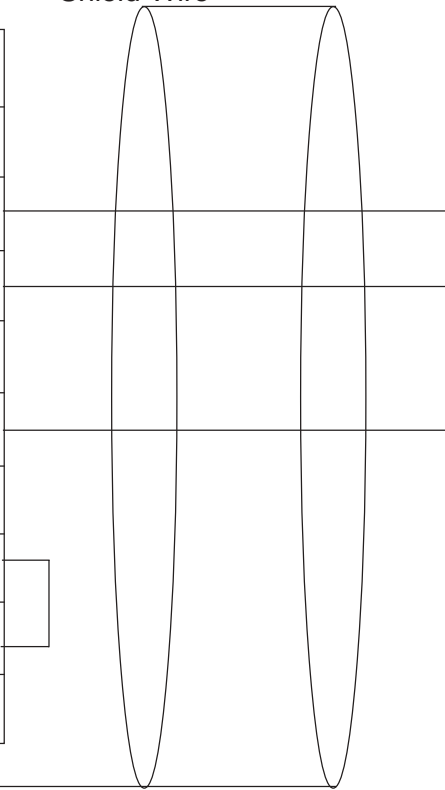

Pin #	SIGNALS
1	
2	TXD
3	RXD
4	
5	SG
6	
7	
8	
9	

**DB9 FEMALE PINOUTS** Shield Wire to DB9 body

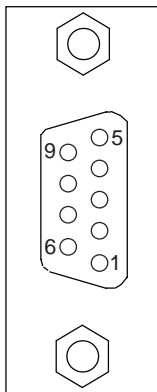

**DB9 MALE PINOUTS**

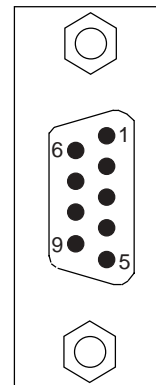

3 AROMAT FP0 / FPM TO NTXS UNIT

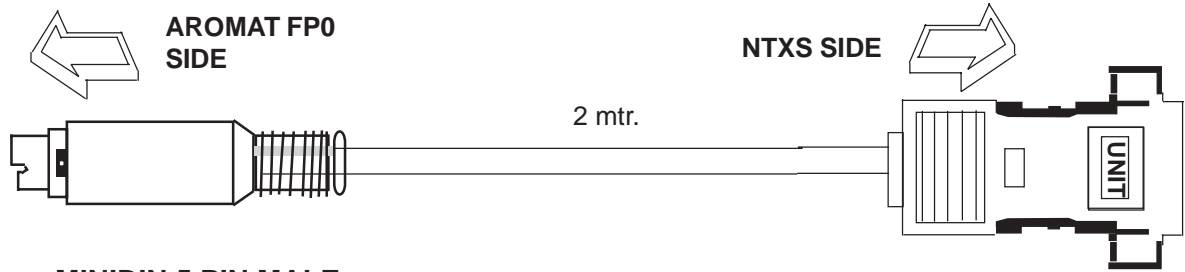

**MINIDIN 5 PIN MALE (RS232)**

SIGNALS	Pin #
SG	1
TXD	2
RXD	3
	4
	5

**DB9 MALE (RS485)**

Pin #	SIGNALS
1	
2	TXD
3	RXD
4	
5	SG
6	
7	
8	
9	

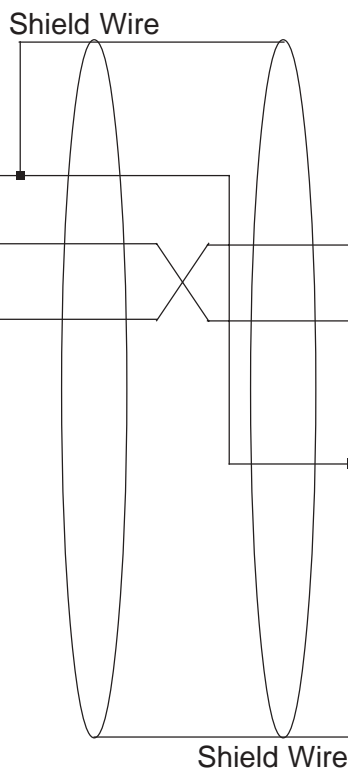

**5 PIN MINIDIN CONNECTOR PINOUTS**

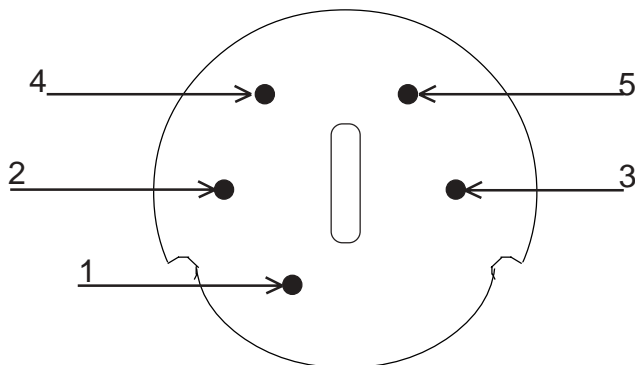

**DB9 MALE PINOUTS**

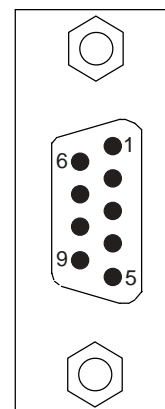

# Appendix

## 4 AROMAT FP1 TO NTXS UNIT

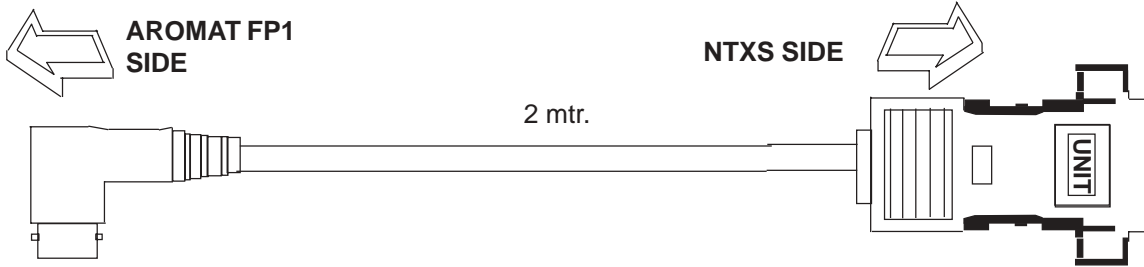

**DIN CONNECTOR MALE (RS485)**

**DB9 MALE (RS485)**

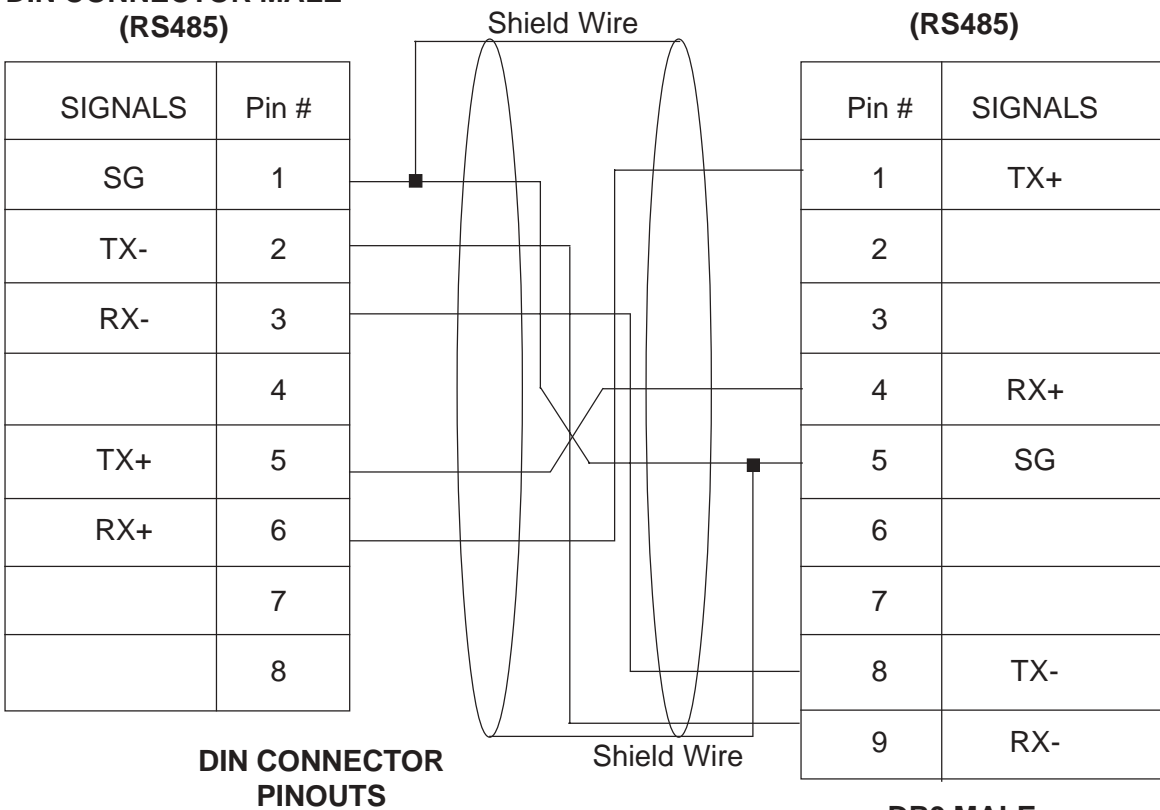

**DIN CONNECTOR PINOUTS**

**DB9 MALE PINOUTS**

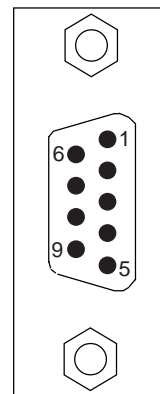
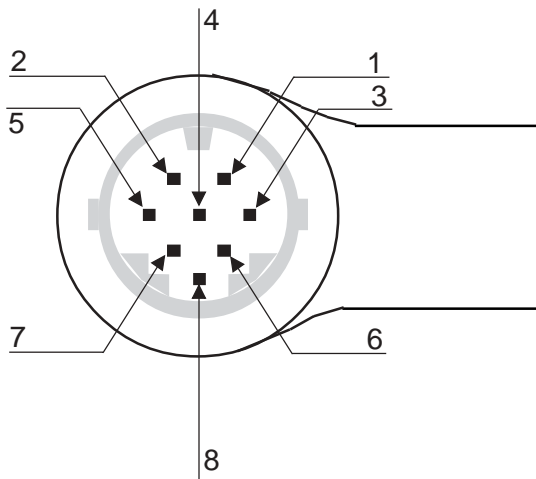



5 AROMAT FP2 TO NTXS UNIT

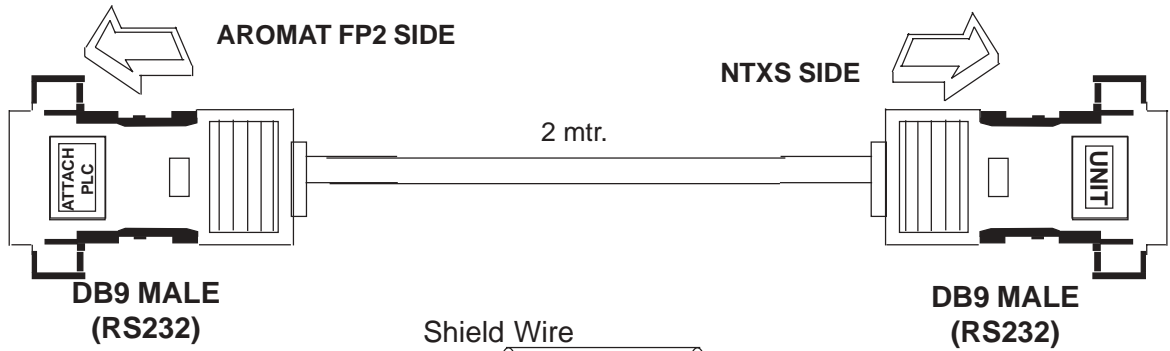

SIGNALS	Pin #
	1
TXD	2
RXD	3
	4
	5
	6
SG	7
	8
	9

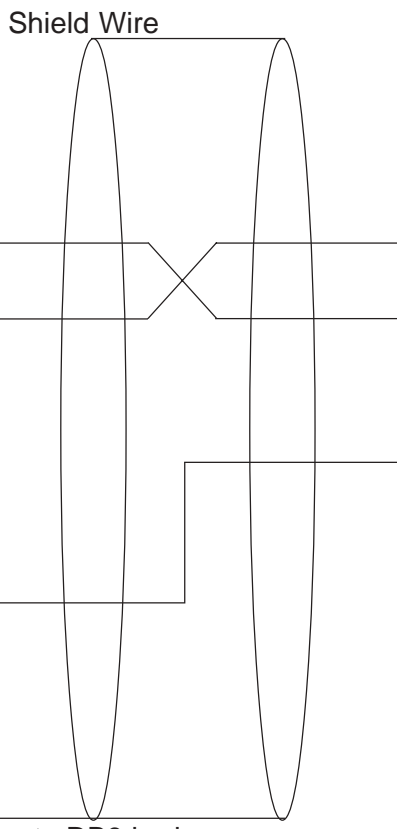

Pin #	SIGNALS
1	
2	TXD
3	RXD
4	
5	SG
6	
7	
8	
9	

Shield Wire to DB9 body

DB9 MALE PINOUTS

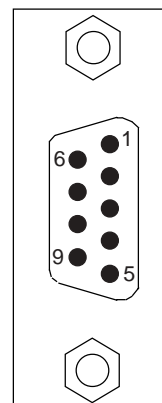

# Appendix

## 6 CONTROL TECHNIQUES TO NTXS UNIT



### 8 PIN MODULAR CONNECTOR (RS422)

SIGNALS	Pin #
	1
A	2
SG	3
	4
	5
	6
B	7
	8

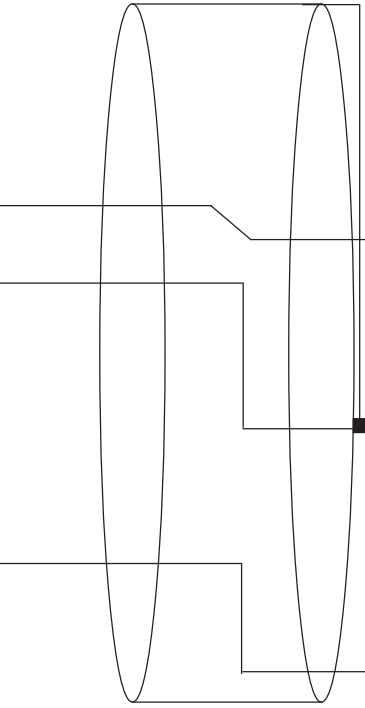

### DB9 MALE (RS422)

Pin #	SIGNALS
1	TX+
2	
3	
4	RX+
5	SG
6	
7	
8	TX-
9	RX-

### 8 PIN MODULAR CONNECTOR PINOUTS

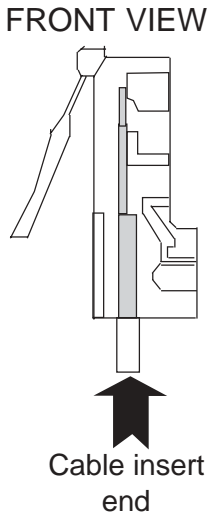

### R.H.S. VIEW

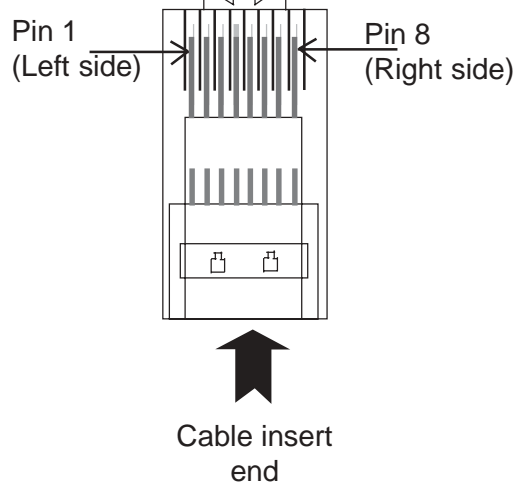

### DB9 MALE PINOUTS

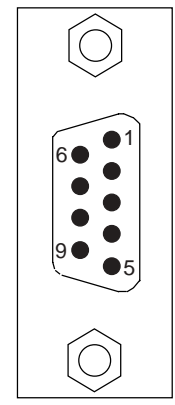

7 DANFOSS DRIVE TO NTXS UNIT

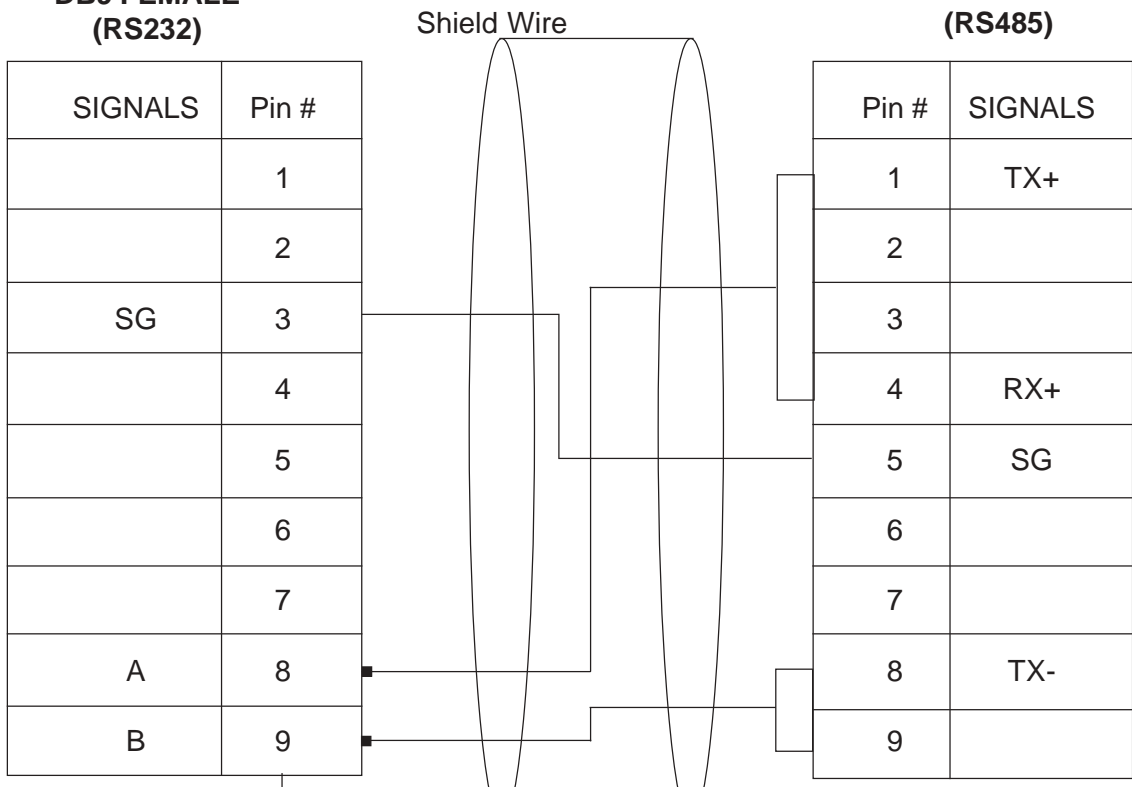
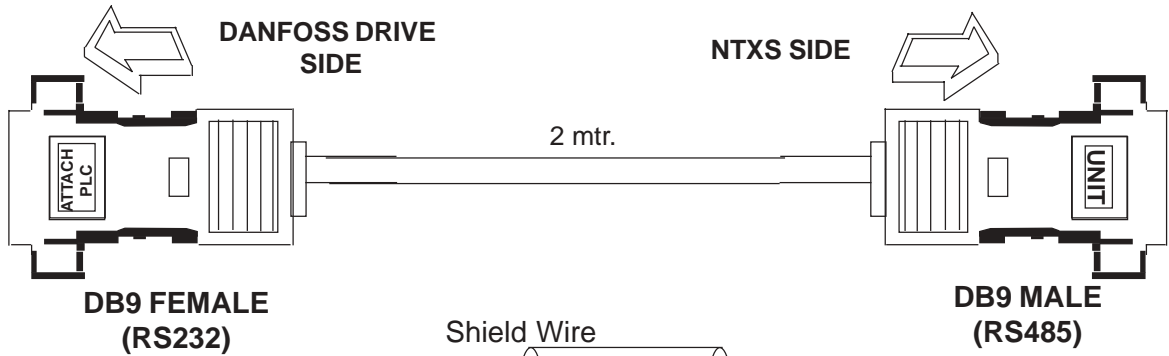

DB9 FEMALE PINOUTS Shield Wire to DB9 body

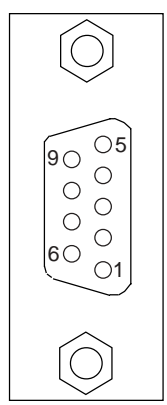

DB9 MALE PINOUTS

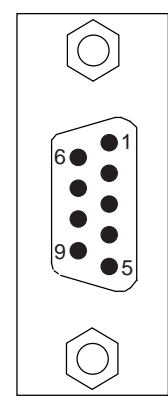

# Appendix

## 8 GE90 SERIES PLC TO NTXS UNIT

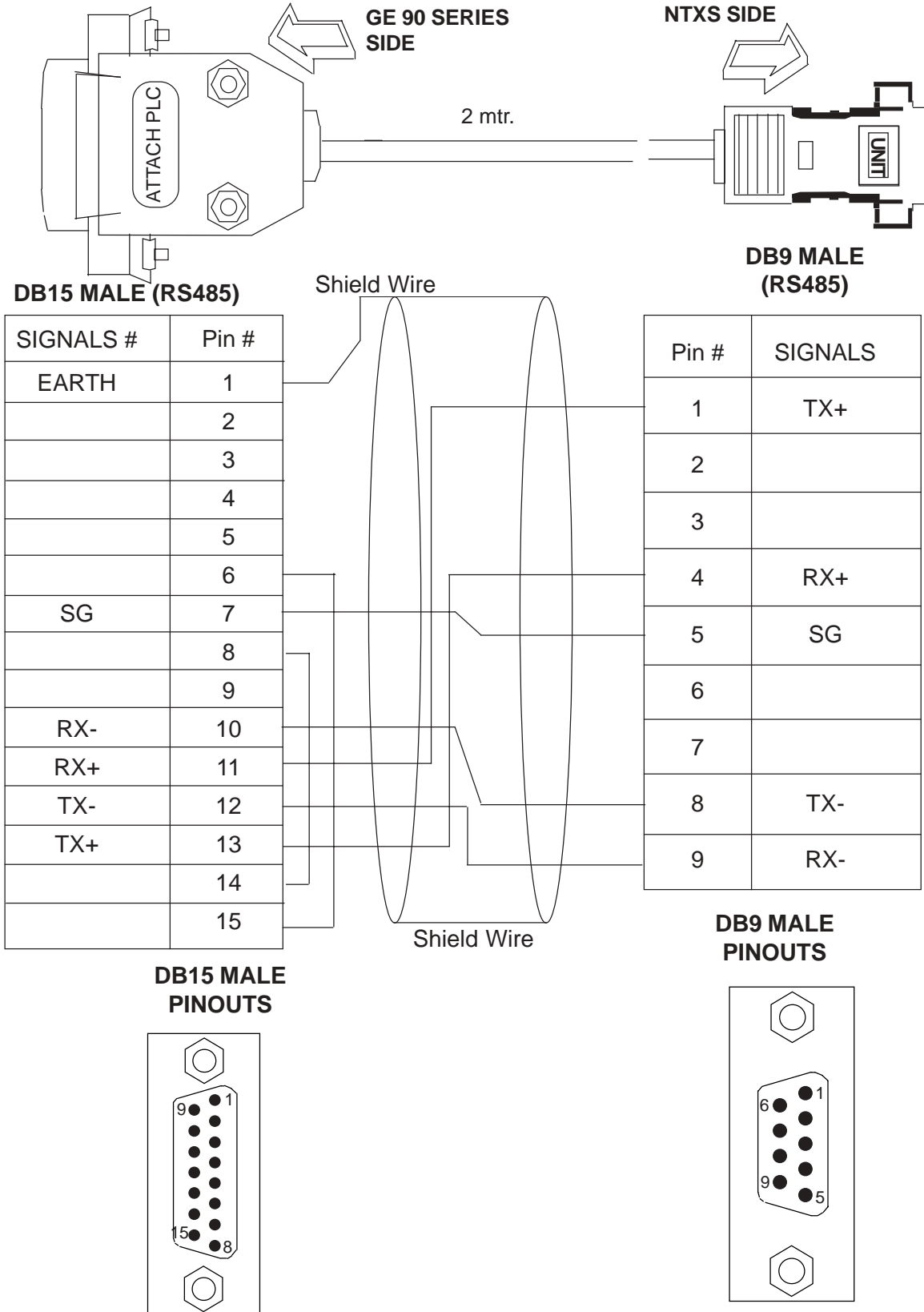

9 GE90 SERIES SNP-X PLC TO NTXS UNIT

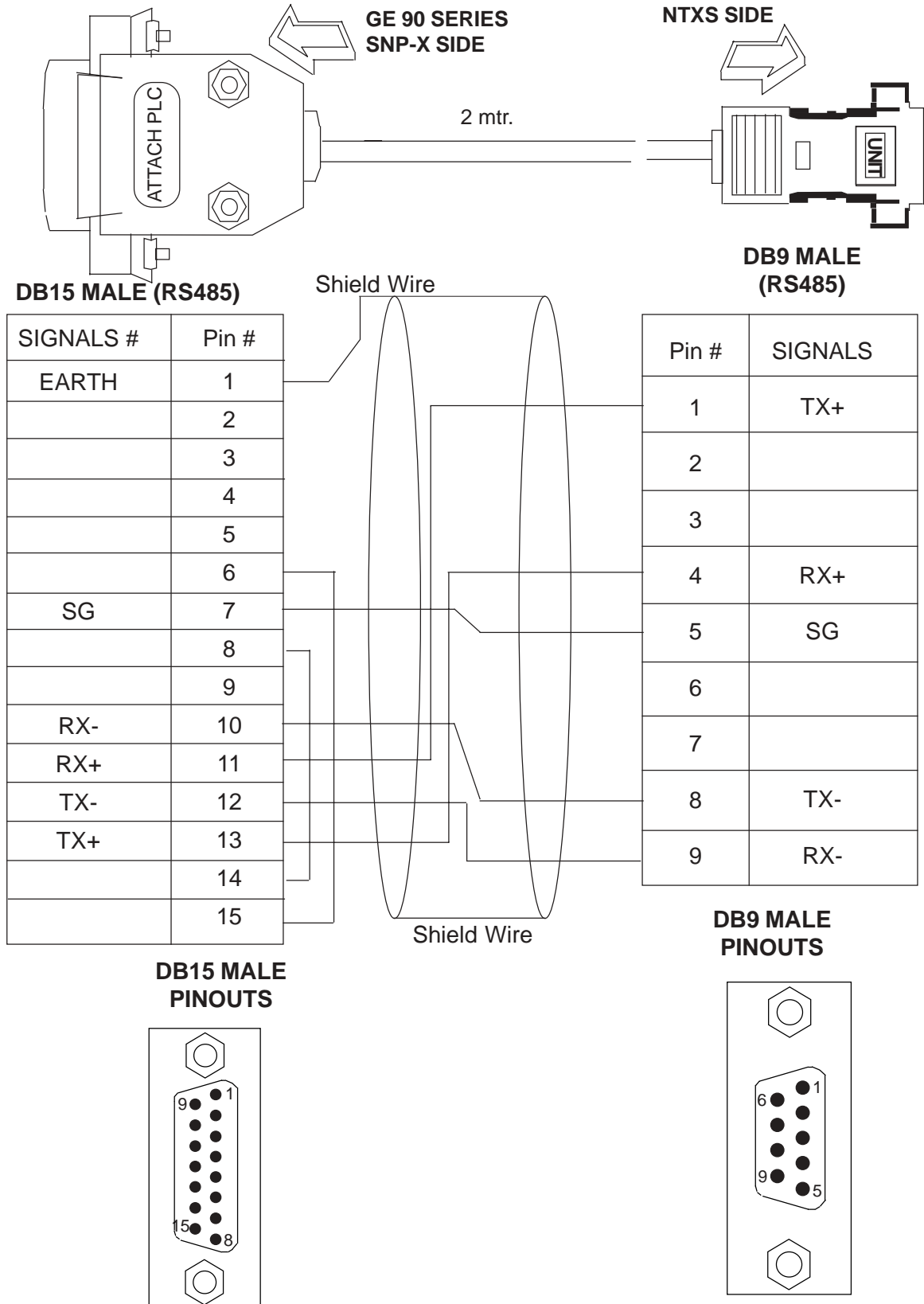

# Appendix

## 10 IDEC MICRO<sup>3</sup> TO NTXS UNIT

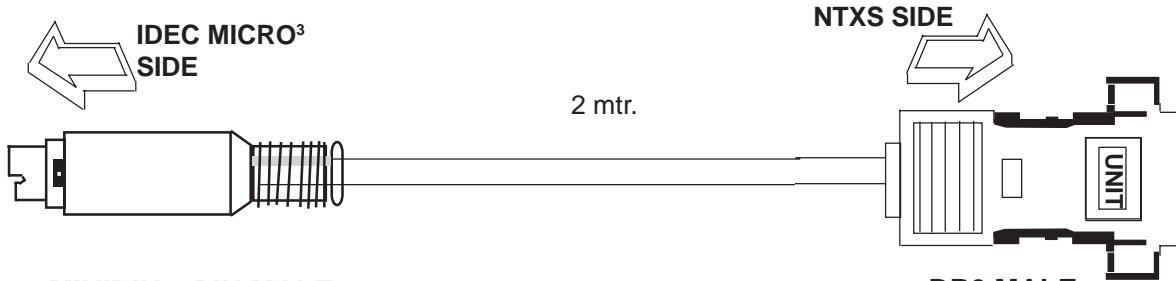

**MINIDIN 8 PIN MALE (RS232)**

SIGNALS	Pin #
A	1
B	2
	3
	4
	5
	6
SG	7
	8

Shield Wire

**DB9 MALE (RS485)**

Pin #	SIGNALS
1	TX+
2	
3	
4	RX+
5	SG
6	
7	
8	TX-
9	RX-

Shield Wire

**8 PIN MINIDIN CONNECTOR PINOUTS**

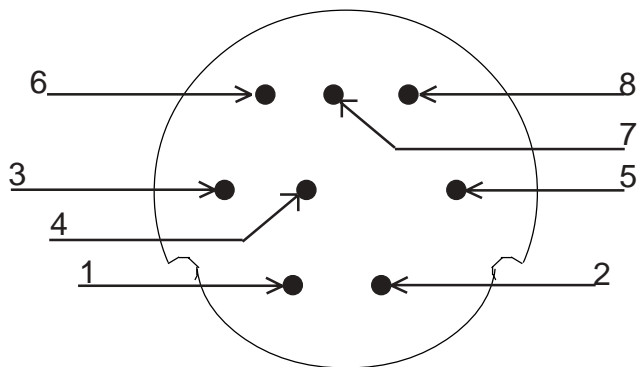

**DB9 MALE PINOUTS**

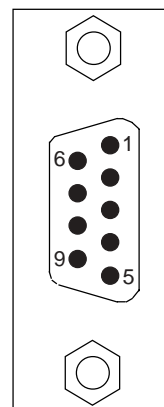

11 IDEC MICROSMART PLC TO NTXS UNIT

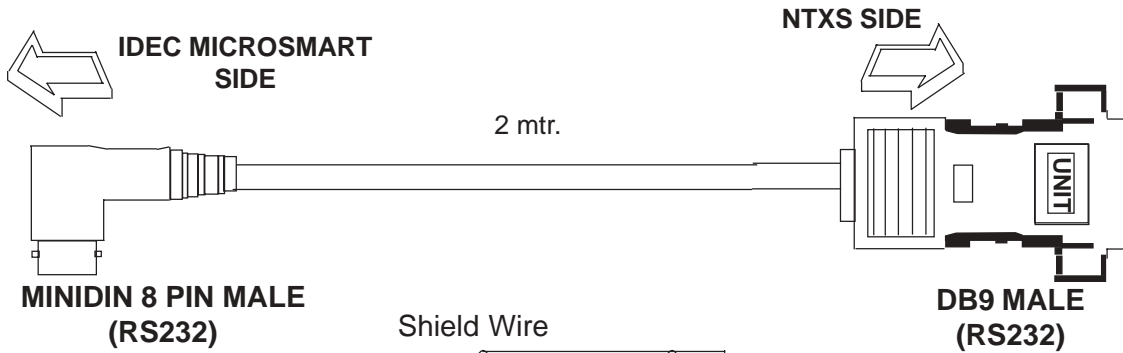

SIGNALS	Pin #
	1
	2
TXD	3
TXD	4
	5
SG	6
SG	7
	8

Shield Wire

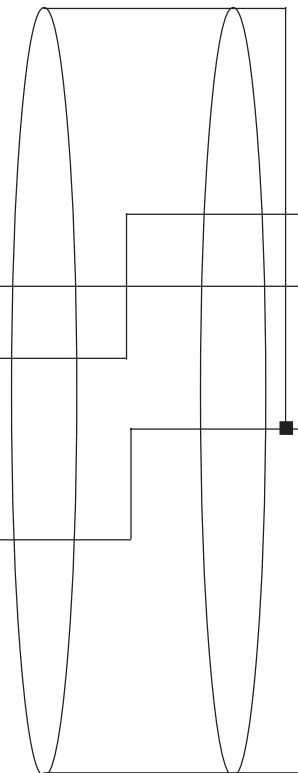

Pin #	SIGNALS
1	
2	TXD
3	RXD
4	
5	SG
6	
7	
8	
9	

8 PIN MINIDIN CONNECTOR PINOUTS

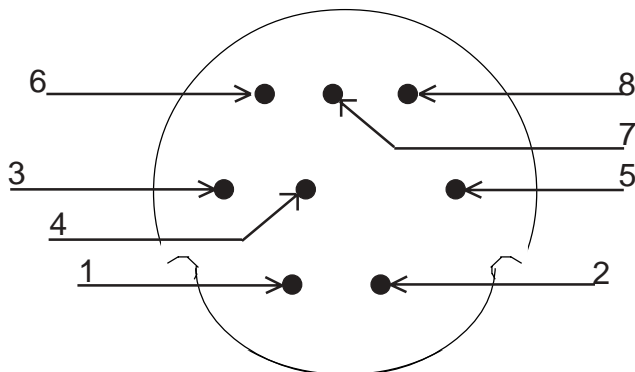

DB9 MALE PINOUTS

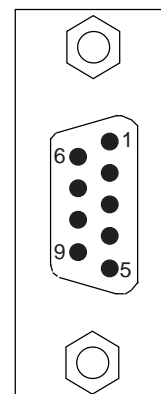

# Appendix

## 12 KEYENCE KV PLC TO NTXS UNIT

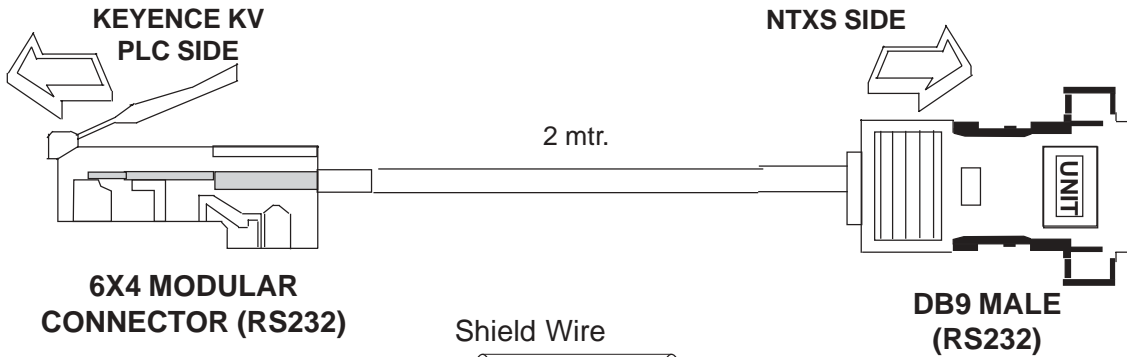

SIGNALS	Pin #
TXD	1
SG	2
RXD	3
	4

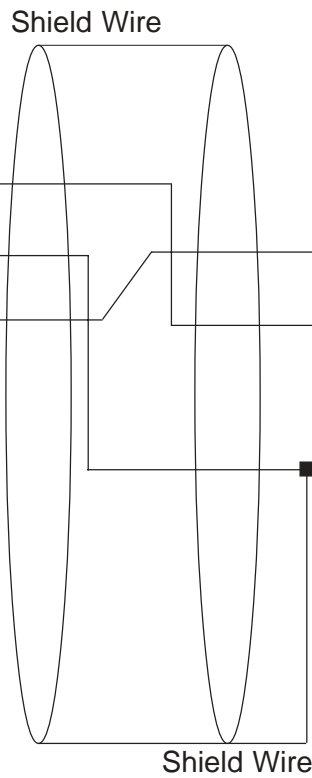

Pin #	SIGNALS
1	
2	TXD
3	RXD
4	
5	SG
6	
7	
8	
9	

### 8 PIN MODULAR CONNECTOR PINOUTS

#### FRONT VIEW

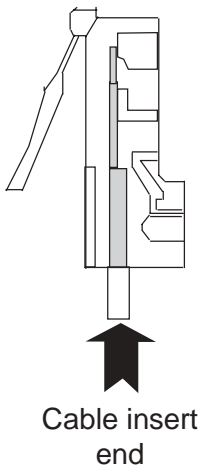

#### R.H.S. VIEW

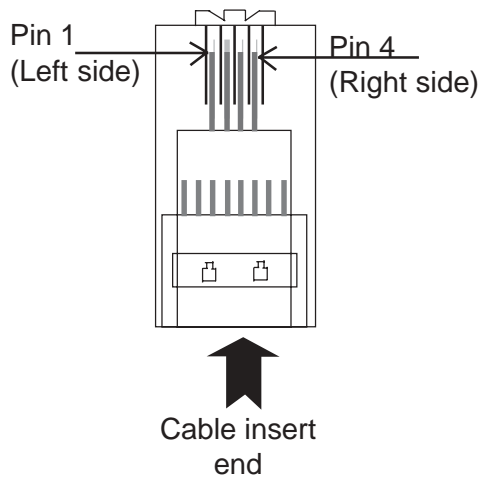

### DB9 MALE PINOUTS

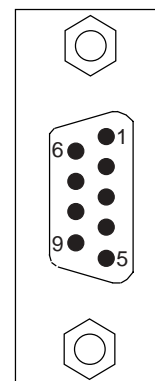



13 KOYO DL205 PLC TO NTXS UNIT

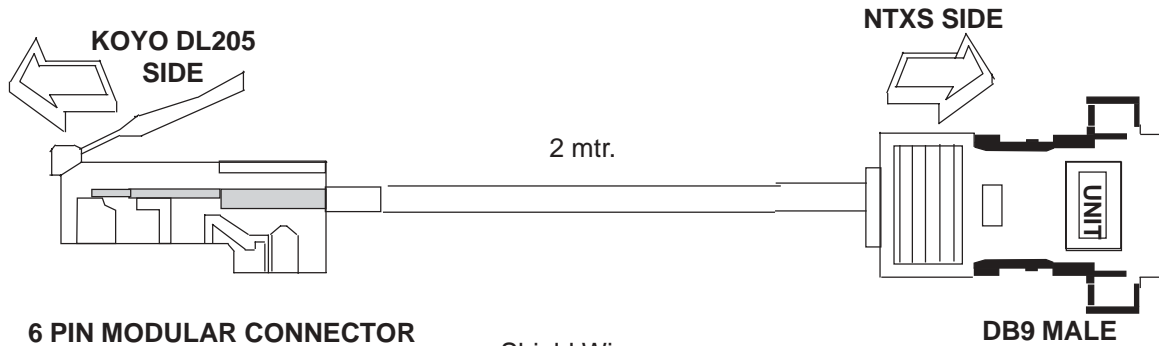

6 PIN MODULAR CONNECTOR

SIGNALS	Pin #
GND	1
	2
TXD	3
RXD	4
	5
	6

Shield Wire

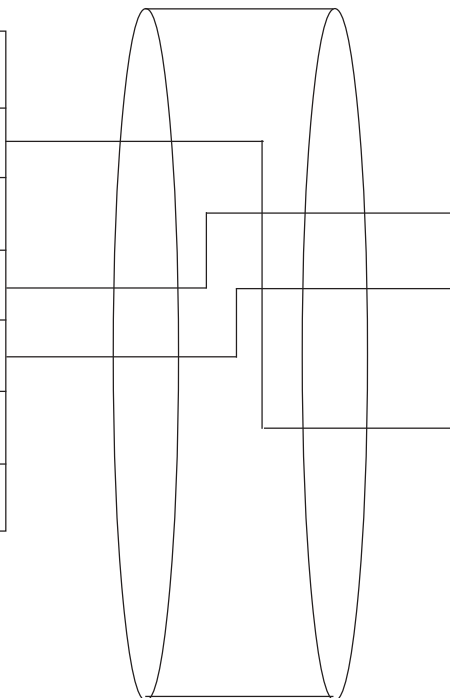

Pin #	SIGNALS
1	
2	TXD
3	RXD
4	
5	SG
6	
7	
8	

6 PIN MODULAR CONNECTOR

Shield Wire

FRONT VIEW

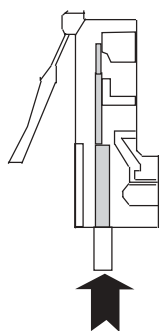

Cable insert

R.H.S. VIEW

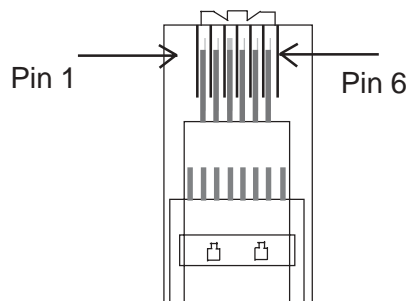

Cable insert

DB9 MALE

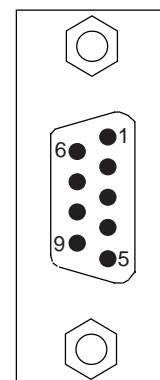

Appendix

14 LG MASTER K SERIES PLC TO NTXS UNIT

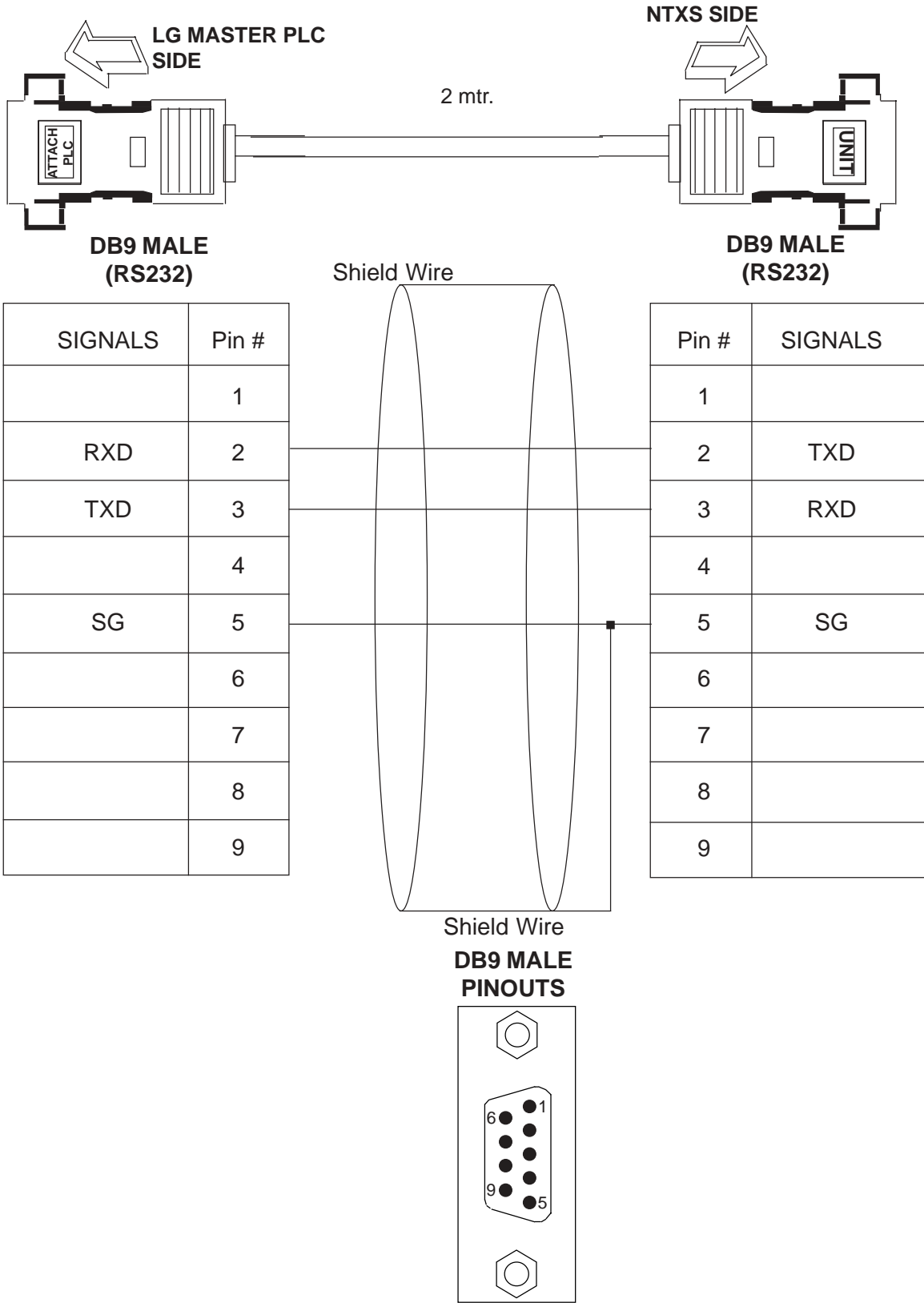

15 MITSUBISHI FX SERIES PLC TO NTXS UNIT

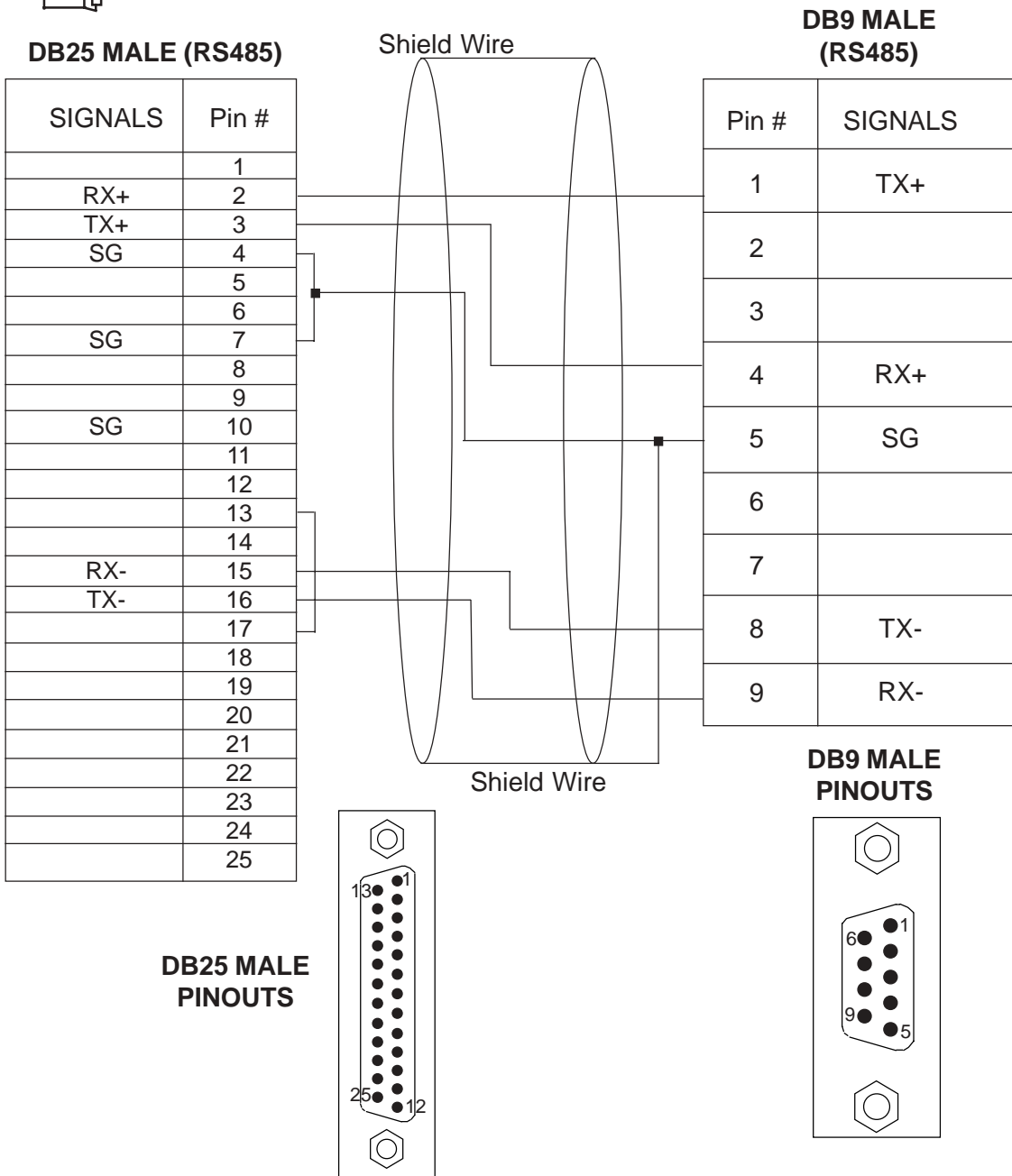
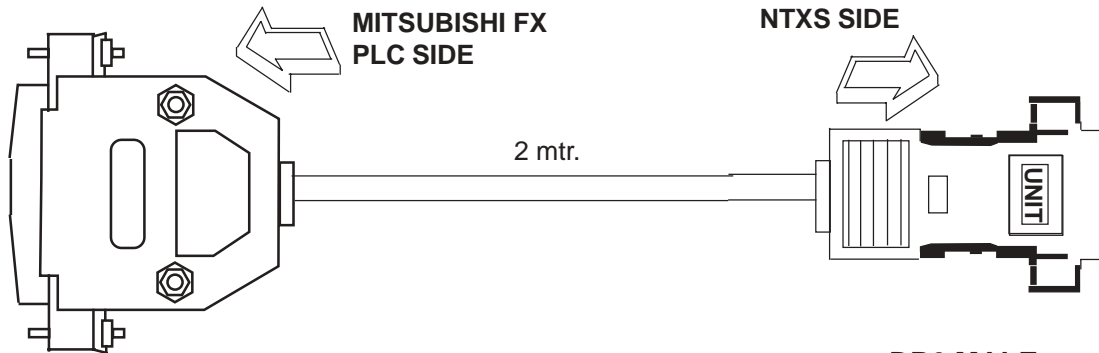

# Appendix

## 16 MITSUBISHI FX0 PLC TO NTXS UNIT

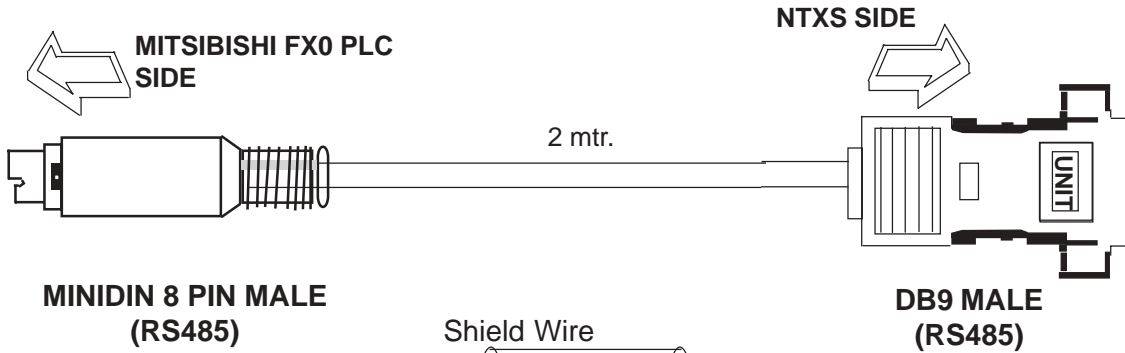

SIGNALS	Pin #
RX-	1
RX+	2
SG	3
TX-	4
	5
	6
TX+	7
	8

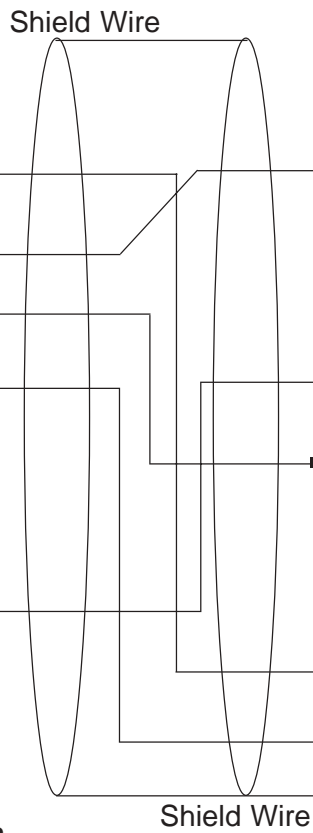

Pin #	SIGNALS
1	TX+
2	
3	
4	RX+
5	SG
6	
7	
8	TX-
9	RX-

8 PIN MINIDIN CONNECTOR PINOUTS

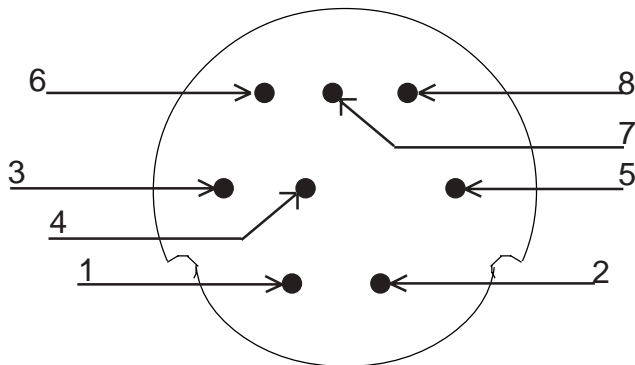

DB9 MALE PINOUTS

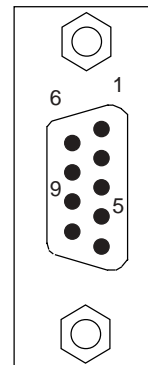

17 SIEMENS STEP 7 MICRO(S7-200) PLC TO NTXS UNIT

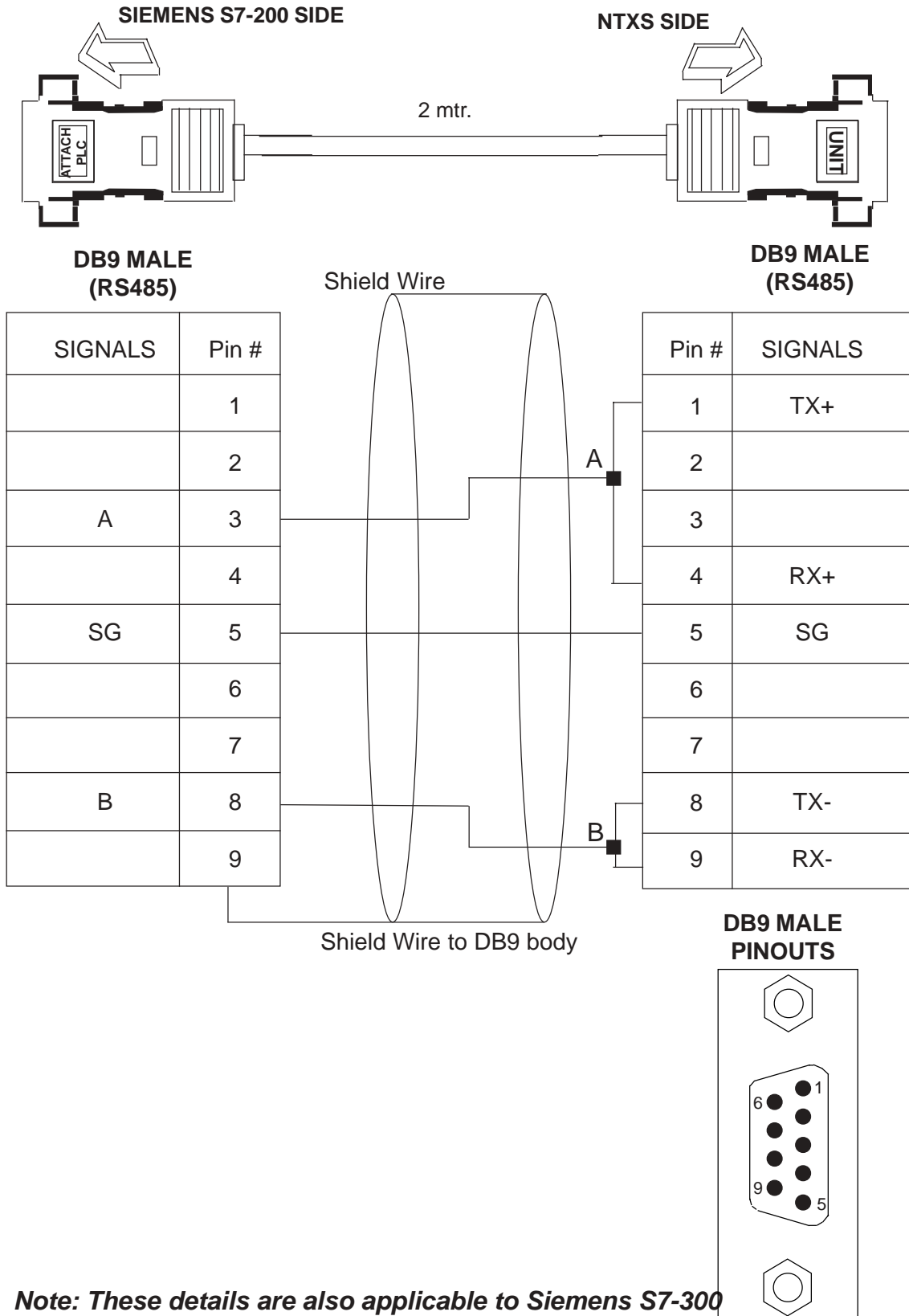

*Note: These details are also applicable to Siemens S7-300*

# Appendix

## 18 SIEMENS-S7 300 SERIES PLC TO NTXS UNIT

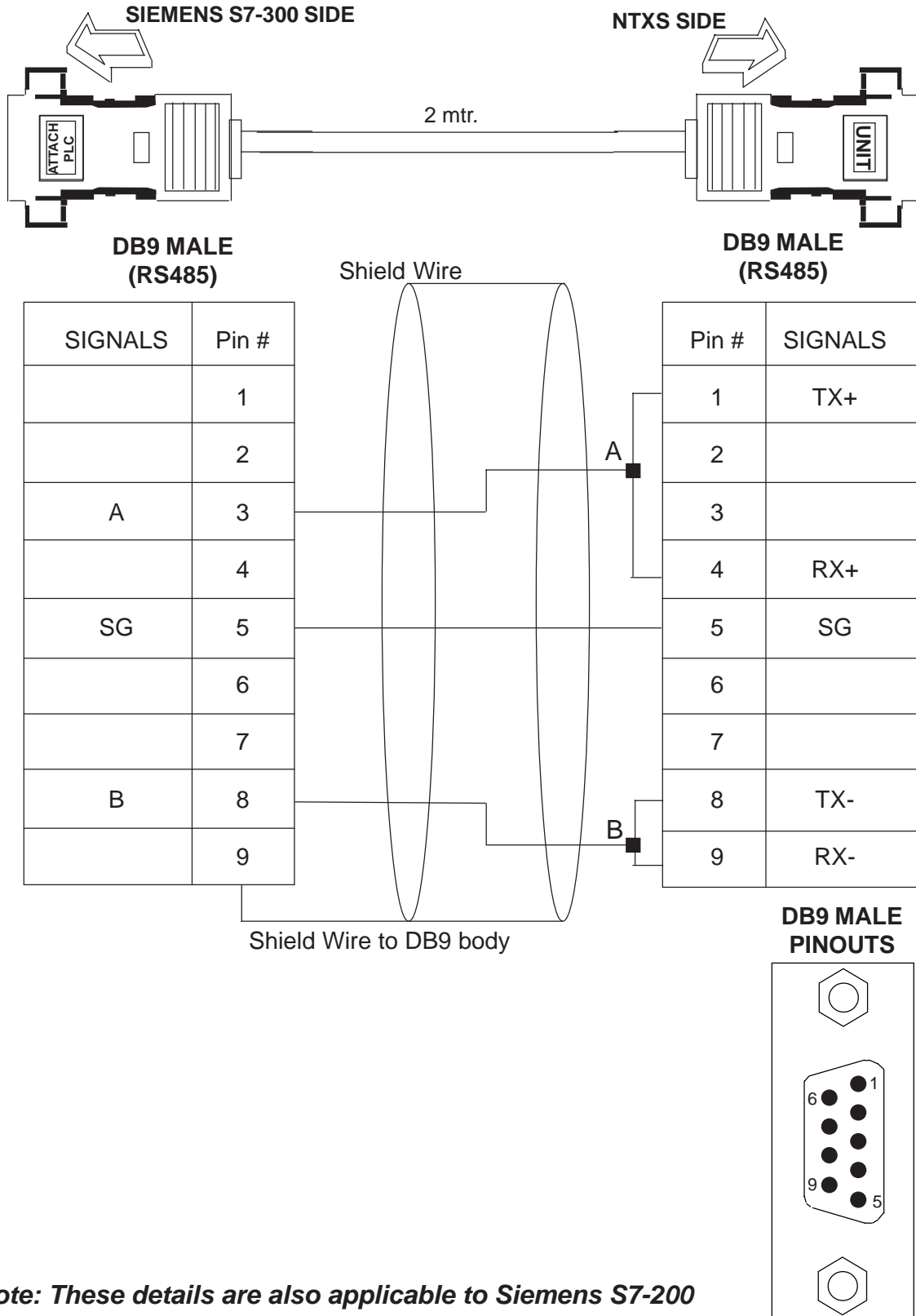

19 TOSHIBA T1 PLC TO NTXS UNIT

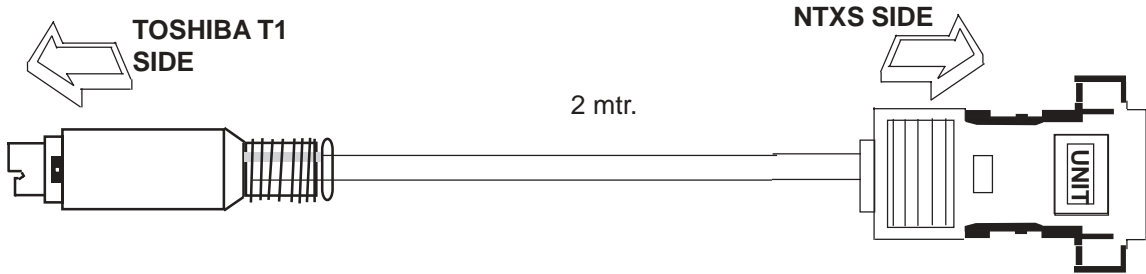

**MINIDIN 8 PIN MALE (RS485)**

SIGNALS	Pin #
	1
	2
	3
	4
SG	5
TXD	6
	7
RXD	8

**DB9 MALE (RS232)**

Pin #	SIGNALS
1	
2	TXD
3	RXD
4	
5	SG
6	
7	
8	
9	

**8 PIN MINIDIN CONNECTOR PINOUTS**

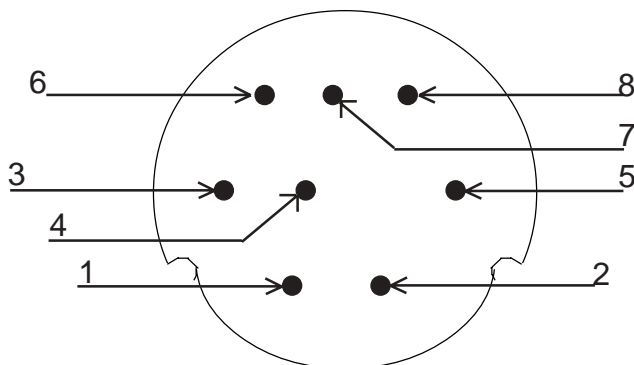

**DB9 MALE PINOUTS**

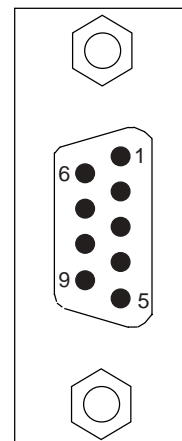

# Appendix

## 20 TOSHIBA T2 PLC TO NTXS UNIT

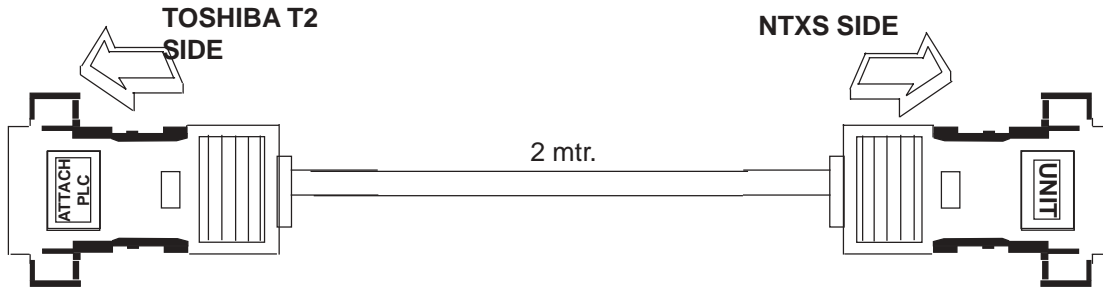

**DB9 MALE (RS232)**

SIGNALS	Pin #
	1
RXD	2
TXD	3
	4
SG	5
	6
	7
	8
	9

Shield Wire

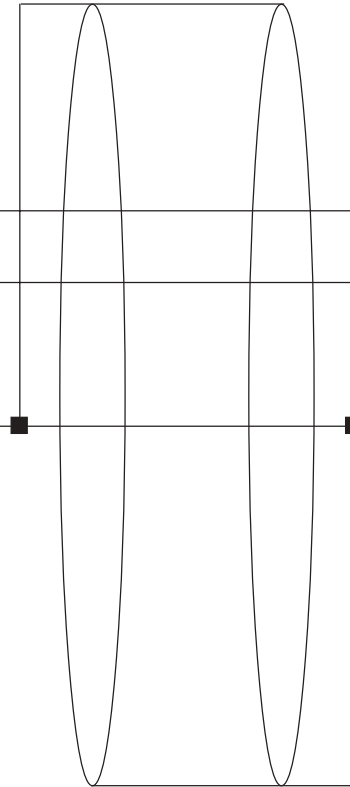

Shield Wire

**DB9 MALE (RS232)**

Pin #	SIGNALS
1	
2	TXD
3	RXD
4	
5	SG
6	
7	
8	
9	

**DB9 MALE PINOUTS**

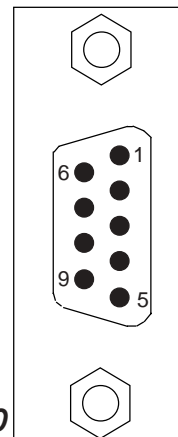

**Note: These details are also applicable to Siemens S7-300**



21 TOSHIBA T1 LINK PORT TO NTXS UNIT

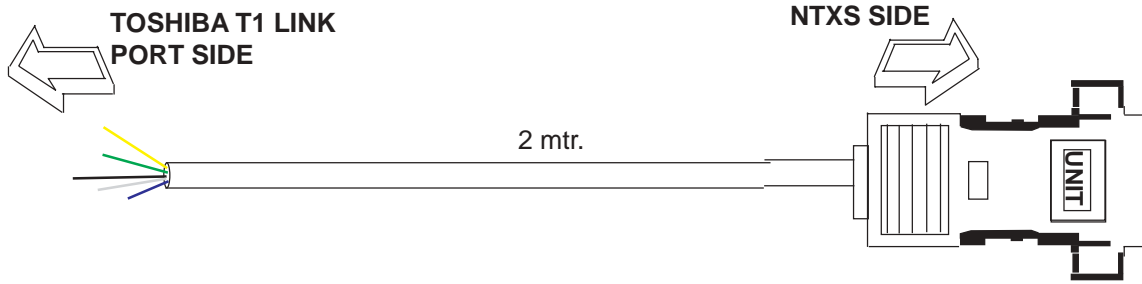

WIRE OUTS  
SIGNAL FROM PLC

SIGNALS	Pin #
RX+	YELLOW
TX+	GREEN
SG	BLACK
RX-	WHITE
TX-	BLUE

Shield Wire

DB9 MALE  
(RS485)

Pin #	SIGNALS
1	TX+
2	
3	
4	RX+
5	SG
6	
7	
8	TX-
9	RX-

Shield Wire

DB9 MALE  
PINOUTS

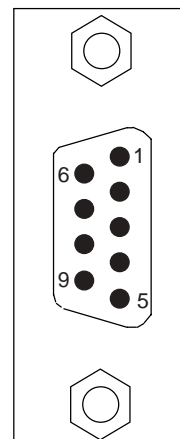

# Appendix

## 22 TOSHIBA T2 LINK PORT TO NTXS UNIT

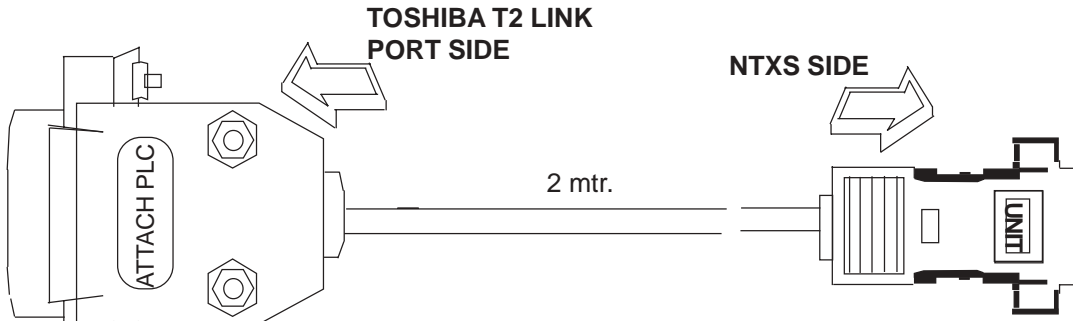

**DB15 MALE (RS485)**

SIGNALS #	Pin #
	1
RX+	2
TX+	3
	4
	5
	6
SG	7
	8
	9
RX-	10
TX-	11
	12
	13
	14
	15

Shield Wire

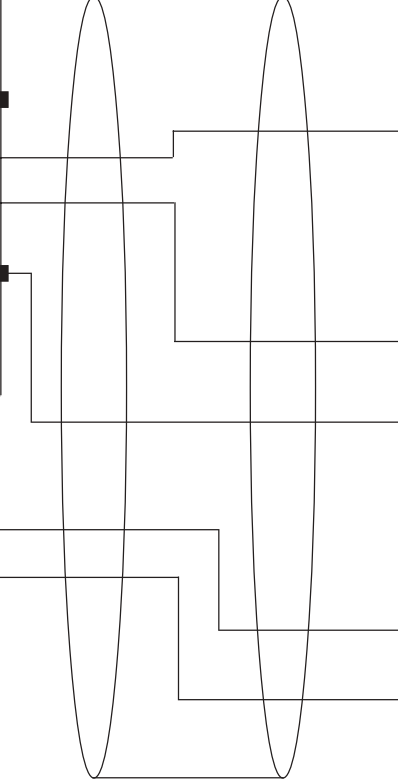

Shield Wire

NTXS SIDE

**DB9 MALE (RS485)**

Pin #	SIGNALS
1	TX+
2	
3	
4	RX+
5	SG
6	
7	
8	TX-
9	RX-

**DB9 MALE PINOUTS**

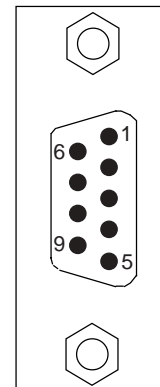

**DB15 MALE PINOUTS**

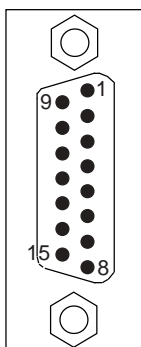

23 TOSHIBA INVERTER S SERIES TO NTXS UNIT

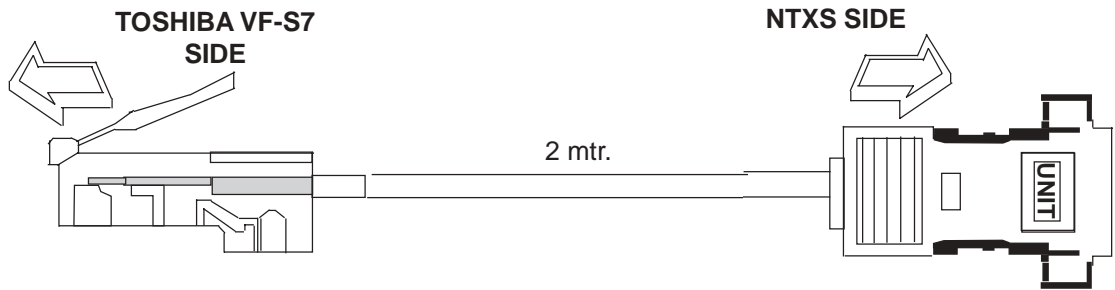

8 PIN MODULAR CONNECTOR (RS232)

SIGNALS	Pin #
	1
SG	2
RXD	3
	4
CMOS TXD	5
	6
	7
	8

Shield Wire

Shield Wire

DB9 MALE (RS232)

Pin #	SIGNALS
1	
2	
3	RXD
4	
5	SG
6	
7	CMOS TXD
8	
9	

8 PIN MODULAR CONNECTOR

PINOUTS FRONT VIEW

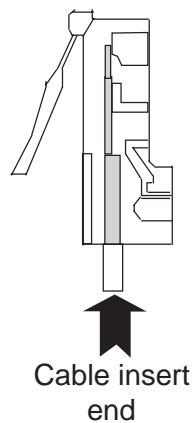

R.H.S. VIEW

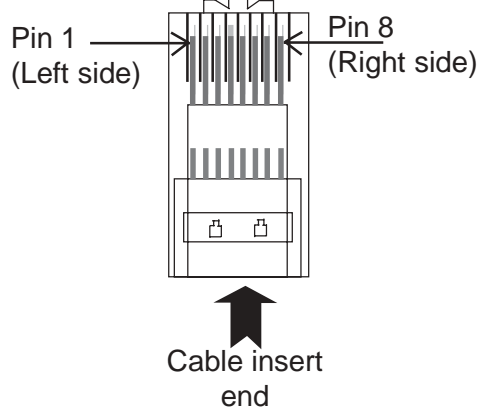

DB9 MALE PINOUTS

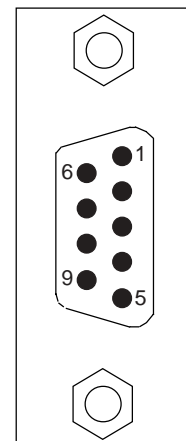

# Appendix

## 24 TSX(07/37/57) PLC TO NTXS UNIT

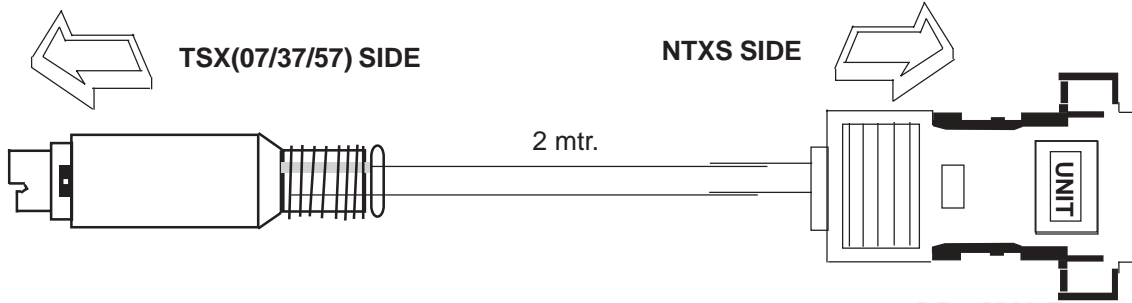

**MINIDIN 8 PIN MALE (RS485)**

SIGNALS	Pin #
A	1
B	2
	3
	4
	5
	6
GND	7
	8

Shield Wire

**DB9 MALE (RS485)**

Pin #	SIGNALS
1	TX+
2	
3	
4	RX+
5	SG
6	
7	
8	TX-
9	RX-

**8 PIN MINIDIN CONNECTOR PINOUTS**

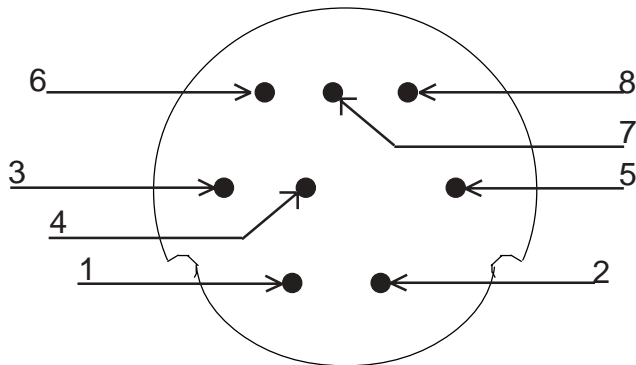

Shield Wire

**DB9 MALE PINOUTS**

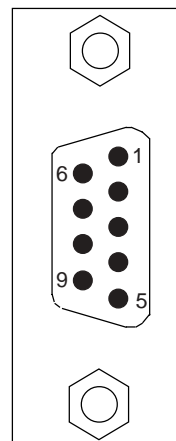

25 TWIDO PLC TO NTXS UNIT

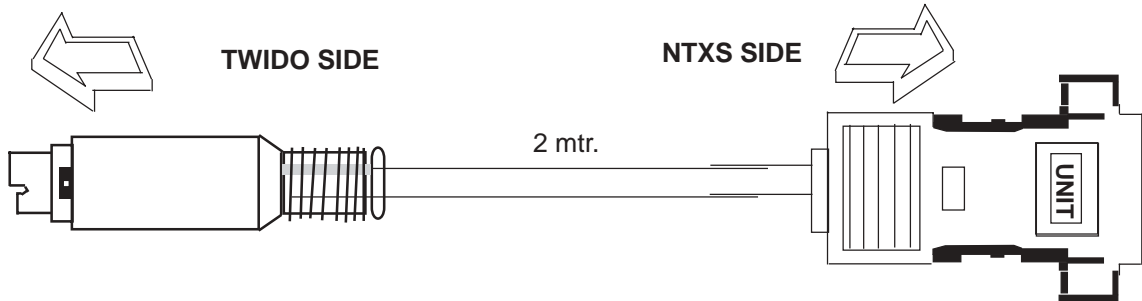

**MINIDIN 8 PIN MALE (RS485)**

SIGNALS	Pin #
A	1
B	2
	3
	4
	5
	6
GND	7
	8

**DB9 MALE (RS485)**

Pin #	SIGNALS
1	TX+
2	
3	
4	RX+
5	SG
6	
7	
8	TX-
9	RX-

**8 PIN MINIDIN CONNECTOR PINOUTS**

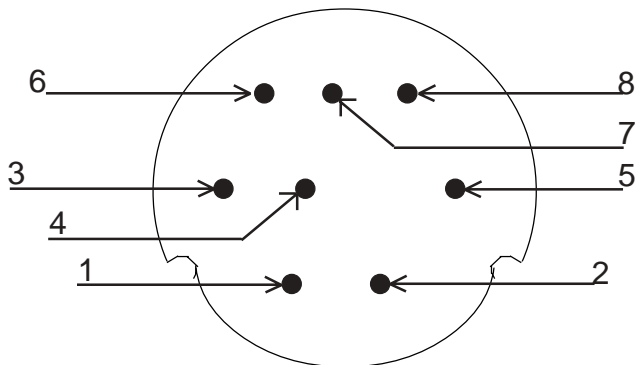

**DB9 MALE PINOUTS**

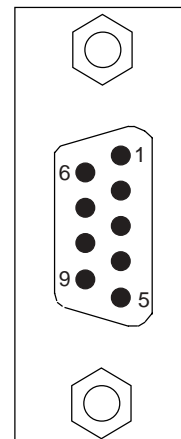





























## Appendix

---

### C List Of Features



The next chapter will guide you through the creation of your first project. Before you proceed, you may wish to read this brief list of some of the features offered in the NTXS.

ICON	NAME	DESCRIPTION
	Data Entry	Edits any register or coil from the PLC using NTXS Keypad.
	Display Data	Displays the text depending on the bit status or the value of the PLC Data register.
	Time	Displays the time in the format HH:MM:SS or HH:MM
	Date	Displays date in the format DD/MM/YY or MM/DD/YY.
	Alarm	Displays the alarm text when alarm occurs
	Line	Draws line on the unit screen.
	Rectangle	Draws rectangle on the unit screen.
	Ellipse	Draws ellipse on the unit screen.
	Rounded Rectangle	Draws rounded rectangle on the unit screen.
	Single Bargraph	Changes the bar height/width according to the value in the PLC register
	Bitmap	Used to draw bmp images on the NTXS display
	Bit Button	Performs the key's specific task or screen tasks.
	Bit Lamp	Lamp object can be used as state indicator for displaying state of PLC coil.
	Word Button	Performs a set of tasks based on the number of logical states defined in the configuration.

ICON	NAME	DESCRPITION
	Trend	Shows graphical representation of tag against real time.
	Word Lamp	Performs a set of tasks based on the number of logical states defined in the configuration.
	Numeric Keypad	Enters decimal or hex data into the register or 1 or 0 into the coil.
	Analog Meter	Changes its needle position according to the value of PLC register.
	Multiple Bargraph	Changes the bar height/width according to the value in the PLC register.
	All Screens	Shows the list of available screens.
	Application Tasklist	Defines the tasks for the application.
	Function Keys	Using this screen macros of task can be defined for Global keys.
	Global Keys	Tasks defined under this option are executed for whole application.
	Screen Tasklist	Shows the task list of the screen.
	New Application	Creates a new application.
	Open Application	Opens an existing application stored on disk.
	Save Application	Saves application by default in "Project" Directory.
	NTXS Settings	Defines unit's hardware configuration settings.
	Tags	It is the central database for the tags that need to be used in the application

# Appendix

---

ICON	NAME	DESCRPITION
	Download Application	Downloads the application & firmware in the NTXS unit
	Upload Application	Uploads application from the NTXS memory



**D List Of Supported Devices**

Sr No	PLC
1	Allen Bradley DF1
2	Aromat FP Series
3	Control Techniques
4	Danfoss drive
5	GE-90 Series
6	GE-90 series SNP-X
7	Idec PLCs
8	Keyence KV Series
9	Koyo DL205
10	LG Master-K 300S
11	LG MASTER-K Series PLCs
12	Mitsubishi FX
13	Modbus( Unit as Master)
14	Modbus ( Unit as Slave)
15	Omron Host Link
16	Omron NT Link
17	Omron/Yaskawa Inverters
18	Siemens Step-7 Micro
19	Siemens-S7 300 Series PLCs
20	Toshiba T Series
21	Toshiba (Link Port) Series PLCs
22	Toshiba Inverters
23	Unitelway (07\37\57)PLCs
24	Xtradrive
25	Yokogawa PLC
26	Twido

## Appendix

---

### E Technical Support



**Omron Europe B.V.**  
Wegalaan 67-69  
NL-2132 JD Hoofddorp  
The Netherlands

 :(+31)23-5681300

 Fax :(+31)23 5681388

Website: [www.omron-industrial.com](http://www.omron-industrial.com)

# Index

## A

Add a Constant To Tag 118  
Add Tag B To Tag A 120  
Analog Meter 93  
Animation Properties 67  
Application TaskList 109  
Associated Screens 55

## B

Bargraph 71  
Bit Button 74  
Bit Lamp 81  
Bitmap 72

## C

Communicate Menu 47  
Connecting HMI to your Computer 31  
Copy NTXS Block to NTXS/PLC Block 126  
Copy PLC Block to NTXS Block 126  
Copy RTC to PLC Block 127  
Copy Tag B to Tag A 122  
Copy tag to LED 124  
Copy Tag to STR 123  
Creating New Application 48  
Creating Screens 54

## D

Data Entry Object 55  
Data Entry Objects 61  
Date 66  
Default System Tags 53  
Define Menu 46  
Delay 124  
Display data 63  
Display Data Object 56  
Display only 54

## E

Ellipse 70

## F

File Menu 45  
Flashing Animation 68

## G

Global And Power On Task 56  
Global Keys 58  
Global Keys Tasklist 113  
Go To Screen 116  
Goto Next Screen 116

Goto Popup Screen 127  
Goto Previous Screen 116  
Graphic Wizards 69

## H

Help Menu 48

## I

Installing NTXS Software 32

## K

Key Tasklist 113  
Keys' Specific Tasks 128

## L

Line 69

## M

Multi-Language Text Wizard 139  
Multiple Bargraph 87

## N

Network Configuration 35, 36, 37  
NTXS Menu Structure 43  
Numeric Keypad 103

## P

Print Data 126  
Print Once/display 54  
Print Only 54  
Printing from NTXS Software 156  
Printing from NTXS unit 155  
Protecting Screen Using Password 55

## R

Real Time Trend 98  
Rectangle 70  
Rounded Rectangle 71

## S

Screen TaskList 111  
Screen Keys 59  
Set RTC 125  
Show / Hide Animation 68  
Specifications of NTXS Series 8  
Starting NTXS Software 32  
Subtract a Constant From Tag 119  
Subtract Tag B from Tag A 120  
Support 204  
Swap Tag A and Tag B 123

## **T**

Tag Database 50  
Tasks 109  
Text Object 63  
Time 66  
Toggle bit 122  
Touch-Screen Tasklist 115  
Turn bit Off 121  
Turn bit On 121

## **U**

Utilities Menu 47

## **W**

Wait 125  
Wizards 73  
Word Button 78  
Word Lamp 85  
Write Value To Tag 117

# Terms and Conditions of Sale

1. **Offer; Acceptance.** These terms and conditions (these "Terms") are deemed part of all quotes, agreements, purchase orders, acknowledgments, price lists, catalogs, manuals, brochures and other documents, whether electronic or in writing, relating to the sale of products or services (collectively, the "Products") by Omron Electronics LLC and its subsidiary companies ("Omron"). Omron objects to any terms or conditions proposed in Buyer's purchase order or other documents which are inconsistent with, or in addition to, these Terms.
2. **Prices; Payment Terms.** All prices stated are current, subject to change without notice by Omron. Omron reserves the right to increase or decrease prices on any unshipped portions of outstanding orders. Payments for Products are due net 30 days unless otherwise stated in the invoice.
3. **Discounts.** Cash discounts, if any, will apply only on the net amount of invoices sent to Buyer after deducting transportation charges, taxes and duties, and will be allowed only if (i) the invoice is paid according to Omron's payment terms and (ii) Buyer has no past due amounts.
4. **Interest.** Omron, at its option, may charge Buyer 1-1/2% interest per month or the maximum legal rate, whichever is less, on any balance not paid within the stated terms.
5. **Orders.** Omron will accept no order less than \$200 net billing.
6. **Governmental Approvals.** Buyer shall be responsible for, and shall bear all costs involved in, obtaining any government approvals required for the importation or sale of the Products.
7. **Taxes.** All taxes, duties and other governmental charges (other than general real property and income taxes), including any interest or penalties thereon, imposed directly or indirectly on Omron or required to be collected directly or indirectly by Omron for the manufacture, production, sale, delivery, importation, consumption or use of the Products sold hereunder (including customs duties and sales, excise, use, turnover and license taxes) shall be charged to and remitted by Buyer to Omron.
8. **Financial.** If the financial position of Buyer at any time becomes unsatisfactory to Omron, Omron reserves the right to stop shipments or require satisfactory security or payment in advance. If Buyer fails to make payment or otherwise comply with these Terms or any related agreement, Omron may (without liability and in addition to other remedies) cancel any unshipped portion of Products sold hereunder and stop any Products in transit until Buyer pays all amounts, including amounts payable hereunder, whether or not then due, which are owing to it by Buyer. Buyer shall in any event remain liable for all unpaid accounts.
9. **Cancellation; Etc.** Orders are not subject to rescheduling or cancellation unless Buyer indemnifies Omron against all related costs or expenses.
10. **Force Majeure.** Omron shall not be liable for any delay or failure in delivery resulting from causes beyond its control, including earthquakes, fires, floods, strikes or other labor disputes, shortage of labor or materials, accidents to machinery, acts of sabotage, riots, delay in or lack of transportation or the requirements of any government authority.
11. **Shipping; Delivery.** Unless otherwise expressly agreed in writing by Omron:
  - a. Shipments shall be by a carrier selected by Omron; Omron will not drop ship except in "break down" situations.
  - b. Such carrier shall act as the agent of Buyer and delivery to such carrier shall constitute delivery to Buyer;
  - c. All sales and shipments of Products shall be FOB shipping point (unless otherwise stated in writing by Omron), at which point title and risk of loss shall pass from Omron to Buyer; provided that Omron shall retain a security interest in the Products until the full purchase price is paid;
  - d. Delivery and shipping dates are estimates only; and
  - e. Omron will package Products as it deems proper for protection against normal handling and extra charges apply to special conditions.
12. **Claims.** Any claim by Buyer against Omron for shortage or damage to the Products occurring before delivery to the carrier must be presented in writing to Omron within 30 days of receipt of shipment and include the original transportation bill signed by the carrier noting that the carrier received the Products from Omron in the condition claimed.
13. **Warranties.** (a) **Exclusive Warranty.** Omron's exclusive warranty is that the Products will be free from defects in materials and workmanship for a period of twelve months from the date of sale by Omron (or such other period expressed in writing by Omron). Omron disclaims all other warranties, express or implied. (b) **Limitations.** OMRON MAKES NO WARRANTY OR REPRESENTATION, EXPRESS OR IMPLIED, ABOUT NON-INFRINGEMENT, MERCHANTABILITY OR FITNESS FOR A PARTICULAR PURPOSE OF THE PRODUCTS. BUYER ACKNOWLEDGES THAT IT ALONE HAS DETERMINED THAT THE PRODUCTS WILL SUITABLY MEET THE REQUIREMENTS OF THEIR INTENDED USE. Omron further disclaims all warranties and responsibility of any type for claims or expenses based on infringement by the Products or otherwise of any intellectual property right. (c) **Buyer Remedy.** Omron's sole obligation hereunder shall be, at Omron's election, to (i) replace (in the form originally shipped with Buyer responsible for labor charges for removal or replacement thereof) the non-complying Product, (ii) repair the non-complying Product, or (iii) repay or credit Buyer an amount equal to the purchase price of the non-complying Product; provided that in no event shall Omron be responsible for warranty, repair, indemnity or any other claims or expenses regarding the Products unless Omron's analysis confirms that the Products were properly handled, stored, installed and maintained and not subject to contamination, abuse, misuse or inappropriate modification. Return of any Products by Buyer must be approved in writing by Omron before shipment. Omron Companies shall not be liable for the suitability or unsuitability or the results from the use of Products in combination with any electrical or electronic components, circuits, system assemblies or any other materials or substances or environments. Any advice, recommendations or information given orally or in writing, are not to be construed as an amendment or addition to the above warranty. See <http://www.omron247.com> or contact your Omron representative for published information.
14. **Limitation on Liability; Etc.** OMRON COMPANIES SHALL NOT BE LIABLE FOR SPECIAL, INDIRECT, INCIDENTAL, OR CONSEQUENTIAL DAMAGES, LOSS OF PROFITS OR PRODUCTION OR COMMERCIAL LOSS IN ANY WAY CONNECTED WITH THE PRODUCTS, WHETHER SUCH CLAIM IS BASED IN CONTRACT, WARRANTY, NEGLIGENCE OR STRICT LIABILITY. Further, in no event shall liability of Omron Companies exceed the individual price of the Product on which liability is asserted.
15. **Indemnities.** Buyer shall indemnify and hold harmless Omron Companies and their employees from and against all liabilities, losses, claims, costs and expenses (including attorney's fees and expenses) related to any claim, investigation, litigation or proceeding (whether or not Omron is a party) which arises or is alleged to arise from Buyer's acts or omissions under these Terms or in any way with respect to the Products. Without limiting the foregoing, Buyer (at its own expense) shall indemnify and hold harmless Omron and defend or settle any action brought against such Companies to the extent based on a claim that any Product made to Buyer specifications infringed intellectual property rights of another party.
16. **Property; Confidentiality.** Any intellectual property in the Products is the exclusive property of Omron Companies and Buyer shall not attempt to duplicate it in any way without the written permission of Omron. Notwithstanding any charges to Buyer for engineering or tooling, all engineering and tooling shall remain the exclusive property of Omron. All information and materials supplied by Omron to Buyer relating to the Products are confidential and proprietary, and Buyer shall limit distribution thereof to its trusted employees and strictly prevent disclosure to any third party.
17. **Export Controls.** Buyer shall comply with all applicable laws, regulations and licenses regarding (i) export of products or information; (ii) sale of products to "forbidden" or other proscribed persons; and (iii) disclosure to non-citizens of regulated technology or information.
18. **Miscellaneous.** (a) **Waiver.** No failure or delay by Omron in exercising any right and no course of dealing between Buyer and Omron shall operate as a waiver of rights by Omron. (b) **Assignment.** Buyer may not assign its rights hereunder without Omron's written consent. (c) **Law.** These Terms are governed by the law of the jurisdiction of the home office of the Omron company from which Buyer is purchasing the Products (without regard to conflict of law principles). (d) **Amendment.** These Terms constitute the entire agreement between Buyer and Omron relating to the Products, and no provision may be changed or waived unless in writing signed by the parties. (e) **Severability.** If any provision hereof is rendered ineffective or invalid, such provision shall not invalidate any other provision. (f) **Setoff.** Buyer shall have no right to set off any amounts against the amount owing in respect of this invoice. (g) **Definitions.** As used herein, "including" means "including without limitation"; and "Omron Companies" (or similar words) mean Omron Corporation and any direct or indirect subsidiary or affiliate thereof.

## Certain Precautions on Specifications and Use

1. **Suitability of Use.** Omron Companies shall not be responsible for conformity with any standards, codes or regulations which apply to the combination of the Product in the Buyer's application or use of the Product. At Buyer's request, Omron will provide applicable third party certification documents identifying ratings and limitations of use which apply to the Product. This information by itself is not sufficient for a complete determination of the suitability of the Product in combination with the end product, machine, system, or other application or use. Buyer shall be solely responsible for determining appropriateness of the particular Product with respect to Buyer's application, product or system. Buyer shall take application responsibility in all cases but the following is a non-exhaustive list of applications for which particular attention must be given:
  - (i) Outdoor use, uses involving potential chemical contamination or electrical interference, or conditions or uses not described in this document.
  - (ii) Use in consumer products or any use in significant quantities.
  - (iii) Energy control systems, combustion systems, railroad systems, aviation systems, medical equipment, amusement machines, vehicles, safety equipment, and installations subject to separate industry or government regulations.
  - (iv) Systems, machines and equipment that could present a risk to life or property. Please know and observe all prohibitions of use applicable to this Product.

NEVER USE THE PRODUCT FOR AN APPLICATION INVOLVING SERIOUS RISK TO LIFE OR PROPERTY OR IN LARGE QUANTITIES WITHOUT ENSURING THAT THE SYSTEM AS A WHOLE HAS BEEN DESIGNED TO ADDRESS THE RISKS, AND THAT THE OMRON'S PRODUCT IS PROPERLY RATED AND INSTALLED FOR THE INTENDED USE WITHIN THE OVERALL EQUIPMENT OR SYSTEM.
2. **Programmable Products.** Omron Companies shall not be responsible for the user's programming of a programmable Product, or any consequence thereof.
3. **Performance Data.** Data presented in Omron Company websites, catalogs and other materials is provided as a guide for the user in determining suitability and does not constitute a warranty. It may represent the result of Omron's test conditions, and the user must correlate it to actual application requirements. Actual performance is subject to the Omron's Warranty and Limitations of Liability.
4. **Change in Specifications.** Product specifications and accessories may be changed at any time based on improvements and other reasons. It is our practice to change part numbers when published ratings or features are changed, or when significant construction changes are made. However, some specifications of the Product may be changed without any notice. When in doubt, special part numbers may be assigned to fix or establish key specifications for your application. Please consult with your Omron's representative at any time to confirm actual specifications of purchased Product.
5. **Errors and Omissions.** Information presented by Omron Companies has been checked and is believed to be accurate; however, no responsibility is assumed for clerical, typographical or proofreading errors or omissions.

# OMRON

Automation...simple...powerful.

**OMRON ELECTRONICS LLC • THE AMERICAS HEADQUARTERS**

Schaumburg, IL USA • 847.843.7900 • 800.556.6766 • [www.omron247.com](http://www.omron247.com)

**OMRON CANADA, INC. • HEAD OFFICE**

Toronto, ON, Canada • 416.286.6465 • 866.986.6766 • [www.omron.ca](http://www.omron.ca)

**OMRON ELETRÔNICA DO BRASIL LTDA • HEAD OFFICE**

São Paulo, SP, Brasil • 55.11.2101.6300 • [www.omron.com.br](http://www.omron.com.br)

**OMRON ELECTRONICS MEXICO SA DE CV • HEAD OFFICE**

Apodaca, N.L. • 52.811.156.99.10 • [mela@omron.com](mailto:mela@omron.com)

V03E-EN-02

Note: Specifications are subject to change.

**OMRON ARGENTINA • SALES OFFICE**

Cono Sur • 54.11.4787.1129

**OMRON CHILE • SALES OFFICE**

Santiago 56.2206.4592

**OTHER OMRON LATIN AMERICA SALES**

56.2206.4592

© 2008 Omron Electronics LLC

Printed in U.S.A.