

CJ-series Ethernet Functions
CJ1M-CPU1_-ETN

CJ1M CPU Units with Ethernet Functions

OPERATION MANUAL

OMRON

CJ-series Ethernet Functions
CJ1M-CPU1□-ETN
CJ1M CPU Units with
Ethernet Functions



Operation Manual

Revised September 2009

Notice:

OMRON products are manufactured for use according to proper procedures by a qualified operator and only for the purposes described in this manual.

The following conventions are used to indicate and classify precautions in this manual. Always heed the information provided with them. Failure to heed precautions can result in injury to people or damage to property.

-  **DANGER** Indicates an imminently hazardous situation which, if not avoided, will result in death or serious injury.
-  **WARNING** Indicates a potentially hazardous situation which, if not avoided, could result in death or serious injury.
-  **Caution** Indicates a potentially hazardous situation which, if not avoided, may result in minor or moderate injury, or property damage.

OMRON Product References

All OMRON products are capitalized in this manual. The word “Unit” is also capitalized when it refers to an OMRON product, regardless of whether or not it appears in the proper name of the product.

The abbreviation “Ch,” which appears in some displays and on some OMRON products, often means “word” and is abbreviated “Wd” in documentation in this sense.

The abbreviation “PLC” means Programmable Controller. “PC” is used, however, in some Programming Device displays to mean Programmable Controller.

Visual Aids

The following headings appear in the left column of the manual to help you locate different types of information.

Note Indicates information of particular interest for efficient and convenient operation of the product.

- 1,2,3...** 1. Indicates lists of one sort or another, such as procedures, checklists, etc.

© OMRON, 2004

All rights reserved. No part of this publication may be reproduced, stored in a retrieval system, or transmitted, in any form, or by any means, mechanical, electronic, photocopying, recording, or otherwise, without the prior written permission of OMRON.

No patent liability is assumed with respect to the use of the information contained herein. Moreover, because OMRON is constantly striving to improve its high-quality products, the information contained in this manual is subject to change without notice. Every precaution has been taken in the preparation of this manual. Nevertheless, OMRON assumes no responsibility for errors or omissions. Neither is any liability assumed for damages resulting from the use of the information contained in this publication.

Unit Versions of CS/CJ-series CPU Units

Unit Versions

Model Numbers and Functional Elements

A “unit version” has been introduced to manage CPU Units in the CS/CJ Series according to differences in functionality accompanying Unit upgrades.

The CJ1M-CPU1□-ETN is comprised of a CPU functional element with the same functionality as a CJ1M-CPU1□ CPU Unit with version 3.0 or later and an Ethernet functional element. The following table lists the model numbers for CJ1M CPU Units with Ethernet Functions, the models of CPU functional element, and the unit versions of the functional elements.

The Ethernet functional element incorporates the basic functionality of the CJ1W-ETN21 CJ-series Ethernet Unit and has a separate unit version. Therefore, unit versions are provided for the CPU functional element and Ethernet functional element. A single unit version for the CJ1M CPU Unit with Ethernet Functions as a whole is not provided.

Product name	Product model number	Configuration		
		CPU functional element		Ethernet functional element
		CPU Unit model with same functionality	Functional element unit version	Functional element unit version
CPU Unit with Ethernet Functions	CJ1M-CPU11-ETN	CJ1M-CPU11	Ver. 3.0 or later	Ver. 1.0 or later
	CJ1M-CPU12-ETN	CJ1M-CPU12	Ver. 3.0 or later	Ver. 1.0 or later
	CJ1M-CPU13-ETN	CJ1M-CPU13	Ver. 3.0 or later	Ver. 1.0 or later

Notation of Unit Versions on Products

The unit version is given to the right of the lot number on the nameplate of the products for which unit versions are being managed, as shown below.

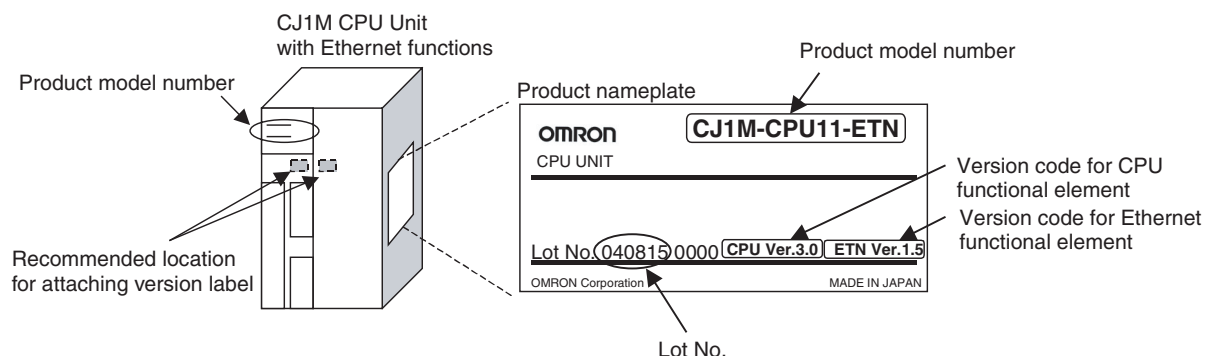

- The CJ1M-CPU1□-ETN is provided with a unit version code for both the CPU functional element and the Ethernet functional element.
- Unit versions for CPU functional elements start from version 3.0.
- Unit versions for Ethernet functional elements start from version 1.0.

Confirming Unit Versions with Support Software

CX-Programmer version 4.0 can be used to confirm the unit version using one of the following two methods.

- Using the **PLC Information**
- Using the **Unit Manufacturing Information** (This method can be used for Special I/O Units and CPU Bus Units as well.)

Note CX-Programmer version 3.3 or lower cannot be used to confirm unit versions.

PLC Information: Confirming CPU Functional Element Version Codes

- If you know the device type and CPU type, select them in the *Change PLC* Dialog Box, go online, and select **PLC - Edit - Information** from the

menus. In the *PLC Information* Dialog Box, select either CPU11, CPU12, or CPU13 as the CPU type for CJ1M.

- If you do not know the device type and CPU type, but are connected directly to the CPU Unit on a serial line, select ***PLC - Auto Online*** to go online, and then select ***PLC - Edit - Information*** from the menus.

In either case, the following *PLC Information* Dialog Box will be displayed.

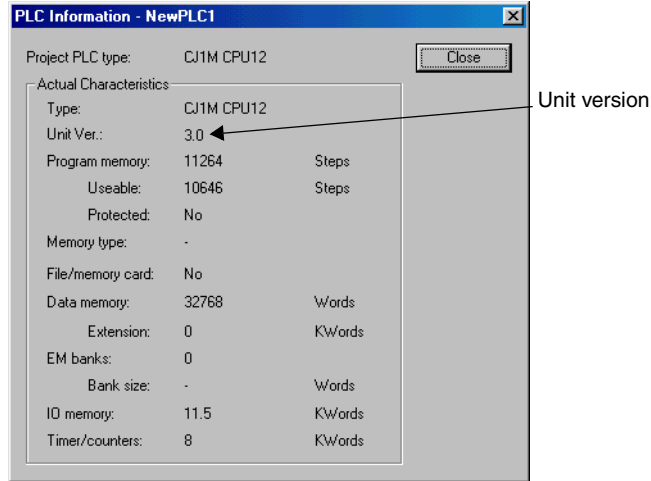

Use the above display to confirm the unit version of the CPU functional element.

Unit Manufacturing Information: Confirming CPU Functional Element and Ethernet Functional Element Unit Versions

In the *IO Table* Window, right-click and select ***Unit Manufacturing information - CPU Unit***.

- Select ***CPU Unit*** for the CPU functional element version code.

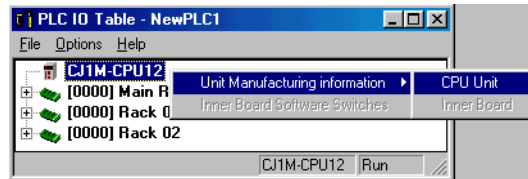

The following *Unit Manufacturing Information* Dialog Box will be displayed

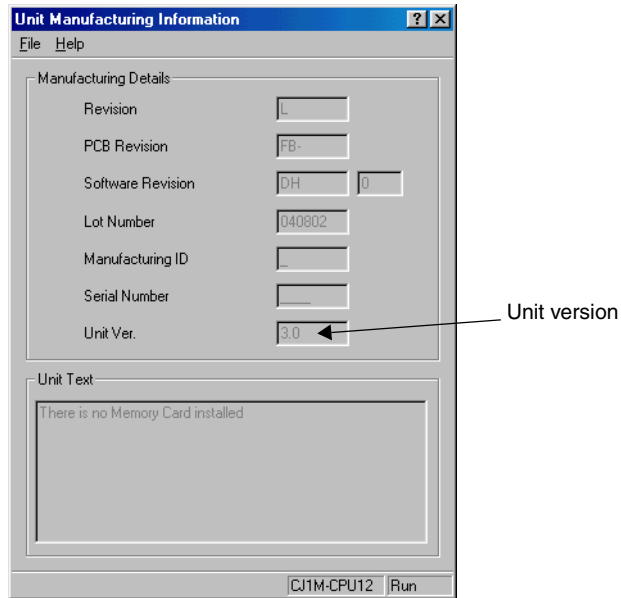

Use the above display to confirm the unit version of the CPU functional element connected online.

- Select Ethernet Unit for the Ethernet functional element version code

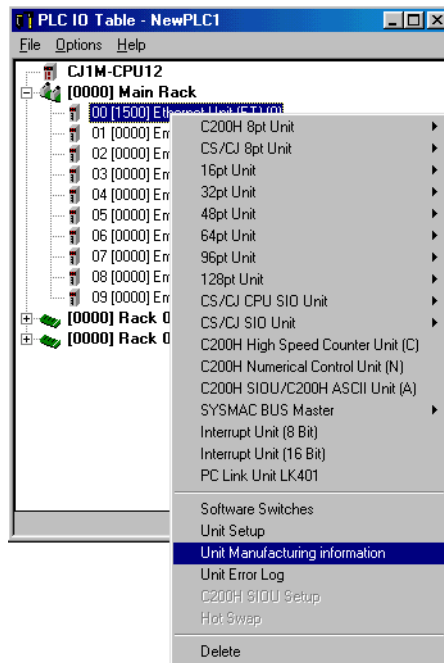

The following Unit Manufacturing Information Dialog Box will be displayed.

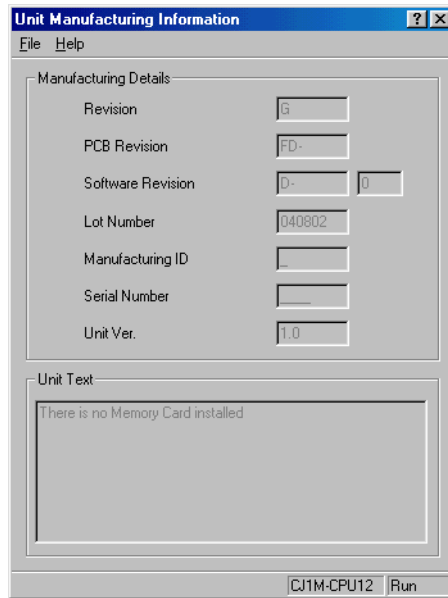

Use the above display to confirm the unit version of the Ethernet functional element connected online.

Using the Unit Version Labels

The following two unit version labels are provided with the Unit.

<div style="display: flex; justify-content: space-around;"> <div style="border: 1px solid black; border-radius: 5px; padding: 2px 5px;">Ver. 3.0</div> <div style="border: 1px solid black; border-radius: 5px; padding: 2px 5px;">Ver.</div> </div> <div style="display: flex; justify-content: space-around; margin-top: 5px;"> <div style="border: 1px solid black; border-radius: 5px; padding: 2px 5px;">Ver. 3.0</div> <div style="border: 1px solid black; border-radius: 5px; padding: 2px 5px;">Ver.</div> </div> <p>バージョンアップによるユニットの搭載機能の差異を管理するためのラベルです。必要に応じて、製品の前面に貼り付けてご使用ください。</p> <p>These Labels can be used to manage differences in the available functions among the Units. Place the appropriate label on the front of the Unit to show what Unit version is actually being used.</p>	<div style="display: flex; justify-content: space-around;"> <div style="border: 1px solid black; border-radius: 5px; padding: 2px 5px;">Ver. 1.0</div> <div style="border: 1px solid black; border-radius: 5px; padding: 2px 5px;">Ver.</div> </div> <div style="display: flex; justify-content: space-around; margin-top: 5px;"> <div style="border: 1px solid black; border-radius: 5px; padding: 2px 5px;">Ver. 1.0</div> <div style="border: 1px solid black; border-radius: 5px; padding: 2px 5px;">Ver.</div> </div> <p>バージョンアップによるユニットの搭載機能の差異を管理するためのラベルです。必要に応じて、製品の前面に貼り付けてご使用ください。</p> <p>These Labels can be used to manage differences in the available functions among the Units. Place the appropriate label on the front of the Unit to show what Unit version is actually being used.</p>
--	--

Attach the Ver. 3.0 label to the CPU functional element and the Ver. 1.0 label to the Ethernet functional element to differentiate the unit versions from previous CPU Units and Ethernet Units.

Unit Versions and Supported Functions

The improvements made for upgrades in the version of the Ethernet functional element are listed below.

Functions Supported for Version 1.5 or Higher of the Ethernet Functional Element

Function	Description
Added CIDR function to subnet mask settings.	An option setting has been added to the subnet mask settings to enable CIDR. Enabling CIDR enables using the IP address with classless subnet mask settings.
Changed position of node address setting switches	The position of the node address setting switches was changed. The setting method and setting range are the same as previously.

Unit Versions and Programming Devices

CX-Programmer version 5.0 or higher must be used to enable using the functions added for CPU functional element version 3.0. The following tables show the relationship between unit versions and CX-Programmer versions.

Unit Versions and Programming Devices

CPU Unit with Ethernet Functions	Functions		CX-Programmer					Program- ming Console
			Ver. 3.2 or lower	Ver. 3.3	Ver. 4.0	Ver. 5.0	Ver. 6.0 or higher	
CJ1M-CPU11-ETN CJ1M-CPU12-ETN CJ1M-CPU13-ETN	Functions added for unit version 3.0 (function blocks, etc.)	Using new functions	---	---	---	OK	OK	No restrictions
		Not using new functions	OK	OK	OK	OK	OK	
CJ1M-CPU11-ETN	Functions added for unit version 2.0	Using new functions	---	---	OK	OK	OK	
		Not using new functions	---	OK	OK	OK	OK	
CJ1M-CPU12-ETN CJ1M-CPU13-ETN	Functions added for unit version 2.0	Using new functions	---	---	OK	OK	OK	
		Not using new functions	OK	OK	OK	OK	OK	

Device Type Setting

The unit version does not affect the setting made for the device type on the CX-Programmer. Select the device type as shown in the following table regardless of the unit version of the CPU functional element.

CPU Unit with Ethernet Functions model	Device type setting on CX-Programmer Ver. 4.0 or higher
CJ1M-CPU1□-ETN	CJ1M

CPU Type Setting

The -ETN suffix is not shown in the CPU type setting for the CPU Unit with Ethernet Functions. Select the CPU type as shown in the following table.

CPU Unit with Ethernet Functions model	CPU type setting on CX-Programmer Ver. 4.0 or higher
CJ1M-CPU11-ETN	CPU11
CJ1M-CPU12-ETN	CPU12
CJ1M-CPU13-ETN	CPU13

Troubleshooting Problems with Unit Versions on the CX-Programmer

Problem	Cause	Solution
 <p>After the above message is displayed, a compiling error will be displayed on the <i>Compile</i> Tab Page in the Output Window.</p>	<p>An attempt was made using CX-Programmer version 4.0 or higher to download a program containing instructions supported only by CPU Units Ver. 2.0 or later to a Pre-Ver. 2.0 CPU Units.</p>	<p>Check the program or change the CPU Unit to which the program is to be downloaded to a CPU Unit Ver. 2.0 or later.</p>
	<p>An attempt was made using CX-Programmer version 4.0 or higher to download a PLC Setup containing settings supported only by CPU Units Ver. 2.0 or later (i.e., not set to their default values) to a Pre-Ver. 2.0 CPU Units.</p>	<p>Check the settings in the PLC Setup or change the CPU Unit to which the settings are to be downloaded to a CPU Unit Ver. 2.0 or later.</p>
<p>“????” is displayed in a program transferred from the PLC to the CX-Programmer.</p>	<p>CX-Programmer version 3.3 or lower was used to upload a program containing instructions supported only by CPU Units Ver. 2.0 or later from a CPU Unit Ver. 2.0 or later.</p>	<p>The new instructions cannot be uploaded using CX-Programmer version 3.3 or lower. Use CX-Programmer version 4.0 or higher.</p>

TABLE OF CONTENTS

PRECAUTIONS	xxiii
1 Intended Audience	xxiv
2 General Precautions	xxiv
3 Safety Precautions	xxiv
4 Operating Environment Precautions	xxvi
5 Application Precautions	xxvii
6 Conformance to EC Directives	xxx
SECTION 1	
Introduction and Specifications	1
1-1 Introduction	2
1-2 Specifications	3
1-3 Part Names and Dimensions	7
SECTION 2	
Unit Setup and Memory Allocations	15
2-1 Unit Setup	16
2-2 Ethernet Functional Element Memory Allocations	17
2-3 Web Function	22
SECTION 3	
Inspection and Maintenance	29
3-1 Inspections	30
3-2 Replacing User-serviceable Parts	32
Index	37
Revision History	39

TABLE OF CONTENTS

About this Manual:

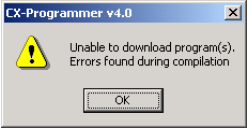
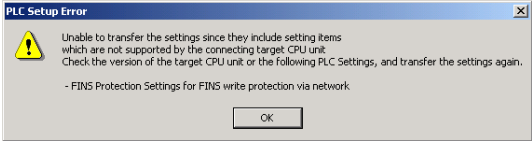
This manual describes the installation and operation of the CJ1W-CPU1□-ETN CJ1M CPU Units with Ethernet Functions and includes the sections described below. The CJ1W-CPU1□-ETN is a compact advanced Programmable Controller (PLC) with built-in Ethernet ports.

In this manual, “CJ Series” refers to CJ1-H, CJ1, and CJ1M CPU Units and also CJ1M with Ethernet Functions. CJ1M CPU Units with Ethernet Functions refer to CPU Units with a CJ1W-CPU1□-ETN model number. The CS Series and CJ Series are subdivided as shown in the following table.

Unit	CS Series	CJ Series
CPU Units	CS1-H CPU Units: CS1H-CPU□□H CS1G-CPU□□H	CJ1-H CPU Units: CJ1H-CPU□□H CJ1G-CPU□□H CJ1G-CPU□□P
	CS1 CPU Units: CS1H-CPU□□-EV1 CS1G-CPU□□-EV1	CJ1 CPU Units: CJ1G-CPU□□-EV1 CJ1M-CPU□□
	CS1D CPU Units: CS1D CPU Units for Duplex-CPU System: CS1D-CPU□□H CS1D CPU Units for Single-CPU System: CS1D-CPU□□S CS1D Process CPU Units: CS1D-CPU□□P	CJ1M CPU Units with Ethernet Functions: CJ1M-CPU1□-ETN
Basic I/O Units	CS-series Basic I/O Units	CJ-series Basic I/O Units
Special I/O Units	CS-series Special I/O Units	CJ-series Special I/O Units
CPU Bus Units	CS-series CPU Bus Units	CJ-series CPU Bus Units
Power Supply Units	CS-series Power Supply Units	CJ-series Power Supply Units

This manual contains the following sections.

Section 1 introduces the special features, functions, and specifications of the CJ1M CPU Units with Ethernet Functions and describes the differences between the Ethernet functional element incorporated into the CPU Unit and separate Ethernet Units. Part names and their functions, and the Unit’s dimensions are also provided.

Section 2 describes the settings made in the Unit Setup using the CX-Programmer, and also provides information on memory allocations for the Ethernet functional element, including information on status and setting/displaying IP addresses. Information on setting and monitoring from the Web function is also provided.

Section 3 provides information on battery replacement and maintenance.

The CJ1M-CPU1□-ETN incorporates a CPU functional element combined with an Ethernet functional element. The CPU functional element has the same functionality as a CJ1M-CPU1□ CJ1M CPU Unit (without built-in I/O) with unit version 3.0 or later. The Ethernet functional element provides the main functions of the CJ1W-ETN21 Ethernet Unit.

Product name	Product model number	Configuration	
		CPU functional element	Ethernet functional element
		CPU Unit with same functionality	Ethernet Unit with similar functionality
CPU Unit with Ethernet Functions	CJ1M-CPU11-ETN	CJ1M-CPU11	CJ1W-ETN21
	CJ1M-CPU12-ETN	CJ1M-CPU12	
	CJ1M-CPU13-ETN	CJ1M-CPU13	

Therefore, in addition to the sections of this manual, refer to the operation manuals for CJ1M CPU Units and CJ1W-ETN21 Ethernet Units as required.

Using this Manual

This manual provides only an overview of the CJ1M-CPU1□-ETN's Unit specifications and information on the unit settings, memory allocations, and Web function of the Ethernet functional element. Refer to the following sections according to the required information.

Required information	Relevant section
Overview and specifications	<i>SECTION 1 Introduction and Specifications</i>
List of unit settings for the Ethernet functional element	<i>2-1 Unit Setup</i>
I/O allocations such as status area, and IP address display/setting area	<i>2-2 Ethernet Functional Element Memory Allocations</i>
Setting/monitoring methods using the Web function	<i>2-3 Web Function</i>
Battery replacement and other maintenance information	<i>SECTION 3 Inspection and Maintenance</i>

For details on other information, refer to the following related manuals.

Please read this manual and all related manuals listed in the following tables and be sure you understand information provided before attempting to install or use CJ-series CPU Units in a PLC System.

CPU Functional Elements

For details on CPU functional elements, refer to the following manuals related to CJ1M CJ1M-CPU1□ CPU Units (without built-in I/O).

CPU Functional Elements

Name	Cat. No.	Contents
SYSMAC CJ Series CJ1G/H-CPU□□H, CJ1M-CPU□□, CJ1M-CPU□□ CJ1G-CPU□□ Programmable Controllers Operation Manual	W393	Provides an outlines of and describes the design, installation, maintenance, and other basic operations for the CJ-series PLCs. (This manual)
SYSMAC CS/CJ Series CS1G/H-CPU□□-EV1, CS1G/H-CPU□□H, CS1D-CPU□□S, CS1D-CPU□□H, CJ1G-CPU□□, CJ1G/H-CPU□□H, CJ1M-CPU□□ Programmable Controllers Programming Manual	W394	This manual describes programming and other methods to use the functions of the CS/CJ-series PLCs.
SYSMAC CS/CJ/NSJ Series CS1□-CPU□□□-□□, CJ1□-CPU□□□-□□, CJ2□-CPU□□□-□□, NSJ□□-□□□□-□□□ Programmable Controllers Instructions Reference Manual	W474	Describes the ladder diagram programming instructions supported by CS/CJ-series PLCs and NSJ-series Controllers. When programming, use this manual together with the manuals for your CPU Unit or Controller.
SYSMAC CS/CJ Series CS1G/H-CPU□□-EV1, CS1G/H-CPU□□H, CS1D- CPU□□H, CS1D-CPU□□S, CJ1G-CPU□□, CJ1G/H- CPU□□H, CJ1M-CPU□□, CS1W-SCB21-V1/41-V1, CS1W-SCU21-V1, CJ1W-SCU21-V1/41-V1 Communications Commands Reference Manual	W342	Describes the C-series (Host Link) and FINS communications commands used with CS/CJ-series PLCs.

Peripheral Devices

Name	Cat. No.	Contents
SYSMAC CS/CJ Series CQM1H-PRO01-E, C200H-PRO27-E, CQM1-PRO01-E Programming Consoles Operation Manual	W341	Provides information on how to program and operate CS/CJ-series PLCs using a Programming Console.
SYSMAC WS02-CXP□□-E CX-Programmer Operation Manual Version 8.□	W446	Provides information on how to use the CX-Programmer, a programming device that supports the CS/CJ-series PLCs, and the CX-Net contained within CX-Programmer. This manual does not provide information on function blocks, which are covered in W447 (below). When programming, use this manual together with the Operation Manual (CS Series: W339, CJ Series: W393), Programming Manual (W394), and Instructions Reference Manual (W474).
SYSMAC WS02-CXPC1-V8 CX-Programmer Ver. 8.1 Operation Manual Function Blocks/Structured Text	W447	Explains how to use the CX-Programmer Ver. 8.1 software's function block and structured text functions. For explanations of other CX-Programmer functions, refer to the <i>CX-Programmer Operation Manual</i> (W446).

Ethernet Functional Element

As shown in the following table, the Ethernet functional element supports the FINS communications service, FTP server function, and automatic clock adjustment function. Socket services and mail send/receive functions are not supported.

Item	CJ-series Ethernet Unit	CJ1M CPU Unit with Ethernet Function
	CJ1W-ETN21	CJ1M-CPU11-ETN CJ1M-CPU12-ETN CJ1M-CPU13-ETN
Socket services	Supported.	Not supported.
Mail send function		Supported.
Mail receive function		
FINS communications service		
FTP server function		
Automatic clock adjustment function		
Web function		

IP addresses, starting Ethernet communications, and other basic functions and operations, the FINS communications service, FTP server function, and automatic clock adjustment function are the same

as the CJ1W-ETN21 CJ-series Ethernet Unit. Therefore, refer to the following CJ-series CJ1W-ETN21 Ethernet Units operation manuals for details on the Ethernet functional element.

Manual No.	Models	Manual name	Contents
W420	CS1W-ETN21 CJ1W-ETN21	Ethernet Units Operation Manual Construction of Networks	Provides information on operating and installing 100Base-TX Ethernet Units, including details on basic settings and FINS communications. Refer to the <i>Communications Commands Reference Manual</i> (W342) for details on FINS commands that can be sent to CS-series and CJ-series CPU Units when using the FINS communications service.
W421	CS1W-ETN21 CJ1W-ETN21	Ethernet Units Operation Manual Construction of Applications	Provides information on constructing host applications for 100Base-TX Ethernet Units, including functions for sending/receiving mail, socket service, automatic clock adjustment, FTP server functions, and FINS communications.

The following table shows the relevant sections in the above manuals according to the information required.

Item		Relevant sections	
Basic functions and operations	Laying, connecting, and setting networks, etc.	Ethernet Units Operation Manual Construction of Networks (W420)	Section 2 <i>Installation and Initial Setup</i>
	Troubleshooting, etc.		Section 8 <i>Troubleshooting</i>
	Other		Section 1 <i>Features and System Configuration</i> Appendices A to G.
Communications services	FINS communications service	Ethernet Units Operation Manual Construction of Networks (W420)	Section 5 <i>Determining IP Addresses</i> Section 6 <i>FINS Communications</i>
			Ethernet Units Operation Manual Construction of Applications (W421)
	FTP server function	Section 4 <i>FTP Server</i>	
Automatic clock adjustment function	Section 5 <i>Automatic Clock Adjustment Function</i>		

Note The above Ethernet Unit manuals do not contain descriptions of Ethernet functional elements or CJ1M CPU Units with Ethernet Functions. Therefore, read Ethernet Unit as Ethernet functional element and CJ1W-ETN21 as CJ1M-CPU1□-ETN when referring to these manuals.

Read and Understand this Manual

Please read and understand this manual before using the product. Please consult your OMRON representative if you have any questions or comments.

Warranty and Limitations of Liability

WARRANTY

OMRON's exclusive warranty is that the products are free from defects in materials and workmanship for a period of one year (or other period if specified) from date of sale by OMRON.

OMRON MAKES NO WARRANTY OR REPRESENTATION, EXPRESS OR IMPLIED, REGARDING NON-INFRINGEMENT, MERCHANTABILITY, OR FITNESS FOR PARTICULAR PURPOSE OF THE PRODUCTS. ANY BUYER OR USER ACKNOWLEDGES THAT THE BUYER OR USER ALONE HAS DETERMINED THAT THE PRODUCTS WILL SUITABLY MEET THE REQUIREMENTS OF THEIR INTENDED USE. OMRON DISCLAIMS ALL OTHER WARRANTIES, EXPRESS OR IMPLIED.

LIMITATIONS OF LIABILITY

OMRON SHALL NOT BE RESPONSIBLE FOR SPECIAL, INDIRECT, OR CONSEQUENTIAL DAMAGES, LOSS OF PROFITS OR COMMERCIAL LOSS IN ANY WAY CONNECTED WITH THE PRODUCTS, WHETHER SUCH CLAIM IS BASED ON CONTRACT, WARRANTY, NEGLIGENCE, OR STRICT LIABILITY.

In no event shall the responsibility of OMRON for any act exceed the individual price of the product on which liability is asserted.

IN NO EVENT SHALL OMRON BE RESPONSIBLE FOR WARRANTY, REPAIR, OR OTHER CLAIMS REGARDING THE PRODUCTS UNLESS OMRON'S ANALYSIS CONFIRMS THAT THE PRODUCTS WERE PROPERLY HANDLED, STORED, INSTALLED, AND MAINTAINED AND NOT SUBJECT TO CONTAMINATION, ABUSE, MISUSE, OR INAPPROPRIATE MODIFICATION OR REPAIR.

Application Considerations

SUITABILITY FOR USE

OMRON shall not be responsible for conformity with any standards, codes, or regulations that apply to the combination of products in the customer's application or use of the products.

At the customer's request, OMRON will provide applicable third party certification documents identifying ratings and limitations of use that apply to the products. This information by itself is not sufficient for a complete determination of the suitability of the products in combination with the end product, machine, system, or other application or use.

The following are some examples of applications for which particular attention must be given. This is not intended to be an exhaustive list of all possible uses of the products, nor is it intended to imply that the uses listed may be suitable for the products:

- Outdoor use, uses involving potential chemical contamination or electrical interference, or conditions or uses not described in this manual.
- Nuclear energy control systems, combustion systems, railroad systems, aviation systems, medical equipment, amusement machines, vehicles, safety equipment, and installations subject to separate industry or government regulations.
- Systems, machines, and equipment that could present a risk to life or property.

Please know and observe all prohibitions of use applicable to the products.

NEVER USE THE PRODUCTS FOR AN APPLICATION INVOLVING SERIOUS RISK TO LIFE OR PROPERTY WITHOUT ENSURING THAT THE SYSTEM AS A WHOLE HAS BEEN DESIGNED TO ADDRESS THE RISKS, AND THAT THE OMRON PRODUCTS ARE PROPERLY RATED AND INSTALLED FOR THE INTENDED USE WITHIN THE OVERALL EQUIPMENT OR SYSTEM.

PROGRAMMABLE PRODUCTS

OMRON shall not be responsible for the user's programming of a programmable product, or any consequence thereof.

Disclaimers

CHANGE IN SPECIFICATIONS

Product specifications and accessories may be changed at any time based on improvements and other reasons.

It is our practice to change model numbers when published ratings or features are changed, or when significant construction changes are made. However, some specifications of the products may be changed without any notice. When in doubt, special model numbers may be assigned to fix or establish key specifications for your application on your request. Please consult with your OMRON representative at any time to confirm actual specifications of purchased products.

DIMENSIONS AND WEIGHTS

Dimensions and weights are nominal and are not to be used for manufacturing purposes, even when tolerances are shown.

PERFORMANCE DATA

Performance data given in this manual is provided as a guide for the user in determining suitability and does not constitute a warranty. It may represent the result of OMRON's test conditions, and the users must correlate it to actual application requirements. Actual performance is subject to the OMRON Warranty and Limitations of Liability.

ERRORS AND OMISSIONS

The information in this manual has been carefully checked and is believed to be accurate; however, no responsibility is assumed for clerical, typographical, or proofreading errors, or omissions.

PRECAUTIONS

This section provides general precautions for using the CJ-series Programmable Controllers (PLCs) and related devices.

The information contained in this section is important for the safe and reliable application of Programmable Controllers. You must read this section and understand the information contained before attempting to set up or operate a PLC system.

1	Intended Audience	xxiv
2	General Precautions	xxiv
3	Safety Precautions	xxiv
4	Operating Environment Precautions	xxvi
5	Application Precautions	xxvii
6	Conformance to EC Directives	xxx
6-1	Applicable Directives	xxx
6-2	Concepts	xxx
6-3	Conformance to EC Directives	xxxi
6-4	Relay Output Noise Reduction Methods	xxxi

1 Intended Audience

This manual is intended for the following personnel, who must also have knowledge of electrical systems (an electrical engineer or the equivalent).

- Personnel in charge of installing FA systems.
- Personnel in charge of designing FA systems.
- Personnel in charge of managing FA systems and facilities.

2 General Precautions

The user must operate the product according to the performance specifications described in the operation manuals.

Before using the product under conditions which are not described in the manual or applying the product to nuclear control systems, railroad systems, aviation systems, vehicles, combustion systems, medical equipment, amusement machines, safety equipment, and other systems, machines, and equipment that may have a serious influence on lives and property if used improperly, consult your OMRON representative.

Make sure that the ratings and performance characteristics of the product are sufficient for the systems, machines, and equipment, and be sure to provide the systems, machines, and equipment with double safety mechanisms.

This manual provides information for programming and operating the Unit. Be sure to read this manual before attempting to use the Unit and keep this manual close at hand for reference during operation.









 **WARNING** It is extremely important that a PLC and all PLC Units be used for the specified purpose and under the specified conditions, especially in applications that can directly or indirectly affect human life. You must consult with your OMRON representative before applying a PLC System to the above-mentioned applications.

3 Safety Precautions

 **WARNING** The CPU functional element refreshes I/O even when the program is stopped (i.e., even in PROGRAM mode). Confirm safety thoroughly in advance before changing the status of any part of memory allocated to I/O Units, Special I/O Units, or CPU Bus Units. Any changes to the data allocated to any Unit may result in unexpected operation of the loads connected to the Unit. Any of the following operation may result in changes to memory status.

- Transferring I/O memory data to the CPU functional element from a Programming Device.
- Changing present values in memory from a Programming Device.
- Force-setting/-resetting bits from a Programming Device.
- Transferring I/O memory files from a Memory Card or EM file memory to the CPU functional element.
- Transferring I/O memory from a host computer or from another PLC on a network.

 **WARNING** Do not attempt to take any Unit apart while the power is being supplied. Doing so may result in electric shock.

-  **WARNING** Do not touch any of the terminals or terminal blocks while the power is being supplied. Doing so may result in electric shock.
-  **WARNING** Do not attempt to disassemble, repair, or modify any Units. Any attempt to do so may result in malfunction, fire, or electric shock.
-  **WARNING** Do not touch the Power Supply Unit while power is being supplied or immediately after power has been turned OFF. Doing so may result in electric shock.
-  **WARNING** Provide safety measures in external circuits (i.e., not in the Programmable Controller), including the following items, to ensure safety in the system if an abnormality occurs due to malfunction of the PLC or another external factor affecting the PLC operation. Not doing so may result in serious accidents.
- Emergency stop circuits, interlock circuits, limit circuits, and similar safety measures must be provided in external control circuits.
 - The PLC will turn OFF all outputs when its self-diagnosis function detects any error or when a severe failure alarm (FALS) instruction is executed. Unexpected operation, however, may still occur for errors in the I/O control section, errors in I/O memory, and other errors that cannot be detected by the self-diagnosis function. As a countermeasure for all such errors, external safety measures must be provided to ensure safety in the system.
 - The PLC outputs may remain ON or OFF due to deposition or burning of the output relays or destruction of the output transistors. As a countermeasure for such problems, external safety measures must be provided to ensure safety in the system.
 - When the 24-V DC output (service power supply to the PLC) is overloaded or short-circuited, the voltage may drop and result in the outputs being turned OFF. As a countermeasure for such problems, external safety measures must be provided to ensure safety in the system.
-  **Caution** Confirm safety before transferring data files stored in the file memory (Memory Card or EM file memory) to the I/O area (CIO) of the CPU functional element using a Programming Device. Otherwise, the devices connected to the Output Unit may malfunction regardless of the operation mode of the CPU functional element.
-  **Caution** Fail-safe measures must be taken by the customer to ensure safety in the event of incorrect, missing, or abnormal signals caused by broken signal lines, momentary power interruptions, or other causes. Serious accidents may result from abnormal operation if proper measures are not provided.
-  **Caution** Execute online edit only after confirming that no adverse effects will be caused by extending the cycle time. Otherwise, the input signals may not be readable.
-  **Caution** Confirm safety at the destination node before transferring a program to another node or changing contents of the I/O memory area. Doing either of these without confirming safety may result in injury.

 **Caution** Tighten the screws on the terminal block of the AC Power Supply Unit to the torque specified in the operation manual. The loose screws may result in burning or malfunction.

 **Caution** CJ1M CPU functional elements automatically back up the user program and parameter data to flash memory when these are written to the CPU functional element. I/O memory (including the DM, EM, and HR Areas), however, is not written to flash memory. The DM, EM, and HR Areas can be held during power interruptions with a battery. If there is a battery error, the contents of these areas may not be accurate after a power interruption. If the contents of the DM, EM, and HR Areas are used to control external outputs, prevent inappropriate outputs from being made whenever the Battery Error Flag (A40204) is ON. Areas such as the DM, EM, and HR Areas, the contents of which can be held during power interrupts, is backed up by a battery. If a battery error occurs, the contents of the areas that are set to be held may not be accurate even though a memory error will not occur to stop operation. If necessary for the safety of the system, take appropriate measures in the ladder program whenever the Battery Error Flag (A40204) turns ON, such as resetting the data in these areas.

4 Operating Environment Precautions

 **Caution** Do not operate the control system in the following locations:

- Locations subject to direct sunlight.
- Locations subject to temperatures or humidity outside the range specified in the specifications.
- Locations subject to condensation as the result of severe changes in temperature.
- Locations subject to corrosive or flammable gases.
- Locations subject to dust (especially iron dust) or salts.
- Locations subject to exposure to water, oil, or chemicals.
- Locations subject to shock or vibration.

 **Caution** Take appropriate and sufficient countermeasures when installing systems in the following locations:

- Locations subject to static electricity or other forms of noise.
- Locations subject to strong electromagnetic fields.
- Locations subject to possible exposure to radioactivity.
- Locations close to power supplies.

 **Caution** The operating environment of the PLC System can have a large effect on the longevity and reliability of the system. Improper operating environments can lead to malfunction, failure, and other unforeseeable problems with the PLC System. Be sure that the operating environment is within the specified conditions at installation and remains within the specified conditions during the life of the system.

5 Application Precautions

Observe the following precautions when using the PLC System.

- You must use the CX-Programmer (programming software that runs on Windows) if you need to program more than one task. A Programming Console can be used to program only one cyclic task plus interrupt tasks. A Programming Console can, however, be used to edit multitask programs originally created with the CX-Programmer.

 **WARNING** Always heed these precautions. Failure to abide by the following precautions could lead to serious or possibly fatal injury.

- Always connect to a ground of 100 Ω or less when installing the Units. Not connecting to a ground of 100 Ω or less may result in electric shock.
- A ground of 100 Ω or less must be installed when shorting the GR and LG terminals on the Power Supply Unit.
- Always turn OFF the power supply to the PLC before attempting any of the following. Not turning OFF the power supply may result in malfunction or electric shock.
 - Mounting or dismounting Power Supply Units, I/O Units, CPU Units, or any other Units.
 - Assembling the Units.
 - Setting DIP switches or rotary switches.
 - Connecting cables or wiring the system.
 - Connecting or disconnecting the connectors.

 **Caution** Failure to abide by the following precautions could lead to faulty operation of the PLC or the system, or could damage the PLC or PLC Units. Always heed these precautions.

- A CJ-series CPU Unit is shipped with the battery installed and the time already set on the internal clock. It is not necessary to clear memory or set the clock before application, as it is for the CS-series CPU Units.
- The user program and parameter area data in CJ1-H/CJ1M CPU functional elements is backed up in the built-in flash memory. The BKUP indicator will light on the front of the CPU Unit when the backup operation is in progress. Do not turn OFF the power supply to the CPU Unit when the BKUP indicator is lit. The data will not be backed up if power is turned OFF.
- If, when using a CJ-series CPU Unit, the PLC Setup is set to specify using the mode set on the Programming Console and a Programming Console is not connected, the CPU functional element will start in RUN mode. This is the default setting in the PLC Setup. (A CS1 CPU functional element will start in PROGRAM mode under the same conditions.)
- When creating an AUTOEXEC.IOM file from a Programming Device (a Programming Console or the CX-Programmer) to automatically transfer data at startup, set the first write address to D20000 and be sure that the size of data written does not exceed the size of the DM Area. When the data file is read from the Memory Card at startup, data will be written in the CPU functional element starting at D20000 even if another address was set when the AUTOEXEC.IOM file was created. Also, if the DM Area

is exceeded (which is possible when the CX-Programmer is used), the remaining data will be written to the EM Area.

- Always turn ON power to the PLC before turning ON power to the control system. If the PLC power supply is turned ON after the control power supply, temporary errors may result in control system signals because the output terminals on DC Output Units and other Units will momentarily turn ON when power is turned ON to the PLC.
- Fail-safe measures must be taken by the customer to ensure safety in the event that outputs from Output Units remain ON as a result of internal circuit failures, which can occur in relays, transistors, and other elements.
- Fail-safe measures must be taken by the customer to ensure safety in the event of incorrect, missing, or abnormal signals caused by broken signal lines, momentary power interruptions, or other causes.
- Interlock circuits, limit circuits, and similar safety measures in external circuits (i.e., not in the Programmable Controller) must be provided by the customer.
- Do not turn OFF the power supply to the PLC when data is being transferred. In particular, do not turn OFF the power supply when reading or writing a Memory Card. Also, do not remove the Memory Card when the BUSY indicator is lit. To remove a Memory Card, first press the memory card power supply switch and then wait for the BUSY indicator to go out before removing the Memory Card.
- If the I/O Hold Bit is turned ON, the outputs from the PLC will not be turned OFF and will maintain their previous status when the PLC is switched from RUN or MONITOR mode to PROGRAM mode. Make sure that the external loads will not produce dangerous conditions when this occurs. (When operation stops for a fatal error, including those produced with the FALS(007) instruction, all outputs from Output Unit will be turned OFF and only the internal output status will be maintained.)
- The contents of the DM, EM, and HR Areas in the CPU functional element are backed up by a Battery. If the Battery voltage drops, this data may be lost. Provide countermeasures in the program using the Battery Error Flag (A40204) to re-initialize data or take other actions if the Battery voltage drops.
- Always use the power supply voltages specified in the operation manuals. An incorrect voltage may result in malfunction or burning.
- Take appropriate measures to ensure that the specified power with the rated voltage and frequency is supplied. Be particularly careful in places where the power supply is unstable. An incorrect power supply may result in malfunction.
- Install external breakers and take other safety measures against short-circuiting in external wiring. Insufficient safety measures against short-circuiting may result in burning.
- Do not apply voltages to the Input Units in excess of the rated input voltage. Excess voltages may result in burning.
- Do not apply voltages or connect loads to the Output Units in excess of the maximum switching capacity. Excess voltage or loads may result in burning.
- Disconnect the power supply's line ground terminal from the functional ground terminal when performing insulation resistance or withstand voltage tests. Not doing so may result in burning.

- Install the Units properly as specified in the operation manuals. Improper installation of the Units may result in malfunction.
- Be sure that all the terminal screws, and cable connector screws are tightened to the torque specified in the relevant manuals. Incorrect tightening torque may result in malfunction.
- Leave the label attached to the Unit when wiring. Removing the label may result in malfunction if foreign matter enters the Unit.
- Remove the label after the completion of wiring to ensure proper heat dissipation. Leaving the label attached may result in malfunction.
- Use crimp terminals for wiring. Do not connect bare stranded wires directly to terminals. Connection of bare stranded wires may result in burning.
- Wire all connections correctly.
- Double-check all wiring and switch settings before turning ON the power supply. Incorrect wiring may result in burning.
- Mount Units only after checking terminal blocks and connectors completely.
- Be sure that the terminal blocks, Memory Units, expansion cables, and other items with locking devices are properly locked into place. Improper locking may result in malfunction.
- Check switch settings, the contents of the DM Area, and other preparations before starting operation. Starting operation without the proper settings or data may result in an unexpected operation.
- Check the user program for proper execution before actually running it on the Unit. Not checking the program may result in an unexpected operation.
- Confirm that no adverse effect will occur in the system before attempting any of the following. Not doing so may result in an unexpected operation.
 - Changing the operating mode of the PLC (including the setting of the startup operating mode).
 - Force-setting/force-resetting any bit in memory.
 - Changing the present value of any word or any set value in memory.
- Resume operation only after transferring to the new CPU functional element the contents of the DM Area, HR Area, and other data required for resuming operation. Not doing so may result in an unexpected operation.
- Do not pull on the cables or bend the cables beyond their natural limit. Doing either of these may break the cables.
- Do not place objects on top of the cables or other wiring lines. Doing so may break the cables.
- Do not use commercially available RS-232C personal computer cables. Always use the special cables listed in this manual or make cables according to manual specifications. Using commercially available cables may damage the external devices or CPU Unit.
- Do not connect pin 6 (+5 V power supply line) of the RS-232C port on the CPU Unit to any external device except the CJ1W-CIF11 RS-422A Adapter or NT-AL001 RS-232C/RS-422A Adapter. Doing so may damage the external device or CPU Unit.
- When replacing parts, be sure to confirm that the rating of a new part is correct. Not doing so may result in malfunction or burning.

- Before touching a Unit, be sure to first touch a grounded metallic object in order to discharge any static build-up. Not doing so may result in malfunction or damage.
- When transporting or storing circuit boards, cover them in antistatic material to protect them from static electricity and maintain the proper storage temperature.
- Do not touch circuit boards or the components mounted to them with your bare hands. There are sharp leads and other parts on the boards that may cause injury if handled improperly.
- Do not short the battery terminals or charge, disassemble, heat, or incinerate the battery. Do not subject the battery to strong shocks. Doing any of these may result in leakage, rupture, heat generation, or ignition of the battery. Dispose of any battery that has been dropped on the floor or otherwise subjected to excessive shock. Batteries that have been subjected to shock may leak if they are used.
- UL standards required that batteries be replaced only by experienced technicians. Do not allow unqualified persons to replace batteries.
- After connecting Power Supply Units, CPU Units, I/O Units, Special I/O Units, or CPU Bus Units together, secure the Units by sliding the sliders at the top and bottom of the Units until they click into place. Correct operation may not be possible if the Units are not securely properly. Be sure to attach the end cover provided with the CPU Unit to the rightmost Unit. CJ-series PLCs will not operate properly if the end cover is not attached.
- Unexpected operation may result if inappropriate data link tables or parameters are set. Even if appropriate data link tables and parameters have been set, confirm that the controlled system will not be adversely affected before starting or stopping data links.
- CPU Bus Units will be restarted when routing tables are transferred from a Programming Device to the CPU functional element. Restarting these Units is required to read and enable the new routing tables. Confirm that the system will not be adversely affected before allowing the CPU Bus Units to be reset.

6 Conformance to EC Directives

6-1 Applicable Directives

- EMC Directives
- Low Voltage Directive

6-2 Concepts

EMC Directives

OMRON devices that comply with EC Directives also conform to the related EMC standards so that they can be more easily built into other devices or the overall machine. The actual products have been checked for conformity to EMC standards (see the following note). Whether the products conform to the standards in the system used by the customer, however, must be checked by the customer.

EMC-related performance of the OMRON devices that comply with EC Directives will vary depending on the configuration, wiring, and other conditions of the equipment or control panel on which the OMRON devices are installed. The customer must, therefore, perform the final check to confirm that devices and the overall machine conform to EMC standards.

Note Applicable EMC (Electromagnetic Compatibility) standards are as follows:

EMS (Electromagnetic Susceptibility): EN61000-6-2
EMI (Electromagnetic Interference): EN61000-6-4
(Radiated emission: 10-m regulations)

Low Voltage Directive

Always ensure that devices operating at voltages of 50 to 1,000 V AC and 75 to 1,500 V DC meet the required safety standards for the PLC (EN61131-2).

6-3 Conformance to EC Directives

The CJ-series PLCs comply with EC Directives. To ensure that the machine or device in which the CJ-series PLC is used complies with EC Directives, the PLC must be installed as follows:

- 1,2,3...**
1. The CJ-series PLC must be installed within a control panel.
 2. You must use reinforced insulation or double insulation for the DC power supplies used for the communications power supply and I/O power supplies.
 3. CJ-series PLCs complying with EC Directives also conform to the Common Emission Standard (EN61000-6-4). Radiated emission characteristics (10-m regulations) may vary depending on the configuration of the control panel used, other devices connected to the control panel, wiring, and other conditions. You must therefore confirm that the overall machine or equipment complies with EC Directives.

6-4 Relay Output Noise Reduction Methods

The CJ-series PLCs conforms to the Common Emission Standards (EN61000-6-4) of the EMC Directives. However, noise generated by relay output switching may not satisfy these Standards. In such a case, a noise filter must be connected to the load side or other appropriate countermeasures must be provided external to the PLC.

Countermeasures taken to satisfy the standards vary depending on the devices on the load side, wiring, configuration of machines, etc. Following are examples of countermeasures for reducing the generated noise.

Countermeasures

(Refer to EN61000-6-4 for more details.)

Countermeasures are not required if the frequency of load switching for the whole system with the PLC included is less than 5 times per minute.

Countermeasures are required if the frequency of load switching for the whole system with the PLC included is more than 5 times per minute.

Countermeasure Examples

When switching an inductive load, connect an surge protector, diodes, etc., in parallel with the load or contact as shown below.

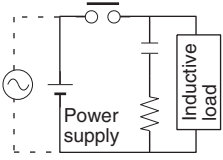
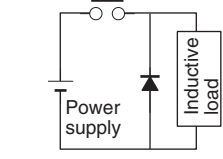
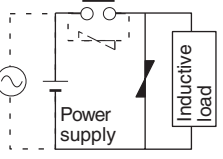
Circuit	Current		Characteristic	Required element
	AC	DC		
<p>CR method</p> 	Yes	Yes	<p>If the load is a relay or solenoid, there is a time lag between the moment the circuit is opened and the moment the load is reset.</p> <p>If the supply voltage is 24 or 48 V, insert the surge protector in parallel with the load. If the supply voltage is 100 to 200 V, insert the surge protector between the contacts.</p>	<p>The capacitance of the capacitor must be 1 to 0.5 μF per contact current of 1 A and resistance of the resistor must be 0.5 to 1 Ω per contact voltage of 1 V. These values, however, vary with the load and the characteristics of the relay. Decide these values from experiments, and take into consideration that the capacitance suppresses spark discharge when the contacts are separated and the resistance limits the current that flows into the load when the circuit is closed again.</p> <p>The dielectric strength of the capacitor must be 200 to 300 V. If the circuit is an AC circuit, use a capacitor with no polarity.</p>
<p>Diode method</p> 	No	Yes	<p>The diode connected in parallel with the load changes energy accumulated by the coil into a current, which then flows into the coil so that the current will be converted into Joule heat by the resistance of the inductive load.</p> <p>This time lag, between the moment the circuit is opened and the moment the load is reset, caused by this method is longer than that caused by the CR method.</p>	<p>The reversed dielectric strength value of the diode must be at least 10 times as large as the circuit voltage value. The forward current of the diode must be the same as or larger than the load current.</p> <p>The reversed dielectric strength value of the diode may be two to three times larger than the supply voltage if the surge protector is applied to electronic circuits with low circuit voltages.</p>
<p>Varistor method</p> 	Yes	Yes	<p>The varistor method prevents the imposition of high voltage between the contacts by using the constant voltage characteristic of the varistor. There is time lag between the moment the circuit is opened and the moment the load is reset.</p> <p>If the supply voltage is 24 or 48 V, insert the varistor in parallel with the load. If the supply voltage is 100 to 200 V, insert the varistor between the contacts.</p>	---

When switching a load with a high inrush current such as an incandescent lamp, suppress the inrush current as shown below.

Countermeasure 1

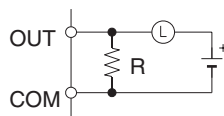

Providing a dark current of approx. one-third of the rated value through an incandescent lamp

Countermeasure 2

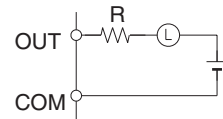

Providing a limiting resistor

SECTION 1

Introduction and Specifications

This section introduces the special features, functions, and specifications of the CJ1M CPU Units with Ethernet Functions and describes the differences between the Ethernet functional element incorporated into the CPU Unit and separate Ethernet Units.

1-1	Introduction.....	2
1-1-1	Overview	2
1-1-2	Features.....	2
1-2	Specifications	3
1-2-1	Performance Specifications	3
1-2-2	Comparison between Ethernet Functional Elements and Ethernet Units.....	5
1-3	Part Names and Dimensions.....	7
1-3-1	Part Names	7

1-1 Introduction

1-1-1 Overview

The CJ1M CPU Units with Ethernet Functions combine the high-speed, large-capacity, multifunctional capabilities of the SYSMAC CJ-series CPU Unit in a micro PLC with the functionality of an Ethernet Unit.

Note The Ethernet functional element is part of the CPU Unit and cannot be removed.

The CJ1M-CPU1□-ETN incorporates a CPU functional element combined with an Ethernet functional element. The CPU functional element has the same functionality as a CJ1M-CPU1□ CJ1M CPU Unit (without built-in I/O) with unit version 3.0 or later. The Ethernet functional element provides the main functions of the CJ1W-ETN21 Ethernet Unit.

Product name	Product model number	Configuration	
		CPU functional element	Ethernet functional element
		CPU Unit with same functionality	Ethernet Unit with similar functionality
CPU Unit with Ethernet Functions	CJ1M-CPU11-ETN	CJ1M-CPU11	CJ1W-ETN21
	CJ1M-CPU12-ETN	CJ1M-CPU12	
	CJ1M-CPU13-ETN	CJ1M-CPU13	

CPU Functional Element

Model	Program capacity	I/O points	Data Memory	Expansion Racks
CJ1M-CPU11-ETN	5 Ksteps	160 points	32 Kwords (No Extended Data Memory)	None
CJ1M-CPU12-ETN	10 Ksteps	320 points		
CJ1M-CPU13-ETN	20 Ksteps	640 points		1 max.

Note Details on the CPU Functional Element are not provided in this manual. Refer to the *CJ1M CPU Unit Operation Manual*.

Ethernet Functional Element

Model	Physical layer	Maximum number of nodes in FINS network	Communications service
CJ1M-CPU11-ETN	100BASE-TX, 10BASE-T	254	<ul style="list-style-type: none"> • FINS communications service • FTP server • Automatically adjusted clock information. • Web functions
CJ1M-CPU12-ETN			
CJ1M-CPU13-ETN			

1-1-2 Features

- The CPU functional element has the functionality of a CJ1M CPU Unit without built-in I/O.
- The CPU Unit supports FINS communications services, FTP services, and automatic clock adjustment, without requiring installation of a separate Ethernet Unit.

Note Socket services and sending/receiving mail are not supported.

- The unit settings and status monitoring of the Ethernet functional element can be performed from the Web browser.

1-2 Specifications

1-2-1 Performance Specifications

CPU Functional Element

Item		Specification		
Model		CJ1M-CPU13-ETN	CJ1M-CPU12-ETN	CJ1M-CPU11-ETN
Functional element version		Ver. 3.0 or later		
I/O points		640	320	160
User program memory		20 Ksteps	10 Ksteps	5 Ksteps
Maximum number of Expansion Racks		1 max.	Not supported.	
CJ-series Basic I/O Units CJ-series Special I/O Units CJ-series CPU Bus Units		Total: 9 + 10 Units max. (CPU Rack: 9 Units Expansion Rack: 10 Units)	Total: 9 Units max.	
Data Memory		32 Kwords		
Extended Data Memory		Not supported.		
Pulse functions		Not supported.		
Interrupt inputs		2	1	
PWM output points		None		
Maximum subroutine number		1,024	256	
Maximum jump number for JMP instruction		1,024	256	
Function blocks (FB)	Maximum number of definitions	128		
	Maximum number of instances	256		
Flash memory	Function block program memory	256 Kbytes		
	Comment file	64 Kbytes		
	Program index file	64 Kbytes		
	Symbol tables	64 Kbytes		

Ethernet Functional Element Transfer Specifications

Item		Specification	
Functional element version		Ver. 1.0 or later	
Media access method		CSMA/CD	
Modulation method		Baseband	
Transmission paths		Star form	
Baud rate		100 Mbit/s (100Base-TX)	10 Mbit/s (10Base-TX)
Transmission media		Unshielded twisted-pair (UDP) cable Categories: 5, 5e Shielded twisted-pair (STP) cable Categories: 100 Ω at 5, 5e	Unshielded twisted-pair (UDP) cable Categories: 3, 4, 5, 5e Shielded twisted-pair (STP) cable Categories: 100 Ω at 3, 4, 5, 5e
Transmission distance		100 m (distance between hub and node)	
Number of cascade connections		No restrictions if switching hubs are used.	
CPU Bus Unit System Setup Area capacity		994 bytes (See note 2.)	

Common Specifications

Item	Specification
Current consumption (supplied by Power Supply Units)	0.95 A at 5 VDC
Noise immunity	2 kV on power supply line (conforming to IEC61000-4-4)
Vibration resistance	10 to 57 Hz, 0.075-mm amplitude, 57 to 150 Hz, acceleration: 9.8 m/s ² in X, Y, and Z directions for 80 minutes (Time coefficient: 8 minutes × coefficient factor 10 = total time 80 min.) (according to JIS C0040)
Shock resistance	147 m/s ² 3 times each in X, Y, and Z directions (Relay Output Unit: 100 m/s ²) (according to JIS C0041)
Ambient operating temperature	0 to 55°C
Ambient operating humidity	10% to 90% (with no condensation)
Atmosphere	Must be free from corrosive gases.
Ambient storage temperature	−20 to 75°C (excluding battery)
Grounding	Less than 100 Ω
Enclosure	Mounted in a panel.
Weight (Unit only)	210 g max.
Dimensions	62 × 90 × 65 mm (W × H × D)
Safety measures	Conforms to cULus and EC Directives.

- Note**
1. The number of steps in a program is not the same as the number of instructions. For example, LD and OUT require 1 step each, but MOV(021) requires 3 steps. The program capacity indicates the total number of steps for all instructions in the program. For details, refer to the *SYSMAC CJ-series Programmable Controllers Operation Manual (W393)* for the number of steps required for each instruction.
 2. The Ethernet functional element in the CJ1M CPU Unit with Ethernet Functions is also allocated in the CPU Bus Unit System Setup Area.

Dimensions (Same for All Units)

Front

Version 1.5 or Higher

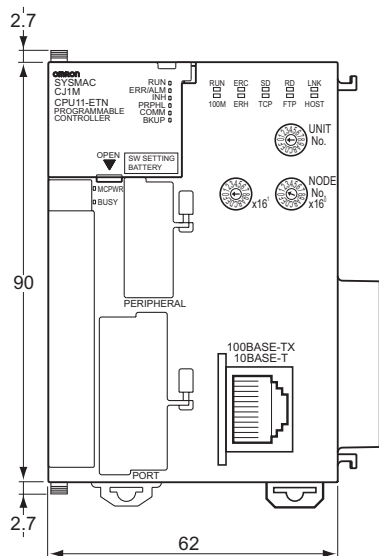

Version 1.4 or Lower

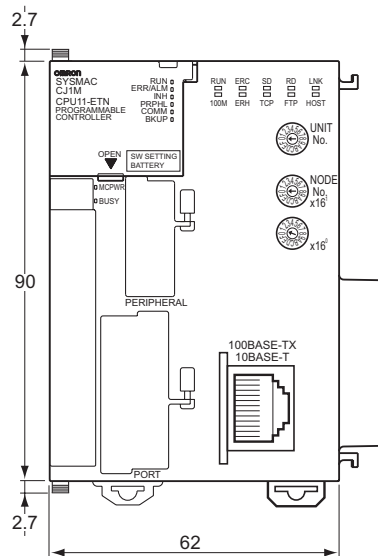

Side

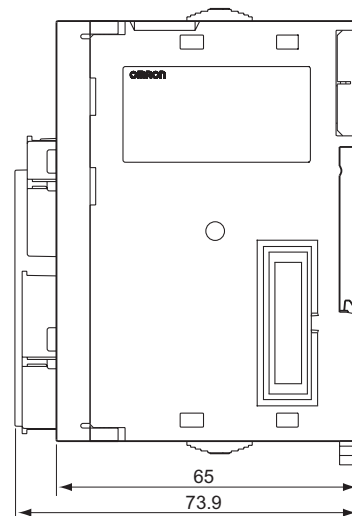

1-2-2 Comparison between Ethernet Functional Elements and Ethernet Units

The following table shows the differences between CJ1M CPU Units with Ethernet Functions and CJ-series Ethernet Units.

Item	CJ-series Ethernet Unit	CJ1M CPU Units with Ethernet Functions
Model number	CJ1W-ETN21	CJ1M-CPU11-ETN CJ1M-CPU12-ETN CJ1M-CPU13-ETN
Physical layer	100BASE-TX, 10BASE-T	Same
Number of nodes on FINS network	254	Same
Removing Ethernet functional element	Possible	Not possible
Server specification	Specification by IP address or host name specifications (DNS client function)	Same

Item		CJ-series Ethernet Unit	CJ1M CPU Units with Ethernet Functions	
Communications service	FINS communications service	FINS/UDP FINS/TCP	Same	
	FTP server function	The CPU Unit's file memory (Memory Card or EM file memory) can be read/written.	The CPU functional element's file memory (Memory Card only) can be read/written.	
	Automatic clock information adjustment	The CPU Unit's internal clock data can be automatically adjusted to the clock data received from the SNTP server	Same	
	Web functions	The Unit settings can be made and status can be read from a Web browser using the Web server.	Same	
	Mail functions	Mail send functions Mail receive functions	Not possible	
	Socket service function	TCP socket services UDP socket services	Not possible	
	FINS commands	RESET		Same
		CONTROLLER DATA READ		Same Responds to CJ1W-ETN21
		CONTROLLER STATUS READ		Same
		ECHOBACK TEST		Same
		BROADCAST TEST (READ RESULTS)		Same
		BROADCAST TEST (SEND TEST DATA)		Same
		ERROR LOG READ		Same
		ERROR LOG CLEAR		Same
		REQUEST TO OPEN UDP SOCKET		Not possible
		REQUEST TO RECEIVE UDP SOCKET		Not possible
		REQUEST TO SEND UDP SOCKET		Not possible
		REQUEST TO CLOSE UDP SOCKET		Not possible
		REQUEST TO OPEN TCP SOCKET (PASSIVE)		Not possible
		REQUEST TO OPEN TCP SOCKET (ACTIVE)		Not possible
		REQUEST TO RECEIVE TCP SOCKET		Not possible
		REQUEST TO SEND TCP SOCKET		Not possible
		REQUEST TO CLOSE TCP SOCKET		Not possible
		EXECUTE PING COMMAND		Same
		REQUEST TO CHANGE REMOTE NODE FOR FINS/TCP CONNECTION		Same
		REQUEST TO READ STATUS FOR FINS/TCP CONNECTION		Same
		IP ADDRESS TABLE WRITE		Same
		IP ADDRESS WRITE		Same
		IP ADDRESS TABLE READ		Same
		IP ROUTING TABLE READ		Same
		PROTOCOL STATUS READ		Same
		MEMORY STATUS READ		Same
		SOCKET STATUS READ		Same
ADDRESS DATA READ		Same		
IP ADDRESS READ		Same		

1-3 Part Names and Dimensions

1-3-1 Part Names

Front

■ Version 1.4 or Lower

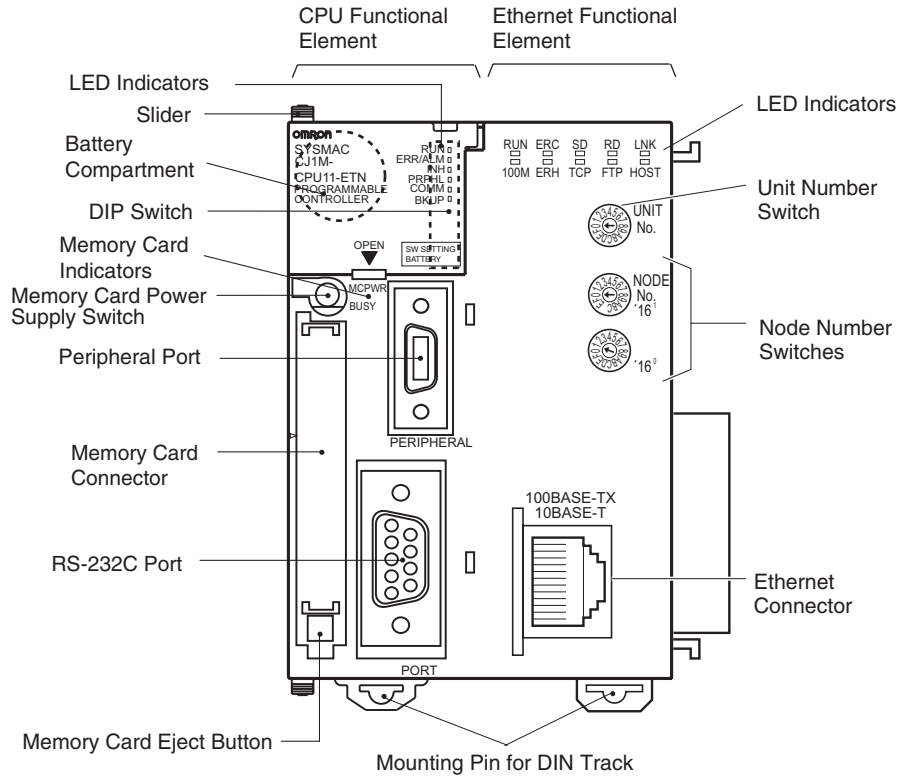

■ Version 1.5 or Higher

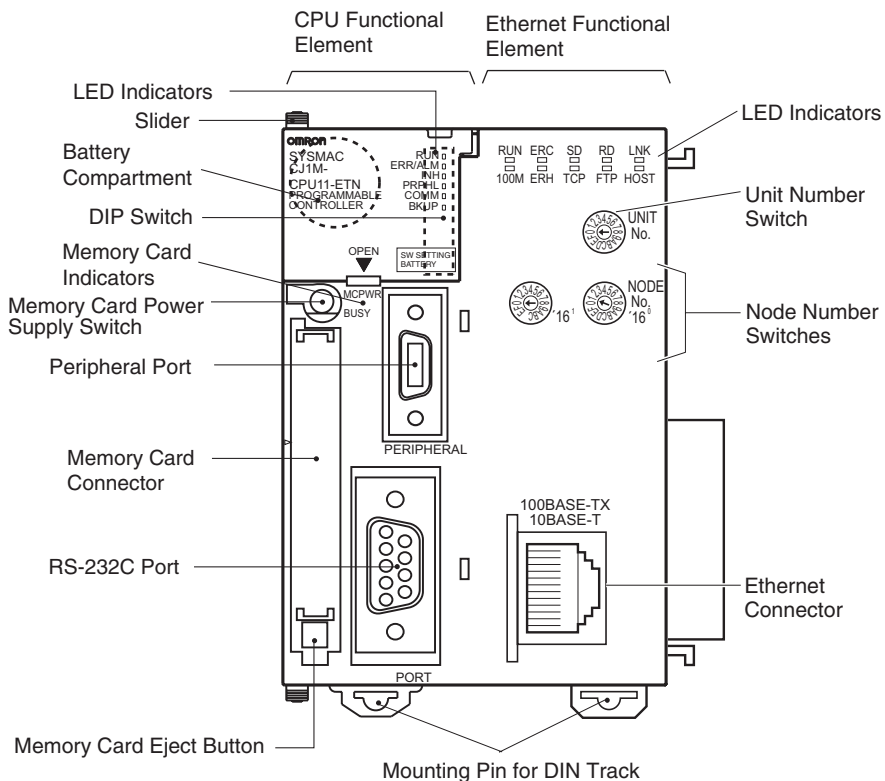

■ CPU Functional Element

Name	Description
LED indicators	Indicate the status of the CPU Functional Element. (Refer to <i>CPU Functional Element Indicators on page 10</i> for details.)
DIP switch	Sets initial settings for the CPU Functional Element.
Peripheral port	Connects to a computer running Support Software or a Programming Console.
Memory Card Indicators	MCPWR (green): Lit when power is supplied to Memory Card. BUSY (orange): Lit when Memory Card is being accessed.
Memory Card power supply switch	Stops the power supply to the Memory Card so that the Memory Card can be removed.
Memory Card connector	The connector where a Memory Card can be inserted. (The label on the Memory Card must face to the right.)
Memory Card eject button	Pressed to remove the Memory Card.
RS-232C port	Connects to a serial communications device.

■ Ethernet Functional Element

Name	Description
LED indicators	Indicate the status of the Ethernet Functional Element. (Refer to <i>Ethernet Functional Element Indicators on page 12</i> for details.)
Unit number switch	Sets the unit number for Ethernet functionality. Setting range: 0 to F hex
Node number switches	Set the FINS node address for Ethernet as a 2-digit hexadecimal number. Setting range: 01 to FE hex
Ethernet connector	Connects to Ethernet through a twisted-pair cable.
Sliders	Connect to and lock the adjacent Units.
Mounting pins for DIN Track	Used to mount and lock the Unit to a DIN Rack.

Note When you are not using the peripheral port or RS-232C port on the CPU Functional Element, cover it with the enclosed cover to protect it from dust.

CPU Functional Element Indicators

The following table describes the LED indicators located on the front panel of the CPU functional element.

Indicator	Color	Status	Meaning
RUN	Green	ON	PLC is operating normally in MONITOR or RUN mode.
		Flashing	System download mode error or DIP switch settings error.
		OFF	PLC has stopped operating while in PROGRAM mode, or has stopped operating due to a fatal error, or is downloading data from the system.
ERR/ALM	Red	ON	A fatal error has occurred (including FALS instruction execution), or a hardware error (watchdog timer error) has occurred. The CPU functional element will stop operating, and the outputs from all Output Units will turn OFF.
		Flashing	A non-fatal error has occurred (including FAL instruction execution) The CPU functional element will continue operating.
		OFF	CPU functional element is operating normally.
INH	Orange	ON	Output OFF Bit (A50015) has been turned ON. The outputs from all Output Units will turn OFF.
		OFF	Output OFF Bit (A50015) has been turned OFF.
PRPHL	Orange	Flashing	CPU functional element is communicating (sending or receiving) via the peripheral port.
		OFF	CPU functional element is not communicating via the peripheral port.
COMM	Orange	Flashing	CPU functional element is communicating (sending or receiving) via the RS-232C port.
		OFF	CPU functional element is not communicating via the RS-232C port.
BKUP	Orange	ON	User program and parameter area data is being backed up to flash memory in the CPU functional element or being restored from flash memory. Note Do not turn OFF the power supply to the PLC while this indicator is lit.
		OFF	Data is not being written to flash memory.

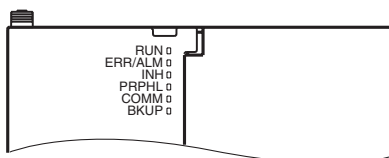

Indicator	Color	Status	Meaning
MCPWR	Green	ON	Power is being supplied to the Memory Card.
		Flashing	Flashes once: Easy backup read, write, or verify normal Flashes five times: Easy backup write malfunction Flashes three times: Easy backup write warning Flashes continuously: Easy backup read or verify malfunction
		OFF	Power is not being supplied to the Memory Card.
BUSY	Orange	Flashing	Memory Card is being accessed.
		OFF	Memory Card is not being accessed.

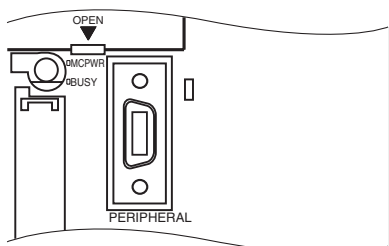

DIP Switch

The CJM1 CPU Unit with Ethernet Functions has an 8-pin DIP switch that is used to set basic operational parameters for the Unit, as shown in the following table.

Pin no.	Setting	Function	Usage	Default
1	ON	Writing disabled for user program memory. (See note.)	Used to prevent programs from being accidentally overwritten from Programming Devices (including Programming Console).	OFF
	OFF	Writing enabled for user program memory.		
2	ON	The user program is automatically transferred from the Memory Card when power is turned ON.	Used to store the programs in the Memory Card to switch operations, or to automatically transfer programs at power-up (Memory Card ROM operation). Note When pin 7 is ON and pin 8 is OFF, easy backup reading from the Memory Card is given priority, so even if pin 2 is ON, the user program is not automatically transferred from the Memory Card when power is turned ON.	OFF
	OFF	The user program is not automatically transferred from the Memory Card when power is turned ON.		
3	---	Not used.	---	OFF
4	ON	Peripheral port communications parameters set in the PLC Setup are used.	Turn ON to use the peripheral port for a device other than Programming Console or CX-Programmer (Peripheral bus only).	OFF
	OFF	Peripheral port communications parameters set using Programming Console or CX-Programmer (Peripheral bus only) are used.		
5	ON	RS-232C port communications parameters set using a CX-Programmer (Peripheral bus only) are used.	Turn ON to use the RS-232C port for a Programming Device.	OFF
	OFF	RS-232C port communications parameters set in the PLC Setup are used.		
6	ON	User-defined pin. Turns OFF the User DIP Switch Pin Flag (A39512).	Set pin 6 to ON or OFF and use A39512 in the program to create a user-defined condition without using an I/O Unit.	OFF
	OFF	User-defined pin. Turns ON the User DIP Switch Pin Flag (A39512).		
7	ON	Writing from the CPU functional element to the Memory Card.	Press and hold the Memory Card Power Supply Switch for three seconds.	OFF
		Restoring from the Memory Card to the CPU functional element.	To read from the Memory Card to the CPU functional element, turn ON the PLC power. This operation is given priority over automatic transfer (pin 2 is ON) when power is ON.	
	OFF	Verifying contents of Memory Card.	Press and hold the Memory Card Power Supply Switch for three seconds.	
8	OFF	Always OFF.		OFF

- Note**
- The following data cannot be overwritten when pin 1 is ON:
 - All parts of the user program (programs in all tasks)
 - All data in the parameter area (such as the PLC Setup and I/O table)

When pin 1 is ON, the user program and parameter area will not be cleared when the memory clear operation is performed from a Programming Device.
 - The CPU functional element will not enter any mode except PROGRAM mode after backing up data to a Memory Card using DIP switch pin 7. To enter RUN or MONITOR mode, turn OFF the power supply, turn OFF pin 7, and then restart the PLC. This will enable changing the operating mode as normal.

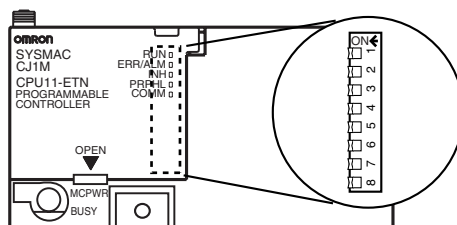

Note The language displayed for the CJ-series CPU Units is not set on the DIP switch, but rather is set using Programming Console keys.

Ethernet Functional Element Indicators

The status of the indicators show the operating status of the Ethernet functional element, as shown below.

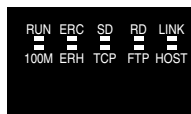

Indicator	Color	Status	Meaning
RUN	Green	Not lit	Operation stopped Hardware error
		Lit	Normal operation
100M (Transfer speed)	Green	Not lit	10 Mbps (10Base-T)
		Lit	100 Mbps (100Base-TX)
ERC (Ethernet functional element error)	Red	Not lit	Ethernet functional element normal
		Lit	Node address not between 1 and 254 A hardware (e.g., internal memory) error has occurred.
ERH (CPU functional element error)	Red	Not lit	CPU functional element normal
		Lit	An error has occurred at the CPU functional element. There is an error in the I/O table, unit number, unit setup, or routing table settings.
		Flashing	An illegal IP address has been set. With automatic address generation, the rightmost two digits of the IP address do not match the node address.
SD (Send Data)	Yellow	Not lit	Not sending data (ready to send)
		Lit	Sending data
RD (Receive Data)	Yellow	Not lit	Not receiving data (ready to receive)
		Lit	Receiving data
LNK (Link status)	Yellow	Not lit	Link not established between hubs.
		Lit	Link established between hubs.
TCP (TCP socket in use)	Yellow	Not lit	None of the eight TCP sockets provided for socket services is in use.
		Lit	At least one of the eight TCP sockets provided for socket services is in use.
FTP (FTP Server Service)	Yellow	Not lit	FTP server on standby.
		Lit	FTP server operating (one user connected).
HOST (Server connection status)	Yellow	Not lit	Server (DNS, SMTP, POP3, or SNTTP) not being used.
		Flashing	An error has occurred in the server connection.
		Lit	The server connection is normal.

Setting the Unit Number for the Ethernet Functional Element

The unit number is used to identify individual CPU Bus Units when more than one CPU Bus Unit is mounted to the same PLC. Use a small screwdriver to make the setting, taking care not to damage the rotary switch. The unit number is factory-set to 0.

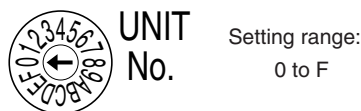

- Note**
1. Turn OFF the power supply before setting the unit number.
 2. If the unit number is being set for the first time or changed, then I/O tables must be created for the PLC.
 3. With CS-series and CJ-series PLCs, dedicated areas are automatically allocated in the CIO Area and DM Area according to the unit numbers that are set. For details, refer to *SECTION 4 Ethernet Unit Memory Allocations (W420)*.

Setting the Node Address for the Ethernet Functional Element

With the FINS communications service, when there are multiple Ethernet functional elements or Ethernet Units connected to the Ethernet network, the Ethernet functional elements and Ethernet Units are identified by node addresses. Use the node address switches to set the node address between 01 and FE hexadecimal (1 to 254 decimal). Do not set a number that has already been set for another node on the same network.

<p>Version 1.5 or Higher</p> <p>The left switch sets the sixteens digit (most significant digit) and the right switch sets the ones digit (least significant digit).</p>	<p>Version 1.4 or lower</p> <p>The top switch sets the sixteens digit (most significant digit) and the bottom switch sets the ones digit (least significant digit).</p>	<p>Setting range: 01 to FE (1 to 254 decimal) The node address is factory-set to 01.</p>
--	---	--

- Note** Turn OFF the power supply before setting the node address.

Relation to IP Addresses

When using the automatic generation method (either dynamic or passive) for address conversion, set the rightmost byte of the IP address set for the Ethernet functional elements or Ethernet Unit to the same value as the node address. If this is not possible, either the IP address table method or the combined method must be used for address conversion. (For details, refer to the *Ethernet Units Construction of Networks Operation Manual (W420)*.) If the FINS communications service is not used on the Ethernet network, then it is all right to overlap with other Ethernet functional elements or Ethernet Units. The setting, however, must be made within a range of 01 to FE. If a value outside of this range is set, the ERC indicator will light.

An IP address label is provided with the Ethernet functional element. Writing the IP address and the subnet mask on this label and then attaching it to the front of the Ethernet functional element allows the IP address and subnet mask to be easily confirmed.

Front of Ethernet Functional Element

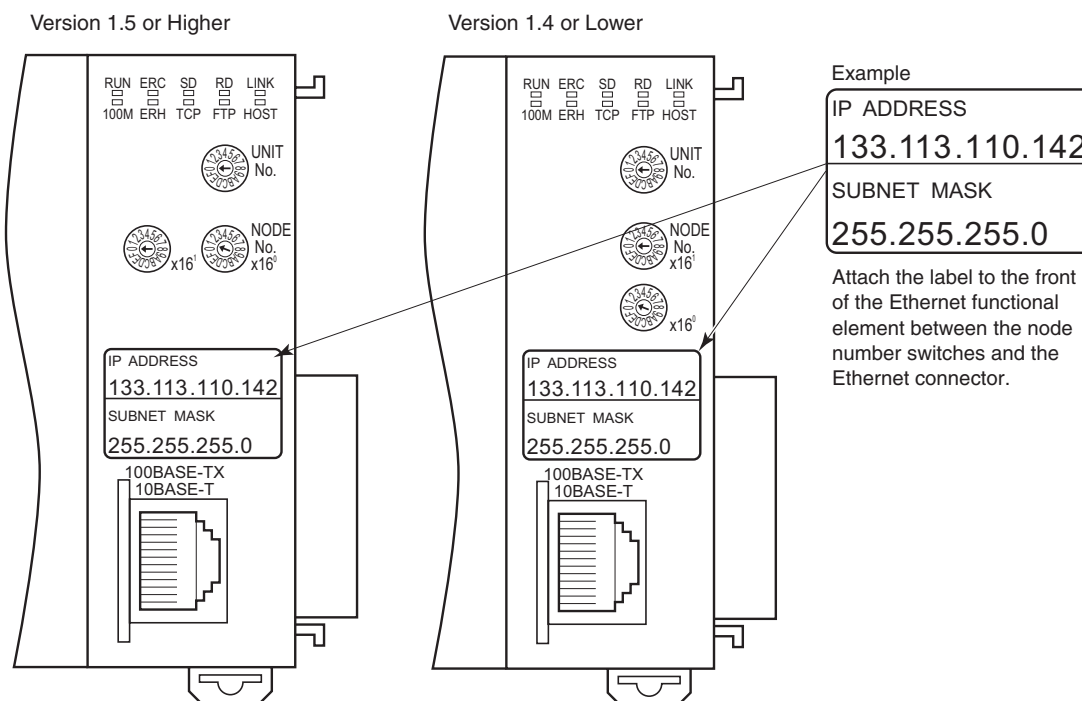

Example
 IP ADDRESS
 133.113.110.142
 SUBNET MASK
 255.255.255.0

Attach the label to the front of the Ethernet functional element between the node number switches and the Ethernet connector.

Each communications device connected to the Ethernet network is allocated a unique Ethernet address. For the Ethernet functional element, this Ethernet address is shown on the right side of the Unit as a 12-digit hexadecimal number.

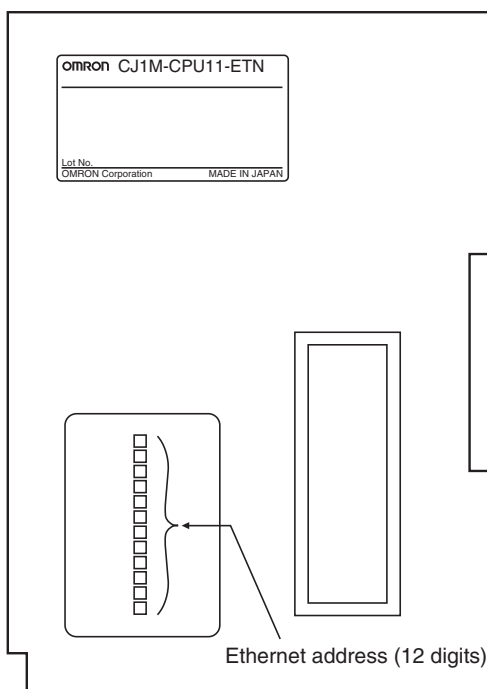

Note The Ethernet address can also be checked using the FINS command.

SECTION 2

Unit Setup and Memory Allocations

This section describes the settings made in the Unit Setup using either the CX-Programmer or Web function, and also provides information on memory allocations for the Ethernet functional element.

2-1	Unit Setup	16
2-1-1	Using the CX-Programmer	16
2-1-2	Using the Web Function	17
2-2	Ethernet Functional Element Memory Allocations	17
2-2-1	CIO Area Allocations	17
2-2-2	DM Area Allocations	21
2-3	Web Function	22

2-1 Unit Setup

Use either the Unit Setup in the CX-Programmer (Ver. 5.0 or later) or the Web function to set the Unit settings for the Ethernet functional element.

2-1-1 Using the CX-Programmer

The following table lists the Unit settings that can be made from the CX-Programmer. For details on Unit settings, refer to the *Ethernet Units Construction of Networks Operation Manual (W420)* and the *Ethernet Units Construction of Applications Operation Manual (W421)*.

Note The Ethernet functional elements use the same settings as for Ethernet Units. Therefore, all the Unit Setup settings for Ethernet Units are displayed, but some settings cannot be set when using the CPU Unit with Ethernet Functions.

Tab	Item		Default	
Setup	Broadcast		All 1 (4.3BSD)	
	IP Address		0.0.0.0 (FINS node address 192.168.250.)	
	Sub-net Mask		0.0.0.0 (default net mask for IP address setting)	
	Enable CIDR		Do not enable.	
	FINS/UDP Port		9,600	
	FINS/TCP Port		9,600	
	Conversion		Auto (dynamic)	
	TCP/IP keep-alive		0 (120 minutes)	
	IP Address Table		None	
	IP Router Table		None	
	FTP		Login	None
			Password	None ("CONFIDENTIAL")
		Port No.	0 (Number 21 is used.)	
High-speed socket service		This function cannot be used on CPU Units with Ethernet Functions. The setting will be saved, but it will be ignored in operation.	---	
FINS/TCP	Connection			
	The following settings can be made for each connection number.	FINS/TCP Mode	Server	
		IP Address	0.0.0.0	
		Auto allocated FINS node keep-alive	From 239 to 254, for connection Nos. 1 to 16 Use	
DNS	IP Address		None	
	Port No.		0 (Number 53 is used.)	
	Retry timer		0 (10 ms)	
SMTP	These functions are not supported for CJ1M CPU Units with Ethernet Functions.		---	
POP			---	
Mail Address	Note If any of these settings are made, the settings will be saved, but ignored by the system. Therefore, malfunctions will not occur.			---
Send Mail				---
Receive Mail				---

Tab	Item	Default
Auto Adjust Time	Get the time information from the SNTP server	Not checked
	Auto Adjust Time	0:0:0
	Server specification type	IP Address
	IP Address	0.0.0.0
	Host name	None
	Port No.	0 (Number 123 is used.)
	Retry timer	0 (10 s)
	Adjust Time	+0:0
HTTP	Use Web Function	Checked (Web function is used.)
	Password	None ("ETHERNET" is used.)
	Port No.	0 (80 is used.)

2-1-2 Using the Web Function

The Web function can be used to make the Unit settings for the Ethernet functional element from the Web browser. For details, refer to 2-3 *Web Function*.

2-2 Ethernet Functional Element Memory Allocations

2-2-1 CIO Area Allocations

The various kinds of data are stored in the offset positions shown in the following diagram, from the beginning word in the area for each Unit or functional element.

The beginning word n is calculated by the following equation:

$$\text{Beginning word } n = \text{CIO } 1500 + (25 \times \text{unit number})$$

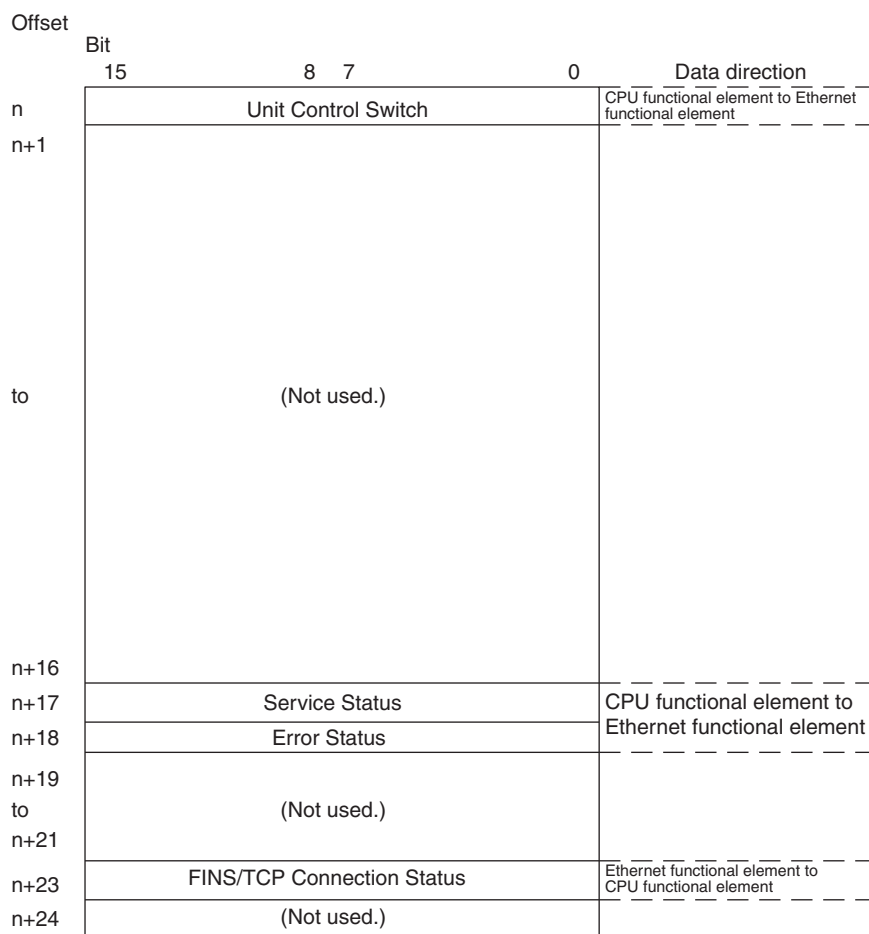

The following items in the diagram can also be checked using software switch settings on the CX-Programmer.

- Service status (FTP status)
- FINS/TCP Connection Status

For explanations of how to use the related communications services listed in the above diagram, refer to the indicated sections.

Unit Control Bits (CPU Functional Element to Ethernet Functional Element)

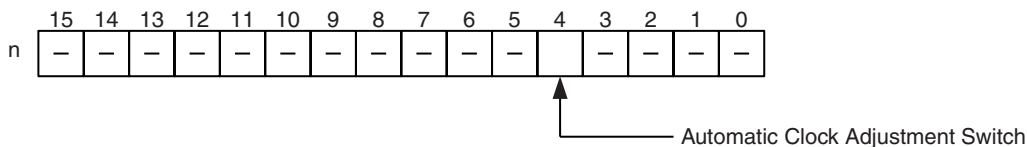

Bit	Switch	Status	Manipulated by	Unit operation	Reference
0 to 3	(Not used.)	---	---	---	---
4	Automatic Clock Adjustment Switch	ON	User	The automatic clock adjustment is executed when this bit turns ON.	<i>Operation Manual, Construction of Applications, SECTION 5 (W420)</i>
		OFF	Unit	Turned OFF by Unit after automatic clock adjustment has been completed.	
5 to 15	(Not used.)	---	---	---	---

Automatic Clock Adjustment Switch (Bit 4)

The automatic clock adjustment can be executed by turning this switch ON. The SNTP server required for the automatic clock adjustment is set in the Unit Setup.

After the automatic clock adjustment has been completed, the Ethernet functional element will automatically turn this switch OFF. Until then, do not forcibly manipulate the switch.

Service Status (Ethernet Functional Element to CPU Functional Element)

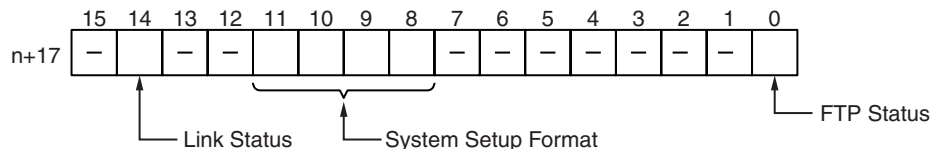

Bit	Name	Status	Manipulated by	Unit operation	Reference
0	FTP Status Flag	ON	Unit	FTP server operating. (FTP client connected.)	<i>Operation Manual, Construction of Applications, SECTION 4 (W420)</i>
		OFF	Unit	FTP server on standby. (FTP client not connect.)	
1 to 7	(Not used.)	---	---	---	---
8 to 11	System Setup Format	ON	Unit	Shows the current format in the CPU Bus Unit System Setup Area by the ON/OFF status of a combination of bits.	<i>SECTION 2 Installation and Initial Setup (W420)</i>
		OFF	Unit		
12 to 13	(Not used.)	---	---	---	---
14	Link Status	ON	Unit	ON while a link is established between hubs.	---
		OFF	Unit	OFF when the link between hubs is terminated.	
15	(Not used.)	---	---	---	---

FTP Status (Bit 0)

Turns ON while connected to an FTP client, and OFF while not connected. With the FTP server function only one FTP client can be connected at a time, so while this bit is ON no other clients can connect to the server.

The FTP status is also shown by the Ethernet functional element's FTP indicator, as follows:

- Not lit: FTP server on standby. (FTP status: OFF)
- Lit: FTP server operating. (FTP status: ON)

System Setup Format (Bits 8 to 11)

These bits show the format classification in the CPU Bus Unit System Setup Area.

Bit address				Format classification
11	10	9	8	
0	0	0	0	ETN11 mode
0	0	0	1	ETN21 mode
Other				Reserve

Note ETN11 mode indicates that the CJ1W-ETN11 System Setup format is being used without modification after replacing a CJ1W-ETN11 (10Base-T Ethernet Unit) with a CJ1W-ETN21 (100Base-T Ethernet Unit). The CX-Programmer can be used to switch the format between ETN21 mode and ETN11 mode.

ETN11 mode is not required, however, so normally use ETN21 mode (default setting).

Error Status (Ethernet Functional Element to CPU Functional Element)

The status of errors that occur at the Ethernet functional element is reflected as shown in the following diagram.

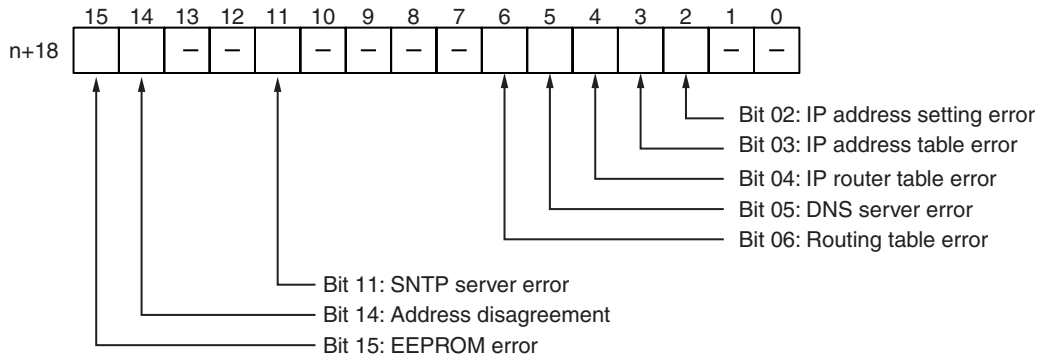

Bit	Error	Status	Manipulated by	Unit operation
0 to 1	(Not used.)	---	---	---
2	IP address setting error	ON	Unit	ON if any of the following conditions apply to the IP address. • All bits in the host ID are 0 or 1. • All bits in the network ID are 0 or 1. • All bits in the subnet ID are 1. • The IP address begins with 127 (0x7F)
		OFF	Unit	OFF when the IP address is normal.
3	IP address table error	ON	Unit	ON if the IP address table information is incorrect.
		OFF	Unit	OFF when the IP address table is normal.
4	IP router table error	ON	Unit	ON if the IP router table information is incorrect.
		OFF	Unit	OFF when the IP address table is normal.
5	DNS server error	ON	Unit	ON when the following errors occur during DNS server operation: • An illegal server IP address is set. • A timeout occurs during communications with the server.
		OFF	Unit	OFF when DNS server operation is normal.
6	Routing table error	ON	Unit	ON if the routing table information is incorrect.
		OFF	Unit	OFF when the routing table is normal.
7 to 10	(Not used.)	---	---	---
11	SNTP server error	ON	Unit	ON when the following errors occur during SNTP server operation: • An illegal server IP address or host name is set. • A timeout occurs during communications with the server.
		OFF	Unit	OFF when SNTP server operation is normal.
12 to 13	(Not used.)	---	---	---
14	Address disagreement	ON	Unit	ON if the remote IP address is set to automatic generation but the local IP address host number and FINS node address do not agree.
		OFF	Unit	OFF under all other circumstances.
15	EEPROM error	ON	Unit	ON if an error has occurred in the EEPROM memory.
		OFF	Unit	OFF when the EEPROM memory is normal.

2-2-2 DM Area Allocations

The various kinds of data are stored in the offset positions shown in the following diagram, from the beginning word in the area for each functional element.

The beginning word m is calculated by the following equation:

$$\text{Beginning word } m = D30000 + (100 \times \text{unit number})$$

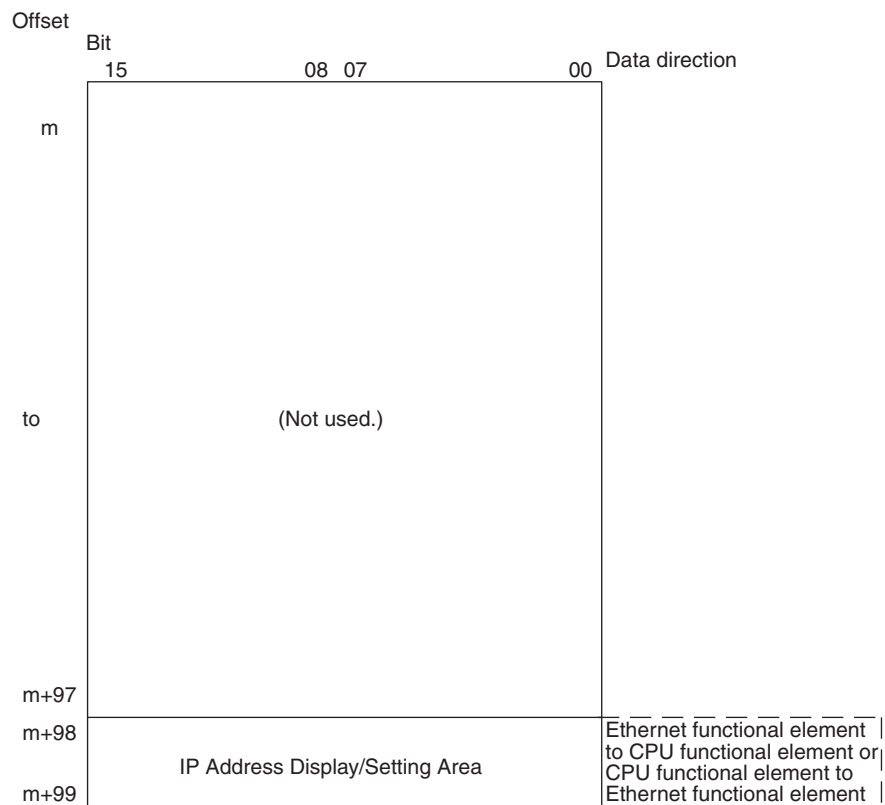

IP Address Display/Setting Area

	15	14	13	12	11	10	9	8	7	6	5	4	3	2	1	0
m+98	(1)					(2)					(3)				(4)	
m+99	(5)					(6)					(7)				(8)	

IP address: (1)(2).(3)(4).(5)(6).(7)(8) (Hex)

If the local IP address in the CPU Bus Unit System Setup is set to a value other than 0.0.0.0, this area (words m+98 and m+99) will act as an IP Address Display Area and the local IP address set in the CPU Bus Unit System Setup will be read and stored here when the power is turned ON or the Ethernet functional element restarted. If the local IP address in the CPU Bus Unit System Setup is set to 0.0.0.0 (the default setting), this value is read by the Ethernet functional element when the power is turned ON or the Ethernet functional element is restarted and is used as the local IP address.

Note Choose the method used to set the local IP address as follows:

Set the local IP address in the CPU Bus Unit System Setup when making other settings in the CPU Bus Unit System Setup. The settings are made with CX-Programmer.

Set the local IP address in the allocated words in the DM Area when using the CPU Bus Unit System Setup at its default settings (i.e., for simple operation). The setting is usually made with a Programming Console.

Application	Setting device	Setting area	Remarks
Simple operation (i.e., The CPU Unit Bus System Setup is used at its default settings. Only the IP address is set.)	Programming Console (CX-Programmer can also be used.)	Allocated words in the DM Area	The setting in the allocated words in the DM Area is enabled only when the IP address in the CPU Unit Bus System Setup is set to 0.0.0.0. If the IP address in the CPU Unit Bus System Setup is set to a value other than 00.00.00.00, this value is stored in the allocated words in the DM Area.
Operation with the CPU Unit Bus System Setup set as desired (i.e., The default settings are not used.)	CX-Programmer	CPU Unit Bus System Setup	The IP address set in the CPU Unit Bus System Setup is stored in the allocated words in the DM Area.

- Note**
1. If a value other than 00.00.00.00 is set as the local IP address in the CPU Bus Unit System Setup, even if an IP address is set in the allocated words in the DM Area, it will be overwritten with the setting in the CPU Bus Unit System Setup.
 2. It is not possible to set the following IP addresses. If any of these values are set, the ERH indicator will flash.
 - IP addresses where all network number bits are 0 or 1.
 - IP addresses where all host number bits are 0 or 1.
 - IP addresses where all subnet number bits are 1.
 - IP addresses that start with 127 (7F hexadecimal, e.g., 127.35.21.16).

2-3 Web Function

Ethernet functional element can use a Web browser from a personal computer or other device to easily make the Ethernet functional element's system settings and monitor statuses.

Web Function List

The information displayed on the window from the Web browser for the Ethernet functional element is as follows:

Unit Setup Functions

Menu item	Parameter item	Corresponding CX-Programmer function
Settings		CX-Programmer's Ethernet Unit Setup window
IP address and Protocols		---

Menu item	Parameter item	Corresponding CX-Programmer function
System		---
	IP address	Unit Setup window- Setup Tab - <i>IP Address</i>
	Net mask	Unit Setup window- Setup Tab - <i>Sub-net Mask</i>
	Enable CIDR	Unit Setup window- Setup Tab - <i>Sub-net Mask - Enable CIDR</i>
	FINS/UDP Port	Unit Setup window- Setup Tab - <i>FINS/UDP Port</i>
	FINS/TCP Port	Unit Setup window- Setup Tab - <i>FINS/TCP Port</i>
	Address conversion mode	Unit Setup window- Setup Tab - <i>Conversion</i>
	Auto (Dynamic)	Unit Setup window- Setup Tab - <i>Auto (dynamic)</i>
	Auto (Static)	Unit Setup window- Setup Tab - <i>Auto (Static)</i>
	Manual	Unit Setup window- Setup Tab - <i>Table used</i>
	Auto & Manual	Unit Setup window- Setup Tab - <i>Mixed</i>
	Destination IP address (Change Dynamically)	Unit Setup window- Setup Tab - <i>Destination IP Address (Change Dynamically)</i>
	Broadcast option	Unit Setup window- Setup Tab - <i>Broadcast</i>
	Baud rate	Unit Setup window- Setup Tab - <i>Baud Rate</i>
	TCP/IP keep-alive	Unit Setup window- Setup Tab - <i>TCP/IP keep-alive</i>
	FINS/TCP Protected	Unit Setup window- FINS/TCP Tab - <i>Use IP address to protect</i>
	SMTP Server (Host name or IP address)	Unit Setup window- SMTP Tab - <i>Server specification type</i>
	POP Server (Host name or IP address)	Unit Setup window- POP Tab - <i>Server specification type</i>
SNTP Server (Host name or IP address)	Unit Setup window- Auto Adjust Time Tab - <i>Server specification type</i>	
FTP		Unit Setup window- Setup Tab
	Login name	Unit Setup window- Setup Tab - <i>FTP (Login)</i>
	Password	Unit Setup window- Setup Tab - <i>FTP (Password)</i>
	Port No.	Unit Setup window- Setup Tab - <i>FTP (Port No.)</i>
DNS		Unit Setup window- DNS Tab
	IP address of DNS server	Unit Setup window- DNS Tab - <i>IP Address</i>
	Port No.	Unit Setup window- DNS Tab - <i>Port No.</i>
	Retry timer	Unit Setup window- DNS Tab - <i>Retry timer</i>
SNTP		Unit Setup window- Auto Adjust Time Tab
	IP Address (or Host name)	Unit Setup window- Auto Adjust Time Tab - <i>IP Address or Host name</i>
	Port No.	Unit Setup window- Auto Adjust Time Tab - <i>Port No.</i>
	Auto Adjust Time	Unit Setup window- Auto Adjust Time Tab - <i>Auto Adjust Time</i>
	Adjust Time	Unit Setup window- Auto Adjust Time Tab - <i>Adjust Time</i>
	Retry timer	Unit Setup window- Auto Adjust Time Tab - <i>Retry timer</i>
	Option (Get the time info. from the SNTP server)	Unit Setup window- Auto Adjust Time Tab - <i>Get the time information from the SNTP server</i>
HTTP		Unit Setup window- HTTP Tab
	WEB Password	Unit Setup window- HTTP Tab - <i>Password</i>
	WEB Password (Confirm)	None (for confirmation of Web password)
	Port No.	Unit Setup window- HTTP Tab - <i>Port No.</i>
	Option (Use Web Function)	Unit Setup window- HTTP Tab - <i>Use Web Function</i>
IP address/router table		Unit Setup window- Setup Tab
IP address table		Unit Setup window- Setup Tab - <i>IP Address Table</i>
IP router table		Unit Setup window- Setup Tab - <i>IP Router Table</i>
FINS/TCP		Unit Setup window- FINS/TCP Tab

Menu item	Parameter item	Corresponding CX-Programmer function
Connection (1-8)		Unit Setup window- FINS/TCP Tab - No. (1 to 8)
	FINS/TCP server / client	Unit Setup window- FINS/TCP Tab - <i>FINS/TCP Mode</i>
	IP Address	Unit Setup window- FINS/TCP Tab - <i>IP Address</i>
	Auto-allocated FINS node	Unit Setup window- FINS/TCP Tab - <i>Auto allocated FINS node</i>
	keep-alive	Unit Setup window- FINS/TCP Tab - <i>keep-alive</i>
Connection 9-16		Unit Setup window- FINS/TCP Tab - No. (9 to 16)

Status Monitor

Menu item	Corresponding CX-Programmer function
Status View	---
Unit information	FINS(0501): CONTROLLER DATA READ
Unit status	FINS(0601): CONTROLLER STATUS READ
Protocol status	---
IP status	FINS(2762): PROTOCOL STATUS READ, IP status
ICMP status	FINS(2762): PROTOCOL STATUS READ, ICMP status
TCP status	FINS(2762): PROTOCOL STATUS READ, TCP status
UDP status	FINS(2762): PROTOCOL STATUS READ, UDP status
Memory status	FINS(2763): MEMORY STATUS READ
Socket status	FINS(2764): SOCKET STATUS READ
Fins status	Ethernet Unit's (functional element's) internal node table
Error log	FINS(2102): ERROR LOG READ

Web Function Password

To prevent unauthorized access to the Ethernet functional element from a Web browser, password entry is required to enable display and setting of the parameters. Even if the password has not been set, the default password "ETHERNET" must be entered. To change this password, set a new password in the HTTP Tab of the CX-Programmer's Unit Setup, or use the Web function and select **Settings - IP address and Protocols - HTTP**.

- Note**
1. Setting a new Web function password as soon as possible is recommended to prevent unauthorized access.
 2. The Web function can also be disabled by setting in the Web function option.

Using the Web Function (Setting Password)

The Ethernet functional element's Web window is displayed by accessing the following URL from the Web browser.

URL: [http://\(Ethernet functional element's IP address\)/0](http://(Ethernet functional element's IP address)/0)

Use the following procedure to set the Ethernet functional element's system settings (HTTP password setting in this example) using Internet Explorer version 6.0 and the Ethernet functional element's Web function.

- 1,2,3...**
1. Connect to the Ethernet functional element from the Web browser. In this example, the URL is specified as <http://192.168.250.1/0> using the

Ethernet functional element's default IP address.

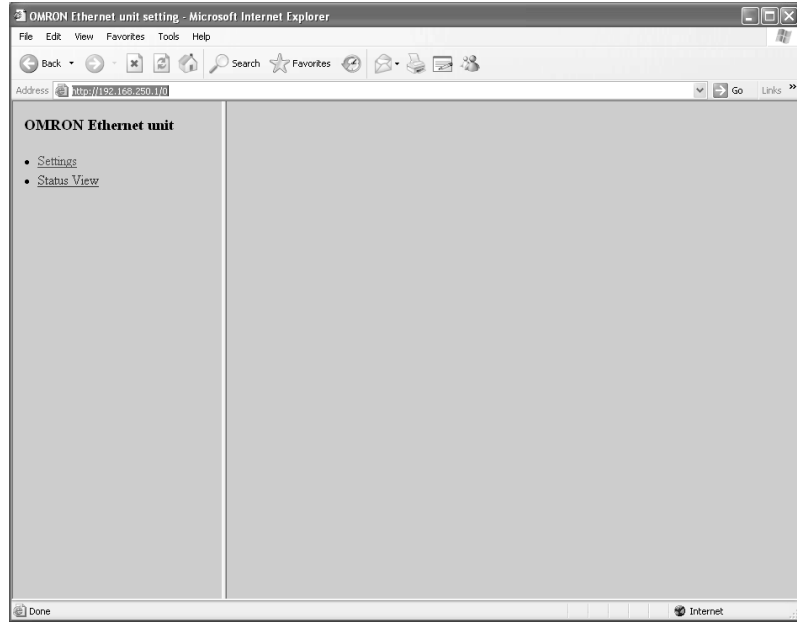

2. Select **Settings** from the menu on the left side of the window to display the **Settings Menu**.

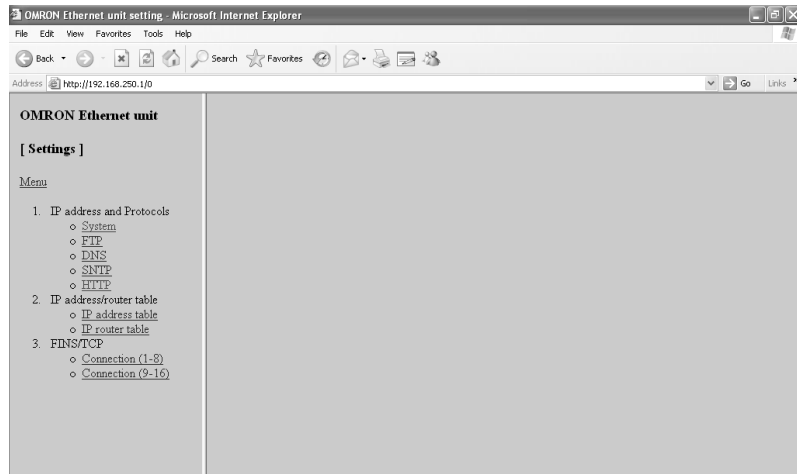

3. Select **1. IP address and Protocols - System** to display the **Login Password** field on the right of the window.

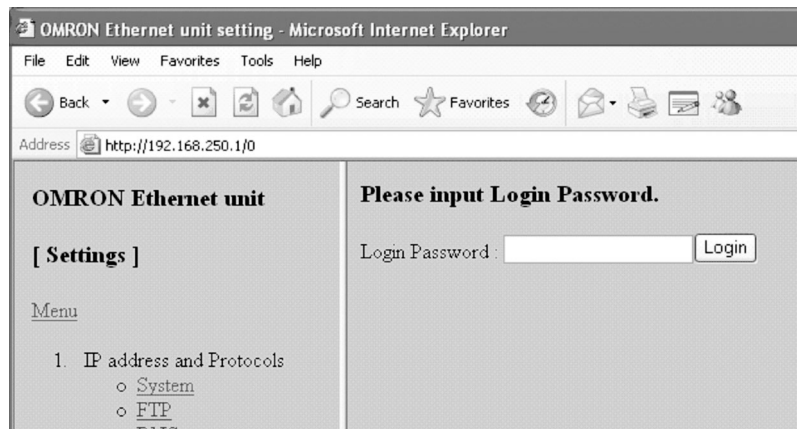

- Input the default password (“ETHERNET” all in upper case) and click the **Login Button**.

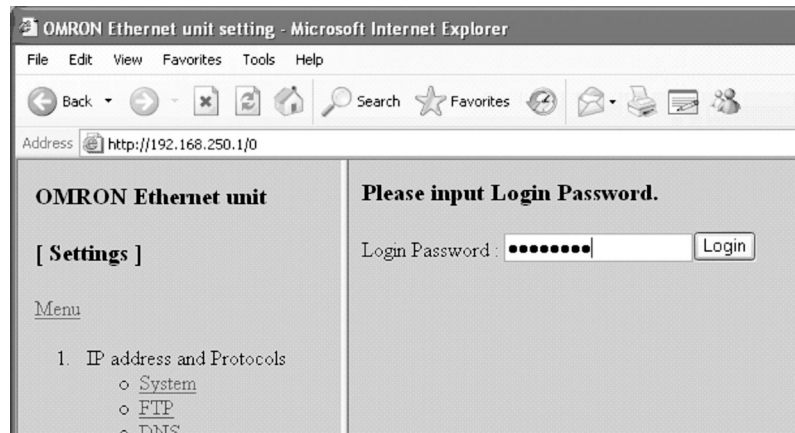

When login is successful, the following setting window will be displayed.

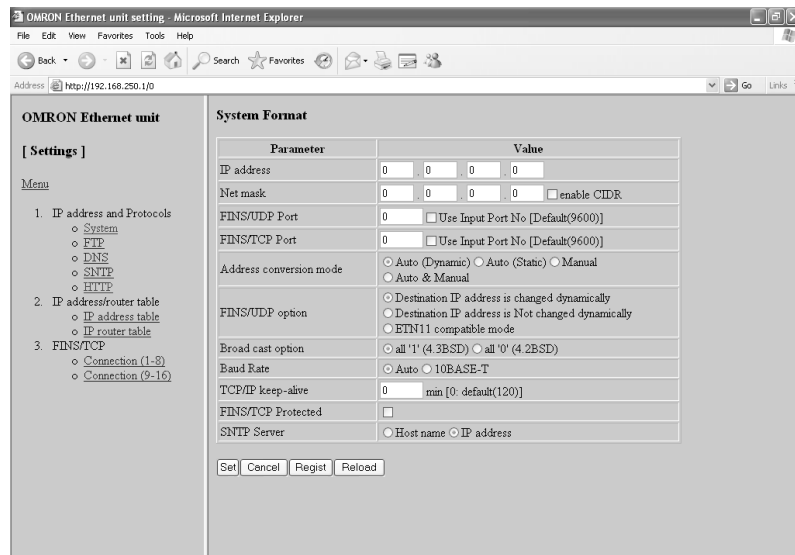

- Select HTTP from the menu to display the HTTP setting items. The following window shows the default settings.

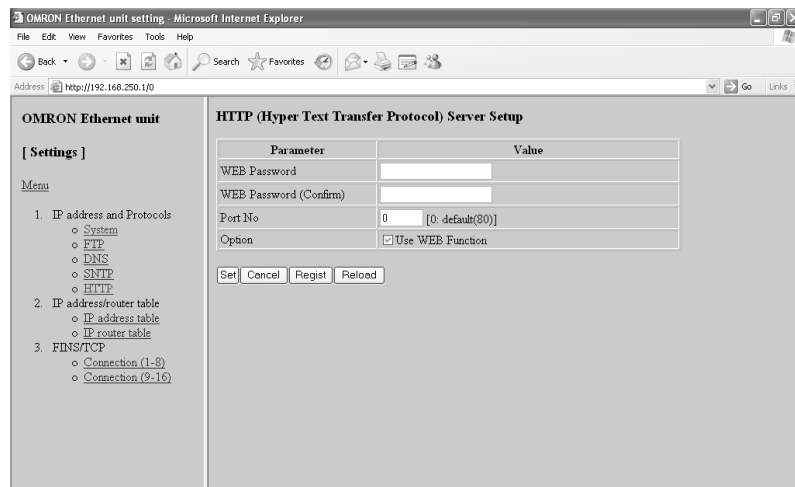

- Make the required settings (i.e., the password in this example). To prevent incorrect password entry, set the same password in the **WEB**

Password field and WEB Password (Confirm) field.

Parameter	Value
WEB Password
WEB Password (Confirm)
Port No	0 [0: default(80)]
Option	<input checked="" type="checkbox"/> Use WEB Function

Set Cancel Regist Reload

- After entering the correct password, click the **Set** Button followed by the **Regist** Button.

Set Cancel Regist Reload

The Set Button is used to transfer the entered values from the personal computer, and temporarily register them in the Ethernet functional element.

The Regist Button stores the set values that have been temporarily registered in the Ethernet to the flash memory (non-volatile memory) of the CPU functional element. The Ethernet functional element reads the unit settings from flash memory (non-volatile memory) when the power is turned ON or the functional element is restarted. Therefore, when making the unit settings using the Web function, always click the Set Button before the Regist Button. Otherwise the entered set values will not be used. The Set Button and Regist Button are provided on the window for each setting item.

Note To prevent unauthorized Web access, the Web function can be disabled. Select **HTTP - Option** and deselect the **Use Web Function** option. Click the **Set** Button followed by the **Regist** Button. This setting is enabled by turning ON the power to the Ethernet functional element again or restarting the Ethernet functional element. This setting can be cancelled only through the CX-Programmer Unit Setup (version 5.0 or later).

Option Use WEB Function

Set Cancel Regist Reload

- The functions of the other button are as follows:
 - Cancel Button**
Use this button to cancel the entered value and display the value that was previously set with the Set Button again. If the Set Button has not been clicked, the value that was read from the CPU functional element's flash memory (non-volatile memory) when the Ethernet functional element was started will be displayed.
 - Reload Button**
Use this button read and display the values saved in the CPU functional element's flash memory (non-volatile memory).
- To enable the unit settings that have been registered in the CPU functional element's flash memory (non-volatile memory, turn the power to the PLC system OFF and ON again, or restart the Ethernet functional element.

SECTION 3

Inspection and Maintenance

This section provides inspection and maintenance information.

3-1	Inspections	30
3-1-1	Inspection Points.....	30
3-1-2	Unit Replacement Precautions	31
3-2	Replacing User-serviceable Parts	32

3-1 Inspections

Daily or periodic inspections are required in order to maintain the PLC's functions in peak operating condition.

3-1-1 Inspection Points

Although the major components in CJ-series PLCs have an extremely long life time, they can deteriorate under improper environmental conditions. Periodic inspections are thus required to ensure that the required conditions are being kept.

Inspection is recommended at least once every six months to a year, but more frequent inspections will be necessary in adverse environments.

Take immediate steps to correct the situation if any of the conditions in the following table are not met.

No.	Item	Inspection	Criteria	Action
1	Source Power Supply	Check for voltage fluctuations at the power supply terminals.	The voltage must be within the allowable voltage fluctuation range. (See note.)	Use a voltage tester to check the power supply at the terminals. Take necessary steps to bring voltage fluctuations within limits.
2	I/O Power Supply	Check for voltage fluctuations at the I/O terminals.	Voltages must be within specifications for each Unit.	Use a voltage tester to check the power supply at the terminals. Take necessary steps to bring voltage fluctuations within limits.
3	Ambient environment	Check the ambient temperature. (Inside the control panel if the PLC is in a control panel.)	0 to 55°C	Use a thermometer to check the temperature and ensure that the ambient temperature remains within the allowed range of 0 to 55°C.
		Check the ambient humidity. (Inside the control panel if the PLC is in a control panel.)	Relative humidity must be 10% to 90% with no condensation.	Use a hygrometer to check the humidity and ensure that the ambient humidity remains within the allowed range.
		Check that the PLC is not in direct sunlight.	Not in direct sunlight	Protect the PLC if necessary.
		Check for accumulation of dirt, dust, salt, metal filings, etc.	No accumulation	Clean and protect the PLC if necessary.
		Check for water, oil, or chemical sprays hitting the PLC.	No spray on the PLC	Clean and protect the PLC if necessary.
		Check for corrosive or flammable gases in the area of the PLC.	No corrosive or flammable gases	Check by smell or use a sensor.
		Check the level of vibration or shock.	Vibration and shock must be within specifications.	Install cushioning or shock absorbing equipment if necessary.
		Check for noise sources near the PLC.	No significant noise sources	Either separate the PLC and noise source or protect the PLC.

No.	Item	Inspection	Criteria	Action
4	Installation and wiring	Check that each Unit is connected and locked to the next Unit securely.	No looseness	Press the connectors together completely and lock them with the sliders.
		Check that cable connectors are fully inserted and locked.	No looseness	Correct any improperly installed connectors.
		Check for loose screws in external wiring.	No looseness	Tighten loose screws with a Phillips-head screwdriver.
		Check crimp connectors in external wiring.	Adequate spacing between connectors	Check visually and adjust if necessary.
		Check for damaged external wiring cables.	No damage	Check visually and replace cables if necessary.
5	User-serviceable parts	Check whether the battery has reached its service life. CJ1 and CJ1-H CPU Units: CJ1W-BAT01 CJ1M CPU Units: CJ1W-BAT01 Battery	Service life expectancy is 5 years at 25°C, less at higher temperatures. (From 0.75 to 5 years depending on model, power supply rate, and ambient temperature.)	Replace the battery when its service life has passed even if a battery error has not occurred. (Battery life depends upon the model, the percentage of time in service, and ambient conditions.)

Note The following table shows the allowable voltage fluctuation ranges for source power supplies.

Supply voltage	Allowable voltage range
100 to 240 V AC	85 to 264 V AC
24 V DC	19.2 to 28.8 V DC

Tools Required for Inspections

Required Tools

- Slotted and Phillips-head screwdrivers
- Voltage tester or digital voltmeter
- Industrial alcohol and clean cotton cloth

Tools Required Occasionally

- Synchroscope
- Oscilloscope with pen plotter
- Thermometer and hygrometer (humidity meter)

3-1-2 Unit Replacement Precautions

Check the following after replacing any faulty Unit.

- Do not replace a Unit until the power is turned OFF.
- Check the new Unit to make sure that there are no errors.
- If a faulty Unit is being returned for repair, describe the problem in as much detail as possible, enclose this description with the Unit, and return the Unit to your OMRON representative.
- For poor contact, take a clean cotton cloth, soak the cloth in industrial alcohol, and carefully wipe the contacts clean. Be sure to remove any lint prior to remounting the Unit.

Note 1. The CPU functional element and Ethernet functional element are inseparable parts of the CJ1M CPU Unit with Ethernet Functions and cannot be detached. Therefore, if either functional element is faulty, replace the entire Unit.

2. When replacing a CPU Unit, be sure that not only the user program but also all other data required for operation is transferred to or set in the new CPU functional element before starting operation, including DM Area and HR Area settings. If data area and other data are not correct for the user program, unexpected accidents may occur. Be sure to include the routing tables, Controller Link Unit data link tables, network parameters, and other CPU Bus Unit data, which are stored as parameters in the CPU functional element. Refer to the CPU Bus Unit and Special I/O Unit operation manuals for details on the data required by each Unit.
3. The simple backup operation can be used to store the user program and all parameters for the CJ1M CPU functional element, DeviceNet Units, Serial Communications Units, and other specific Units in a Memory Card as backup files. A Memory Card and the simple backup operation can be used to easily restore data after replacing any of these Units. Refer to the *CS/CJ Series Programming Manual (W394)* for details.

3-2 Replacing User-serviceable Parts

The following parts should be replaced periodically as preventative maintenance. The procedures for replacing these parts are described later in this section.

- Battery (backup for the CPU functional element’s internal clock and RAM)

Battery Functions

The battery maintains the internal clock and the following data of the CPU functional element’s RAM while the main power supply is OFF.

- The user program
- The PLC Setup
- Retained regions of I/O memory (such as the Holding Area and DM Area)

If the battery is not installed or battery voltage drops too low, the internal clock will stop and the data in RAM will be lost when the main power supply goes OFF.

Battery Service Life and Replacement Period

At 25°C, the maximum service life for batteries is five years whether or not power is supplied to the CPU Unit while the battery is installed. The battery’s lifetime will be shorter when it is used at higher temperatures and when power is not supplied to the CPU Unit for long periods.

The following table shows the approximate minimum lifetimes and typical lifetimes for the backup battery (total time with power not supplied).

Model	Approx. maximum lifetime	Approx. minimum lifetime (See note.)	Typical lifetime (See note.)
CJ1M-CPU1□-ETN	5 years	13,000 hours (1.5 years)	43,000 hours (5 years)

Note The minimum lifetime is the memory backup time at an ambient temperature of 55°C. The typical lifetime is the memory backup time at an ambient temperature of 25°C.

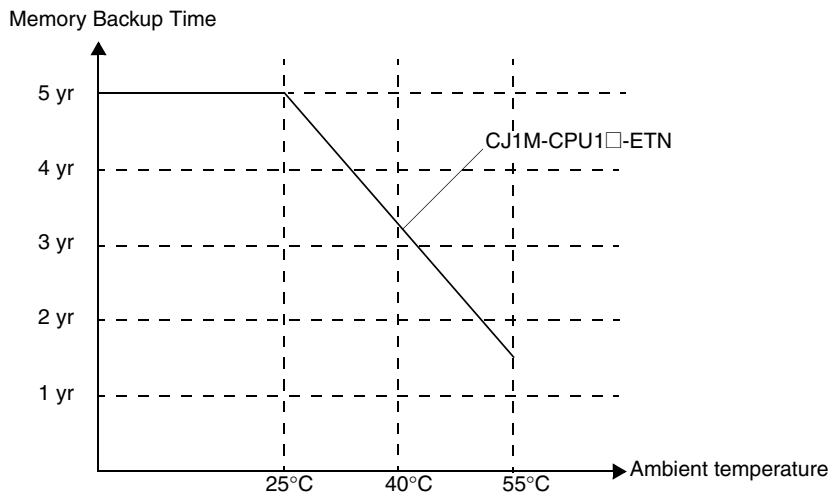

This graphic is for reference only.

Low Battery Indicators

If the PLC Setup has been set to detect a low-battery error, the ERR/ALM indicator on the front of the CPU functional element will flash when the battery is nearly discharged.

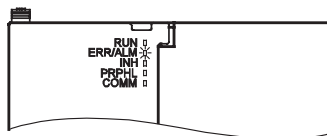

When the ERR/ALM indicator flashes, connect a Programming Console to the peripheral port and read the error message. If the message “BATT LOW” appears on the Programming Console* and the Battery Error Flag (A40204) is ON (see note 1), first check whether the battery is properly connected to the CPU Unit. If the battery is properly connected, replace the battery as soon as possible.

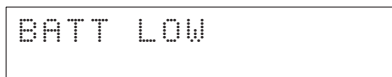

Once a low-battery error has been detected, it will take 5 days at an ambient temperature of 25°C (see note 2) before the battery fails assuming that power has been supplied at least once a day. Battery failure and the resulting loss of data in RAM can be delayed by ensuring that the CPU Unit power is not turned OFF until the battery has been replaced.

- Note**
1. The PLC Setup must be set to detect a low-battery error (Detect Low Battery). If this setting has not been made, the BATT LOW error message will not appear on the Programming Console and the Battery Error Flag (A40204) will not go ON when the battery fails.
 2. The battery will discharge faster at higher temperatures, e.g., 4 days at 40°C and 2 days at 55°C.

Replacement Battery

Use the CJ1W-BAT01 (for CJ1M) Battery Set. Be sure to install a replacement battery within two years of the production date shown on the battery's label.

CJ1M CPU Units with Ethernet Functions

Production Date



Manufactured in August 2004.

Replacement Procedure

Use the following procedure to replace the battery when the previous battery has become completely discharged. You must complete this procedure within five minutes after turning OFF the power to the CPU Unit to ensure memory backup.

- Note**
1. The battery can be replaced without turning OFF the power supply. To do so, always touch a grounded piece of metal to discharge static electricity from your body before starting the procedure.
 2. After replacing the battery, connect a Programming Device and clear the battery error.

Procedure

- 1,2,3... 1. Turn OFF the power to the CPU Unit.
or If the CPU Unit has not been ON, turn it ON for at least five minutes and then turn it OFF.
Note If power is not turned ON for at least five minutes before replacing the battery, the capacitor that backs up memory when the battery is removed will not be fully charged and memory may be lost before the new battery is inserted.
2. Open the compartment on the upper left of the CPU Unit and carefully draw out the battery.
3. Remove the battery connector.
4. Connect the new battery, place it into the compartment, and close the cover.

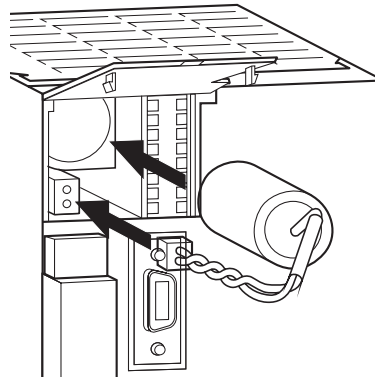

The battery error will automatically be cleared when a new battery is inserted.

Note Connect the new battery within five minutes of disconnecting the old battery. If a battery is not connected for longer than five minutes, data may be lost.

⚠ WARNING Never short-circuit the battery terminals; never charge the battery; never disassemble the battery; and never heat or incinerate the battery. Doing any of these may cause the battery to leak, burn, or rupturing resulting in injury, fire, and possible loss of life or property. Also, never use a battery that has been dropped on the floor or otherwise subject to shock. It may leak.

UL standards require that batteries be replaced by experienced technicians. Always place an experienced technician in charge of battery replacement.

Index

Numerics

100M indicator, 12

A

applications

precautions, xxvii

Auto Adjust Time Tab, 17

Auto allocated FINS node field, 16

B

battery

service life, 32

voltage indicator, 33

bits

error status, 20

BKUP indicator, 10

Broadcast field, 16

C

CIO Area

allocations, 17

CJ Series

definition, xv

Conversion field, 16

CPU Unit

DIP switch, 11

CS Series

definition, xv

D

DIP switch, 11

DM Area

allocations, 21

DNS Tab, 16

E

EC Directives, xxx

ERC indicator, 12

ERH indicator, 12

errors

status, 20

F

FINS/TCP Mode field, 16

FINS/TCP Port field, 16

FINS/TCP Tab, 16

FINS/UDP Port field, 16

flags

FTP Status Flag, 19

FTP indicator, 12

FTP Status Flag, 19

H

HOST indicator, 12

Host name field, 17

HTTP Tab, 17

I

I/O allocations

CIO Area, 17

DM Area, 21

indicators, 10, 12

CPU Unit, 10

inspection

procedures, 30

installation

precautions, xxvii

IP Address field, 16–17

IP Address Table field, 16

IP Router Table field, 16

J-L

keep-alive field, 16

LNK indicator, 12

Login field, 16

M

Mail Address Tab, 16

maintenance

procedures, 32

N

node addresses

setting, 13

O

operating environment

precautions, xxvi

P

parts

replacing parts, 32

Password field, 16

POP Tab, 16

Port No. field, 16–17

precautions, xxiii

applications, xxvii

general, xxiv

handling precautions, 31

operating environment, xxvi
periodic inspections, 30
safety, xxiv

R

RD indicator, 12
Receive Mail Tab, 16
Retry timer field, 16
RUN indicator, 12

S

safety precautions, xxiv
SD indicator, 12
Send Mail Tab, 16
Server specification type field, 17
service status, 19
Setup Tab, 16
SMTP Tab, 16
specifications
 performance, 3
Sub-net Mask field, 16
switch settings
 CPU Unit, 11

T

TCP indicator, 12

U

unit numbers
 setting, 13

Revision History

A manual revision code appears as a suffix to the catalog number on the front cover of the manual.

Cat. No. W441-E1-03

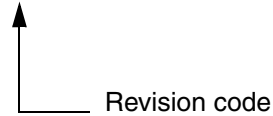

The following table outlines the changes made to the manual during each revision. Page numbers refer to the previous version.

Revision code	Date	Revised content
01	July 2004	Original production
02	February 2005	Minor changes were made as follows: Pages x and xvii: Added information to table for CX-Programmer Ver. 6.0 Page 3: Added information to table Pages 22, 23, 24, and 25: Changed screen diagrams
03	September 2009	Revisions accompanying an upgrade to version 1.5 of the Ethernet functional element. Changed the location of the rotary switches and added CIDR function.

Revision History

OMRON Corporation
Industrial Automation Company

Control Devices Division H.Q.
Automation & Drive Division
Automation Department 1

Shiokoji Horikawa, Shimogyo-ku,
Kyoto, 600-8530 Japan
Tel: (81) 75-344-7084/Fax: (81) 75-344-7149

Regional Headquarters

OMRON EUROPE B.V.
Wegalaan 67-69-2132 JD Hoofddorp
The Netherlands
Tel: (31)2356-81-300/Fax: (31)2356-81-388

OMRON Industrial Automation Global: www.ia.omron.com

OMRON ELECTRONICS LLC

One Commerce Drive Schaumburg,
IL 60173-5302 U.S.A.
Tel: (1) 847-843-7900/Fax: (1) 847-843-7787

OMRON ASIA PACIFIC PTE. LTD.

No. 438A Alexandra Road # 05-05/08 (Lobby 2),
Alexandra Technopark, Singapore 119967
Tel: (65) 6835-3011/Fax: (65) 6835-2711

OMRON (CHINA) CO., LTD.

Room 2211, Bank of China Tower,
200 Yin Cheng Zhong Road,
PuDong New Area, Shanghai, 200120, China
Tel: (86) 21-5037-2222/Fax: (86) 21-5037-2200

Authorized Distributor:

© OMRON Corporation 2004 All Rights Reserved.
In the interest of product improvement,
specifications are subject to change without notice.

Cat. No. W441-E1-03

Printed in Japan
0909