

Cat. No. Z042-E1-4

E5ZD

Multipoint Temperature Controller

OPERATION MANUAL

OMRON

E5ZD
Multipoint Temperature Controller
Operation Manual

Revised November 1996

Notice:

OMRON products are manufactured for use according to proper procedures by a qualified operator and only for the purposes described in this manual.

The following conventions are used to indicate and classify precautions in this manual. Always heed the information provided with them. Failure to heed precautions can result in injury to people or damage to the product.

DANGER Indicates information that, if not heeded, is likely to result in loss of life or serious injury.

WARNING Indicates information that, if not heeded, could possibly result in loss of life or serious injury.

Caution Indicates information that, if not heeded, could result in relative serious or minor injury, damage to the product, or faulty operation.

OMRON Product References

All OMRON products are capitalized in this manual. The word "Unit" is also capitalized when it refers to an OMRON product, regardless of whether or not it appears in the proper name of the product.

The abbreviation "Ch," which appears in some displays and on some OMRON products, often means "word" and is abbreviated "Wd" in documentation in this sense.

The abbreviation "PC" means Programmable Controller and is not used as an abbreviation for anything else.

Visual Aids

The following headings appear in the left column of the manual to help you locate different types of information.

Note Indicates information of particular interest for efficient and convenient operation of the product.

1, 2, 3... 1. Indicates lists of one sort or another, such as procedures, checklists, etc.

© OMRON, 1990

All rights reserved. No part of this publication may be reproduced, stored in a retrieval system, or transmitted, in any form, or by any means, mechanical, electronic, photocopying, recording, or otherwise, without the prior written permission of OMRON.

No patent liability is assumed with respect to the use of the information contained herein. Moreover, because OMRON is constantly striving to improve its high-quality products, the information contained in this manual is subject to change without notice. Every precaution has been taken in the preparation of this manual. Nevertheless, OMRON assumes no responsibility for errors or omissions. Neither is any liability assumed for damages resulting from the use of the information contained in this publication.

TABLE OF CONTENTS

SECTION 1	
Introduction	1
1-1 Product Information	2
1-2 Features	2
1-3 Models Available	3
1-4 Precautions	4
SECTION 2	
Preparations for Operation	9
2-1 E5ZD-4□□□-E/-6□□□-E Hardware	10
2-2 E5ZD-8□□□-E Hardware	24
2-3 E5ZD-8H□□M-E Hardware	34
SECTION 3	
Basic Operation	51
3-1 Overview	52
3-2 Communications	52
3-3 Memory Banks	54
3-4 Parameter Backup	56
3-5 HB and HS Alarms	58
3-6 Fuzzy Control	60
3-7 Features	62
3-8 Adjusting Fuzzy Parameters	64
SECTION 4	
Commands and Responses	67
4-1 Overview	68
4-2 Temperature Control Commands (All Controllers)	71
4-3 Fuzzy Constant Commands (Fuzzy-logic Controllers Only)	109
4-4 Global Read and Control Operations	111
4-5 Global Write Operations	114
SECTION 5	
Transmission Times	119
5-1 Writing Times	120
5-2 Reading Times	120
SECTION 6	
Troubleshooting	123
6-1 Troubleshooting Lists	124
6-2 Loop-Back Communications Test	128
Appendices	
A Specifications	129
B Parameter Defaults, Setting Ranges, and Commands	133
C End Codes	135
D Error Codes	137
E ASCII Codes	139
Index	141
Revision History	143

About this Manual:

This manual describes the operation of the E5ZD Multipoint Temperature Controller and includes the sections described below. The Current Transformer (E54-CT1 or E54-CT3) is not provided with the E5ZD Multipoint Temperature Controller. Purchase current transformers as required for heater burnout detection. The Terminal Block, I/O Block Unit, and cable are not provided with the E5ZD-8H□□M-E. For detailed operating commands of the accessories, refer to their operation manuals.

Please read this manual completely and be sure you understand the information provided before attempting to operate the E5ZD Multipoint Temperature Controller.

Section 1 introduces the E5ZD, describing the various models available and the basic type of system application.

Section 2 provides the steps necessary to prepare for operation, including switch settings and wiring specifications, and also describes the components of the E5ZD.

Section 3 describes the basic operations used to control the E5ZD, including the communications formats necessary for communication from a host computer or PC.

Section 4 describes each of the commands used to control E5ZD operation and the responses returned by the E5ZD to indicate execution status.

Section 5 shows how to compute the time required to write data and have that data become effective in operation, and the time required to read data.

Section 6 describes basic troubleshooting via lists of the possible causes and solutions to some common operational problems.

Appendix A provides the technical specifications of the E5ZD and the optional Current Transformers which are used for HB and HS alarms.

Appendix B provides lists of commands by function, showing the header codes, factory-set default values, and setting limits.

Appendix C provides a short list of the end codes returned with E5ZD responses to indicate execution status.

Appendix D provides a table of the error code used in E5ZD communications.

Appendix E provides a table of the ASCII code used in E5ZD communications.



WARNING Failure to read and understand the information provided in this manual may result in personal injury or death, damage to the product, or product failure. Please read each section in its entirety and be sure you understand the information provided in the section and related sections before attempting any of the procedures or operations given.

SECTION 1

Introduction

This section describes the basic features of the E5ZD Multipoint Temperature Controller, including its position in a control system, and provides basic warnings for handling, installing, and operation.

- 1-1 Product Information 2
- 1-2 Features 2
- 1-3 Models Available 3
 - 1-3-1 Sensors and Temperature Ranges 4
 - 1-3-2 Current Transformer 4
- 1-4 Precautions 4
 - 1-4-1 Handling Precautions 4
 - 1-4-2 Installation Precautions 4
 - 1-4-3 Operating Precautions 5

1-1 Product Information

The E5ZD Multipoint Temperature Controller processes temperature data obtained from sensors and forms a part of a control system.

The Current Transformer (E54-CT1 or E54-CT3) is not provided with the E5ZD Multipoint Temperature Controller. Purchase current transformers as required for heater burnout detection.

The Terminal Block, I/O Block Unit, and cable are not provided with the E5ZD-8H□□M-E.

1-2 Features

The basic features of the E5ZD are outlined below. Refer to relevant sections of this manual for details.

Multipoint PID Control The E5ZD provides four-, six- or eight-point control via a single control-panel-mountable board. PID with feed-forward circuitry is used as the control method.

Host-computer Management The E5ZD does not have setting keys or a display, but is operated through commands downloaded from a host computer.

Removable Terminal Blocks E5ZD-4/-6/-8□□□-E Units use sensor input terminal blocks with detachable upper portions that can be mounted to the Temperature Control Unit after the sensors have been connected.

Remote Input Terminal Blocks E5ZD-8H□□M-E Units can be connected by cable to a remote terminal block that handles sensor inputs, CT inputs, and memory bank designation inputs. Similarly, control outputs and alarm outputs can use an I/O Relay Terminal.

High-speed Processing The E5ZD features a maximum 0.5-second sampling time and a 16-bit CPU to reduce processing time.

Serial Communications The E5ZD is available with RS-232C, RS-422, or RS-485 communications. With RS-422 or RS-485 communications, a single host computer can be used to control up to 16 E5ZDs.

Memory Banks For each controlled point, there is a memory bank that consists of the various set values such as control temperatures and PID constants. This enables you to change a group of settings with a single operation. There are eight memory banks, and you can use either communications or switch settings to designate the one to be used.

Heater-burnout Detection The E5ZD can be ordered with a detector for circuit breaks in the heater. If a break is detected, the HB alarm output is turned ON.

Other Errors Detected SSR errors and welded relay contacts can also be detected. These conditions turn ON an HS alarm output.

Memory Protection All settings for temperature control, including PID values, can be transferred to nonvolatile memory to provide protection against power interruptions.

Diagnostic Functions Open circuit faults in the sensor circuit, and input temperatures that are too high or too low can be detected.

Upon the application of power, memory checks are carried out, and AD converter checks are run to ensure correct temperature measurements. A watchdog

timer increases the reliability and safety of the Unit by aiding in the recovery from CPU errors resulting from noise and other causes.

**Fuzzy Control
(E5ZD-8F□□□□-E only)**

Hybrid control (i.e., PID with feed-forward circuitry used with fuzzy control) assures excellent response characteristics for external disturbances.

Other Features

Manual operation, lamp operation, output variable limit, output deviation limit, input shift, digital filter, and balanceless-bumpless features assure highly powerful operation.

1-3 Models Available

The E5ZD is available in either 4-point, 6-point or 8-point models, with or without heater circuit burnout detection, for either thermocouples or platinum resistance thermometers, and in any of the following serial communications classifications: RS-232C, RS-422, or RS-485. Either terminal-block or connector connection is available for certain models and certain models are also available with fuzzy-logic control. These are summarized in the following tables.

Standard Models

Sensor input Connection	No. of points	Heater-burnout detection	Communications	Thermocouple	Resistance thermometers
Terminal block	4	No	RS-232C	E5ZD-4A01KJ-E	E5ZD-4A01P-E
			RS-422	E5ZD-4A02KJ-E	E5ZD-4A02P-E
			RS-485	E5ZD-4A03KJ-E	E5ZD-4A03P-E
		Yes	RS-232C	E5ZD-4H01KJ-E	E5ZD-4H01P-E
			RS-422	E5ZD-4H02KJ-E	E5ZD-4H02P-E
			RS-485	E5ZD-4H03KJ-E	E5ZD-4H03P-E
	6	No	RS-232C	E5ZD-6A01KJ-E	E5ZD-6A01P-E
			RS-422	E5ZD-6A02KJ-E	E5ZD-6A02P-E
			RS-485	E5ZD-6A03KJ-E	E5ZD-6A03P-E
		Yes	RS-232C	E5ZD-6H01KJ-E	E5ZD-6H01P-E
			RS-422	E5ZD-6H02KJ-E	E5ZD-6H02P-E
			RS-485	E5ZD-6H03KJ-E	E5ZD-6H03P-E
8	No	RS-232C	E5ZD-8A01KJ-E	E5ZD-8A01P-E	
		RS-422	E5ZD-8A02KJ-E	E5ZD-8A02P-E	
		RS-485	E5ZD-8A03KJ-E	E5ZD-8A03P-E	
	Yes	RS-232C	E5ZD-8H01KJ-E	E5ZD-8H01P-E	
		RS-422	E5ZD-8H02KJ-E	E5ZD-8H02P-E	
		RS-485	E5ZD-8H03KJ-E	E5ZD-8H03P-E	
Connector	8	Yes	RS-422	E5ZD-8H02KJM-E	E5ZD-8H02PM-E
			RS-485	E5ZD-8H03KJM-E	E5ZD-8H03PM-E

Fuzzy-logic Models

Sensor input Connection	No. of points	Heater-burnout detection	Communications	Thermocouple	Resistance thermometers
Terminal block	8	No	RS-232C	E5ZD-8FA01KJ-E	E5ZD-8FA01P-E
			RS-422	E5ZD-8FA02KJ-E	E5ZD-8FA02P-E
			RS-485	E5ZD-8FA03KJ-E	E5ZD-8FA03P-E
		Yes	RS-232C	E5ZD-8FH01KJ-E	E5ZD-8FH01P-E
			RS-422	E5ZD-8FH02KJ-E	E5ZD-8FH02P-E
			RS-485	E5ZD-8FH03KJ-E	E5ZD-8FH03P-E
Connector	8	Yes	RS-422	E5ZD-8FH02KJM-E	E5ZD-8FH02PM-E
			RS-485	E5ZD-8FH03KJM-E	E5ZD-8FH03PM-E

1-3-1 Sensors and Temperature Ranges

Thermocouple models are compatible with either K (CA) or J (IC) sensors and can be set in a temperature range of either 0° to 400°C or 0° to 600°C at increments of 1°C.

Platinum resistance sensor models are compatible with either JPt100 or Pt100 sensors and can be set in a temperature range of either –100.0° to 200.0°C at increments of 0.1°C, or in a range of 0° to 500°C at increments of 1°C.

All models can also be set in Fahrenheit. The ranges for this would be the Fahrenheit conversions of the above ranges. Setting accuracy would be either 1° F or 0.1° F.

1-3-2 Current Transformer

Either of the following models can be used for the Current Transformer, depending on the desired hole diameter.

Hole diameter	Model number
5.8 mm	E54-CT1
12.0 mm	E54-CT3

1-4 Precautions

The following precautions are provided here for your convenience. Be sure to abide by these precautions whenever working with the E5ZD.

1-4-1 Handling Precautions

- The E5ZD is shipped in a insulating cover that is treated against static electricity.
- Always keep the board inside the cover when storing or transporting it.
- Touch a grounded object with your hand before handling the board to be sure that your body is free from static electricity.
- Always lay the board on an antistatic mat when working on it.
- Never remove the board from the cover or leave it unprotected unless working on it.
- Never touch the printed circuit or the components on the board; hold it by the edge area.
- Never place the board into plastic bags of any sort to avoid static-electricity interference.

1-4-2 Installation Precautions

- Protect I/O wiring against noise. Never run wires parallel to, or in the same duct as, high-voltage or high-current lines. Keep the distance between I/O wires

and high-voltage or high-current lines as large as possible. If necessary, use shielded cables to avoid interference.

- Separate the E5ZD Unit and all I/O wiring to it as far as possible from any devices generating strong high-frequency waves (e.g., high-frequency welders) or those that generate surges.
- If the E5ZD is located close to devices generating noise, attach surge suppressors or noise filters to the noise-generating devices. Be particularly careful of motors, transformers, solenoids, magnetic coils, and other inductive devices. When installing noise filters, verify voltage and current capacities beforehand, and install the filters as close as possible to the E5ZD.
- To reduce noise emitted from the E5ZD and to protect it from external noise, be sure to ground the rack or case and ground the frame ground terminal of the external power source.
- Although the E5ZD can be installed at any angle without inhibiting operation, the installation angle will affect heat dissipation from the terminal board, and may cause variations in temperature measurements. To minimize these effects, the E5ZD should be installed horizontally, installed vertically with the terminal board up and the communications connectors down, or installed with a fan blowing on the terminal board to provide even temperatures to all terminals.

The E5ZD-8H□□M-E should either be installed horizontally or else vertically with the sensor connectors down.

- With thermocouple models, use a compensating lead suitable for the thermocouple.
- Operate and store the E5ZD in an environment free from icing, condensation, dust, dirt, corrosive gases (particularly sulfuric or ammonia gas), excessive vibration, excessive shock, water, grease, and oil. Do not operate or store the E5ZD where subject to extreme temperature changes or dissipating heat (e.g., from a furnace).
- Never place so much weight on the E5ZD that it will deform or otherwise change, whether in storage or operation.
- The operating environment for the E5ZD should have temperatures between -10° and 55°C , between 35% and 85% humidity, and no condensation or icing.
- The storage environment for the E5ZD should have temperatures between -25° and 65°C , 35% and 85% humidity, and no condensation or icing.
- The E5ZD may affect radio, television, and other wireless reception if installed nearby.

1-4-3 Operating Precautions

Caution Never touch the E5ZD while the power is turned on or when a ground-type thermocouple is connected, as there is danger of electric shock.

- The E5ZD requires a 24-VDC power supply. Do not reverse the polarity of the power terminals, and confirm that the voltage at the connector on the E5ZD is within power supply ratings (21.6 to 26.4 V). Also be sure that the power supply and wiring have sufficient capacity for the E5ZD. Insufficient capacity will prevent operation of the E5ZD; allow at least twice the rated power supply current.
- Power supply from a half-wave rectifier cannot be used. Use a stabilized power supply.
- Initial settings on the E5ZD's DIP switches must be made before applying power.
- The nonvolatile memory has a limited overwrite life (approximately 10,000 times). Be sure that you have not exceeded this life; doing so will mean that new settings are not saved.

- You must allow at least 10 ms between the host computer receiving a response and it sending the next command.
- If the terminator switch is set incorrectly, current consumption may increase and communications may not be possible. Turn ON the terminator switch only for the terminator, and leave it OFF for all other Units.
- The command which has the longest response time (from the time the command is received until the beginning of the response) is the WE command, which transfers RAM data in blocks. For processing this command, it may take up to 3.5 seconds for the set data to be transferred for Fuzzy-logic Controllers and up to 2.3 seconds for other Controllers. It is therefore necessary, when processing communications, to take into account that the response may be delayed after the command has been transmitted. In addition, if the power is cut before the transmission of the response has been completed, the contents of the settings will not be saved.
- When E5ZD Units are used simultaneously with differing numbers of control points, or if an E5ZD is replaced by another Unit with a different number of control points, then be sure to take that into consideration when creating the program at the host. There may be differences in the number of response data for global read operations depending on the number of control points.
- If you are using °F as the setting unit, there may be a setting error after the DIP switch is changed from °C to °F. This is because the settings that were being used for °C are not automatically converted when the unit is changed to °F, and the °F temperature range may thus be exceeded. For example, suppose that an initial value of 0 is set at the time of factory shipment. If the temperature range is set as 32°F to 752°F for thermocouple K, then the initial value of 0 will be outside of the range and a setting error will be generated. After changing DIP switch settings, you should re-initialize E5ZD settings, clear setting errors and make settings within the correct range, and write the values into nonvolatile memory using the WE command.
- The inputs used to designate the current memory bank are level inputs and must retain their status to maintain the same memory bank designation.
- Do not leave unused inputs, including thermocouple and platinum resistance inputs, unconnected. When not required, connect dummy inputs as follows: thermocouple input, short circuit the positive and negative terminals; platinum resistance input, connect from 100 Ω to 177 Ω between terminals A and B, and short circuit between the B terminals. Leaving these terminals unconnected will result in operating errors.
- With platinum resistance input specifications, there is no insulation between sensor input points.
- There is no insulation between sensor inputs and CT inputs.
- For E5ZD-8H□KJM-E sensor input, it is necessary to use a special terminal block for thermocouple inputs. This special terminal block includes an element which conducts cold junction compensation, and therefore a cold junction compensation error will be generated if the special terminal blocks are not connected both to the connector for points 0 to 3 and the connector for points 4 to 7. If an error is generated, the temperature cannot be controlled at any of the points. Therefore it is necessary to connect two terminal blocks even if only four points are to be used.
- Turn on the power for the heater before activating the HB alarm. If the power for the heater is turned on late, the HB alarm may be turned ON.
- There may be a difference between the rated current for the heater and the current that the heater is actually drawing. When making the setting for the heater burnout detection level, therefore, use the command for measuring the current while the heater is actually used, and then take that value as the basis for making the setting.

- When making the setting for the heater burnout detection level, it is recommended that you set 1 A or more as the difference between normal status and heater-burnout status. If the set value is too small, then detection will be unstable due to the influence of fluctuations in measurement resulting from changes in the ambient temperature of the E5ZD. In addition, fluctuations in the heater's power supply voltage will cause fluctuations in the current, so you must take that into account when setting the heater-burnout detection level.
- The heater-burnout detection function cannot be used when the heater is controlled by either the phase control method or the cycle control method. In addition, it cannot be used for three-phase heaters.
- The E54-CT2 Current Transformer cannot be used with the E5ZD. Be sure to use an E54-CT1 or E54-CT3.
- The control output circuit has a circuit for protection against short-circuiting or overcurrent which is effective regardless of whether the circuit is used as a voltage output or an open collector output. This is only for short-term protection, however, so be sure to correct the problem quickly.
- The following OMRON power supplies are recommended:

Input voltage	Capacity	Output current	Open Construction Models	Models with Covers
100 V	25 W	1.1 A	S82J-0224	S82J-5224
	50 W	2.1 A	S82J-0524	S82J-5524
200 V	25 W	1.1 A	S82J-2224	S82J-6224
	50 W	2.1 A	S82J-2524	S82J-6524

- The E5ZD's alarm 1, alarm 2, HB alarm, HS alarm, temperature controller error alarm, and cooling control outputs (for the heating and cooling output models) are open collector outputs and are not protected from excessive voltages or currents. Therefore, do not impose a voltage or current exceeding 30 VDC or 50 mA on the E5ZD, otherwise the internal circuitry may be damaged.
- When using an HB alarm or HS alarm output, adjust so that the ON/OFF-timing of the control output and those of the actual heater current are synchronized. If the control output is sequenced before being output, there will be a time lag between the ON/OFF-timing of the control output and that of the heater current, and consequently an HB alarm or HS alarm output will be turned ON.
- For stable communications, wait for 3 s or more after turning on the E5ZD and using communications.
- When control operation is stopped, the channel's alarms will be turned OFF.
- The alarm 1, alarm 2, HB alarm, and HS alarm outputs are output for an alarm for any one or more channels.

SECTION 2

Preparations for Operation

This section covers the basic E5ZD components, their functions, switch settings, connector pin allocations, and specifications.

2-1	E5ZD-4□□□-E/-6□□□-E Hardware	10
2-1-1	Component Names and Functions	10
2-1-2	Indicators	12
2-1-3	Connector Allocations and Wiring	13
2-1-4	Communications Interfaces	18
2-1-5	Switch Settings	23
2-2	E5ZD-8□□□-E Hardware	24
2-2-1	Component Names and Functions	24
2-2-2	Connector Allocations and Wiring	26
2-2-3	Terminal Blocks	30
2-2-4	Communications Interfaces	31
2-2-5	Switch Settings	31
2-2-6	Indicators	33
2-3	E5ZD-8H□□M-E Hardware	34
2-3-1	E5ZD-8H□KJM-E System Configuration	34
2-3-2	E5ZD-8H□PM-E System Configuration	36
2-3-3	Component Names and Functions (E5ZD-8H□□M-E)	38
2-3-4	Connector Allocations and Wiring	39
2-3-5	Terminal Blocks for Sensors	44
2-3-6	Terminal Blocks for Control and Alarm Outputs	45
2-3-7	Terminal Blocks for CT and Memory Bank Designation Inputs	46
2-3-8	Sensor Input Precautions	46
2-3-9	Communications Interfaces	47
2-3-10	Switch Settings	47
2-3-11	Indicators	49

2-1 E5ZD-4□□□-E/-6□□□-E Hardware

2-1-1 Component Names and Functions

An outline of the basic components and their functions is provided below. Detailed connector specifications and switch settings are provided in the next two sections. The following diagram shows the external appearance and dimensions of the 4- and 6-point controllers.

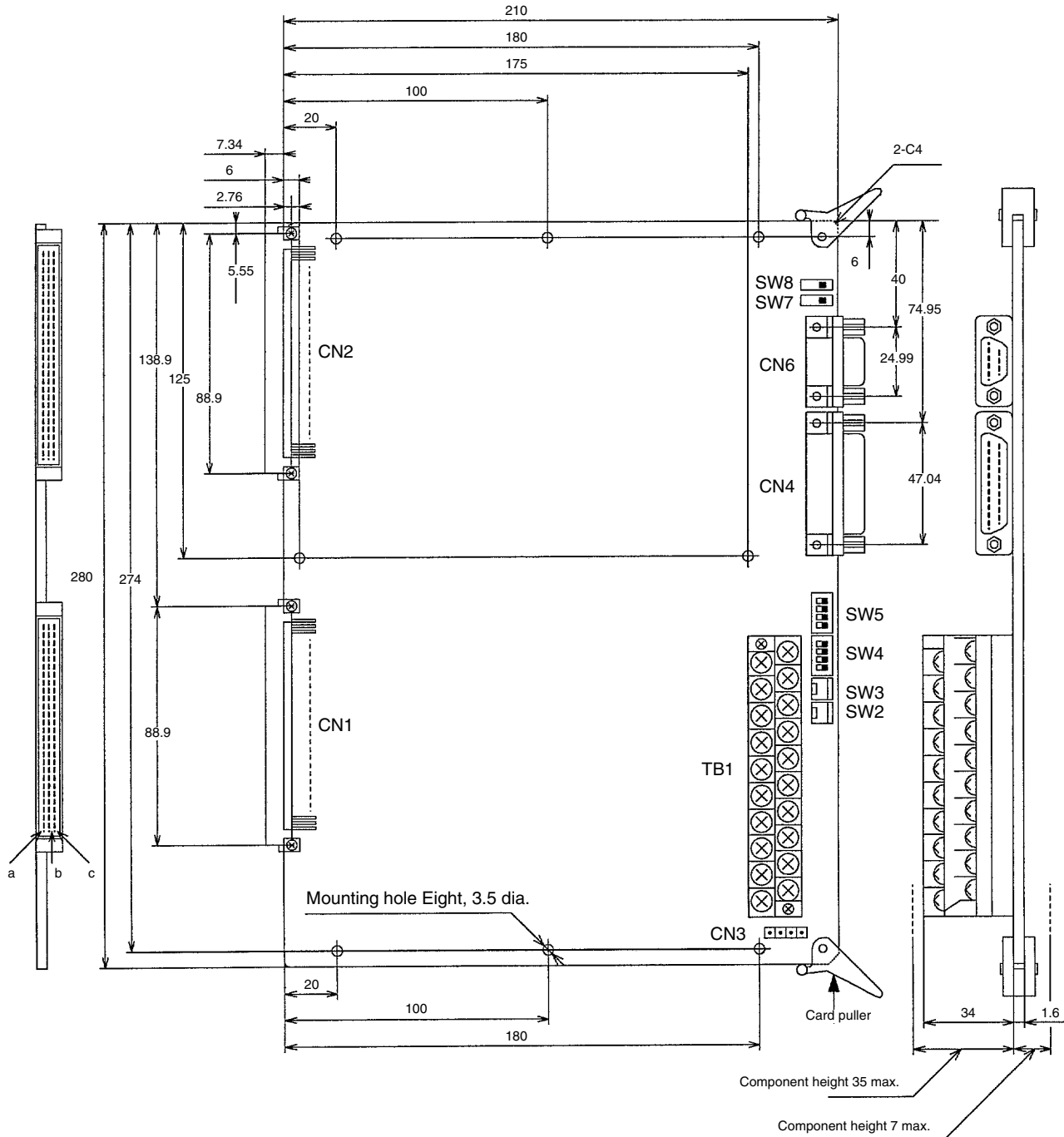

Connectors

CN1

Contains the power supply terminals, the memory bank input terminals, and the control output terminals. The OMRON DIN-compatible connector XC5C-6422, or equivalent, should be used for CN1.

CN2

Contains the alarm output terminals (i.e., the alarm, HB alarm, HS alarm, and error alarm) and the input terminals from the E54-CT1 or E54-CT3 Current Transformer (CT). The OMRON DIN-compatible connector XC5C-6422, or equivalent, should be used for CN2.

CN3

Is used to inspect internal circuits and is not for customer use. Do not touch this connector and do not remove the short pin from between pins 1 and 2. This connector is provided on thermocouple models only.

CN4

Is used for RS-232C communications. The OMRON XM3B-2522-111 connector, or an equivalent, should be used for CN4. This connector is provided on RS-232C models only.

CN6

Is used for RS-422 or RS-485 communications. The OMRON XM3B-0922-111 connector, or an equivalent connector, should be used for CN6. This connector is provided on RS-422 or RS-485 models only.

TB1 (Terminal Block)

Is used to connect the thermocouples or platinum resistance thermometers. The terminal section of this Terminal Block can be removed by loosening the screws on both ends. To re-install that section, alternately tighten the screws little by little.

Switches

The power must be turned off before changing any switch settings. Changes made while the power is on will be invalid.

SW2

Is used to set the unit number that is used to identify the E5ZD during communications.

SW3

Is used to set the baud rate for communications.

SW4

Is used to set the type of sensor being used (i.e., either K or J for thermocouples, and either Pt100 or JPt100 for platinum resistance thermometers) and the control temperature range.

SW5

Is used to set the functions that determine E5ZD operation. These include selection of either normal operation or the communications test (loop-back test), communications or contact inputs designating the current memory banks, the use of Celsius or Fahrenheit, and operation or non-operation when power is turned on.

SW7, SW8

The terminator is the E5ZD Unit located farthest from the host computer. Turn ON SW7 and SW8 (terminator switches) on the terminator with the RS-422 communications specification and SW8 on the terminator with the RS-485 communications specification. SW7 and SW8 on Units other than the terminator must be turned OFF (refer to 2-1-4 Communications Interfaces).

Others

Card Pullers

Are used to remove the E5ZD when it is mounted to a rack. It is not necessary when the E5ZD is screwed in place.

Mounting Screws

There are eight mounting holes provided for mounting the E5ZD.

If you mount the E5ZD-4/6□□□-E with screws, be sure to insert a screw to each of the eight mounting holes on the Unit and secure them tightly, otherwise the Unit cannot maintain proper vibration and shock resistance.

2-1-2 Indicators

The indicators show the I/O status of the 4- and 6-point controllers. Their positions and specific meanings are provided below.

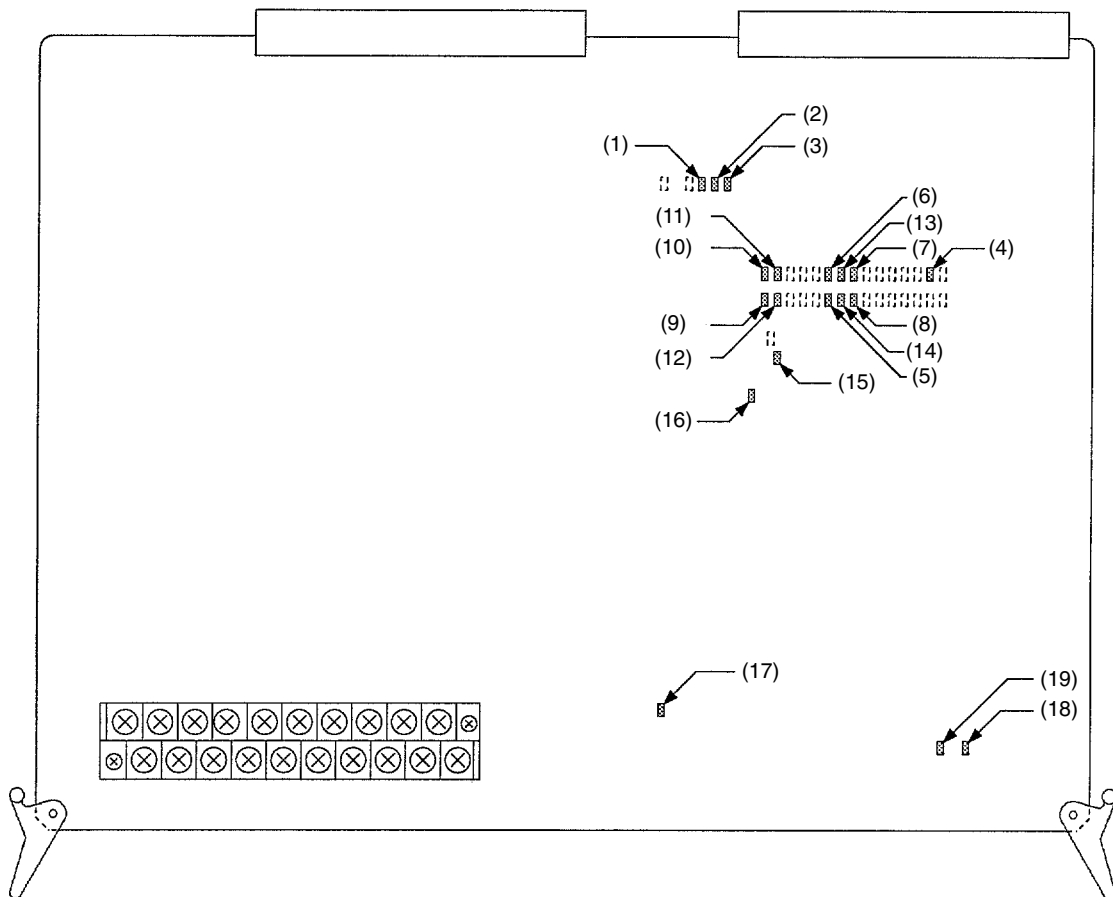

Meanings

No.	Function	Indicator lit.	Indicator not lit.
1	Memory bank 0	Memory bank setting input 2 ⁰ closed.	Memory bank setting input 2 ⁰ open.
2	Memory bank 1	Memory bank setting input 2 ¹ closed.	Memory bank setting input 2 ¹ open.
3	Memory bank 2	Memory bank setting input 2 ² closed.	Memory bank setting input 2 ² open.
4	Temperature Controller alarm output	Output ON	Output OFF
5	HS alarm output	Output ON	Output OFF
6	HB alarm output	Output ON	Output OFF
7	Alarm 2 output	Output ON	Output OFF
8	Alarm 1 output	Output ON	Output OFF
9	Point 0 control output	Output ON	Output OFF
10	Point 1 control output	Output ON	Output OFF
11	Point 2 control output	Output ON	Output OFF
12	Point 3 control output	Output ON	Output OFF
13	Point 4 control output	Output ON	Output OFF
14	Point 5 control output	Output ON	Output OFF
15	Operation monitor 1	Monitors 1 and 2 both lit: Memory error. Monitor 1 not lit, monitor 2 lit: Communications error. (Note 1)	
16	Operation monitor 2	Monitor 1 lit, monitor 2 not lit: Point during AT exists. (Note 2) Monitors 1 and 2 both not lit: None of the above.	
17	Power supply monitor	Power supply ON	Power supply OFF
18	Reception monitor	E5ZD receiving.	E5ZD not receiving.
19	Transmission monitor	E5ZD transmitting.	E5ZD not transmitting.

- Note**
1. This type of error would be a framing error, a parity error, or an overrun error.
 2. AT: Autotuning

2-1-3 Connector Allocations and Wiring

Allocations and wiring guidelines for CN1, CN2, and the Terminal Block are provided on the following pages. CN4 and CN5 are described in the next section, *Communications Interfaces*. CN3 is not for customer use.

CN1

Terminal Assignments

The following table shows the terminal assignments for CN1. The four DC+ terminals are internally connected, as are the four DC– terminals. The three BANK and three ING terminals are used to select the current memory bank as explained following table. As the three ING terminals are internally connected, it does not matter which is used. Do not connect anything to the unused terminals. For the E5ZD-4□□□-E, terminals 30 to 32 are also not used.

- Caution** CTRL□G terminals are common ground terminals connected together internally. Do not short-circuit the CTRL□A terminal and CTRL□G terminal or the internal circuitry may be damaged.

Terminal	Row a (bottom)		Row c (top)	
	Name	Function	Name	Function
1	DC+	24-VDC power supply	DC+	24-VDC power supply
2	DC+	24-VDC power supply	DC+	24-VDC power supply
3	Not used		Not used	
4	DC–	0-VDC power supply	DC–	0-VDC power supply
5	DC–	0-VDC power supply	DC–	0-VDC power supply
6 to 19	Not used		Not used	
20	BANK0	2 ⁰ memory bank designation	BANK1	2 ¹ memory bank designation
21	BANK2	2 ² memory bank designation	ING	Signal input common
22	ING	Signal input common	ING	Signal input common
23	Not used		Not used	
24	CTRL0A	Point 0 control output 0A	CTRL1A	Point 1 control output 1A
25	CTRL0B	Point 0 control output 0B	CTRL1B	Point 1 control output 1B
26	CTRL0G	Point 0 control output 0G	CTRL1G	Point 1 control output 1G
27	CTRL2A	Point 2 control output 2A	CTRL3A	Point 3 control output 3A
28	CTRL2B	Point 2 control output 2B	CTRL3B	Point 3 control output 3B
29	CTRL2G	Point 2 control output 2G	CTRL3G	Point 3 control output 3G
30	CTRL4A	Point 4 control output 4A	CTRL5A	Point 5 control output 5A
31	CTRL4B	Point 4 control output 4B	CTRL5B	Point 5 control output 5B
32	CTRL4G	Point 4 control output 4G	CTRL5G	Point 5 control output 5G

Power Supply Terminals

Power is supplied to the 4- and 6-point controllers through the DC+ and DC– terminals. Connect the DC+ terminals to 24 VDC; the DC– terminals to 0 VDC. The rated voltage (21.6 to 26.4 V) must be supplied to the DIN connector on the E5ZD; these are not switching power-supply terminals.

To ensure activation of the power supply, it is necessary that at least twice the rated current capacity be available when power is turned on.

Memory Bank Terminals

The BANK0, BANK1, BANK2, and three ING terminals can be used to select the memory bank to be used for temperature control. Refer to *Section 3-3 Memory Banks* for operational details. The BANK0, BANK1, and BANK2 terminals are activated by connecting each to a ING terminal. The terminals can be connected either through contacts, e.g., relays, or through transistors or other no-contact devices. The memory banks designated by the various open-closed combinations of these terminals are shown in the following table.

Memory bank	Bank 0	Bank 1	Bank 2	Bank 3	Bank 4	Bank 5	Bank 6	Bank 7
BANK0-ING	Open	Closed	Open	Closed	Open	Closed	Open	Closed
BANK1-ING	Open	Open	Closed	Closed	Open	Open	Closed	Closed
BANK2-ING	Open	Open	Open	Open	Closed	Closed	Closed	Closed

Signal Input Method

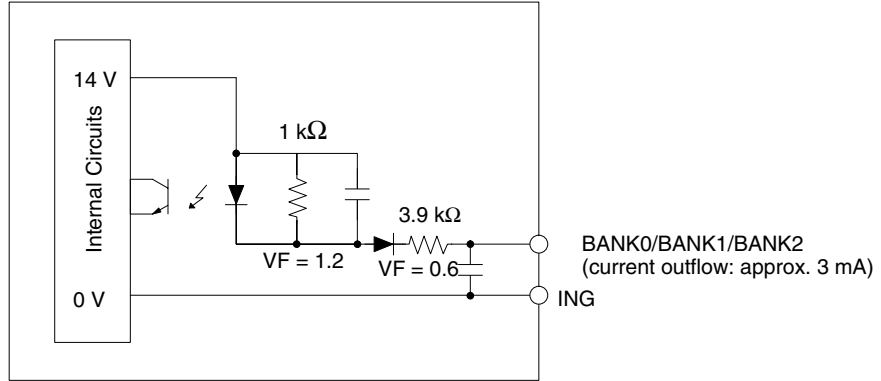

Contact Inputs

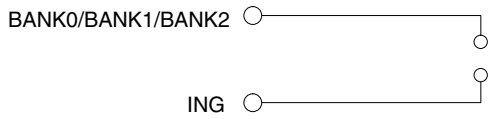

ON: Connection resistance of 1 kΩ max.
 OFF: Open resistance of 100 kΩ min.

No-contact Inputs (Open Collector)

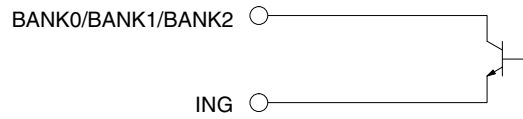

ON: Residual voltage of 2 V max.
 OFF: Leakage current of 1 mA max.

Control Outputs

The control outputs can be wired for independent use as voltage outputs or as open-collector outputs. In either case, a diode must be included in the output circuit to protect the Unit's internal circuits.

Circuit Configuration

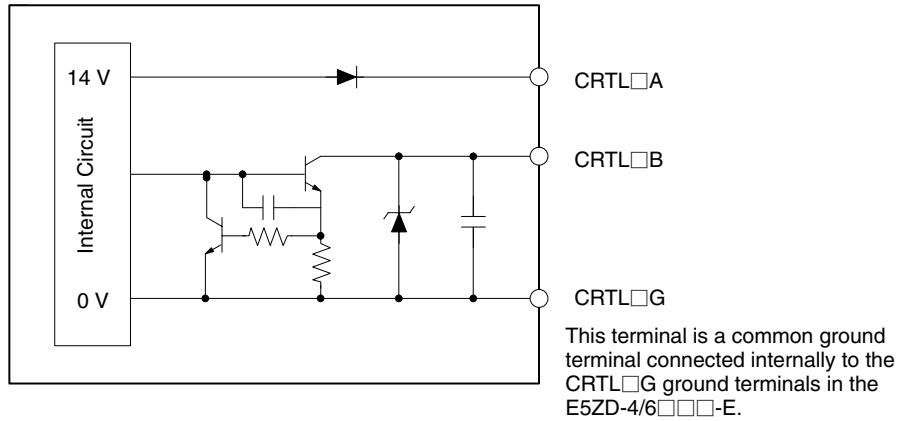

Voltage Outputs



Output voltage: 12 ± 1.2 VDC
 Output current: 30 mA max.

Open Collector Outputs

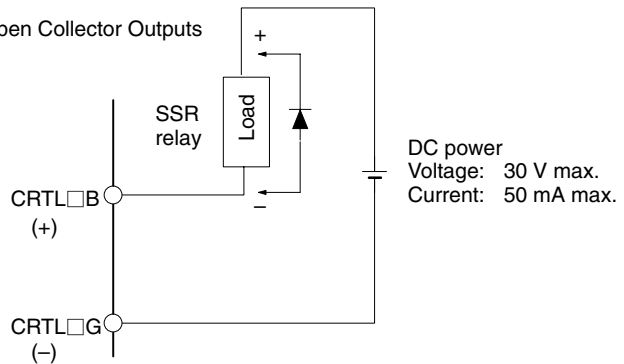

ON: Residual voltage of 2 V max.
 OFF: Leakage current of 1 mA max.

CN2**Terminal Assignments**

The following table shows the terminal assignments for CN2. All alarm and error outputs are open-collector outputs.

Note Open-collector outputs are not protected from excessive current flow; be sure to wire them correctly to protect internal circuits from damage.

ALARM1G and ALARM2G are the emitters and ALARM1 and ALARM2 are the collectors for alarm 1 and alarm 2, respectively. The HB alarm output goes ON when the detected current falls below the set heater current. The HS alarm output goes ON when there is a current flow of 0.5 A or more on the CT when the control output of the E5ZD is OFF. The error output goes ON when an abnormality is detected within the E5ZD. CT terminals are not polarity sensitive and may be connected as desired to the CT input terminals. The same signals as on CN6 are placed on terminals 22 through 24 when RS-422 or RS-485 communications are used. For the E5ZD-4□□□-E, terminals 31 and 32 are also not used.

Terminal	Row a (bottom)		Row b (top)	
	Name	Function	Name	Function
1	ALARM1G	Alarm output 1 (-)	ALARM1	Alarm output 1 (+)
2	ALARM2G	Alarm output 2 (-)	ALARM2	Alarm output 2 (+)
3 to 14	Not used.		Not used.	
15	HBALMG	HB alarm output (-)	HBALM	HB alarm output (+)
16	HSALMG	HS alarm output (-)	HSALM	HS alarm output (+)
17	Not used.		Not used.	
18	TCTRBLG	Error output (-)	TCTRBL	Error output (+)
19 to 21	Not used.		Not used.	
22	SG	RS-422: SG	Not used.	
23	SDA, (-)	RS-422: SDA, RS-485: (-)	SDB, (+)	RS-422: SDB, RS-485: (+)
24	RDA	RS-422: RDA	RDB	RS-422: RDB
25 and 26	Not used.		Not used.	
27	CT0	Point 0 CT input	CT0	Point 0 CT input
28	CT1	Point 1 CT input	CT1	Point 1 CT input
29	CT2	Point 2 CT input	CT2	Point 2 CT input
30	CT3	Point 3 CT input	CT3	Point 3 CT input
31	CT4	Point 4 CT input	CT4	Point 4 CT input
32	CT5	Point 5 CT input	CT5	Point 5 CT input

CT Inputs

CT terminals are not polarity sensitive and may be connected as desired to the CT input terminals.

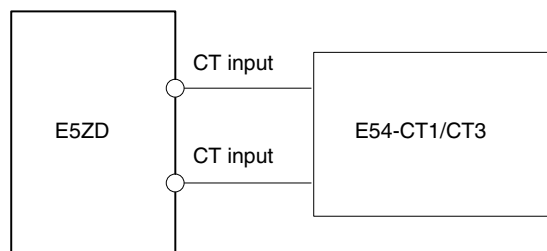
**Sensor Connections**

Temperature sensor lead wires are connected to TB1 as shown below. Be sure to secure the lead wires so that they do not come into contact with E5ZD components.

E5ZD-4/6□□KJ-E Models

Do not use terminals 5, 6, 11, 12, 17, 18, and 20. Using these terminals may result in internal damage.

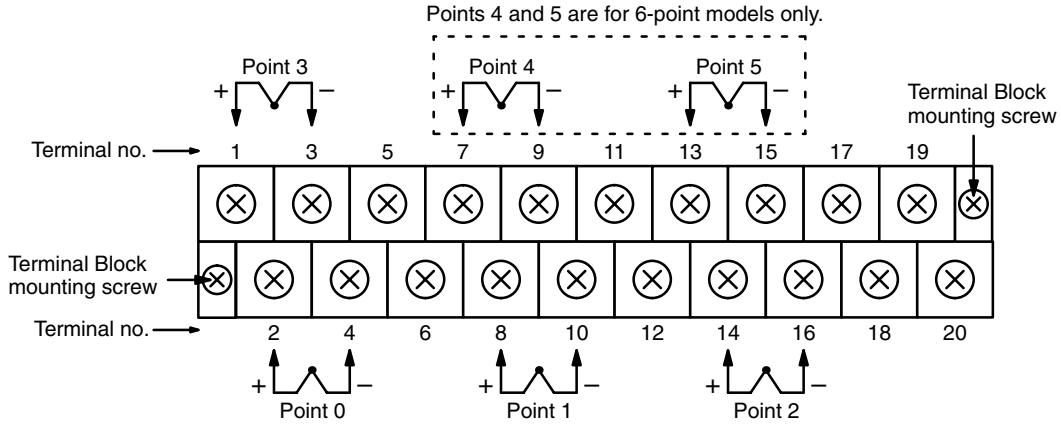

E5ZD-4/6□□P-E Models

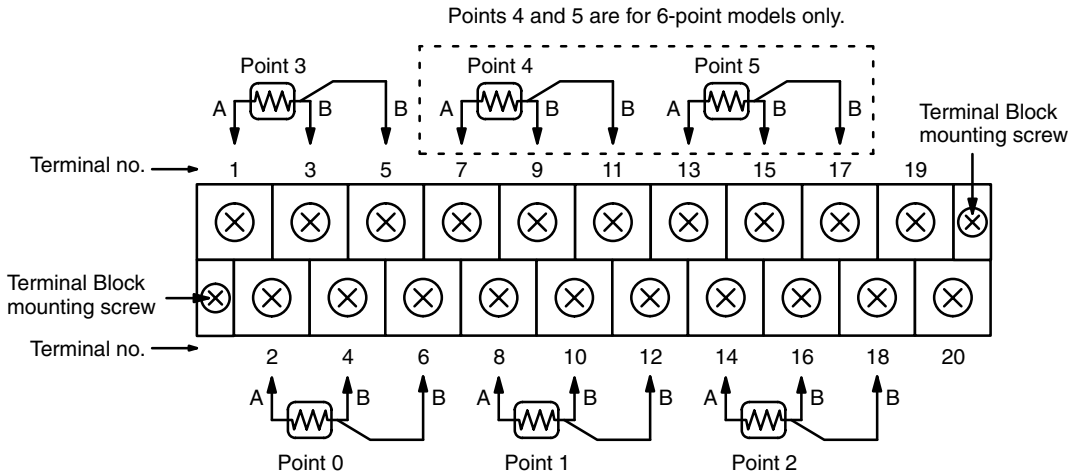

Connecting Terminals

Do not over-tighten terminal screws. When using crimp-type terminals, use those designed for M3.5 screws (M3.5 x 8, self-rising terminal screws are used). When using soldered wire tips, connection is facilitated by the self-rising screws; expose 6 to 8 mm of wire and prepare it carefully.

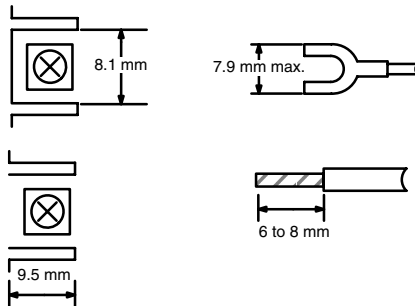

Unused Points

Terminals for unused points must never be left unconnected, regardless of whether they are for thermocouples or for platinum resistance thermometers.

For a thermocouple input, short circuit the + and – terminals. The measured temperature will be that of the Terminal Block.

For platinum resistance thermometer inputs, place a resistor with an operating resistance of 100 to 177Ω (within the specified temperature range) between terminals A and B for the same point, and then short circuit the B terminals. The measured temperature will be determined by the connected resistance.

2-1-4 Communications Interfaces

This section provides specifications for the communications interfaces.

General Specifications

The following specifications apply to all of the three types of communication: RS-232C, RS-422, and RS-485.

Transmission path connections	Multipoint
Transmission method	Half duplex
Sync	Start-stop (asynchronous)
Baud rate	150, 300, 600, 1,200, 2,400, 4,800, or 9,600 bps (set via DIP switch)
Error detection	Vertical parity and frame check sequence (FCS)
Interfaces	RS-232C, RS-422, or RS-485
Character length	7-bit ASCII
Stop bits	2
Parity check	Even
Terminal definition	Data terminal equipment (DTE)
Data structure	As shown below



Signal Identification

Signal voltage at the terminals can be identified as follows:

Interface	Signal Voltage	Data Signal
RS-232C	High level	0 (space)
	Low level	1 (mark)
RS-422	SDA > SDB	0 (space)
	SDA < SDB	1 (mark)
RS-485	⊖ > ⊕	0 (space)
	⊖ < ⊕	1 (mark)

RS-232C Interface

Pin assignments and specifications for RS-232C communications are provided below.

- Electrical characteristics: Conform to EIA RS-232C

- Signal connections:

As shown below

Signal name	Symbol	Direction	Pin
Field ground	FG	NA	1
Signal ground	SG	NA	7
Send data	SD	Output	2
Receive data	RD	Input	3
Send request	RS	Output	4
Send enable	CS	Input	5
Data set ready	DR	Input	6
Data terminal ready	ER	Output	20

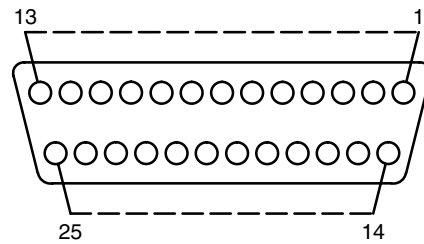

RS-232C Pin Assignments

- Connection diagram: As shown below

You cannot connect the host computer directly to more than one E5ZD Unit via the RS-232C connectors.

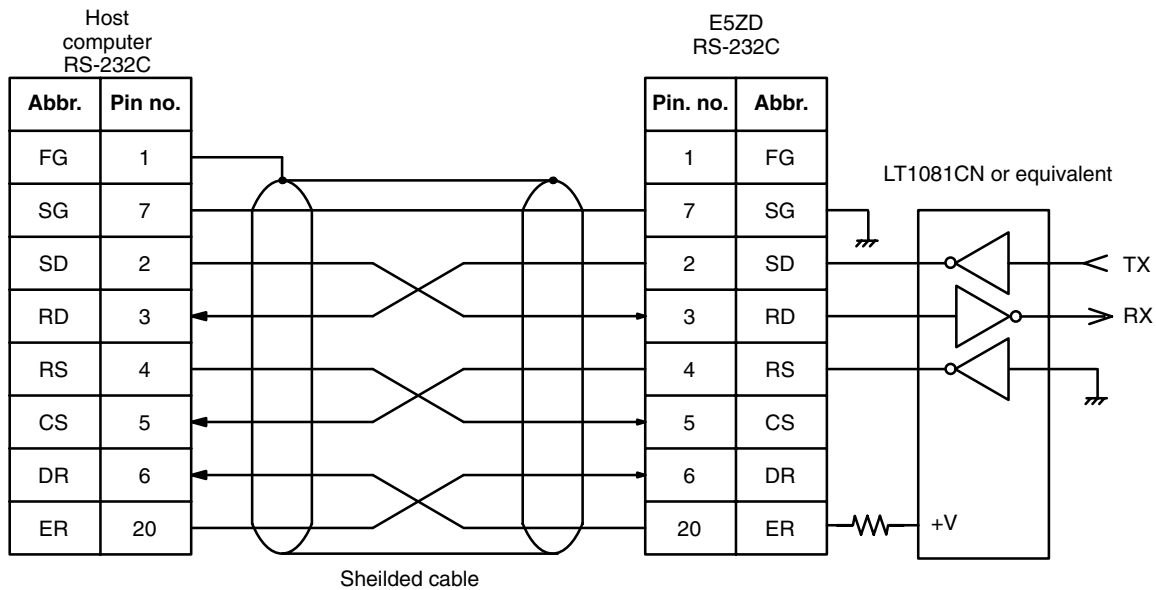

- **Sync clock:** Internal
- **Transmission length:** 15 m max. (OMRON's RS-232C optical interface (Z3RN) can be used for longer transmissions.)
- **Applicable connectors:** Plug, XM2A-2501; hood, XM2S-2511 (OMRON) or equivalent
- **Connections:** 1:1 only (when connecting directly between the host computer and the E5ZD with RS-232C)

Caution The E5ZD's RS-232C does not support a CD (carrier detect) signal from the host computer. If CD support is required, pull it up at the host computer. CD is not required with OMRON's FC-984 Factory Computer.

Caution Output circuits and contact input circuits are not electrically insulated from the transmission circuits in 4- and 6-point controllers.

RS-422 Interface

Pin assignments and specifications for RS-422 communications are provided below.

- Electrical characteristics: Conform to EIA RS-422
- Signal connections: As shown below

Signal name	Symbol	Direction	Pin
Send data A	SDA	Output	9
Send data B	SDB	Output	5
Receive data A	RDA	Input	6
Receive data B	RDB	Input	1
Signal ground	SG	NA	3

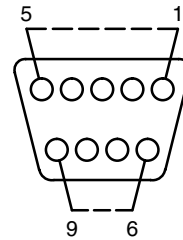

RS-422 Pin Assignments

- Connection diagram:
You can use RS-422 to connect up to 16 controllers to one host.

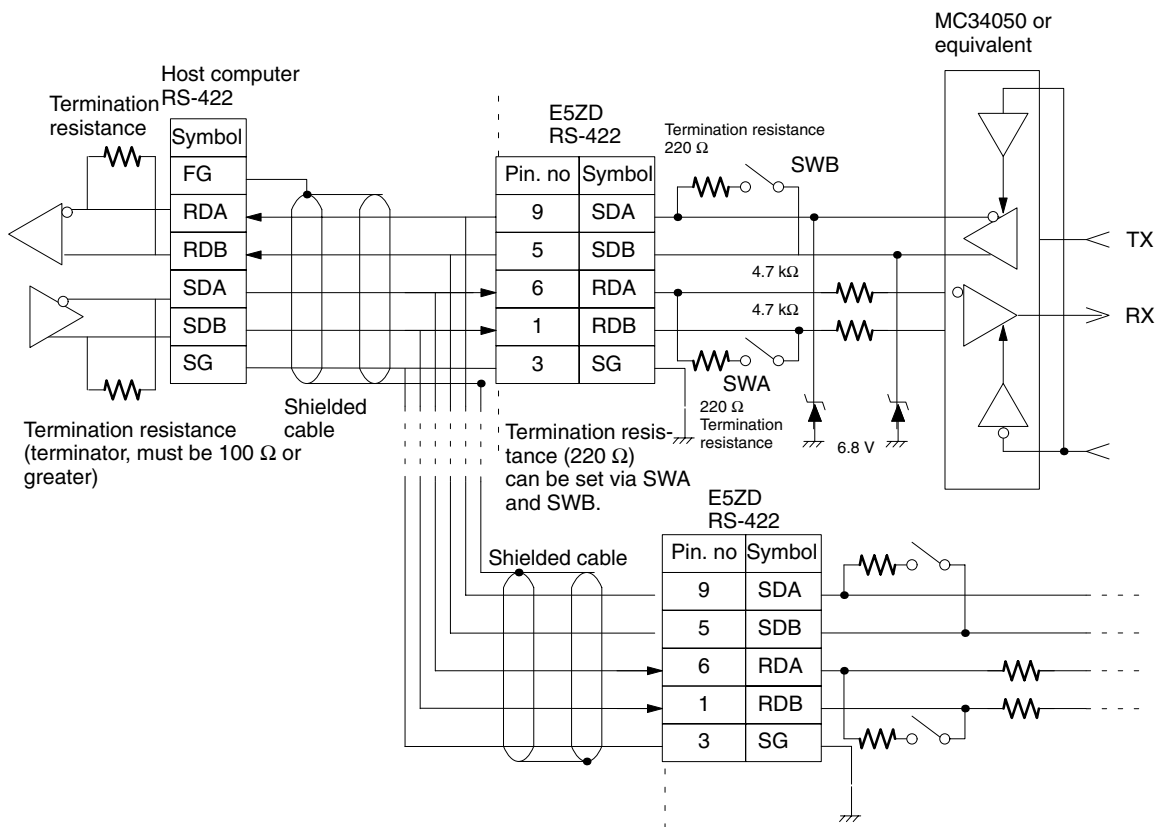

- Sync clock: Internal
- Transmission length: 500 m total max.
- Terminator switches: E5ZD-4/-6□□02□-E: SWB corresponds to SW8.
E5ZD-8□□02□-E: SWB corresponds to SW508.
E5ZD-8H02□M-E: SWB corresponds to SW508.
- Applicable connectors: Plug, XM2A-0901; hood, XM2S-0911 (OMRON) or equivalent
- Connections: Up to 1:16

Caution Output circuits and contact input circuits are not electrically insulated from the transmission circuits in 4- and 6-point controllers.

Caution Turn ON the terminator switches (SWA and SWB) on the E5ZD Unit located farthest from the host computer, and turn these switches OFF on all other Units. Communications will not operate correctly if the terminator switch settings are wrong.

System Configuration Example

The diagram shown here illustrates a case in which several E5ZD-□□02□□-E Controllers are connected to a personal computer. For details on Link Adapters, refer to the catalog or to the Link Adapter operation manual.

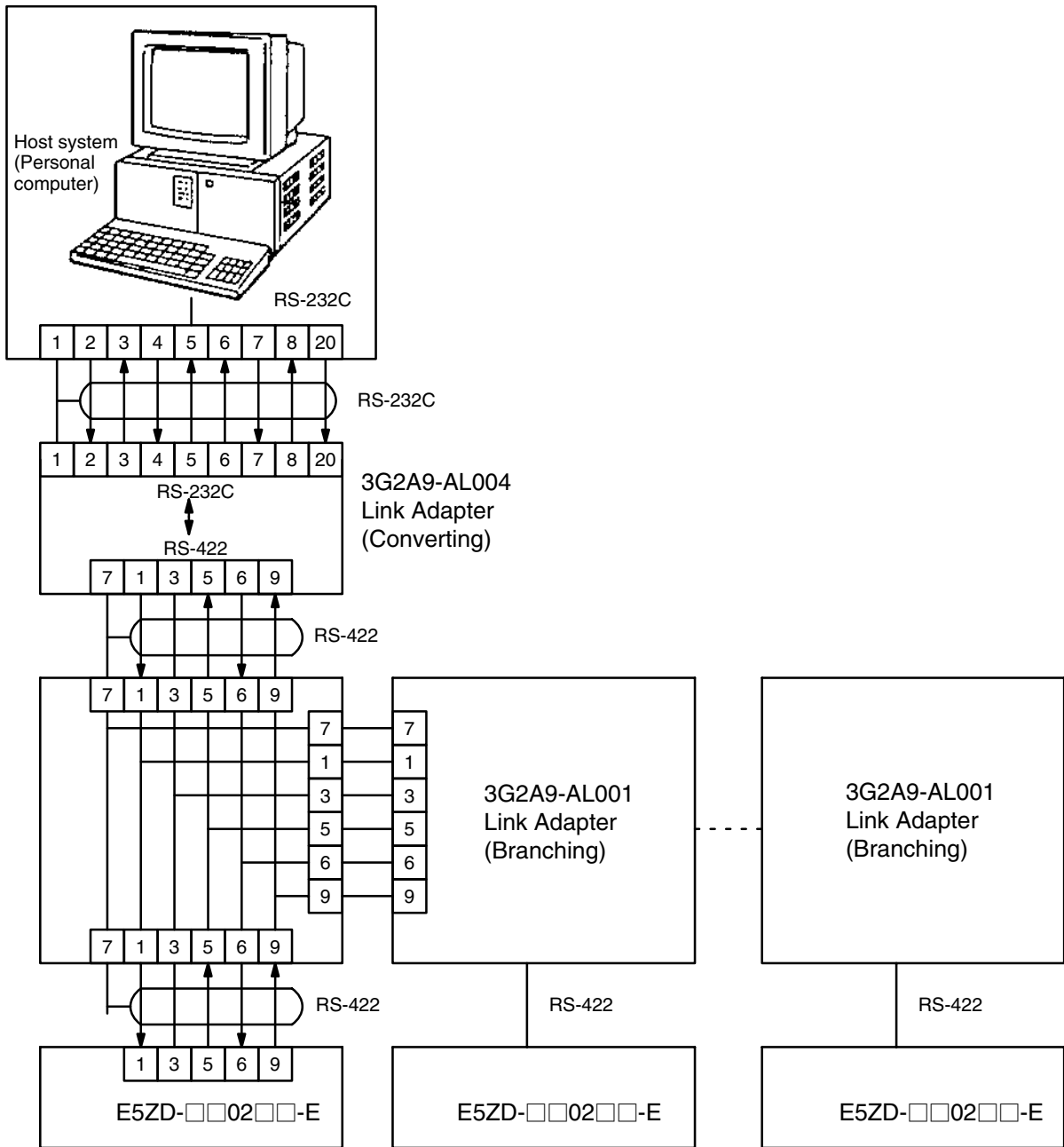

RS-485 Interface

Pin assignments and specifications for RS-485 communications are provided below.

- Electrical characteristics: Conform to EIA RS-485

- Signal connections: As shown below

Signal name	Symbol	Direction	Pin
Terminal A	-	I/O	9
Terminal B	+	I/O	5
Signal ground	SG	NA	3

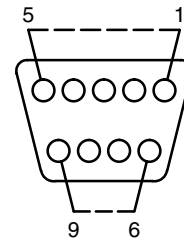

RS-485 Pin Assignments

- Connection diagram: You can use RS-485 to connect up to 16 Controllers to one host.

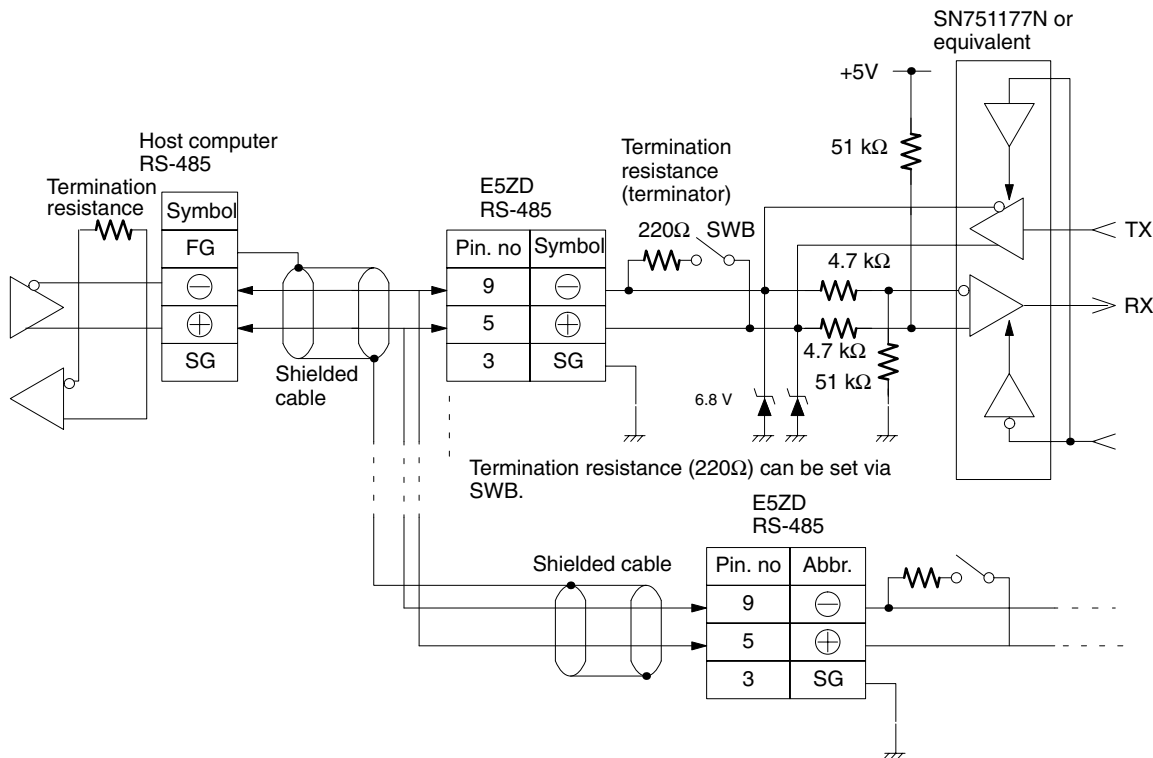

- Sync clock: Internal
- Transmission length: 500 m total max.
- Terminator switches: E5ZD-4/6□□03□-E: SWB corresponds to SW8.
E5ZD-8□□03□-E: SWB corresponds to SW508.
E5ZD-8H03□M-E: SWB corresponds to SW508.
- Applicable connectors: Plug, XM2A-0901; hood, XM2S-0911 (OMRON) or equivalent
- Connections: Up to 1:16

Caution Outputs circuits and contact input circuits are not electrically insulated from the transmission circuits.

Caution Turn ON the terminator switches (SW8) on the E5ZD Unit located farthest from the host computer.

2-1-5 Switch Settings

For the following switch settings to be effective, they must be made with the power to the E5ZD turned OFF, i.e., the switch status is read only when the power is turned ON.

Unit Number: SW2

Each E5ZD-4/6□□□-E Temperature Controller is assigned a unit number to enable easy identification of the Units during communications with the host computer. The unit number (from 0 to F) is set using SW2. When multiple E5ZDs are connected to the same host computer, the same unit number must not be set for more than one E5ZD. The unit number is set to 0 at the factory.

Baud Rate: SW3

The baud rate determines the transmission speed for communications with the host computer. The host computer must be set to the same baud rate as the E5ZD for communications to be possible. Set SW3 to between 0 and 6 to set the baud rate according to the following table. Do not set SW3 to between 7 and 9.

SW3 setting	0	1	2	3	4	5	6	7 to 9
Baud rate	150	300	600	1,200	2,400	4,800	9,600	Not allowed.

Sensor Specifications: SW4 Set pins 1 and 2 of SW4 to establish the type of sensor and the temperature range. Leave pins 3 and 4 OFF. All pins are set to OFF at the factory. For E5ZD-4□□□P-E/E5ZD-6□□□P-E, pin 1 is set to ON at the factory. The Celsius/Fahrenheit setting is made on SW5.

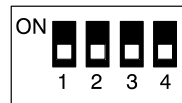

SW 4



ON

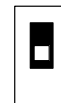

OFF

E5ZD-4/6□□KJ-E

Pin	Function	ON	OFF
1	Sensor type	J	K
2	Temperature range	0° to 600°C (32° to 1112°F)	0° to 400°C (32° to 752°F)

E5ZD-4/6□□P-E

Pin	Function	ON	OFF
1	Sensor type	Pt100	JPt100
2	Temperature range	0° to 500°C (32° to 932°F)	-100.0° to 200.0°C (-148.0° to 392.0°F)

Function Switch: SW5

Determines some of the basic operating parameters of the E5ZD, as shown in the following table. These settings are described below. Switch appearance and pin number are the same as SW4, shown above. All pins are set to OFF at the factory.

Pin	Function	ON	OFF
1	Operation mode	Test	Normal
2	Memory bank designation	Contact inputs	Communications
3	Unit of measure	Fahrenheit	Celsius
4	Initial status	Operating	Non-operating

Pin 1

Determines whether the normal operation mode or the communications test mode (the mode in which the loop-back test is executed) is to be used. If pin 1 is set to ON and then power is applied to the E5ZD, the communications test mode will be used and the following character string will be sent continuously until the power is cut. Reception should be confirmed at the host computer. A loop-back test will be conducted simultaneously to see whether the E5ZD can receive the transmitted data back again. If it cannot receive the data back just as it was transmitted, a Temperature Controller alarm output will turn ON.

E5ZD_Copyright_1990_OMRON_Corporation (carriage return)
└─ Space

Pin 2

Determines whether the current memory bank is to be set according to input status or via communications from the host computer. If pin 2 is set to ON before power is turned ON, the status of the BANK0, BANK1, BANK2, and ING terminals will determine the current memory bank. If pin 2 is OFF, the current memory bank will be determined according to commands sent from the host computer.

Pin 3

Determines whether Fahrenheit or Celsius is to be used. (Fahrenheit and Celsius can be manually converted via this equation: °F = 1.8 × °C + 32.)

Pin 4

Determines E5ZD operation in response to power interruptions during control operation. If pin 4 is set to ON, operation will continue immediately after power is restored following a power interruption. If pin 4 is set to OFF, operation will not automatically restart following power interruptions.

2-2 E5ZD-8□□□-E Hardware

2-2-1 Component Names and Functions

An outline of the basic components and their functions is provided below. Detailed connector specifications and switch settings are provided in the next two

sections. The following diagram shows the external appearance and dimensions of an 8-point Controller without heater burnout detection.

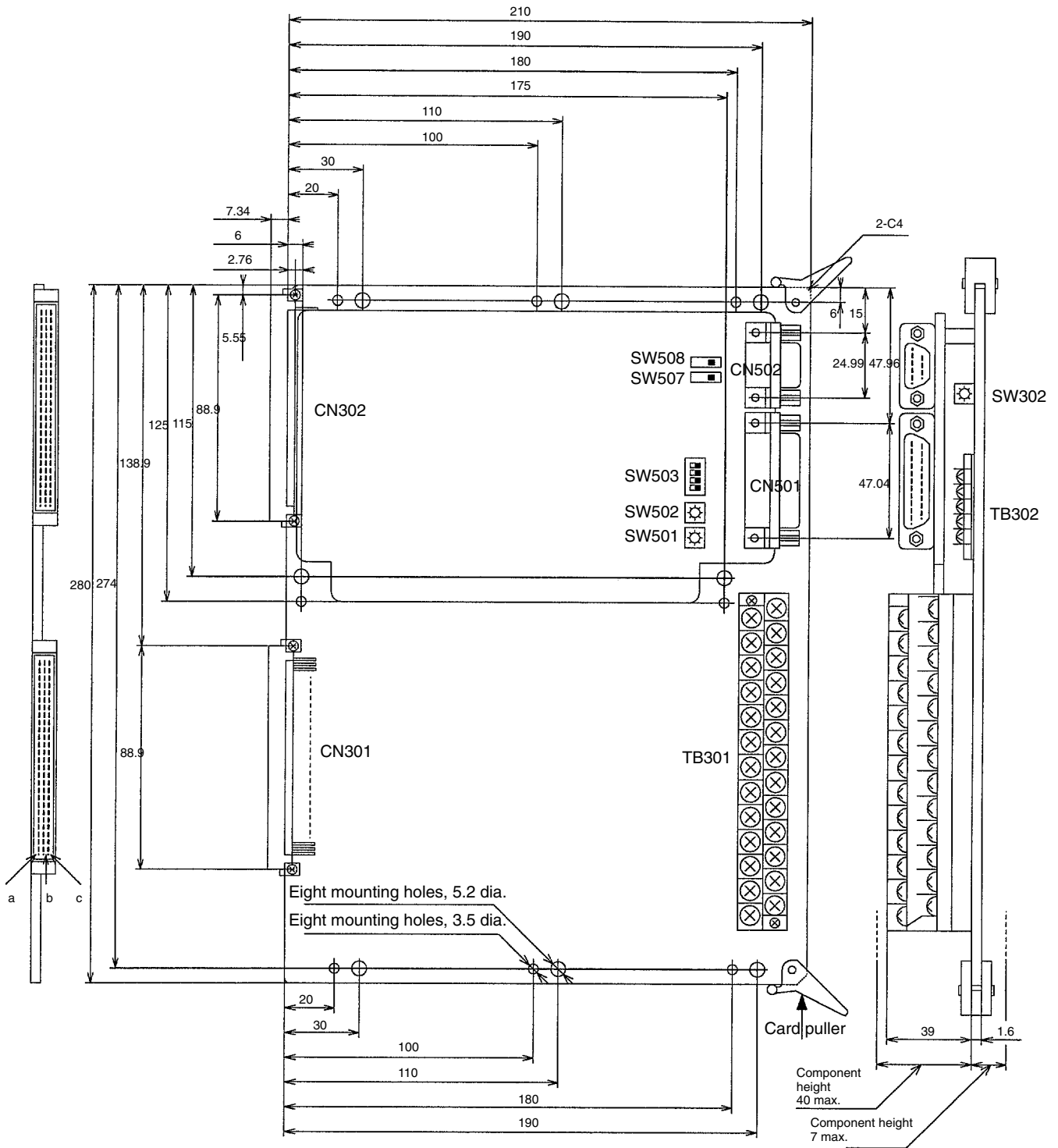

Connectors

CN301

Contains the power supply terminals, the memory bank input terminals, and the control output terminals for an 8-point Controller without heater burnout detection. The OMRON DIN-compatible connector XC5C-6422 or equivalent should be used for CN301.

CN302

Contains the alarm output terminals (i.e., the alarm, HB alarm, HS alarm, and error alarm), the input terminals from the E54-CT1 or E54-CT3 Current Transformer (CT). The OMRON DIN-compatible connector XC5C-6422 or equivalent should be used for CN302.

CN501

Is used for RS-232C communications and is provided only on Controllers that support RS-232C communications. The OMRON XM3B-2522-111 connector or equivalent should be used for CN501.

CN502

Is used for RS-422 or RS-485 communications and is provided only on Controllers that support RS-422/485 communications. The OMRON XM3B-0922-111 connector or equivalent should be used for CN501.

TB301 (Terminal Block)

Is used to connect the thermocouples or platinum resistance thermometers. The terminal section of this Terminal Block can be removed by loosening the screws on both ends. To reinstall that section, alternately tighten the screws little by little.

Switches

The power must be turned off before changing any switch settings. Changes made while the power is on will be invalid.

SW302

Is used to set the unit number that is used to identify the E5ZD-8H□□□M-E during communications.

SW501

Is used to set the baud rate for communications.

SW502

Is used to set the type of sensor being used (i.e., either K or J for thermocouples, and either Pt100 or JPt100 for platinum resistance thermometers) and the control temperature range.

SW503

Is used to set the functions that determine E5ZD-8H□□□M-E operation. These include selection of either normal operation or the communications test (loop-back test), communications or inputs designating the current memory banks, the use of Celsius or Fahrenheit, and operation or non-operation when power is turned on.

SW507 and SW508

Are terminator switches for activating the termination resistance when RS-422 or RS-485 communications are used. The switch must be on at the terminator. (i.e. the E5ZD Controller located farthest from the host computer).

Others**Card Pullers**

Are used to remove the E5ZD-8□□□-E when it is mounted to a rack. It is not necessary when the E5ZD-8□□□-E is screwed in place.

Mounting Screws

There are eight mounting holes provided for mounting the E5ZD-8□□□-E.

2-2-2 Connector Allocations and Wiring

Allocations and wiring guidelines for CN1, CN2, and the Terminal Block are provided on the following pages. CN4 and CN5 are described in the *Section 2-1-4 Communications Interfaces*. CN3 is not for customer use.

CN301**Terminal Assignments**

The following table shows the terminal assignments for CN301. The four DC+ terminals are internally connected, as are the four DC- terminals. The three

BANK and three ING terminals are used to select the current memory bank as explained following the table. As the three ING terminals are internally connected, it does not matter which is used. Do not connect anything to the unused terminals.

Caution CTRL□G terminals are common ground terminals connected together internally. Do not short-circuit the CTRL□A terminal and CTRL□G terminal or the internal circuitry may be damaged.

Terminal	Row a (bottom)		Row b (top)	
	Name	Function	Name	Function
1	DC+	24-VDC power supply	DC+	24-VDC power supply
2	DC+	24-VDC power supply	DC+	24-VDC power supply
3	Not used		Not used	
4	DC-	0-VDC power supply	DC-	0-VDC power supply
5	DC-	0-VDC power supply	DC-	0-VDC power supply
6 to 16	Not used		Not used	
17	BANK0	2^0 memory bank designation	BANK1	2^1 memory bank designation
18	BANK2	2^2 memory bank designation	ING	Signal input common
19	ING	Signal input common	ING	Signal input common
20	Not used		Not used	
21	CTRL0A	Point 0 control output 0A	CTRL1A	Point 1 control output 1A
22	CTRL0B	Point 0 control output 0B	CTRL1B	Point 1 control output 1B
23	CTRL0G	Point 0 control output 0G	CTRL1G	Point 1 control output 1G
24	CTRL2A	Point 2 control output 2A	CTRL3A	Point 3 control output 3A
25	CTRL2B	Point 2 control output 2B	CTRL3B	Point 3 control output 3B
26	CTRL2G	Point 2 control output 2G	CTRL3G	Point 3 control output 3G
27	CTRL4A	Point 4 control output 4A	CTRL5A	Point 5 control output 5A
28	CTRL4B	Point 4 control output 4B	CTRL5B	Point 5 control output 5B
29	CTRL4G	Point 4 control output 4G	CTRL5G	Point 5 control output 5G
30	CTRL6A	Point 6 control output 6A	CTRL7A	Point 7 control output 7A
31	CTRL6B	Point 6 control output 6B	CTRL7B	Point 7 control output 7B
32	CTRL6G	Point 6 control output 6G	CTRL7G	Point 7 control output 7G

CN302

Terminal Assignments

The following table shows the terminal assignments for CN302. All alarm and error outputs are open-collector outputs.

Note Open-collector outputs are not protected from excessive current flow; be sure to wire them correctly to protect internal circuits from damage.

ALARM1G and ALARM2G are the emitters and ALARM1 and ALARM2 are the collectors for alarm 1 and alarm 2, respectively. The HB alarm output goes ON when the detected current falls below the set heater current. The HS alarm output goes ON when there is a current flow of 0.5 A or more on the CT when the control output of the E5ZD is OFF. The error output goes ON when an abnormal-

ity is detected within the E5ZD. CT terminals are not polarity sensitive and may be connected as desired to the CT input terminals.

Terminal	Row a (bottom)		Row c (top)	
	Name	Function	Name	Function
1	ALARM1G	Alarm output 1 (-)	ALARM1	Alarm output 1 (+)
2	ALARM2G	Alarm output 2 (-)	ALARM2	Alarm output 2 (+)
3 to 14	Not used.		Not used.	
15	HBALMG	HB alarm output (-)	HBALM	HB alarm output (+)
16	HSALMG	HS alarm output (-)	HSALM	HS alarm output (+)
17	Not used.		Not used.	
18	TCTRBLG	Error output (-)	TCTRBL	Error output (+)
19 to 24	Not used.		Not used.	
25	CT0	Point 0 CT input	CT0	Point 0 CT input
26	CT1	Point 1 CT input	CT1	Point 1 CT input
27	CT2	Point 2 CT input	CT2	Point 2 CT input
28	CT3	Point 3 CT input	CT3	Point 3 CT input
29	CT4	Point 4 CT input	CT4	Point 4 CT input
30	CT5	Point 5 CT input	CT5	Point 5 CT input
31	CT6	Point 6 CT input	CT6	Point 6 CT input
32	CT7	Point 7 CT input	CT7	Point 7 CT input

Power Supply Terminals

Power is supplied to the 8-point controllers through the DC+ and DC- terminals. Connect the DC+ terminals to 24 VDC; the DC- terminals to 0 VDC. The rated voltage (21.6 to 26.4 VDC) must be supplied to the DIN connector on the E5ZD; these are not switching power-supply terminals.

To ensure activation of the power supply, it is necessary that at least twice the rated current capacity be available when power is turned on.

Memory Bank Terminals

The BANK0, BANK1, BANK2, and three ING terminals can be used to select the memory bank to be used for temperature control. Refer to *Section 3-3 Memory Banks* for operational details. The BANK0, BANK1, and BANK2 terminals are activated by connecting each to a ING terminal. The terminals can be connected either through contacts, e.g., relays, or through transistors or other no-contact devices. The memory banks designated by the various open-closed combinations of these terminals are shown in the following table.

Memory bank	Bank 0	Bank 1	Bank 2	Bank 3	Bank 4	Bank 5	Bank 6	Bank 7
BANK0-ING	Open	Closed	Open	Closed	Open	Closed	Open	Closed
BANK1-ING	Open	Open	Closed	Closed	Open	Open	Closed	Closed
BANK2-ING	Open	Open	Open	Open	Closed	Closed	Closed	Closed

Signal Input Method

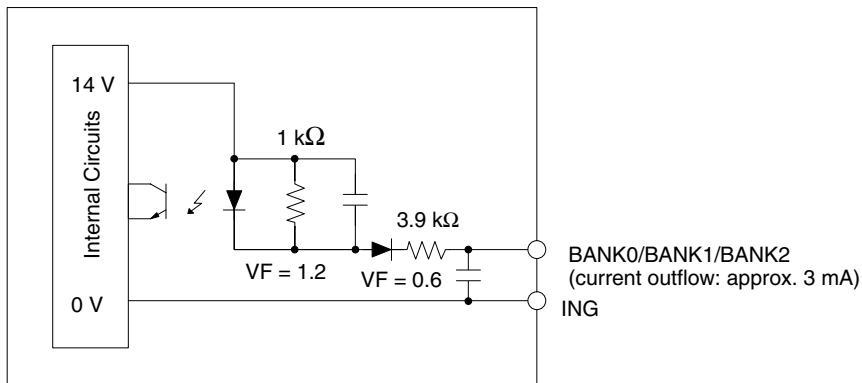

Contact Inputs

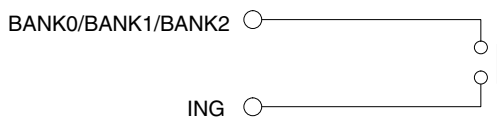

ON: Connection resistance of 1 kΩ max.
 OFF: Open resistance of 100 kΩ min.

No-contact Inputs (Open Collector)

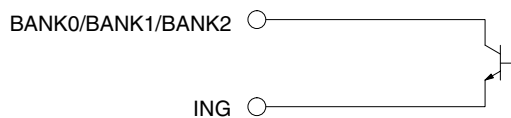

ON: Residual voltage of 2 V max.
 OFF: Leakage current of 1 mA max.

Control Outputs

The control outputs can be wired for independent use as voltage outputs or as open-collector outputs. In either case, a diode must be included in the output circuit to protect the Unit's internal circuits.

Circuit Configuration

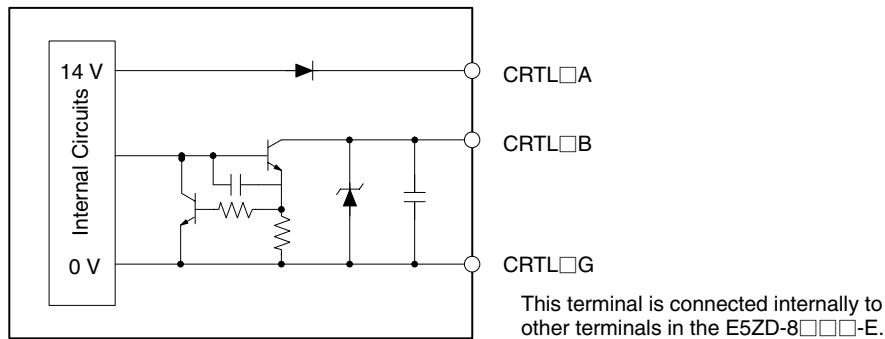

Voltage Outputs

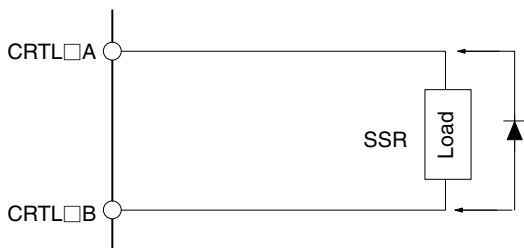

Output voltage: 12 ±1.2 VDC
 Output current: 30 mA max.

Open Collector Outputs

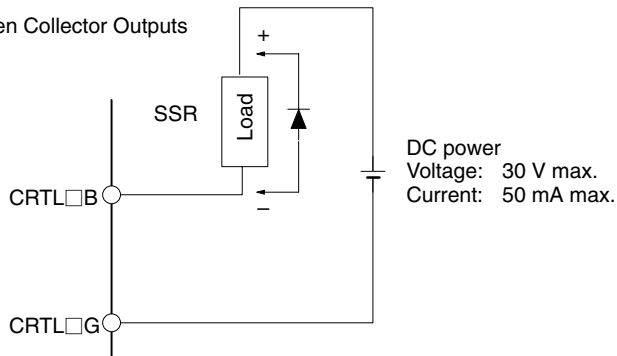

ON: Residual voltage of 2 V max.
 OFF: Leakage current of 1 mA max.

All alarm and error outputs are open-collector outputs. The connection methods of these outputs are the same as those of the open-collector control outputs.

Caution Alarm and error outputs are not protected from excessive current flow and voltage (exceeding 50 mA at 30 VDC); be sure to wire them correctly to protect internal circuits from damage.

CT Inputs

CT terminals are not polarity sensitive and may be connected as desired to the CT input terminals.

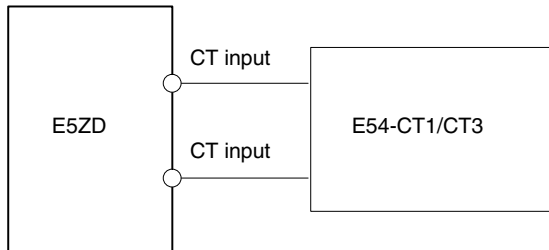

2-2-3 Terminal Blocks

The Terminal Blocks are wired as described below.

Sensor Connections (TB301) Temperature sensor lead wires are connected as shown below. Be sure to secure the lead wires so they do not come into contact with E5ZD components.

E5ZD-8□□KJ-E Models

Do not use terminals 5, 6, 11, 12, 17, 18, and 23 through 26. Using these terminals may result in internal damage, so leave them open.

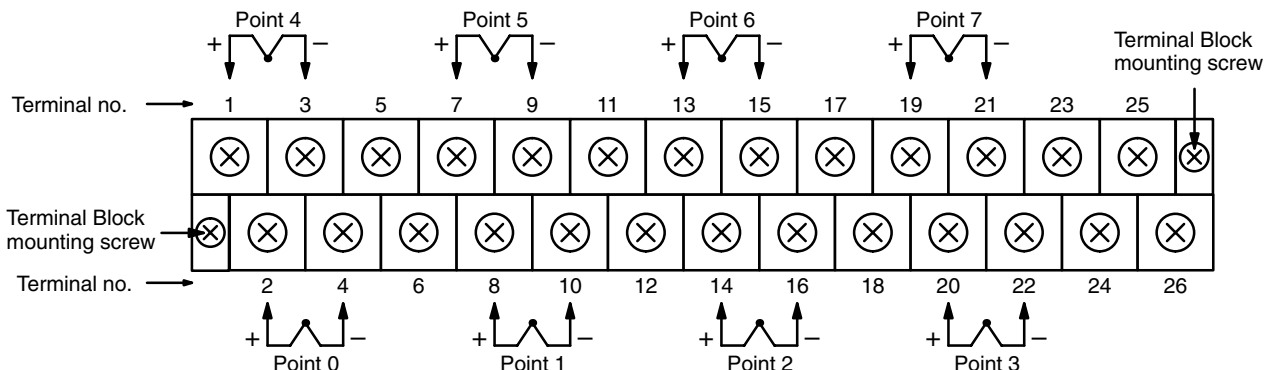

E5ZD-8□□P-E Models

Do not use terminals 25 and 26. Using these terminals may result in internal damage, so leave them open.

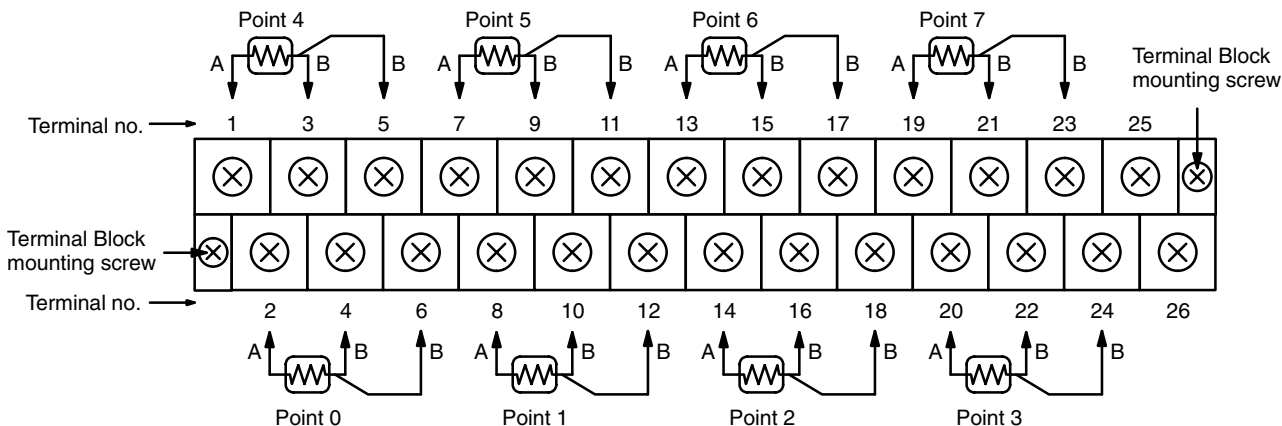

Communications (TB302)

Terminal Block TB302 can be used for communications. The wiring for communications is easy when several 8-point Controllers are connected in parallel. The screw size for the terminals is M3.

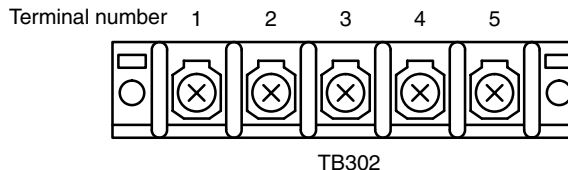

Terminal	RS-422		RS-485	
	Name	Abbrev.	Name	Abbrev.
1	Receive data B	RDB		
2	Receive data A	RDA		
3	Signal ground	SG	Signal ground	
4	Send data	SDB	Terminal B	+
5	Send data	SDA	Terminal A	-

Terminal Connection

Do not tighten the terminal screws with excessive force. Each terminal screw is a M3.5 × 8 screw. Use crimp-style terminals that are fit for the terminal screws. Before you connect PVC lead wires to the terminals, bare each lead wire 6 to 8 mm from the end by removing the PVC insulation cover, and then apply solder to the lead wire surface for a smooth connection.

2-2-4 Communications Interfaces

E5ZD-8□□□-E specifications for the communications interfaces are the same as those for 4- and 6-point controllers. Return to 2-1-4 *Communications Interfaces* for the specifications.

2-2-5 Switch Settings

For the following switch settings to be effective, they must be made with the power to the E5ZD turned OFF, i.e., the switch status is read only when the power is turned ON.

Unit Number: SW302

Each E5ZD-8□□□-E Temperature Controller is assigned a unit number to enable easy identification of the various Units during communications with the host computer. The unit number (from 0 to F) is set using SW302. When multiple E5ZDs are connected to the same host computer, the same unit number must not be set for more than one E5ZD. The unit number is set to 0 at the factory.

Baud Rate: SW501

The baud rate determines the transmission speed for communications with the host computer. The host computer must be set to the same baud rate as the E5ZD for communications to be possible. Set SW501 to between 0 and 6 to set the baud rate according to the following table. Do not set SW501 to between 7 and 9.

SW3 setting	0	1	2	3	4	5	6	7 to 9
Baud rate	150	300	600	1,200	2,400	4,800	9,600	Not allowed.

Sensor Specifications: SW502

Set these pins to establish the type of sensor and the temperature range to be used. Pins 4 to 9 are not used, so leave them OFF. All pins are set to 0 at the factory, so the K setting will be 0°C to 400°C for thermocouple specifications,

and the Pt100 setting will be -100.0°C to 200.0°C for platinum resistance thermometer specifications. The Celsius/Fahrenheit setting is made on SW503.

E5ZD-8□□KJ-E

Pin	0	1	2	3
Sensor type	K		J	
°C	0° to 400°C	0° to 600°C	0° to 400°C	0° to 600°C
°F	32° to 752°F	32° to 1112°F	32° to 752°F	32° to 1112°F

E5ZD-8□□P-E

Pin	0	1	2	3
Sensor type	Pt100		JPt100	
°C	-100.0° to 200.0°C	0° to 500°C	-100.0° to 200.0°C	0° to 500°C
°F	-148.0° to 392.0°F	32° to 932°F	-148.0° to 392.0°F	32° to 932°F

Function Switch: SW503

SW503 determines some of the basic operating parameters of the E5ZD, as shown in the following table. These settings are described below. Switch appearance and pin number are the same as SW502, shown above. All pins are set to OFF at the factory.

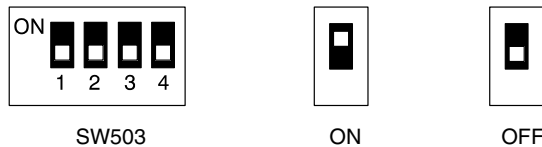

Pin	Function	ON	OFF
1	Operation mode	Test	Normal
2	Memory bank designation	Inputs	Communications
3	Unit of measure	Fahrenheit	Celsius
4	Initial status	Operating	Non-operating

Pin 1

Pin 1 determines whether the normal operation mode or the communications test mode (the mode in which the loop-back test is executed) is to be used. If pin 1 is set to ON and then power is applied to the E5ZD, the communications test mode will be used and the following character string will be sent continuously until the power is cut. Reception should be confirmed at the host computer. A loop-back test will be conducted simultaneously to see whether the E5ZD can receive the transmitted data back again. If it cannot receive the data back just as it was transmitted, a Temperature Controller alarm output will turn ON.

E5ZD_Copyright_1991_OMRON_Corporation (carriage return)

Pin 2

Pin 2 determines whether the current memory bank is to be set according to input status or via communications from the host computer. If pin 2 is set to ON before power is turned ON, the status of the BANK0, BANK1, BANK2, and ING terminals will determine the current memory bank. If pin 2 is OFF, the current memory bank will be determined according to commands sent from the host computer.

Pin 3

Pin 3 determines whether Fahrenheit or Celsius is to be used. (Fahrenheit and Celsius can be manually converted via this equation: °F = 1.8 × °C + 32.)

Pin 4

Pin 4 determines E5ZD operation in response to power interruptions during con-

trol operation. If pin 4 is set to ON, operation will continue immediately after power is restored following a power interruption. If pin 4 is set to OFF, operation will not automatically restart following power interruptions.

2-2-6 Indicators

The indicators show the I/O status of the 8-point controllers. Their positions and specific meanings are provided below.

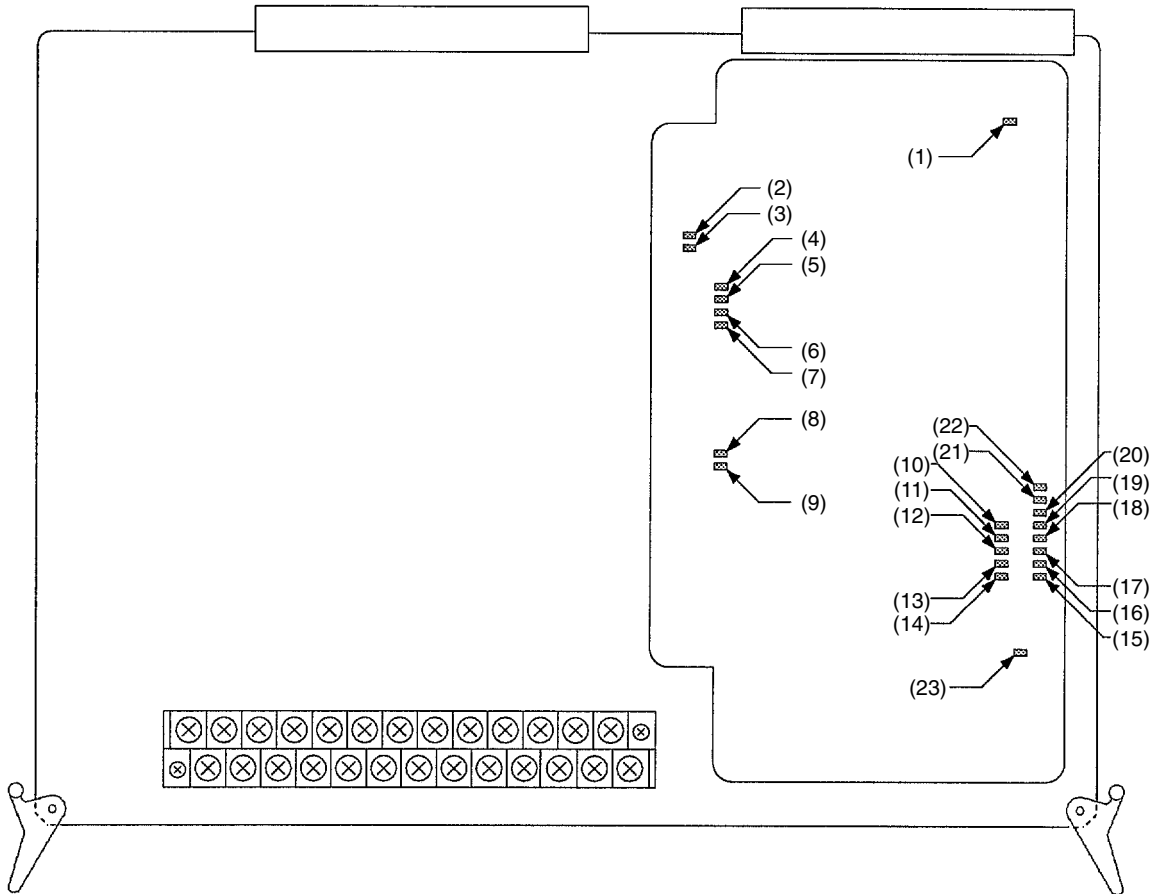

Meanings

No.	Function	Indicator lit.	Indicator not lit.
1	Reset Monitor	CPU resetting. (Note 1)	CPU operating.
2	Operation monitor 1	Monitors 1 and 2 both lit: Memory error. Monitor 1 not lit, monitor 2 lit: Communications error. (Note 2) Monitor 1 lit, monitor 2 not lit: Point exists during AT. (Note 3) Monitors 1 and 2 both not lit: None of the above.	
3	Operation monitor 2		
4	Memory bank 0	Memory bank setting 2 ⁰ input.	Memory bank setting 2 ⁰ open.
5	Memory bank 1	Memory bank setting 2 ¹ input.	Memory bank setting 2 ¹ open.
6	Memory bank 2	Memory bank setting 2 ² input.	Memory bank setting 2 ² open.
7	Not used		
8	Reception monitor	E5ZD receiving.	E5ZD not receiving.
9	Transmission monitor	E5ZD transmitting.	E5ZD not transmitting.
10	Temperature Controller alarm output	Output ON	Output OFF
11	HS alarm output	Output ON	Output OFF
12	HB alarm output	Output ON	Output OFF
13	Alarm 2 output	Output ON	Output OFF
14	Alarm 1 output	Output ON	Output OFF
15	Point 0 control output	Output ON	Output OFF
16	Point 1 control output	Output ON	Output OFF
17	Point 2 control output	Output ON	Output OFF
18	Point 3 control output	Output ON	Output OFF
19	Point 4 control output	Output ON	Output OFF
20	Point 5 control output	Output ON	Output OFF
21	Point 6 control output	Output ON	Output OFF
22	Point 7 control output	Output ON	Output OFF
23	Power supply monitor	Power supply ON	Power supply OFF

- Note**
1. During E5ZD-8□□□-E CPU resetting, the E5ZD will not operate and cannot communicate. The reset indicator will light for approximately 1 second after the power is applied or after a malfunction due to a cause such as noise.
 2. This type of error would be a framing error, a parity error, or an overrun error.
 3. AT: Autotuning

2-3 E5ZD-8H□□M-E Hardware

2-3-1 E5ZD-8H□KJM-E System Configuration

The E5ZD-8H□KJM-E has connectors for thermocouple input and output, so the Terminal Block can be connected by a cable and positioned in a remote location. When a Terminal Block or an I/O Relay Terminal is connected to any of the connectors (CN324 to CN327), GT9-□□□C cable must be used. Placing the cable in the vicinity of machines which emit noise or where there are electrical surges can cause malfunctioning, so separate them as much as possible from such areas and ground both ends with shielding.

Thermocouple Inputs (CN324, CN325)

CN324 and CN325 connect Terminal Blocks for thermocouple inputs. E54-TR011 Terminal Blocks can be used. If these special Terminal Blocks are not used, a cold contact error will be generated and the temperature cannot be controlled.

CN324 is for sensor input from points 0 to 3, and CN325 is for sensor input from points 4 to 7.

Memory Bank Designation and CT Inputs (CN326)

CN326 connects through-type Terminal Blocks. XW2B-20G4 or XW2B-20G5 Terminal Blocks can be used. When E54-CT1 or E54-CT3 Current Transformers

are used for detecting HB or HS alarms, or memory bank designation input is executed with external contacts, they are connected to the contacts.

Control Outputs and Alarm Outputs (CN327)

CN327 connects I/O Terminals or through-type Terminal Blocks. The I/O Terminals that can be connected are G7TC-OC16, G7TC-OC08, and G7VC-OC16. The relays for each Output Terminal can be replaced by SSR. When a G7TC-OC08 is connected, there are only eight I/O points so alarms cannot be used. Only control outputs can be used. XW2B-20G4 and XW2B-20G5 through-type Terminal Blocks can be connected to obtain signals directly.

System Configuration with Thermocouple Inputs

In a System with thermocouple input specifications (E5ZD-8H□KJM-E), any of the Terminal Blocks or I/O Relay Terminals shown inside of the dotted lines can be connected.

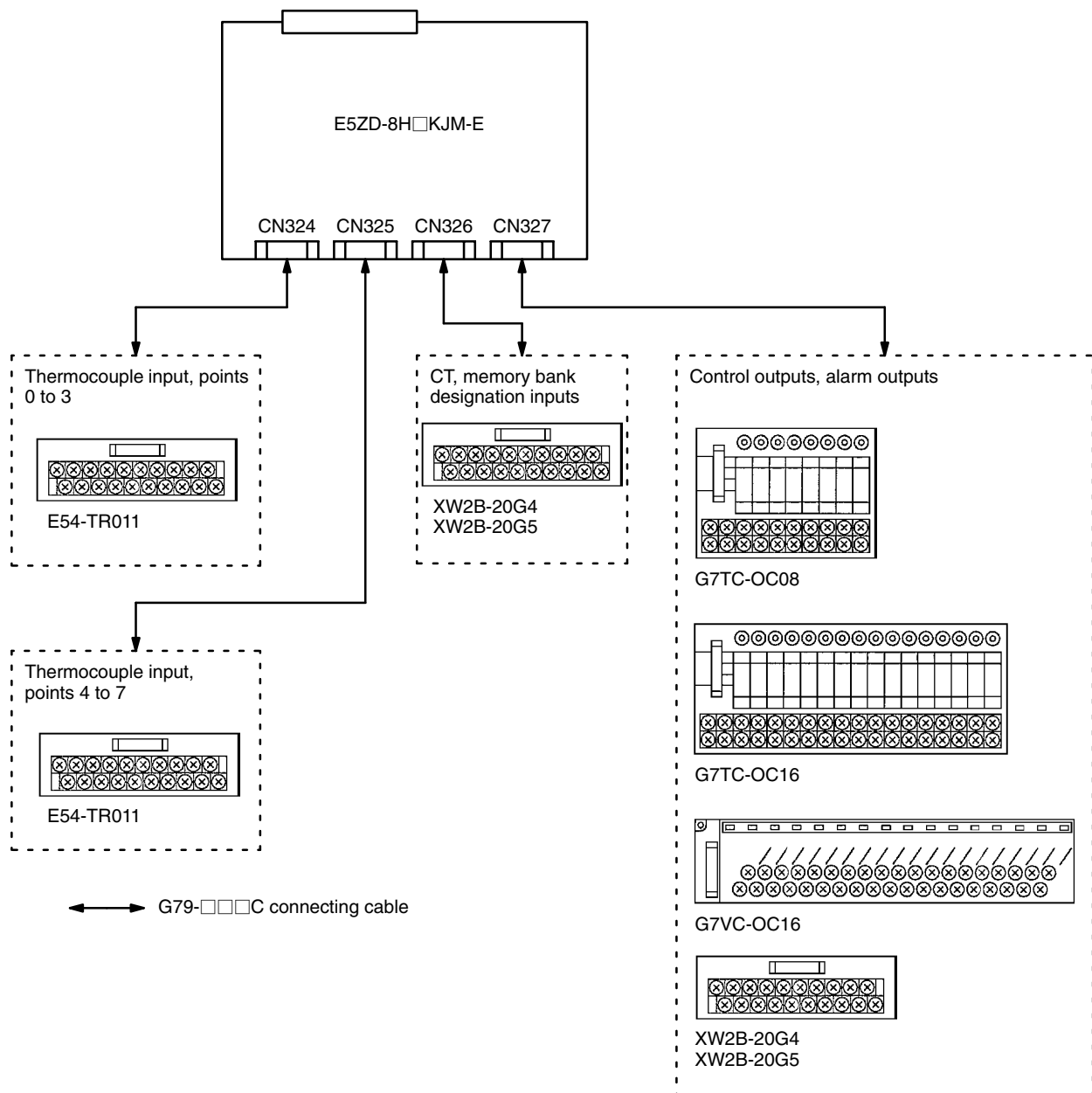

2-3-2 E5ZD-8H□PM-E System Configuration

The E5ZD-8H□PM-E has connectors for platinum resistance thermometer input and output, so the Terminal Block can be connected by a cable and positioned in a remote location. When a Terminal Block or an I/O Relay Terminal is connected to any of the connectors (CN324 to CN327), GT9-□□□C cable must be used. Placing the cable in the vicinity of machines which emit noise or where there are electrical surges can cause malfunctioning, so separate them as much as possible from such areas and ground both ends with shielding.

Platinum Resistance Thermometer Inputs (CN324, CN325)

CN324 and CN325 connect through-type Terminal Blocks. XW2B-20G4 and XW2B-20G5 Terminal Blocks can be used.

CN324 is for sensor input from points 0 to 3, and CN325 is for sensor input from points 4 to 7.

Memory Bank Designation and CT Inputs (CN326)

CN326 connects through-type Terminal Blocks. XW2B-20G4 or XW2B-20G5 Terminal Blocks can be used. When E54-CT1 or E54-CT3 Current Transformers are used for detecting HB or HS alarms, or memory bank designation input is executed with external contacts, they are connected to the contacts.

Control Outputs and Alarm Outputs (CN327)

CN327 connects I/O Terminals or through-type Terminal Blocks. The I/O Terminals that can be connected are G7TC-OC16, G7TC-OC08, and G7VC-OC16. The relays for each Output Terminal can be replaced by SSR. When a G7TC-OC08 is connected, there are only eight I/O points so alarms cannot be used. Only control outputs can be used. XW2B-20G4 and XW2B-20G5 through-type Terminal Blocks can be connected to obtain signals directly.

System Configuration with Platinum Resistance Thermometer Inputs

In a System with platinum resistance thermometer input specifications (E5ZD-8H□PM-E), any of the Terminal Blocks or I/O Relay Terminals shown inside of the dotted lines can be connected.

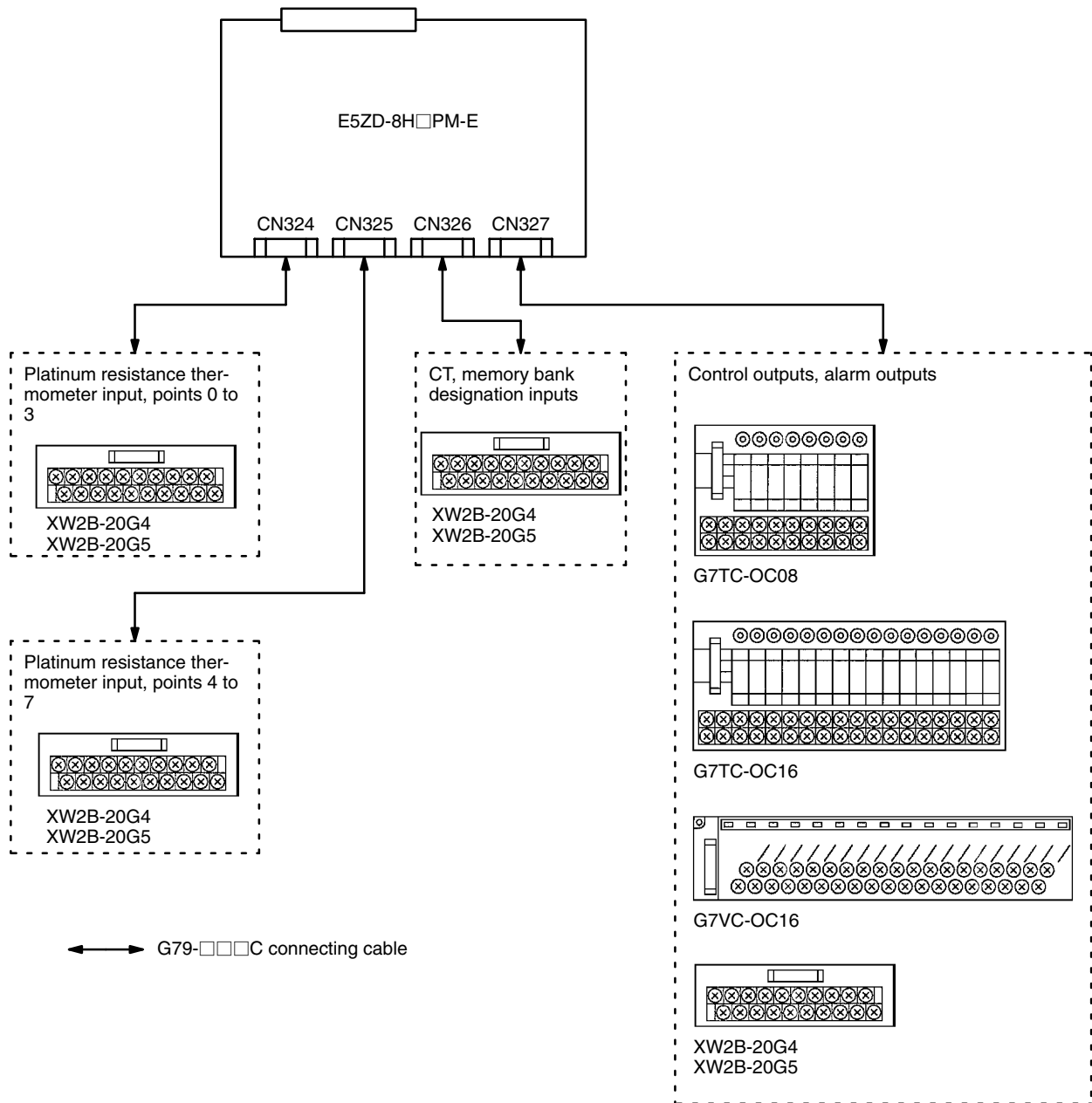

2-3-3 Component Names and Functions (E5ZD-8H M-E)

An outline of the basic components and their functions is provided below. Detailed connector specifications and switch settings are provided later. The following diagram shows the external appearance and dimensions of an 8-point Controller with heater burnout detection.

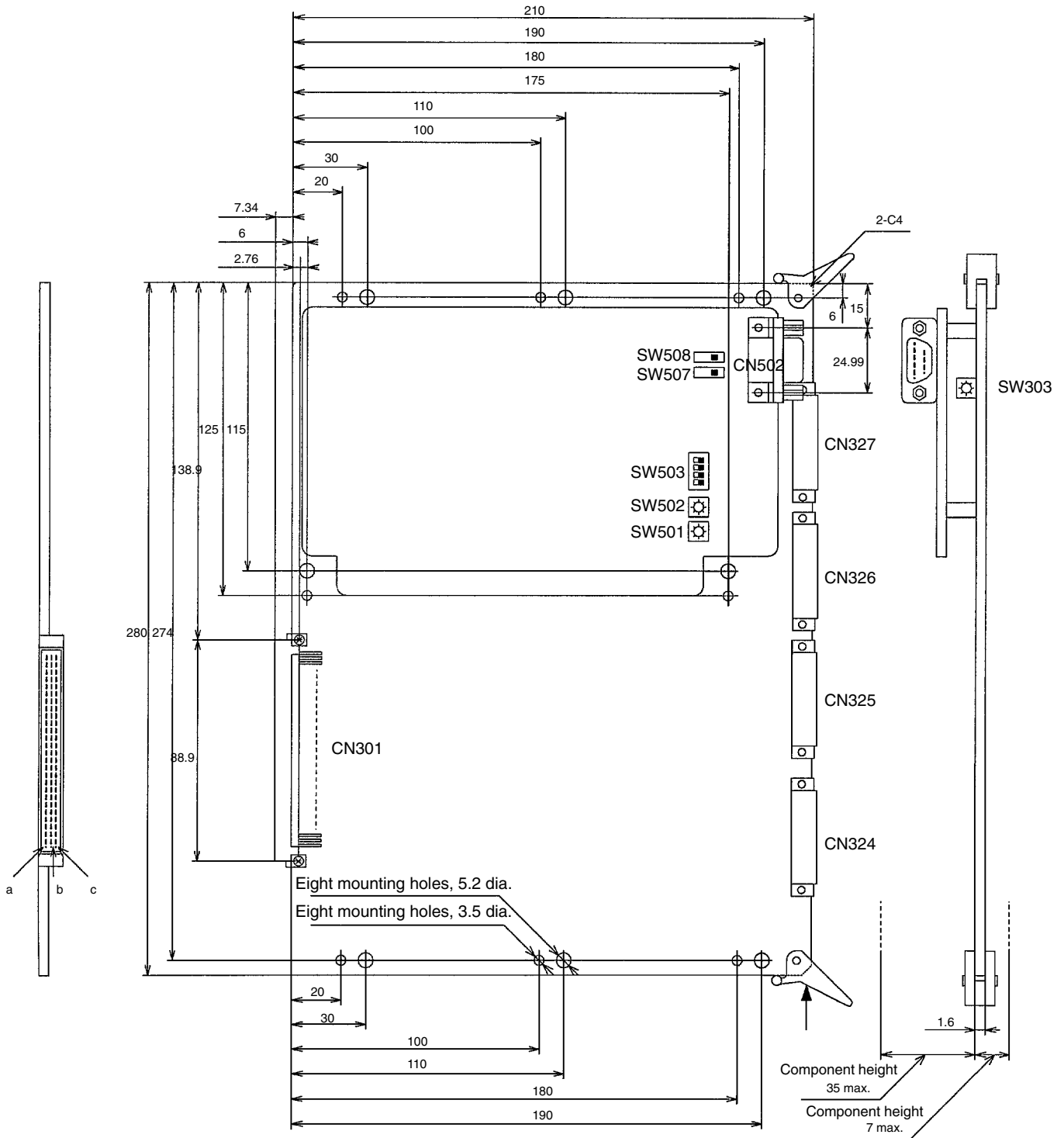

Connectors**CN301**

Contains the power supply terminals and the RS-422 or RS-485 communications for an 8-point Controller with heater burnout detection. The OMRON DIN-compatible connector XC5C-6422 or equivalent should be used for CN301.

CN324 and CN325

Are used for sensor input. G79-□□□ cable should be used for connecting Terminal Blocks either for thermocouple input (E54-TR011) or for platinum resistance thermometer input (XW2B-20G4 or XW2B-20G5).

CN326

Has terminals for connecting E54-CT1 or E54-CT3 Current Transformers and for memory bank designation inputs. G79-□□□ cable should be used for connecting XW2B-20G4 or XW2B-20G5 Terminal Blocks.

CN327

Has output terminals for control outputs, Alarm 1 and Alarm 2 outputs, HB alarm outputs, and Temperature Controller error alarm outputs. G79-□□□ cable should be used for connecting OMRON I/O Relay Terminals (G7TC-OC16, G7TC-OC08, and G7VC-OC16). By connecting to an XW2B-20G4 or XW2B-20G5 Terminal Block, signals can be obtained directly.

CN502

Is used for communications. For this connector, an OMRON XM3B-0922 or equivalent should be used.

Switches

The power must be turned off before changing any switch settings. Changes made while the power is on will be invalid.

SW303

Is used to set the unit number that is used to identify the E5ZD during communications.

SW501

Is used to set the baud rate for communications.

SW502

Is used to set the type of sensor being used (i.e., either K or J for thermocouples, and either Pt100 or JPt100 for platinum resistance thermometers) and the control temperature range.

SW503

Is used to set the functions that determine E5ZD operation. These include selection of either normal operation or the communications test, communications or inputs designating the current memory banks, the use of Celsius or Fahrenheit, and operation or non-operation when power is turned on.

SW507 and SW508

Are terminator switches for activating the termination resistance when RS-422 or RS-485 communications are used. The switch must be turned on at the terminator. (i.e. the E5ZD Controller located farthest from the host computer).

Others**Card Pullers**

Are used to remove the E5ZD when it is mounted to a rack. It is not necessary when the E5ZD is screwed in place.

Mounting Screws

Are eight mounting holes provided for mounting the E5ZD. In order to maximize resistance to vibration and shock, use all of the holes.

2-3-4 Connector Allocations and Wiring

Allocations and wiring guidelines for connectors and Terminal Blocks are provided on the following pages.

CN301 Terminal Assignments

The following table shows the terminal assignments for CN301. The DC+ and DC- terminals are internally connected. Do not connect anything to the unused terminals.

Terminal	Row a (bottom)		Row c (top)	
	Name	Function	Name	Function
1	DC+	24-VDC power supply	DC+	24-VDC power supply
2	DC+	24-VDC power supply	DC+	24-VDC power supply
3	Not used		Not used	
4	DC-	0-VDC power supply	DC-	0-VDC power supply
5	DC-	0-VDC power supply	DC-	0-VDC power supply
6 to 22	Not used		Not used	
23	SG	RS-422: SG	SG	RS-422: SG
24	SDA(-)	RS-422: SDA, RS-485: terminal A	SDA(-)	RS-422: SDA, RS-485: terminal A
25	SDB(+)	RS-422: SDB, RS-485: terminal B	SDB(+)	RS-422: SDB, RS-485: terminal B
26	RDA	RS-422: RDA	RDA	RS-422: RDA
27	RDB	RS-422: RDB	RDB	RS-422: RDB
28 to 32	Not used		Not used	

CN324 and CN325 Terminal Assignments

CN324 and CN325 connect sensor inputs. For thermocouple inputs, only thermocouple input Terminal Blocks (E54-TR011) can be used.

Terminal	E5ZD-8H <input type="checkbox"/> KMJ-E				E5ZD-8H <input type="checkbox"/> PM-E			
	CN324		CN325		CN324		CN325	
	Row a (top)	Row b (bottom)	Row a (top)	Row b (bottom)	Row a (top)	Row b (bottom)	Row a (top)	Row b (bottom)
1								
2	Point 3 (-)		Point 7 (-)					
3		Point 3 (+)		Point 7 (+)	Point 1 (B)	Point 3 (B)	Point 5 (B)	Point 7 (B)
4					Point 1 (B)	Point 3 (B)	Point 5 (B)	Point 7 (B)
5	Point 1 (+)	Point 1 (-)	Point 5 (+)	Point 5 (-)	Point 1 (A)	Point 3 (A)	Point 5 (A)	Point 7 (A)
6								
7	Point 2 (-)		Point 6 (-)					
8		Point 2 (+)		Point 6 (+)	Point 0 (B)	Point 2 (B)	Point 4 (B)	Point 6 (B)
9					Point 0 (B)	Point 2 (B)	Point 4 (B)	Point 6 (B)
10	Point 0 (+)	Point 0 (-)	Point 4 (+)	Point 4 (-)	Point 0 (A)	Point 2 (A)	Point 4 (A)	Point 6 (A)
11								
12								

CN326 Terminal Assignments

CN3246 has terminals for connecting CT sensors and for inputting memory bank designations. CT terminals are not polarity sensitive and may be connected as desired to the CT input terminals. The memory bank designation selects memory banks 0 to 7. This terminal becomes active when shorted to the signal input common.

Terminal	Row a (top)		Row c (bottom)	
	Name	Function	Name	Function
1	ING	Memory bank designation input common	BANK1	2 ¹ memory bank designation
2	BANK2	2 ² memory bank designation	BANK0	2 ⁰ memory bank designation
3	CT7	CT input for point 7	CT3	CT input for point 3
4	CT7	CT input for point 7	CT3	CT input for point 3
5	CT6	CT input for point 6	CT2	CT input for point 2
6	CT6	CT input for point 6	CT2	CT input for point 2
7	CT5	CT input for point 5	CT1	CT input for point 1
8	CT5	CT input for point 5	CT1	CT input for point 1
9	CT4	CT input for point 4	CT0	CT input for point 0
10	CT4	CT input for point 4	CT0	CT input for point 0
11				
12				

CN327 Terminal Assignments

CN327 has output terminals for control outputs, Alarm 1 and Alarm 2 outputs, HB alarm outputs, HS alarm outputs and Temperature Controller error alarm outputs. These are all open collector outputs. Be careful when wiring the alarm outputs, because there is no protection against excessive current.

The HB alarm output goes ON when the detected current falls below the set heater current. The HS alarm output goes ON when the control output is OFF and current to the CT is 0.5 A or more. The Temperature Controller error output goes ON when an abnormality is detected within the E5ZD.

The two COM terminals are minus common terminals for open collector output, and are connected inside of the the E5ZD-8H□□M-E.

Terminal	Row a (top)		Row c (bottom)	
	Name	Function	Name	Function
1	CTRL0	Control output 0B for point 0	ALM1	Alarm output 1
2	CTRL1	Control output 1B for point 1	ALM2	Alarm output 2
3	CTRL2	Control output 2B for point 2	HBALM	HB alarm output
4	CTRL3	Control output 3B for point 3	HSALM	HS alarm output
5	CTRL4	Control output 4B for point 4	TCTRBL	Error output
6	CTRL5	Control output 5B for point 5		
7	CTRL6	Control output 6B for point 6		
8	CTRL7	Control output 7B for point 7		
9	COM	Output common	COM	Output common
10				
11				
12				

Power Supply Terminals

Power is supplied to the 8-point controllers through the DC+ and DC– terminals. Connect the DC+ terminals to 24 VDC; the DC– terminals to 0 VDC. The rated voltage (21.6 to 26.4 V) must be supplied to the DIN connector on the E5ZD; these are not switching power-supply terminals.

To ensure activation of the power supply, it is necessary that at least twice the rated current capacity be available when power is turned on.

Memory Bank Terminals

The BANK0, BANK1, BANK2, and three ING terminals can be used to select the memory bank to be used for temperature control. Refer to *Section 3-3 Memory Banks* for operational details. The BANK0, BANK1, and BANK2 terminals are activated by connecting each to a ING terminal. The terminals can be connected either through contacts, e.g., relays, or through transistors or other no-contact devices. The memory banks designated by the various open-closed combinations of these terminals are shown in the following table.

Memory bank	Bank 0	Bank 1	Bank 2	Bank 3	Bank 4	Bank 5	Bank 6	Bank 7
BANK0-ING	Open	Closed	Open	Closed	Open	Closed	Open	Closed
BANK1-ING	Open	Open	Closed	Closed	Open	Open	Closed	Closed
BANK2-ING	Open	Open	Open	Open	Closed	Closed	Closed	Closed

Signal Input Method

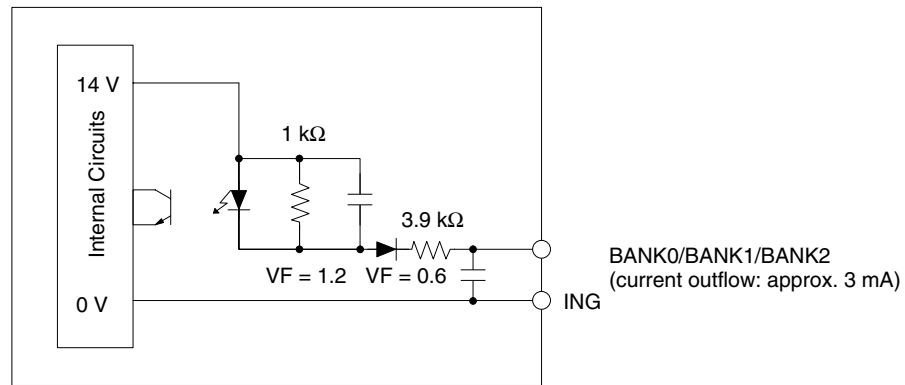

Contact Inputs

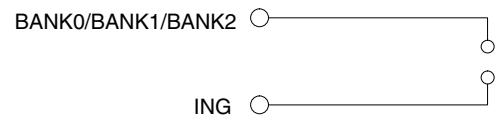

ON: Connection resistance of 1 kΩ max.
 OFF: Open resistance of 100 kΩ min.

No-contact Inputs (Open Collector)

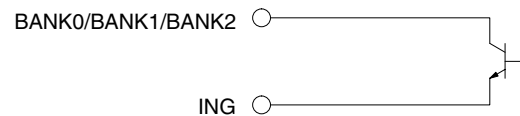

ON: Residual voltage of 2 V max.
 OFF: Leakage current of 1 mA max.

Control Outputs

The control outputs can be wired for independent use as voltage outputs or as open-collector outputs. In either case, a diode must be included in the output circuit to protect the Unit's internal circuits.

Circuit Configuration

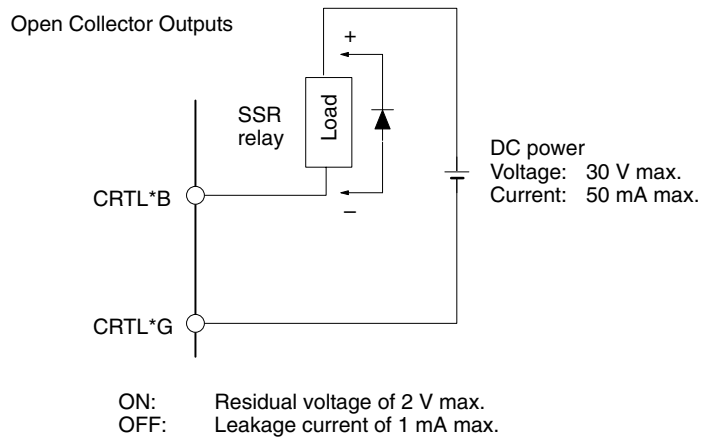
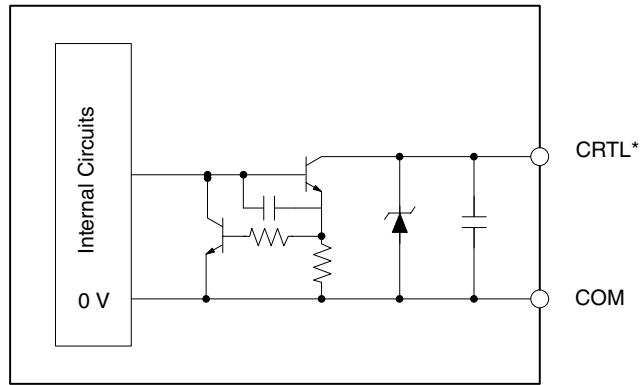

All alarm and error outputs are open-collector outputs. The connection methods of these outputs are the same as those of the open-collector control outputs.

Caution Alarm and error outputs are not protected from excessive current flow and voltage (exceeding 50 mA at 30 VDC); be sure to wire them correctly to protect internal circuits from damage.

CT Inputs

CT terminals are not polarity sensitive and may be connected as desired to the CT input terminals.

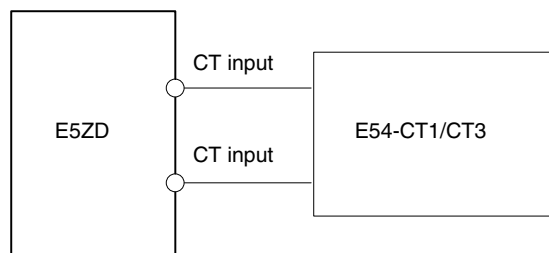

2-3-5 Terminal Blocks for Sensors

This section covers the arrangement and wiring of terminals on the sensor Terminal Blocks. The Terminal Block used for thermocouple inputs differs from the one used for platinum resistance thermometer inputs. Secure the lead wires so that they do not make contact with the product. If they touch the product or other items they may cause damage.

E5ZD-8H□□KJM-E

E54-TR011 Terminal Block can be used for E5ZD-8H□□KJM-E thermocouple inputs.

E54-TR011 Terminal Arrangement

The point numbers outside of the parentheses are for connection to CN324, and the point numbers inside of the parentheses are for connection to CN325.

Do not use terminals 5 through 10 and 15 through 20. Using these terminals may result in internal damage, so leave them open.

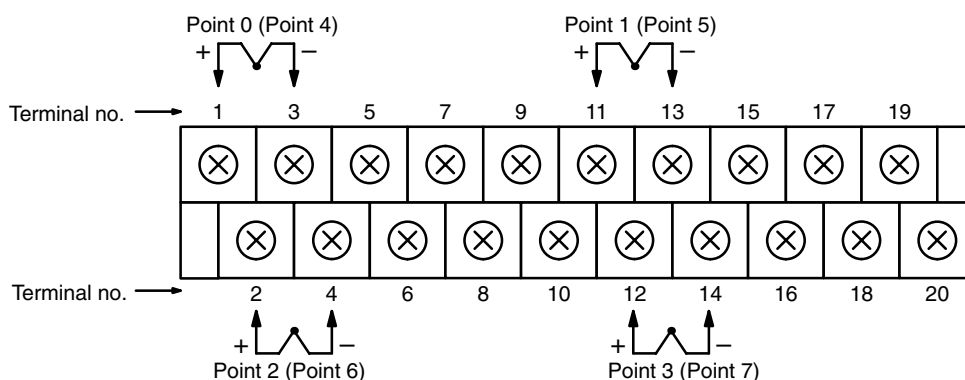

E5ZD-8H□PM-E

XW2B-20G4, or XW2B-20G5 Terminal Blocks can be used for E5ZD-8H□PM-E platinum resistance thermometer inputs.

XW2B-20G4 or XW2B-20G5 Terminal Arrangement

The diagram shows the terminal arrangement for a XW2B-20G5, but the numbers are the same for a XW2B-20G4. The point numbers outside of the parentheses are for connection to CN324, and the point numbers inside of the parentheses are for connection to CN325.

Do not use terminals 7 through 10 and 17 through 20. Using these terminals may result in internal damage, so leave them open.

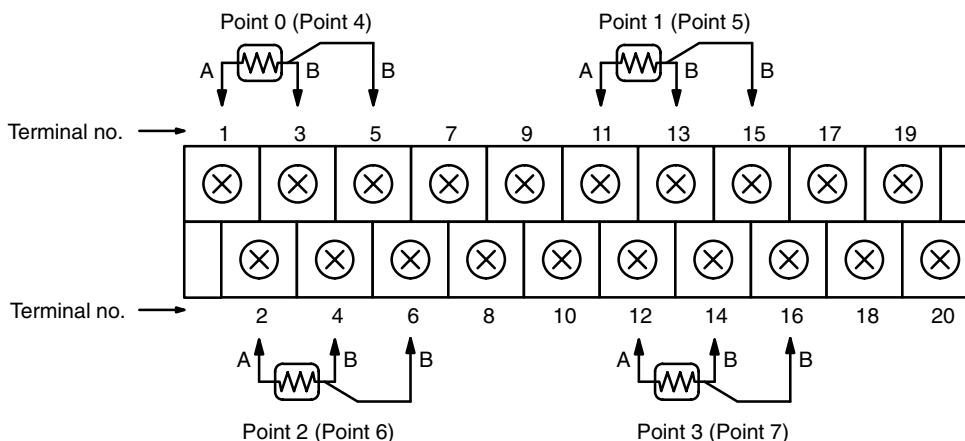

2-3-6 Terminal Blocks for Control and Alarm Outputs

This section covers the arrangement and wiring of terminals on the Terminal Blocks for control and alarm outputs. For obtaining signals from control outputs or alarm outputs, the signals shown below can be output by connecting through-type Terminal Blocks (XW2B-20G4 or XW2B-20G5). Secure the lead wires so that they do not make contact with the product. If they touch the product or other items they may cause damage.

XW2B-20G4 or XW2B-20G5 Terminal Arrangement

The diagram shows the terminal arrangement for a XW2B-20G5, but the numbers are the same for a XW2B-20G4.

Do not use terminals 1, 2, 5, 7, and 9. Using these terminals may result in internal damage, so leave them open.

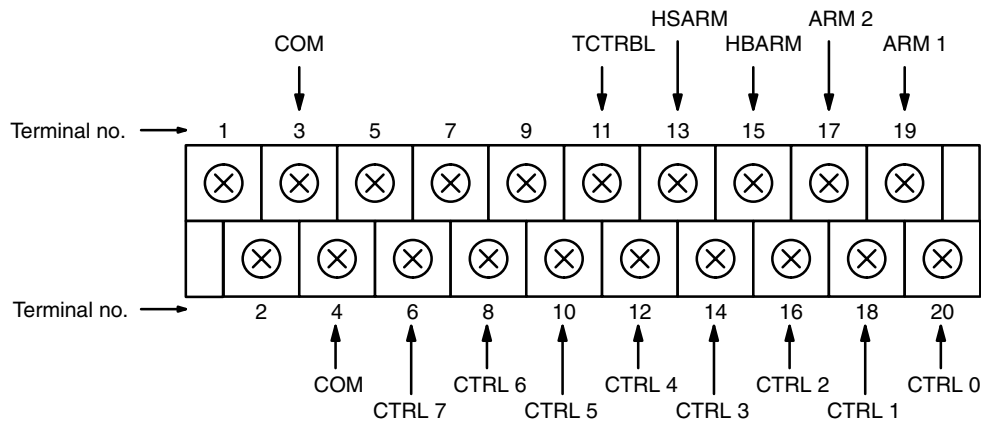

Relay Numbers for I/O Terminals

G7TC-OC16, G7TC-OC08, and G7VC-OC16 I/O Terminals do not have an internal power supply. Connect the relay drive power supply to the plus and minus terminals. Even if relays for 24 VDC are used, noise resistance can be strengthened by providing separate power supplies to the E5ZD and the I/O Relay Terminal instead of providing them with a common power supply. In addition, provide a power supply at the load (contacts) that corresponds to the load. Outputs 8 to 12 cannot be received when a G7TC-OC08 is used.

Terminal	Name	Function
0	CTRL0	Control output for point 0
1	CTRL1	Control output for point 1
2	CTRL2	Control output for point 2
3	CTRL3	Control output for point 3
4	CTRL4	Control output for point 4
5	CTRL5	Control output for point 5
6	CTRL6	Control output for point 6
7	CTRL7	Control output for point 7
8	ALM1	Alarm 1 output
9	ALM2	Alarm 2 output
10	HBALM	HB alarm output
11	HSALM	HS alarm output
12	TCTRBL	Error output
13 to 16	Not used	

2-3-7 Terminal Blocks for CT and Memory Bank Designation Inputs

This section covers the arrangement and wiring of terminals on the Terminal Blocks for CT and memory bank designation inputs. The input signals will be as shown below for through-type Terminal Blocks (XW2B-20G4 or XW2B-20G5). Secure the lead wires so that they do not make contact with the product. If they touch the product or other items they may cause damage.

XW2B-20G4 or XW2B-20G5 Terminal Arrangement

The diagram shows the terminal arrangement for a XW2B-20G5, but the numbers are the same for a XW2B-20G4. Leave unused terminals open.

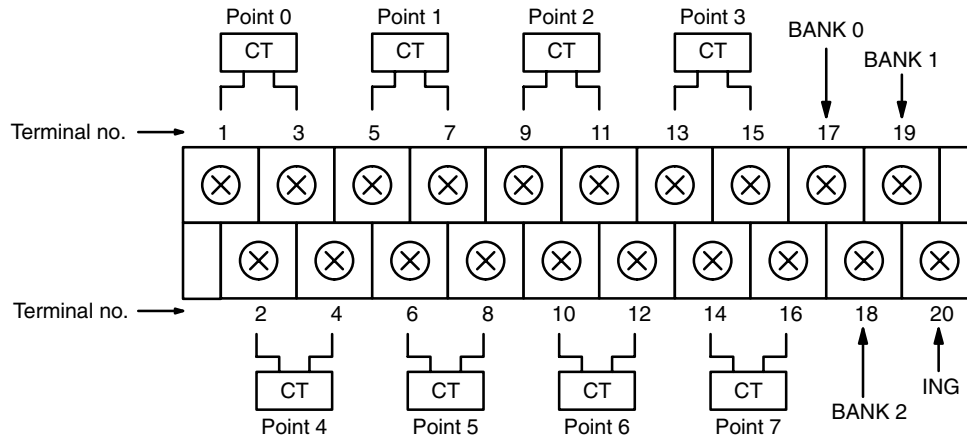

2-3-8 Sensor Input Precautions

This section explains the precautions to be observed when using sensor inputs.

Display Precision

The display precision for the E5ZD-8H□□M-E can be assured when G79-200C cable is used. Due to the influence of the cable’s lead wire resistance, however, errors may occur if the cable length is 2 meters or more.

For the E5ZD-8H□KJM-E, the influence of the lead wire resistance on the display is 1% FS/100 Ω max. For the E5ZD-8H□PM-E, it is 1% FS/5Ω max (per line). The influence of lead wire resistance on the E5ZD-8H□PM-E is approximately 0.23 Ω for G79-100C cable, 0.43 Ω for G79-200C cable, and 1.01 Ω for G79-500C cable. When G79-500C is used instead of G79-200C, the difference can be found by means of the following equation:

$$(1.01 - 0.43) \times 1/5 = 0.116\% \text{ FS}$$

The display precision for the E5ZD-8H□PM-E is calculated within ±0.5% FS ± one digit maximum, so the result can be obtained by means of the following equation:

$$0.5 + 0.116 = 0.616\% \text{ FS}$$

The command error will thus be ± 0.616% FS ± one digit maximum. Command errors are more likely to occur when long cable is used, due to the influence of noise. Therefore, try to reduce noise as much as possible, and ground with shields at both ends.

Sensor Expansion

To avoid errors in temperature measurement, when expanding the thermocouples be sure to use compensating lead wire which conforms to the thermocouples being used. In addition, do not place any metal other than the thermocouples and the compensating lead wire between the sensors and the Terminal Block.

Dealing with Unused Points When there are unused input terminals, do not leave them open, either for thermocouple inputs or platinum resistance thermometer inputs. Leaving them open will cause a malfunction. Instead, deal with them as follows:

Thermocouple inputs Short-circuit the plus and minus terminals for the same point. The measured temperature then becomes the temperature for the Terminal Block.

Platinum Resistance Thermometer Inputs Connect a resistance of 100 Ω to 177 Ω (within the temperature range set by the switches) between the A and B terminals of the same point. Short-circuit between the B terminals. The measured temperature will then correspond to the resistance.

2-3-9 Communications Interfaces

E5ZD-8H□□M-E specifications for the communications interfaces are the same as those for 4- and 6-point controllers. Return to *2-1-4 Communications Interfaces* for the specifications.

2-3-10 Switch Settings

For the following switch settings to be effective, they must be made with the power to the E5ZD turned OFF, i.e., the switch status is read only when the power is turned ON.

Unit Number: SW303

Each E5ZD-8H□□M-E Temperature Controller is assigned a unit number to enable easy identification of the Units during communications with the host computer. The unit number (between 0 and F) is set using SW303. When multiple E5ZDs are connected to the same host computer, the same unit number must not be set for more than one E5ZD. The unit number is set to 0 at the factory.

Baud Rate: SW501

The baud rate determines the transmission speed for communications with the host computer. The host computer must be set to the same baud rate as the E5ZD for communications to be possible. Set SW501 to between 0 and 6 to set the baud rate according to the following table. Do not set SW501 to between 7 and 9.

SW3 setting	0	1	2	3	4	5	6	7 to 9
Baud rate	150	300	600	1,200	2,400	4,800	9,600	Not allowed.

Sensor Specifications: SW502

Set these pins to establish the type of sensor and the temperature range to be used. Pins 4 to 9 are not used, so leave them OFF. All pins are set to 0 at the factory, so the K setting will be 0°C to 400°C for thermocouple specifications, and the Pt100 setting will be -100.0°C to 200.0°C for platinum resistance thermometer specifications. The Celsius/Fahrenheit setting is made on SW503.

E5ZD-8H□KJM-E

Pin	0	1	2	3
Sensor type	K		J	
°C	0° to 400°C	0° to 600°C	0° to 400°C	0° to 600°C
°F	32° to 752°F	32° to 1112°F	32° to 752°F	32° to 1112°F

E5ZD-8H□PM-E

Pin	0	1	2	3
Sensor type	Pt100		JPt100	
°C	-100.0° to 200.0°C	0° to 500°C	-100.0° to 200.0°C	0° to 500°C
°F	-148.0° to 392.0°F	32° to 932°F	-148.0° to 392.0°F	32° to 932°F

Function Switch: SW503

SW503 determines some of the basic operating parameters of the E5ZD, as shown in the following table. These settings are described below. Switch appearance and pin number are the same as SW502, shown above. All pins are set to OFF at the factory.



Pin	Function	ON	OFF
1	Operation mode	Test	Normal
2	Memory bank designation	Inputs	Communications
3	Unit of measure	Fahrenheit	Celsius
4	Initial status	Operating	Non-operating

Pin 1

Pin 1 determines whether the normal operation mode or the communications test mode (the mode in which the loop-back test is executed) is to be used. If pin 1 is set to ON and then power is applied to the E5ZD, the communications test mode will be used and the following character string will be sent continuously until the power is cut. Reception should be confirmed at the host computer. A loop-back test will be conducted simultaneously to see whether the E5ZD can receive the transmitted data back again. If it cannot receive the data back just as it was transmitted, a Temperature Controller alarm output will turn ON.

E5ZD_Copyright_1991_OMRON_Corporation (carriage return)

Pin 2

Pin 2 determines whether the current memory bank is to be set according to input status or via communications from the host computer. If pin 2 is set to ON before power is turned ON, the status of the BANK0, BANK1, BANK2, and ING terminals will determine the current memory bank. If pin 2 is OFF, the current memory bank will be determined according to commands sent from the host computer.

Pin 3

Pin 3 determines whether Fahrenheit or Celsius is to be used. (Fahrenheit and Celsius can be manually converted via this equation: $^{\circ}\text{F} = 1.8 \times ^{\circ}\text{C} + 32$.)

Pin 4

Pin 4 determines E5ZD operation in response to power interruptions during control operation. If pin 4 is set to ON, operation will continue immediately after power is restored following a power interruption. If pin 4 is set to OFF, operation will not automatically restart following power interruptions.

2-3-11 Indicators

The indicators show the I/O status of the 8-point controllers. Their positions and specific meanings are provided below.

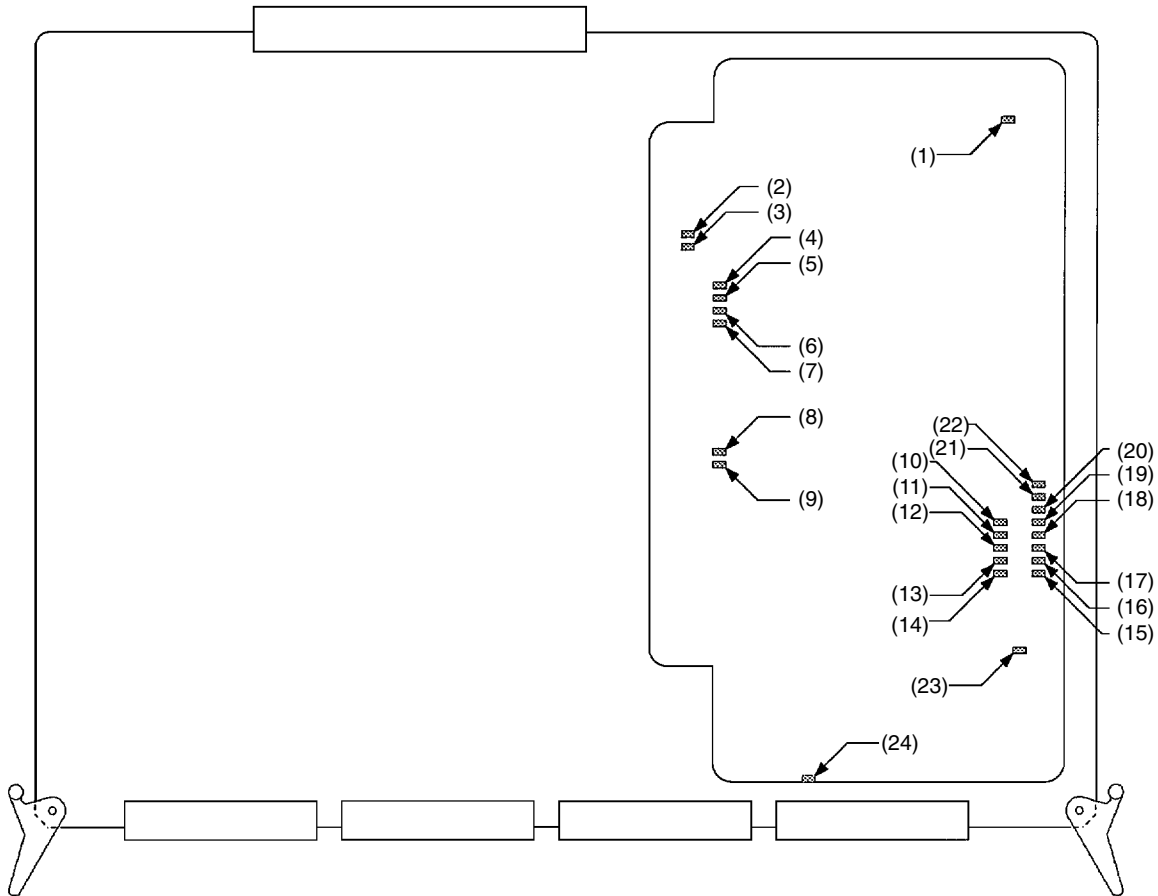

Meanings

No.	Function	Indicator lit.	Indicator not lit.
1	Reset Monitor	CPU resetting. (Note 1)	CPU operating.
2	Operation monitor 1	Monitors 1 and 2 both lit: Memory error. Monitor 1 not lit, monitor 2 lit: Communications error. (Note 2)	
3	Operation monitor 2	Monitor 1 lit, monitor 2 not lit: Point exists during AT. (Note 3) Monitors 1 and 2 both not lit: None of the above.	
4	Memory bank 0	Memory bank setting 2 ⁰ input.	Memory bank setting 2 ⁰ open.
5	Memory bank 1	Memory bank setting 2 ¹ input.	Memory bank setting 2 ¹ open.
6	Memory bank 2	Memory bank setting 2 ² input.	Memory bank setting 2 ² open.
7	Not used		
8	Reception monitor	E5ZD receiving.	E5ZD not receiving.
9	Transmission monitor	E5ZD transmitting.	E5ZD not transmitting.
10	Temperature Controller alarm output	Output ON	Output OFF
11	HS alarm output	Output ON	Output OFF
12	HB alarm output	Output ON	Output OFF
13	Alarm 2 output	Output ON	Output OFF
14	Alarm 1 output	Output ON	Output OFF
15	Point 0 control output	Output ON	Output OFF
16	Point 1 control output	Output ON	Output OFF
17	Point 2 control output	Output ON	Output OFF
18	Point 3 control output	Output ON	Output OFF
19	Point 4 control output	Output ON	Output OFF
20	Point 5 control output	Output ON	Output OFF
21	Point 6 control output	Output ON	Output OFF
22	Point 7 control output	Output ON	Output OFF
23	Power supply monitor	Power supply ON	Power supply OFF

- Note**
1. During E5ZD-8H□□M-E CPU resetting, the E5ZD will not operate and cannot communicate. The reset indicator will light for approximately 1 second after the power is applied or after a malfunction due to a cause such as noise.
 2. This type of error would be a framing error, a parity error, or an overrun error.
 3. AT: Autotuning

SECTION 3

Basic Operation

This section describes the basic operational flow of the E5ZD, including communications, memory bank operation, parameter backup to nonvolatile memory, HB and HS alarm output operation, and fuzzy-logic control. The commands used to control the E5ZD from a host computer are detailed in the next section.

3-1	Overview	52
3-2	Communications	52
	3-2-1 Communications Procedure	52
	3-2-2 Block Format	53
	3-2-3 Communications Errors	53
3-3	Memory Banks	54
	3-3-1 Memory Bank Structure	55
	3-3-2 Memory Bank Designations	55
3-4	Parameter Backup	56
3-5	HB and HS Alarms	58
	3-5-1 Theory of Operation	58
	3-5-2 Alarm Output Operation	58
	3-5-3 Precautions	58
	3-5-4 Application Example	59
3-6	Fuzzy Control	60
	3-6-1 Control Configuration	60
	3-6-2 Operating Principles	60
	3-6-3 Application	61
	3-6-4 Fuzzy Parameters, Autotuning, PID Constants	61
3-7	Features	62
	3-7-1 Fuzzy Parameters	62
	3-7-2 Affects of Fuzzy Parameters	62
3-8	Adjusting Fuzzy Parameters	64

3-1 Overview

Basic operating parameters are designated via switches on the board as described in Section 2. Other parameters are then designated via communications from the host computer. These parameters are input in groups which are stored in the memory banks, and can be changed, as a set, by designating a new memory bank.

Once all of the required operating parameters have been input, control outputs and alarm outputs are initiated according to these parameters and their relationship to the temperatures received at the temperature inputs.

Alarms include general error alarms to indicate errors in E5ZD operation, as well as HB and HS alarms, which can be generated by using a Current Transformer for the heating device.

3-2 Communications

Communications is the most important aspect of E5ZD operation. Communications can be used for everything, from setting and reading parameters to centralized data management. The basic communications procedure and protocol are described here. The actual commands used in communications are described in *Section 4 Command Set*.

3-2-1 Communications Procedure

All communications are initiated by the host computer by sending an command block to the E5ZD. The E5ZD then sends a response block back to establish conversation-type communications, i.e., each time a block is transmitted, the transmission right is also transferred. The host computer must be set up to receive the responses sent by the E5ZD. If the host computer does not receive any response, the reception buffer on the host computer may overflow. When you have turned off and on the E5ZD, do not fail to initialize the reception buffer before you send a command from the host computer, otherwise smooth data reception cannot be expected.

Host computer/E5ZD communications can be illustrated as follows:

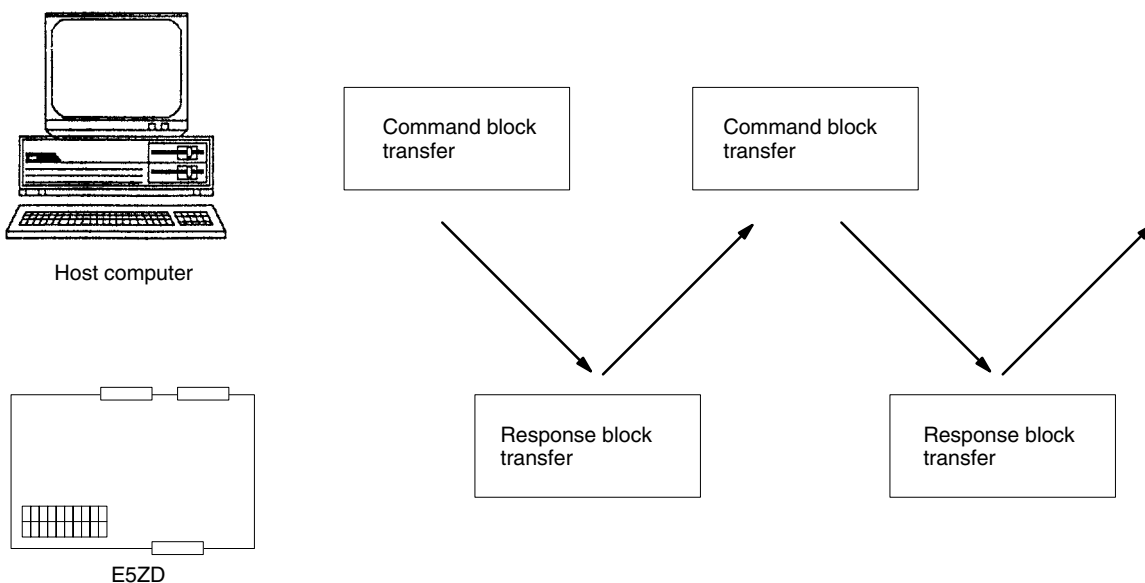

3-2-2 Block Format

The character string transmitted by the host computer is called an command block. The character string returned by the E5ZD is call a response block. Each character in the string is sent as 8-bit ASCII (see Appendix D). In this manual, characters are numerically referred to as the hexadecimal equivalent of the ASCII code. One generalized block is shown below.

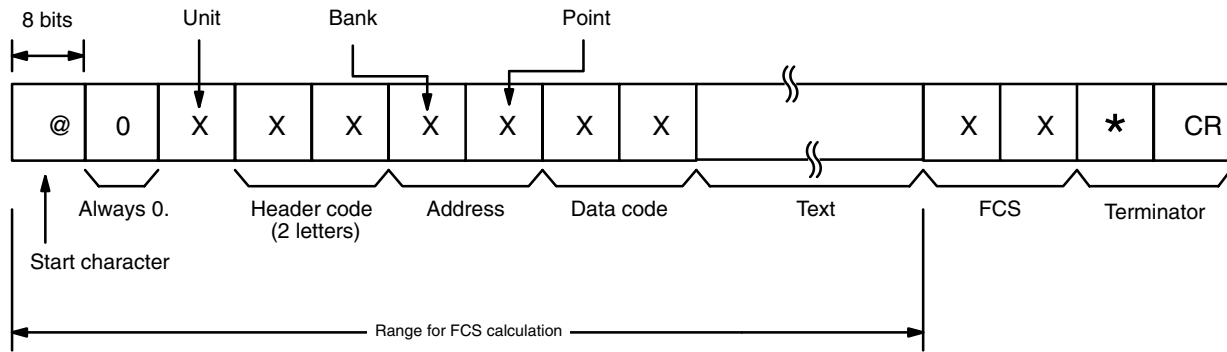

Each block begins with a start character, @ (40_{hex}), and the unit number of the E5ZD which is to receive or send the block, and ends with an FCS and a terminator. The data code identifies the type of text being transmitted. The unit number must be between 0_{hex} and F_{hex}. The terminator consists of * (2A_{hex}) and a carriage return (0D_{hex}).

3-2-3 Communications Errors

All communication errors and recovery from them must be processed at the host computer. A program must therefore be loaded into the host computer to detect errors and execute the necessary steps to recover from them.

Transmissions should be set up to be repeated about ten times in order to deal with communications errors resulting from noise. If noise-originating errors occur too frequently, either try a lower baud rate or use an optical interface.

E5ZD Checks

Error checks at the E5ZD are performed both by character and by block.

Characters are checked via vertical parity, a framing check, and an overrun check. Even parity is used with an exclusive OR performed by character. If the stop bit is found to be a 0, it will result in error generation. Finally, if the next character is received before the current character has been processed, an error is generated.

Block checks include checking the command format, numeric values, point number designations, and FCS (see the next section).

FCS Calculations

An FCS (frame check sequence) must be sent with every command block and is returned with every response block. The FCS in each response block should be checked at the host computer to confirm correct transmission.

The FCS is calculated as the exclusive OR of all characters from the start character through the final data character, as shown below. The resulting 8-bit value

is converted to ASCII for transmission as the FCS. The following example shows calculation of an FCS.

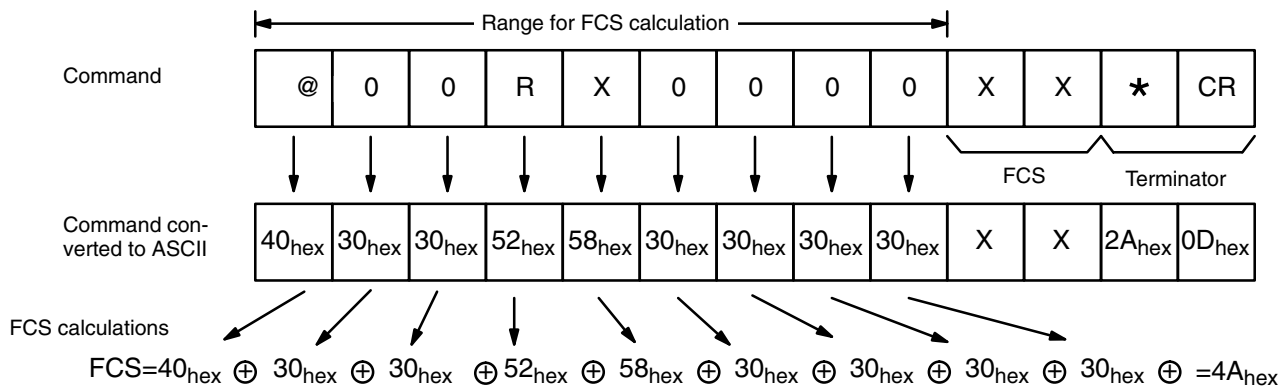

The resulting value, 4A_{hex}, is separated into the leftmost and rightmost digits, which are converted to ASCII to obtain the FCS values to be sent. The final transmitted command block would thus be as follows:

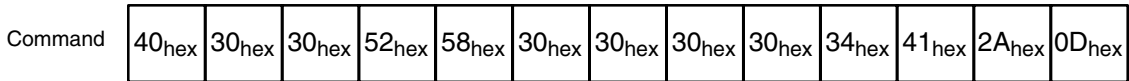

3-3 Memory Banks

The E5ZD is equipped with memory banks that allow you to change many operating parameters as sets. Some parameters are independent of the control point and determine overall E5ZD operation. Others are set by control point and are independent of the memory bank being used. The remaining parameters are contained in the memory banks.

3-3-1 Memory Bank Structure

Each control point has eight memory banks numbered from 0 through 7. When you change the current memory bank, all the settings affected by the memory bank are changed to those contained in the newly designated bank. The structure of E5ZD parameters is shown below for the E5ZD-8□□□-E or E5ZD-8H□□M-E to illustrate this. Although only the banks for two control points are shown, all control points have eight banks.

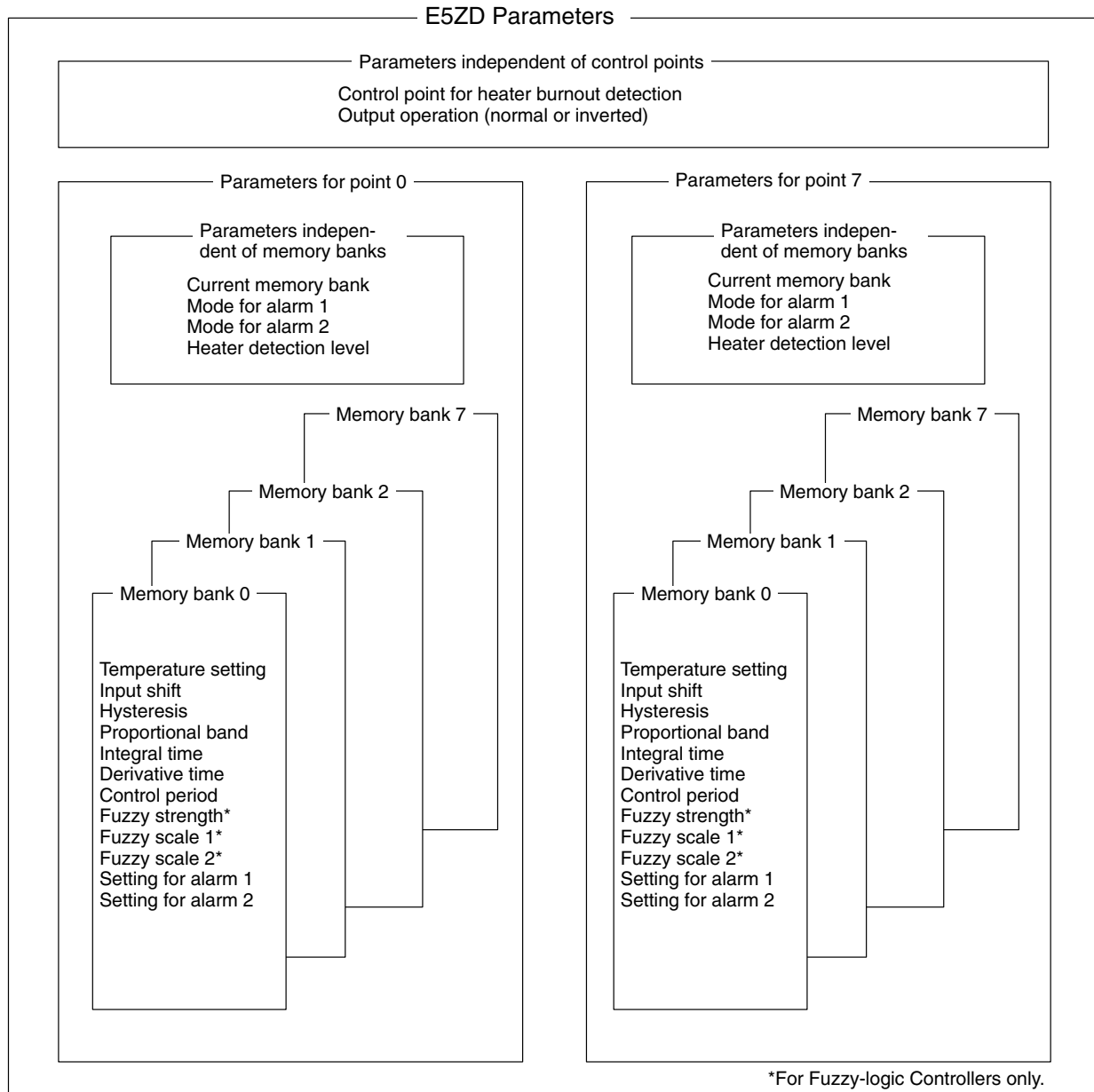

3-3-2 Memory Bank Designations

When operating the E5ZD, the desired memory bank must be designated according to input terminal status or according to commands transferred from the host computer. Although either method may be used, designation via input terminal status does not allow you to designate a different bank for each control point, as is possible from the host computer, i.e., the same memory bank number is designated for all control points. Note that this does not mean that the same

parameters must be used for each, as each control point still has its own memory settings in each memory bank.

The method of memory bank designation is set using SW5 (SW503). If input terminal status is chosen as the designation method, the status of the BANK0, BANK1, BANK2, and ING terminals on CN1 determine the current memory bank and designation by host computer command is disabled. The host computer is able to read the current memory bank regardless of the designation method.

Actual input terminal status and commands to set the current memory bank are not described here. Refer to *Section 2* for input terminal status, and *Section 4* for commands.

3-4 Parameter Backup

Inside the E5ZD, there are two types of memory used to store parameters. One is RAM, which is erased when power to the E5ZD is turned OFF; the other is non-volatile memory (EEPROM), which is used for permanent parameter storage. When parameters are set via commands from the host computer they are written into RAM. To preserve these parameter when power is interrupted or turned OFF it is necessary to use the WE command to transfer parameters to EEPROM. WE transfers all parameters for all control points at once. The movement of parameter settings is as shown below.

Caution Transfer to EEPROM requires 3.5 seconds or less for Fuzzy-logic Controllers and 2.3 seconds or less for other Controllers, delaying the response to WE. To

ensure proper transfer, power should not be turned off until this response is confirmed.

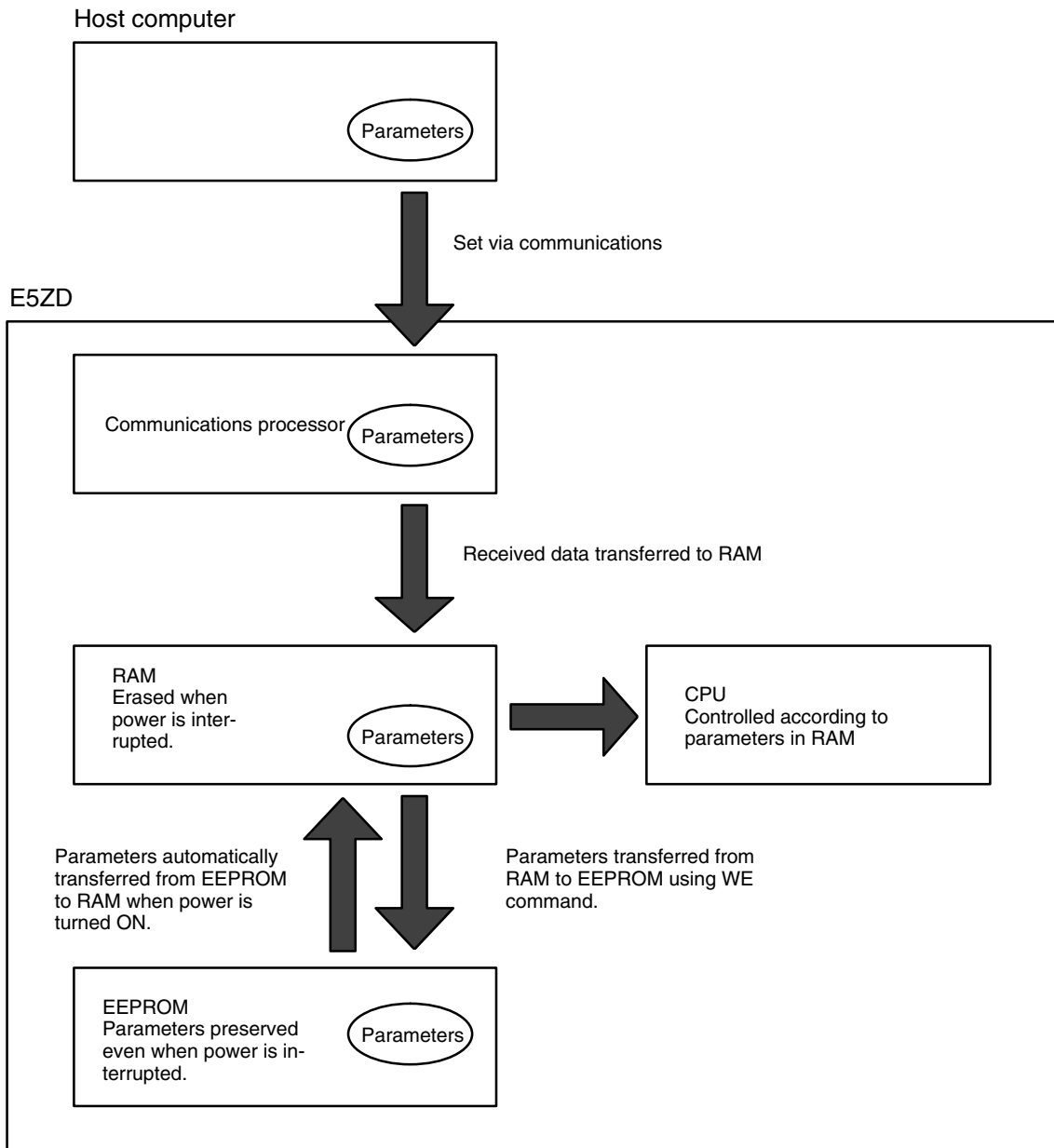

As shown above, the parameters stored in EEPROM are transferred to RAM each time the E5ZD is turned ON. If RAM parameters are changed without re-transferring the new values to EEPROM using WE, the new values will be lost and the old values will again be transferred to RAM the next time power is turned ON.

When preserving parameters in EEPROM, the response block sent after sending WE should be checked to confirm proper transfer before turning off E5ZD power. Transfer to EEPROM can be confirmed by checking the EEPROM Transfer flag in the response to the Measure Temperature Read Command (RX).

EEPROM overwrite life limited to about 10,000 times. Needless use of WE should thus be avoided. There is essentially no limit to the overwrite life of RAM.

3-5 HB and HS Alarms

Either of the E54-CT1 and E54-CT3 Current Transformers can be used with the E5ZD to detect circuit breaks or shorts (e.g., SSR failures) in the heater. Detection levels can be set independently for each control point.

3-5-1 Theory of Operation

The power supply line to the heater is passed through the hole of the Current Transformer (CT). When AC current then flows through the power supply line, an AC current will be induced in the CT and can be input to the E5ZD so that the current flow to the heater can be determined. This allows the E5ZD to detect lack of current flow when the heater is supposed to be on, resulting in the generation of an HB (heater burnout) alarm. It also allows the E5ZD to detect current flow when the heater is supposed to be off, resulting in the generation of an HS (heater short circuit) alarm, as can happen with an SSR failure. The HS alarm output goes ON when there is a current flow of 0.5 A or more on the CT when the control output of the E5ZD is OFF.

3-5-2 Alarm Output Operation

There is only one output each for the HB and HS alarms. When an error generated in any control point, the alarm output will be turned ON. Commands can then be sent from the host computer to determine which control point generated the error.

For the HB alarm output to be turned ON, the control output must be ON continuously for at least 200 ms. For the HS alarm output to be turned ON, the control output must be OFF for at least 200 ms. Either of these alarms might be delayed by up to six times the control period for 4-point models, by up to eight times the control period for 6-point models, and by up to ten times the control period for 8-point models.

3-5-3 Precautions

- Activate HB alarm operation only after turning on the power supply to the heater. If the heater is turned on after activation, the alarm output will turn ON.
- The actual current flow to the heater can vary from the rated current. Use the Heater Current Read Command (RZ) under actual operating conditions to determine appropriate detection levels.
- Allow a margin of at least 1 A between the normal heater current and the detection level. Smaller differences can result in detection instability.
- Heater burnout detection cannot be used if the heater is controlled through phased or cyclic control methods.
- The HB and HS alarms cannot be used with 3-phase heaters.
- The HS alarm output will go ON if the control output is OFF and if 0.5 A or more is flowing through the Current Transformer.

3-5-4 Application Example

The following example shows the setup required to turn ON the HB alarm output when there is a circuit break in any one of three 200-VAC, 2-kW (rated current: 10 A) heater circuits wired in parallel. This situation is as illustrated below.

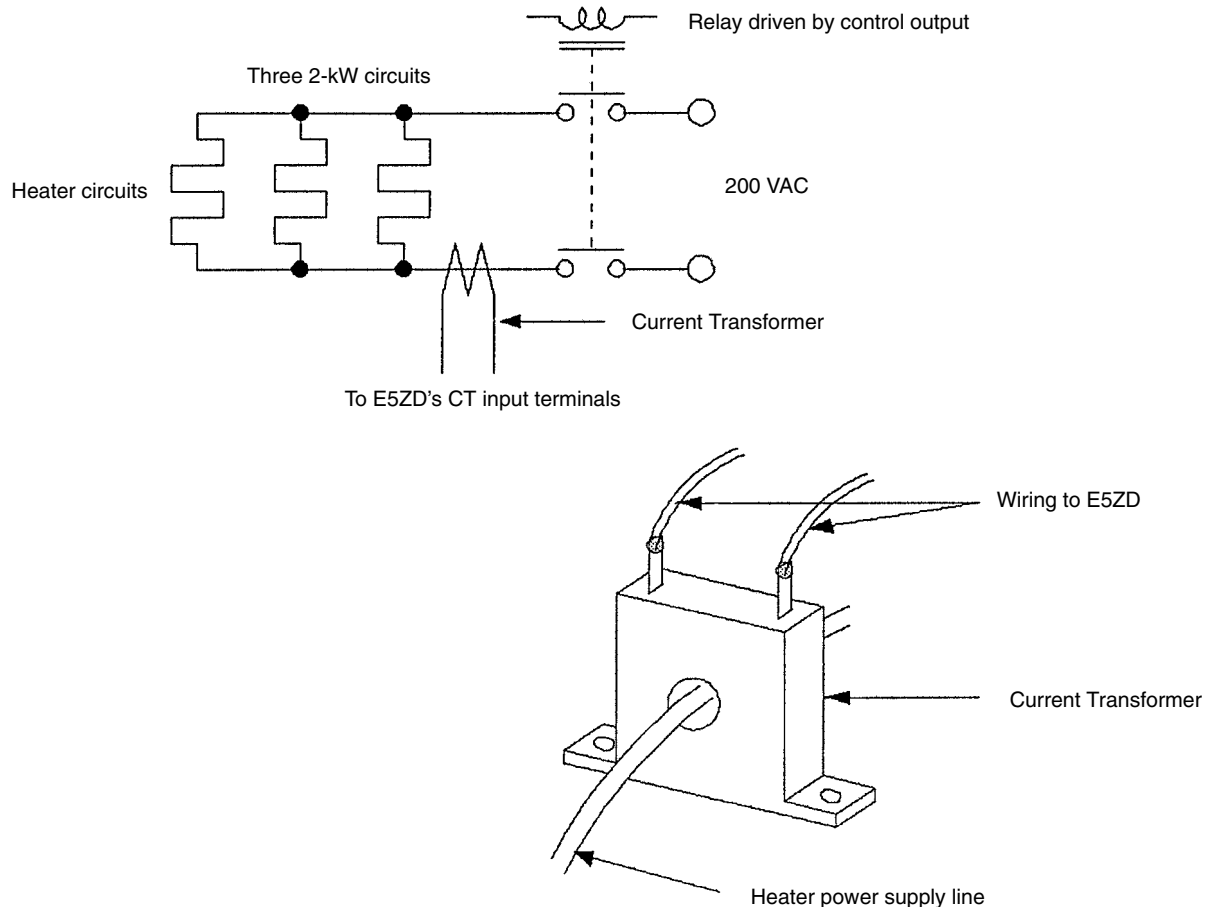

- 1, 2, 3... 1. First the heater, Current Transformer, and E5ZD are wired. (The wiring from the Current Transformer to the E5ZD is not polarity sensitive.)
2. Because the rated current is 10 A for one heater circuit, the three circuits draw 30 A. If one circuit breaks, the remaining two would draw 20 A.
3. Although here it is necessary to generate an alarm whenever the current drops below 30 A, caution is required due to the current changes that can result from changes in the power supply voltage. If we assume a maximum voltage fluctuation of 10%, the maximum current fluctuation would also be 10%. The minimum current for when all three circuits are operating and the maximum current when one of the three circuits is broken can thus be calculation as follows:
 - Minimum for 3 circuits = $30\text{ A} \times (1 - 0.1) = 27\text{ A}$
 - Maximum for 2 circuits = $20\text{ A} \times (1 + 0.1) = 22\text{ A}$
4. The detection level for heater burnout can thus be set midway between these points, at 24.5 A. (i.e., $(27\text{ A} + 22\text{ A})/2$).
5. To prevent erroneous detection, the heater circuits need to be turned on before the detection operation is activated.

3-6 Fuzzy Control

The E5ZD-8F□□□□-E incorporates hybrid control that combines fuzzy-logic control and PID with feed-forward circuitry. Hybrid control assures excellent response characteristics for external disturbance.

3-6-1 Control Configuration

The PID with feed-forward (circuitry) and fuzzy control circuitry are connected to each other in parallel. The PID circuitry is always active, while the fuzzy control circuitry is active only when there is external disturbance. This means that the control method is the same as that of other E5ZD Controllers when operation is started or when operation is stable. When there is external disturbance, however, the fuzzy control circuitry is activated to respond to the external disturbance, i.e., the E5ZD-8F□□□□-E adjusts overshooting and undershooting to ensure stable operation.

3-6-2 Operating Principles

The total output of the E5ZD-8F□□□□-E consists of the output of the fuzzy control circuitry and that of the PID with feed-forward circuitry. The fuzzy control circuitry outputs a compensation according to the temperature deviation (external disturbance) and the derivative of the deviation (i.e., the speed of the temperature change) that are input to the fuzzy control circuitry. Judging from the temperature deviation and the derivative of the deviation, the fuzzy control circuitry increases or decreases the output of the PID with feed-forward circuitry.

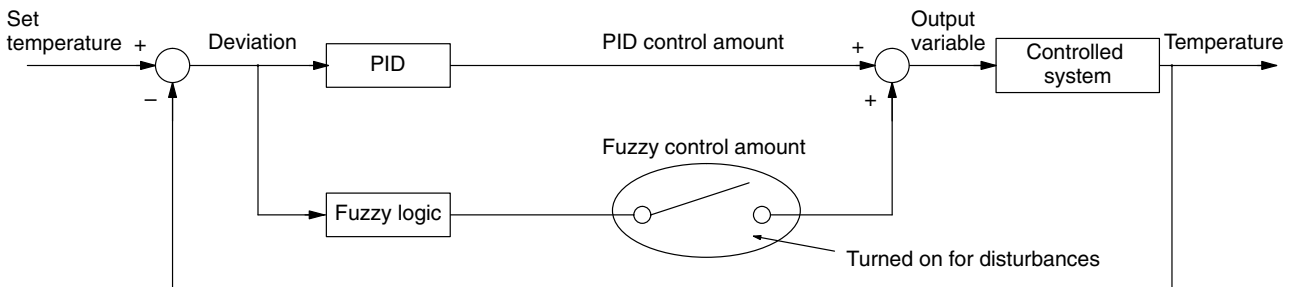

Control Section Block Diagram

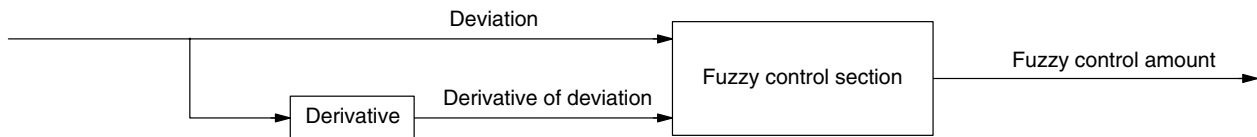

Fuzzy Inputs and Output

Fuzzy Control Output

When the temperature is higher or lower than the set temperature, the fuzzy control circuitry will produce an output to return the temperature to the set value. When the temperature approaches the set value, the fuzzy control circuitry will have no output and only PID with feed-forward circuitry will control the tempera-

ture. If the temperature approaches the set value too quickly, the fuzzy control circuitry will produce an output to prevent overshooting or undershooting.

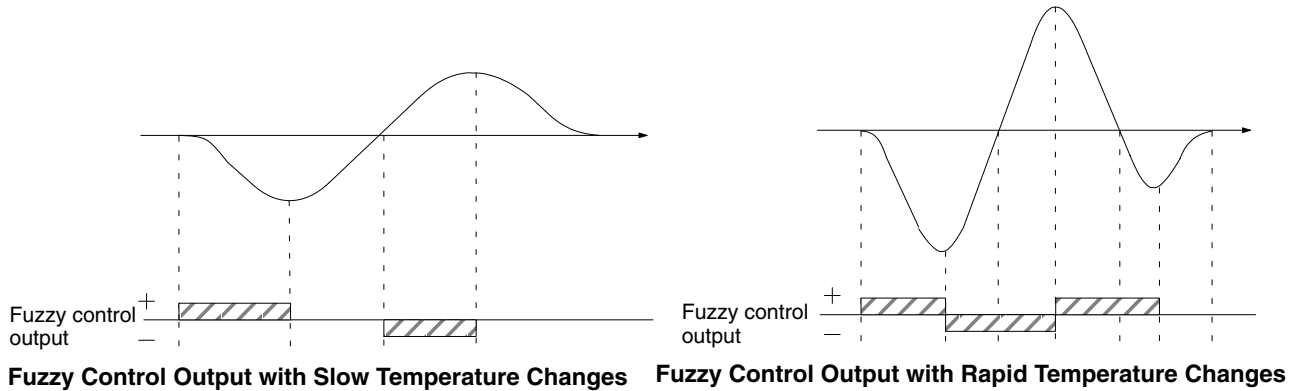

3-6-3 Application

The PID with feed-forward circuitry of the E5ZD-8F□-E is always activated, while the fuzzy control circuitry is activated only when there is external disturbance. It is thus possible to adjust the PID parameters in the same way as for any other E5ZD Controller.

To change the control waveform at startup or during stable operation, adjust the PID parameters. When the PID parameters are adjusted, the parameters of the fuzzy control circuitry will be modified automatically. To adjust the external disturbance waveform, adjust the parameters of the fuzzy control circuitry. If the parameters of the fuzzy control circuitry are adjusted, only the external disturbance waveform will change without influencing the control waveform when starting operation or during stable operation.

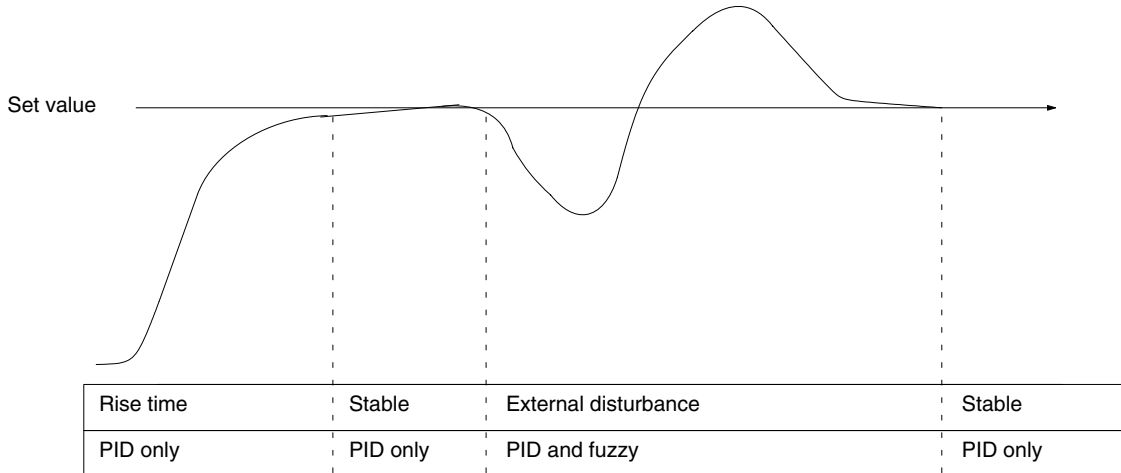

Control Waveform vs. Fuzzy Control Circuitry

3-6-4 Fuzzy Parameters, Autotuning, PID Constants

Autotuning makes it possible to automatically set the parameters of the fuzzy control circuitry just like PID parameters; the user does not need to worry about the settings of parameters during normal operation.

Autotuning automatically sets the values of fuzzy scales 1 and 2 as well as the PID parameters. The fuzzy strength, however, will not change. If the PID parameters have been manually changed, the values of fuzzy scales 1 and 2 will be automatically set according to the PID parameters that have been changed: to change the parameters of the fuzzy control circuitry manually, set the PID parameters first.

3-7 Features

3-7-1 Fuzzy Parameters

The E5ZD-8F□□□□-E has three parameters: fuzzy strength, fuzzy scale 1, and fuzzy scale 2.

The fuzzy strength, which is an output membership function scale, is used to increase or decrease the amount of fuzzy control. The larger the fuzzy strength is, the more fuzzy control will be exerted.

Fuzzy scale 1, which is an input membership function scale, determines the size interpretation of the temperature deviation. The larger the fuzzy scale 1 value is, the greater the amplitude of external disturbance is seen for the same disturbance.

Fuzzy scale 2, which is a deviation derivative input membership function scale, determines the size interpretation of the deviation derivative. The larger the fuzzy scale 2 value is, the slower the speed of external disturbance is seen for the same disturbance.

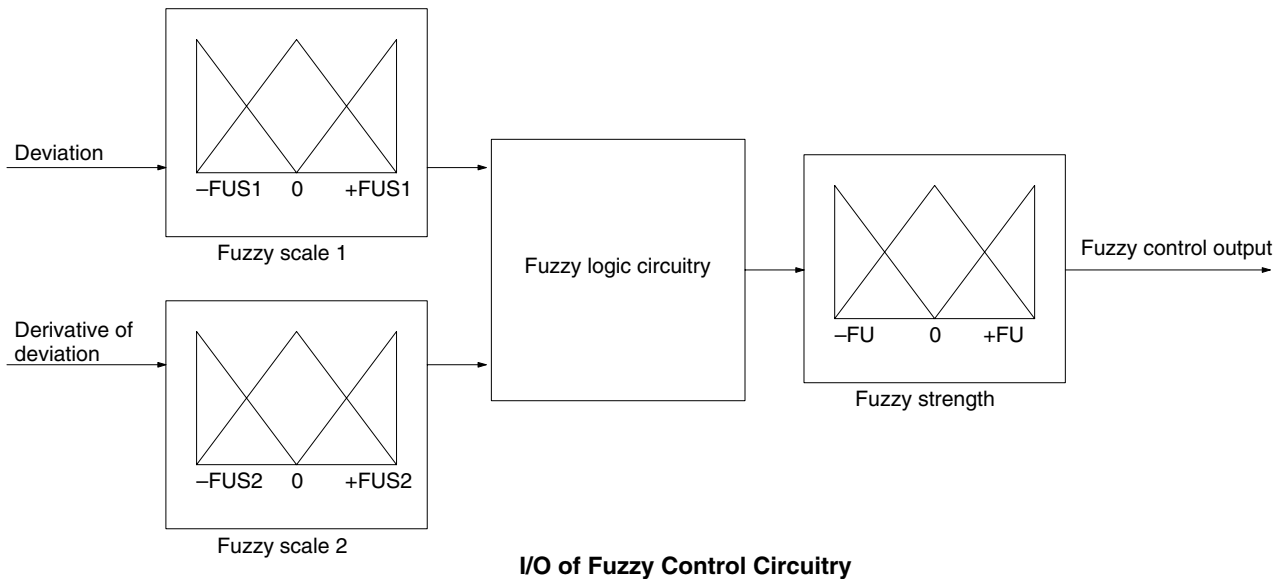

3-7-2 Affects of Fuzzy Parameters

Fuzzy Strength

Overshooting and undershooting will decrease when the fuzzy strength is increased. If the fuzzy strength value is too large, however, temperature oscillation will occur. When the fuzzy strength value is small, overshooting or undershooting will increase but temperature oscillation will decrease. When the fuzzy

strength is 0, the fuzzy control circuit will not work and only the PID with feed-forward circuitry will work.

Small ← Fuzzy strength → Large

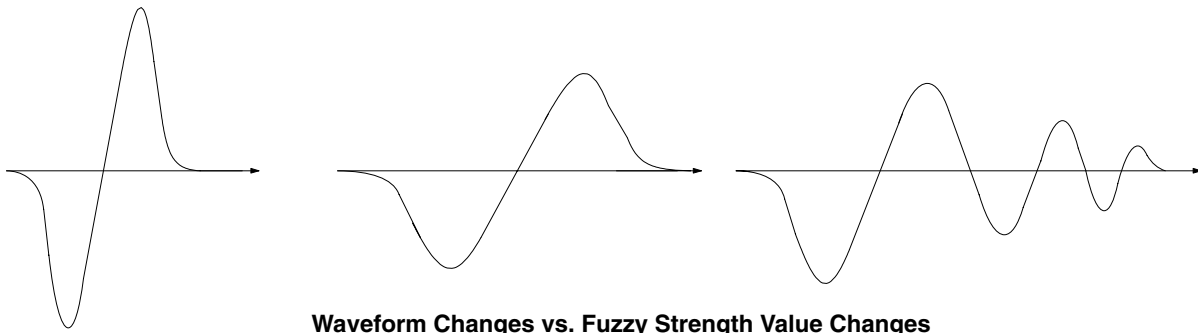

Waveform Changes vs. Fuzzy Strength Value Changes

Fuzzy Scale 1

When the value of fuzzy scale 1 is large, response will be slow, temperature oscillation will be reduced, and overshooting and undershooting will increase when the temperature is a long way from the set temperature. When the value of fuzzy scale 1 is small, response will be fast and overshooting and undershooting when greatly separated from the set temperature will decrease, but temperature oscillation will increase.

Large ← Fuzzy scale 1 → Small

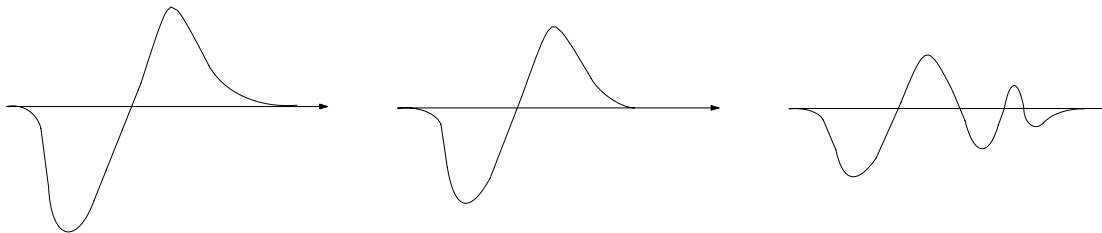

Waveform Changes vs. Fuzzy Scale 1 Value Changes

Fuzzy Scale 2

When the value of fuzzy scale 2 is large, response will be slow, temperature oscillation will be reduced, and overshooting and undershooting will increase when the temperature rapidly returns to the set temperature. When the value of fuzzy scale 2 is small, response will be fast and overshooting and undershooting when rapidly returning to the set temperature will decrease, but temperature oscillation will increase.

Large ← Fuzzy scale 2 → Small

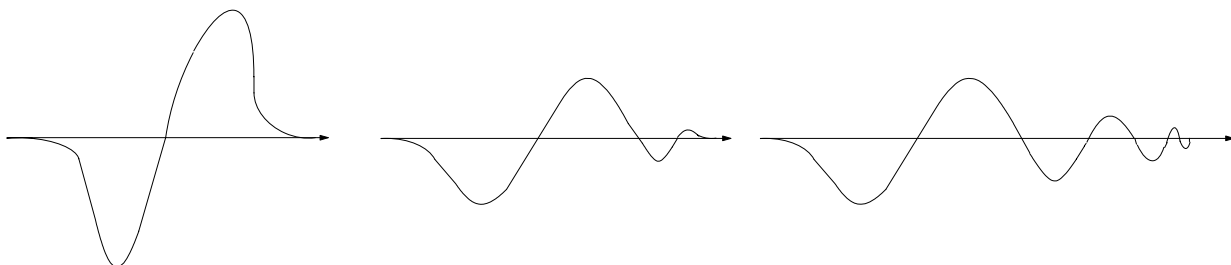

Waveform Changes vs. Fuzzy Scale 2 Value Changes

Note The values of fuzzy scales 1 and 2 will be automatically adjusted when the PID constants are autotuned or changed by communications.

3-8 Adjusting Fuzzy Parameters

When overshooting or undershooting is caused once by external disturbance, adjust the fuzzy parameters as follows:

Increase the fuzzy strength to reduce the overshooting or undershooting and make the temperature stable. If the fuzzy strength is increased too much, temperature oscillation will occur.

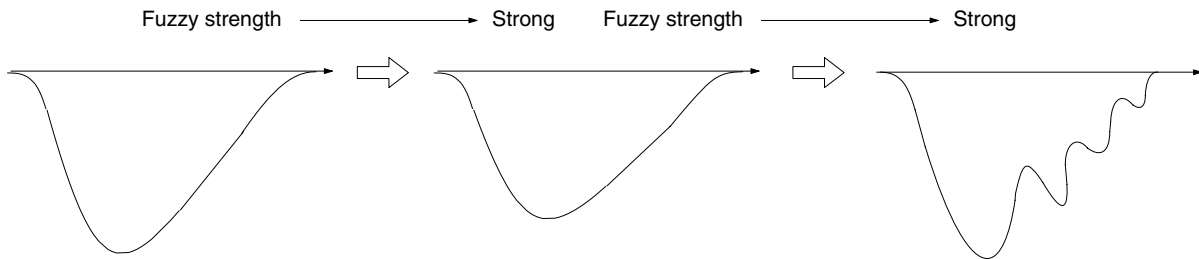

Increase the value of fuzzy scale 1 to reduce the temperature oscillation.

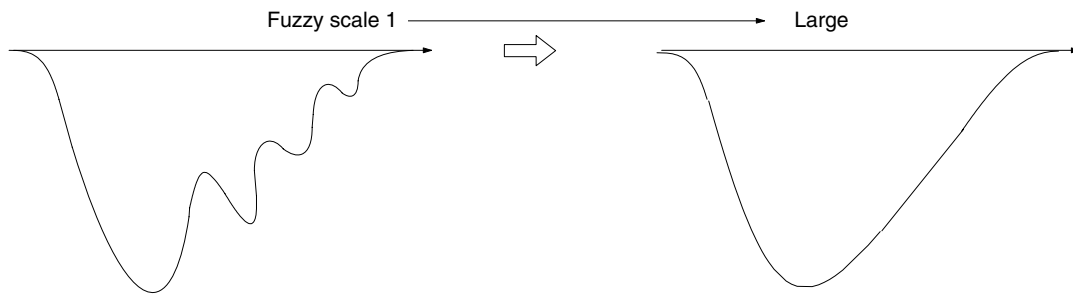

When overshooting and undershooting repeat for two cycles more due to external disturbance, adjust the fuzzy parameters as follows:

If the second overshooting or undershooting is as large as the first, increase the fuzzy strength. If the fuzzy strength is increased too much, temperature oscillation will occur.

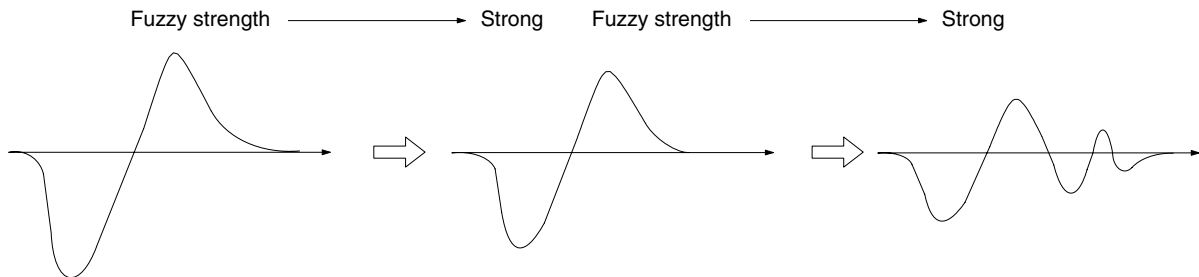

If the second overshooting or undershooting is smaller than the first, decrease the value of fuzzy scale 1.

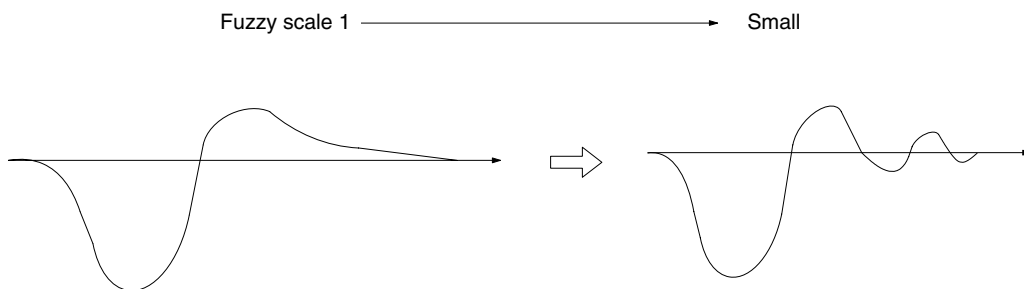

Increase the value of fuzzy scale 1 if there is temperature oscillation after the second overshooting or undershooting.

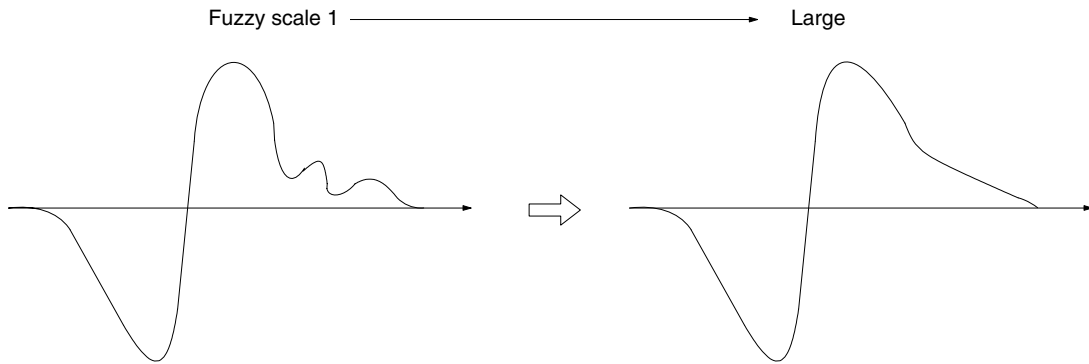

Decrease the value of fuzzy scale 2 if the temperature does not return to normal after the above operations.

Increase the value of fuzzy scale 1 if the second overshooting or undershooting is as large as the first and there is temperature oscillation.

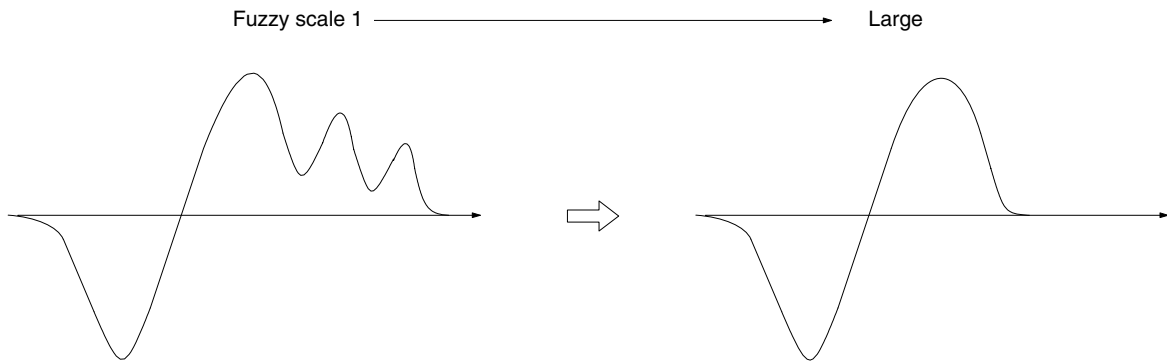

Decrease the value of fuzzy scale 2 if the temperature does not return to normal after the above operations.

SECTION 4

Commands and Responses

This section explains the commands sent from the host computer to control and monitor E5ZD operation and the responses returned by the E5ZD. These are grouped according to purpose. The first section lists the commands and the operational status under which they are valid. It also lists the end codes returned as part of E5ZD responses. These end codes are the main means of monitoring communications.

4-1	Overview	68
4-1-1	Operational Status and Commands	68
4-1-2	End Codes	69
4-1-3	Error Codes	71
4-2	Temperature Control Commands (All Controllers)	71
4-2-1	Set Temperature Write: WS	71
4-2-2	Set Temperature Read: RS	73
4-2-3	Measured Temperature Read: RX	74
4-2-4	Writing PID Constant and the Control Period	76
4-2-5	Reading PID Constant and the Control Period	78
4-2-6	Controlling Operation	79
4-2-7	Output Mode Write: WU	80
4-2-8	Output Mode Read: RU	82
4-2-9	Status Read: RX	83
4-2-10	Memory Bank Designation Write: WM	85
4-2-11	Memory Bank Designation Read: RM	86
4-2-12	Autotuning Commands	87
4-2-13	Alarm Mode Write: W#	88
4-2-14	Alarm Mode Read: R#	90
4-2-15	Alarm Temperature Write: W%	91
4-2-16	Alarm Temperature Read: R%	92
4-2-17	EEPROM Write: WE	94
4-2-18	Input Shift Write: WI	95
4-2-19	Input Shift Read: RI	95
4-2-20	Hysteresis Write: WH	96
4-2-21	Hysteresis Read: RH	97
4-2-22	Output Variable Read: RO (RX)	98
4-2-23	Transmission Test: TS	99
4-2-24	Initialize Parameters: MC	99
4-2-25	Error Read: RU	101
4-2-26	Alarm Point Write: WU	103
4-2-27	Alarm Point Read: RU	104
4-2-28	Detection Level Write: WW	105
4-2-29	Detection Level Read: RW	106
4-2-30	Heater Current Read: RZ	107
4-3	Fuzzy Constant Commands (Fuzzy-logic Controllers Only)	109
4-3-1	Fuzzy Constant Write Commands	109
4-3-2	Fuzzy Constant Read Commands	110
4-4	Global Read and Control Operations	111
4-5	Global Write Operations	114

4-1 Overview

4-1-1 Operational Status and Commands

The following list provides the command name, header code, and operation status under which each command can be executed. If the same header code is used with more than one command, the code which serves to distinguish between these commands is placed in parentheses after the header code.

OK indicates where an command can be executed; NO indicates where an command cannot be executed, resulting in an 01 end code in the response (see the next section).

Operational Control and Write Commands

Name	Header code	Operation stopped	Operating	Autotuning	Page
Autotuning Start	AS	NO	OK	NO	87
Autotuning Stop	AP	OK	OK	OK	87
Operation Start	OS	OK	OK	NO	80
Operation Stop	OP	OK	OK	OK	80
Initialize Parameters	MC	OK	NO	NO	99
Transmission Test	TS	OK	OK	OK	99
Alarm Mode Write	W#	OK	NO	NO	88
Alarm Temperature Write	W%	OK	OK	OK	91
Proportional Band Write	WB	OK	OK	NO	76
EEPROM Write	WE	OK	OK	OK	94
Hysteresis Write	WH	OK	OK	NO	96
Input Shift Write	WI (Note 2)	OK	OK	NO	95
Memory Bank Designation Write	WM	OK	OK	NO	85
Integral Time Write	WN	OK	OK	NO	77
Set Temperature Write	WS	OK	OK	NO	71
Control Period Write	WT	OK	OK	NO	77
Output Mode Write	WU (00)	OK	NO	NO	80
Alarm Point Write	WU (02)	OK	NO	NO	80
Derivative Time Write	WV	OK	OK	NO	77
Detection Level Write	WW	OK	OK	OK	105
Fuzzy Strength Write (Note 1)	Wj	OK	OK	NO	109
Fuzzy Scale 1 Write (Note 1)	Wk	OK	OK	NO	109
Fuzzy Scale 2 Write (Note 1)	WI (Note 3)	OK	OK	NO	109

- Note**
1. Fuzzy-logic Controllers Only
 2. Capital letter, "I" [ai].
 3. Small letter, "i" [ei].

Read Commands

Name	Header code	Operation stopped	Operating	Autotuning	Page
Alarm Mode Read	R#	OK	OK	OK	90
Alarm Temperature Read	R%	OK	OK	OK	92
Proportional Band Read	RB	OK	OK	OK	78
Hysteresis Read	RH	OK	OK	OK	97
Input Shift Read	RI (Note 2)	OK	OK	OK	95

Name	Header code	Operation stopped	Operating	Autotuning	Page
Memory Bank Designation Read	RM	OK	OK	OK	86
Integral Time Read	RN	OK	OK	OK	78
Output Variable Read	RO	OK	OK	OK	98
Set Temperature Read	RS	OK	OK	OK	73
Control Period Read	RT	OK	OK	OK	78
Output Mode Read	RU (00)	OK	OK	OK	82
Error Read	RU (03)	OK	OK	OK	82
Alarm Point Read	RU (02)	OK	OK	OK	82
Derivative Time Read	RV	OK	OK	OK	78
Detection Level Read	RW	OK	OK	OK	106
Measured Temperature Read	RX (00)	OK	OK	OK	74
Status Read	RX (02)	OK	OK	OK	74
Output variable read	RX	OK	OK	OK	74
Heater Current Read	RZ	OK	OK	OK	107
Fuzzy Strength Read (Note 1)	Rj	OK	OK	OK	110
Fuzzy Scale 1 Read (Note 1)	Rk	OK	OK	OK	110
Fuzzy Scale 2 Read (Note 1)	RI (Note 3)	OK	OK	OK	110

- Note**
1. Fuzzy-logic Controllers Only
 2. Capital letter, "l" [ai].
 3. Small letter, "l" [el].

Caution The only header code that does not appear in the above table is IC. This code is not used with any command, but is returned in the response when the header code in any command is not received in a recognizable form. The host computer must be programmed to recognize this header code and respond properly, i.e., normally to re-send the last command. The response format for the IC header code is as shown below.

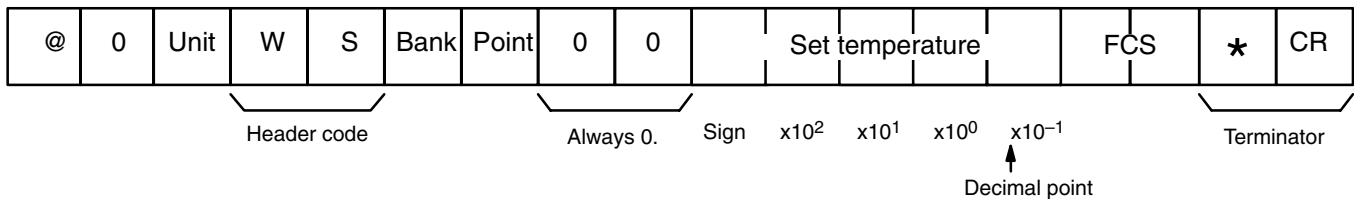

4-1-2 End Codes

When a response is returned by the E5ZD, the header code is followed by a two-character end code that indicates the execution status of the command. The only exception is when the header code of an command is not recognizable, in which case a header code of IC is returned without an end code.

An end code of 00 indicates that the command was executed normally. Any other end code indicates some problem in the execution of the command as described in detail below. The end codes and the basic meaning of them are the same for any command. They are listed individually with the commands only when specific causes, directly related to use of an command, are likely.

Caution The host computer must be programmed to deal appropriately with end codes.

Normal End: 00	The command was executed normally.
Prohibited Command: 01	The command cannot be executed under the current operating status, e.g., attempting to write certain data during autotuning.
Invalid Address: 04	The point number is not between 0 and 4 for 4-point models, between 0 and 5 for 6-point models, between 0 and 7 for 8-point models; or the memory bank number is not between 0 and 7.
Parity Error: 10	The parity bit is not consistent with the data.
Framing Error: 11	The stop bit was not detected.
Overflow Error: 12	The reception buffer has overflowed.
FCS Error: 13	The FCS was either incorrectly calculated or the transmitted data has been affected by noise.
Format Error: 14	The required number of digits has not been received. Normally indicates that the data length, e.g., the number of digits required for a setting, is not correct.
Numeric Error: 15	Data specified for an command is not within specified limits. Be sure that the basic parameters affecting numeric values (e.g., the Celsius/Fahrenheit setting) are correct and that the decimal point has been taken into consideration.
Frame Length Error: 18	The command block has exceeded 127 characters.
Invalid Command due to Setting Restrictions: 19	Execution was not possible because of some relationship to other parameters. This end code will be generated if an attempt is made to change the alarm mode such that the alarm temperature range is exceeded by the current alarm temperature. Confirm temperature limits when changing the alarm mode.
Invalid command due to Error Status: 21	Execution was not possible because an error exists that must be cleared. Possible errors include memory errors, A/D conversion errors, cold junction compensation errors, and setting errors. If an error exists, the Measured Temperature Read command can be used to read out the type of error that as occurred.
End Code Priority	<p>If multiple end codes are generated by execution of a single command, only the end code with the highest priority will be returned with the response. End code priority, from highest to lowest, is as follows:</p> <ol style="list-style-type: none">1. Framing errors2. Parity errors3. Overflow errors4. Frame length errors5. FCS errors6. Address errors7. Format errors8. Error status9. Prohibited command errors10. Numeric errors11. Invalid commands due to setting restrictions

If an end code of 00 was returned in the response, the command was executed normally. If the end code is not 00, the measured temperature will not have been read.

4-1-3 Error Codes

If an error has occurred that makes temperature measuring impossible, Measured Temperature Read will result in a response that contains an error code that indicates what type of error has occurred. The detail of response formats are described on page 76.

Error code	Name	Meaning
E001	Memory error	The memory contents have been destroyed. Turn the E5ZD off and on.
E002	Sensor input AD error	The sensor AD converter has failed. Turn the E5ZD off and on.
E003	Cold junction compensation error	This error is generated when CN3 has been disconnected or the ambient temperature of the E5ZD has dropped below -15°C or exceeded 60°C .
E004	CT input AD error	The CT input AD converter has failed.
E011	Sensor error	The sensor input is not correct. Either the sensor is shorted or not wired correctly.
E012	Upper limit error	The measured temperature is 20°C or more over the set temperature range.
E013	Lower limit error	The measured temperature is 20°C or more below the set temperature range.
E022	Heater current upper limit error	The measured heater current value is more than 55 A.

4-2 Temperature Control Commands (All Controllers)

The commands described in this section are used to write or read parameters used in temperature control, or to otherwise exert temperature control.

4-2-1 Set Temperature Write: WS

This command is used to write the set values for temperature control into memory. The command must designate the unit, memory bank, and point where the set temperature is to be written. The length of the data for the set temperature is either four for five digits depending on whether the value is input to the nearest degree or to the nearest one-tenth of a degree (see below).

It designates only the set temperatures, not the current memory bank, which is specified using Memory Bank Designation Write (WM).

Note Set Temperature Write cannot be used during autotuning.

Command Format

The formats for this command are as shown below.

The following format is used with K or J sensors or when the temperature range for Pt100 or JPt100 sensors is between 0° and 500°C (32° to 932°F). In either case, the set temperature is input in four digits (or three numeric digits with a sign digit) with increments of one degree. Use $2D_{\text{hex}}$ as the negative sign.

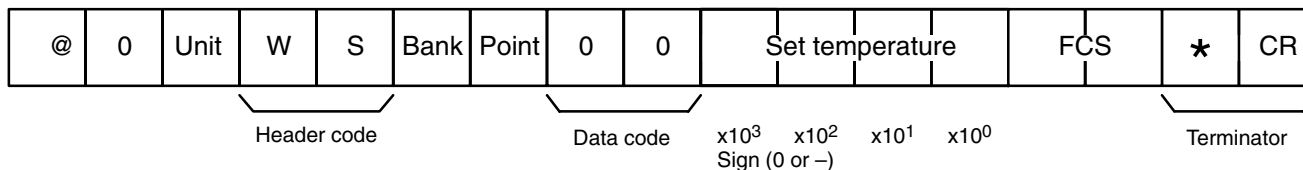

The following format is used with Pt100 or JPt100 sensors when the temperature range is between -100.0° and 200.0°C (-148° to 392°F). In this case, the

set temperature is input in five digits (i.e., a sign digit plus four numeric digits) in increments of one tenth degree. Be sure to consider the decimal point when inputting data. Use 2D_{hex} as the negative sign.

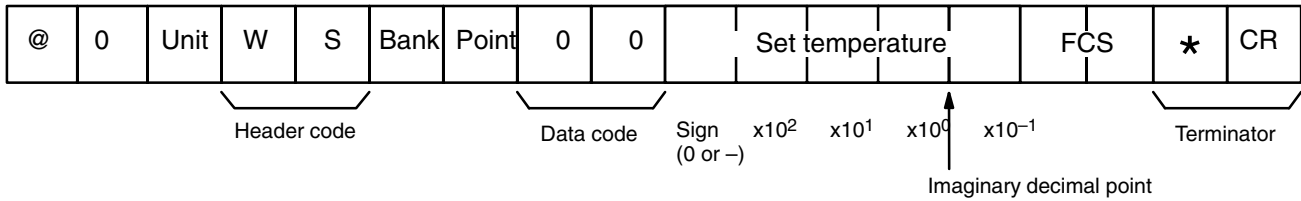

Command Examples

The following command is used to write a set temperature of 23°C in memory bank 0 of control point 0 of unit 0 for an E5ZD model using a K sensor which is set to a temperature range of 0° to 600°C.

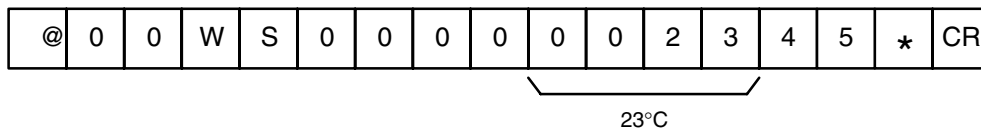

The following command is used to write a set temperature of 1,000°F in memory bank 2 of control point 1 of unit 1 for a E5ZD model using a K sensor which is set to a temperature range of 32° to 1112°F.

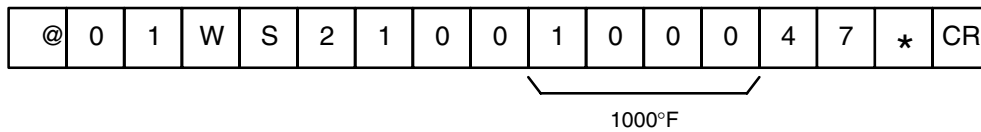

The following command is used to write a set temperature of -100.0°F in memory bank 7 of control point 5 of unit F for a E5ZD model using a Pt sensor which is set to a temperature range of -148.0° to 392°F.

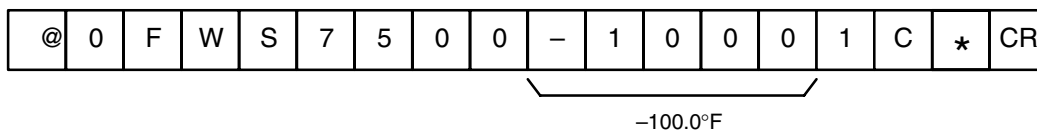

Response Format

The response returned for this command is shown below. This response assumes that the header code in the command block was transmitted and read normally. If the header code in the command block was not recognizable, a header code of IC will be returned without an end code (see Section 4-1-2 End Codes for the IC header code response format).

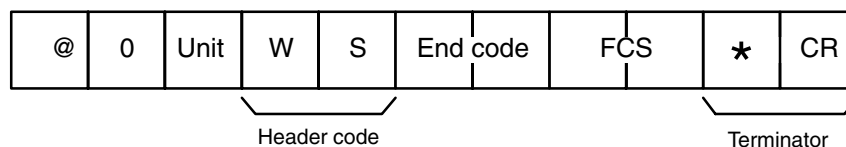

End Codes

If an end code of 00 was returned in the response, the command was executed normally. If the end code is not 00, the desired data will not have been written. Refer to *Section 4-1-2 End Codes* for a description of the other possible end codes and their meanings.

For Set Temperature Write, end code 14 and 15 may result from improper switch settings, i.e., the required number of digits and the smallest increment for the set temperature data differ depending on the model and the set temperature range.

4-2-2 Set Temperature Read: RS

This command is used to read the set temperatures that are held in the memory banks. It is necessary to designate the unit, point, and bank of the desired set temperature.

Command Format

The format for this command is as shown below.

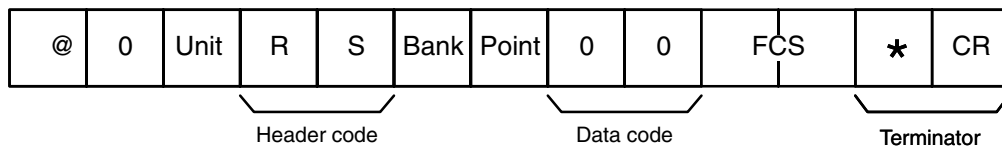

Command Examples

The following command is used to read the set value stored in memory bank 2 of control point 0 in unit 1.

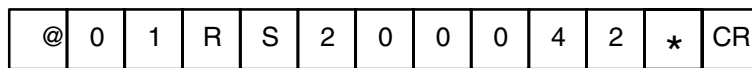

Response Format

The responses returned for this command are shown below. The response used depends on the smallest increment of the set temperature (see below). These responses assume that the header code in the command block was transmitted and read normally and that the end code is 00. If the end code is not 00, the set value will not have been returned and the end code will be followed immediately by the FCS. If the header code in the command block was not recognizable, a header code of IC will be returned without an end code (see *Section 4-1-2 End Codes* for the IC header code response format).

The following format is used with K or J sensors, or when the temperature range for Pt100 or JPt100 sensors is between 0° and 500°C (32° to 932°F). In either case, the set temperature is returned in four digits (or three numeric digits with a sign digit) in increments of one degree. 2D_{hex} is used as the negative sign.



The following format is used with Pt100 or JPt100 sensors when the temperature range is between -100.0° and 200.0°C (-148° to 392°F). In this case, the set temperature is returned in five digits (i.e., a sign digit plus four numeric digits)

in increments of one-tenth of a degree. Be sure to consider the decimal point when reading the data. 2D_{hex} is used as the negative sign.

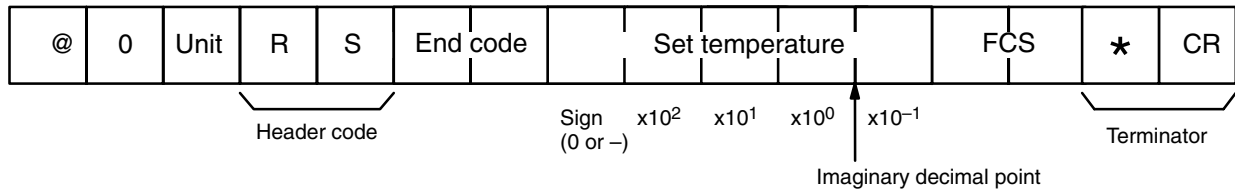

Response Examples

The following response shows that a temperature of 5°C is set in memory bank 0 of control point 0 in unit 2 for an E5ZD using a K sensor which is set to a temperature range of 0° to 400°C.

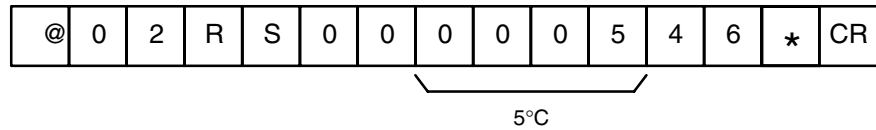

The following response shows that a temperature of -50.3°C is set in memory bank 0 of control point 0 in unit 2 for an E5ZD using a Pt100 sensor which is set to a temperature range of -100.0° to 200.0°C.

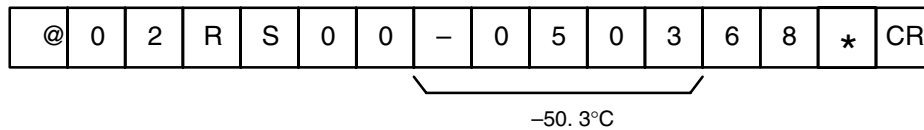

The following response shows that a temperature of 1,023°F is set in memory bank 0 of control point 0 in unit 2 for an E5ZD using a K sensor which is set to a temperature range of 32° to 1112°F.

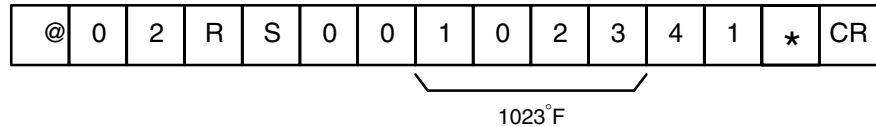

The following response shows that the E5ZD was not able to read the RS header code when an attempt was made to read from unit 0.

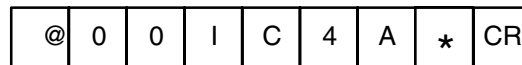

End Codes

If an end code of 00 was returned in the response, the command was executed normally. If the end code is not 00, the set temperature will not have been returned. Refer to *Section 4-1-2 End Codes* for a description of the other possible end codes and their meanings.

4-2-3 Measured Temperature Read: RX

This command is used either to read the temperature being measured for any control point or, if executed when an error exists, to access more information about the error.

Command Format

The format for this command is as shown below. The control point and unit number must be specified and the data code must be 00.

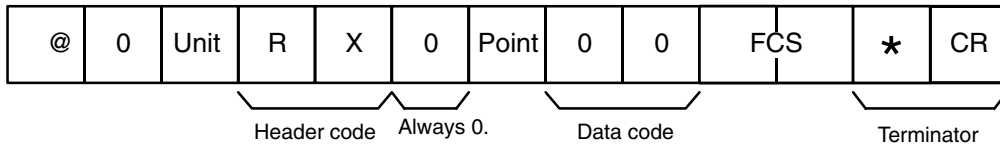

Command Examples

The following command is used to read the temperature being measured for control point 0 of unit 1.

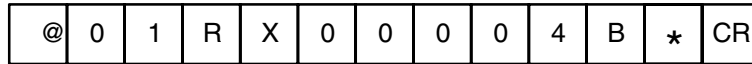

Response Format

The responses returned for this command are shown below. The response used depends on the smallest increment of the measured temperature (see below). These responses assume that the header code in the command block was transmitted and read normally, and that the end code is 00. If the end code is not 00, the measured temperature will not have been returned and the end code will be followed by an error code (see below). If the header code in the command block was not recognizable, a header code of IC will be returned without an end code (see *Section 4-1-2 End Codes* for the IC header code response format).

The following format is used with K or J sensors or when the temperature range for Pt100 or JPt100 sensors is between 0° and 500°C (32° to 932°F). In either case, the measured temperature is returned in four digits (or three numeric digits with a sign digit) in increments of one degree. 2D_{hex} is used as the negative sign.

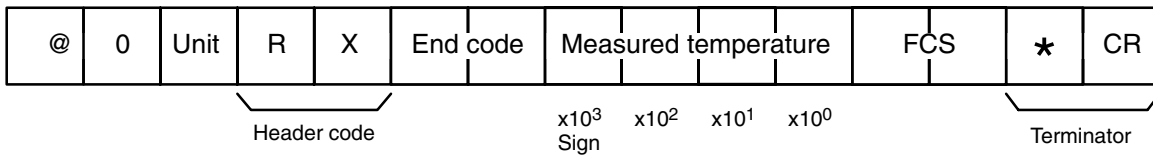

The following format is used with Pt100 or JPt100 sensors when the temperature range is between -100.0° and 200.0°C (-148° to 392°F). In this case, the measured temperature is returned in five digits (i.e., a sign digit plus four numeric digits) in increments of one-tenth of a degree. Be sure to consider the decimal point when reading the data. 2D_{hex} is used as the negative sign.

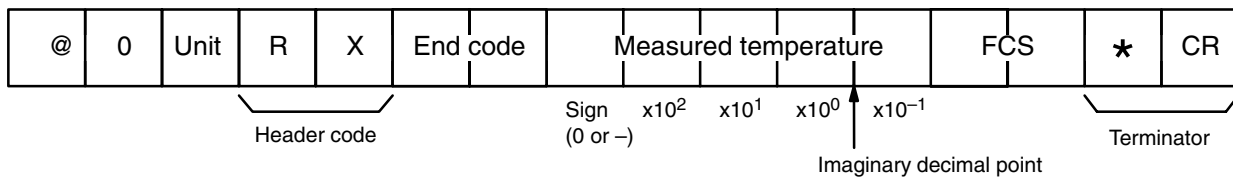

Response Examples

The following response shows that -5°C is being measured for control point 0 of unit 1. A K sensor is used and the temperature range is 0° to 400°C.

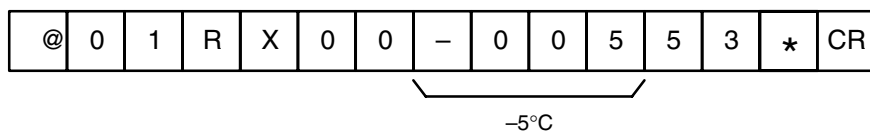

Error Codes

If an error has occurred that makes temperature measuring impossible, Measured Temperature Read will result in a response that contains an error code that indicates what type of error has occurred. The response formats are shown below, and the error codes are described on 4-1-3 Error Codes.

The following format is used with K or J sensors or when the temperature range for Pt100 or JPt100 sensors is between 0° and 500°C (32° to 932°F). In either case, the error code is returned in four digits.

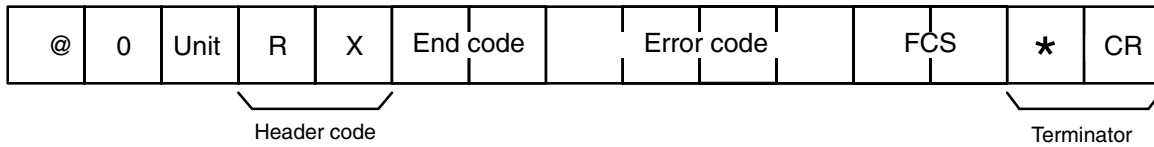

The following format is used with Pt100 or JPt100 sensors when the temperature range is between -100.0° and 200.0°C (-148° to 392°F). In this case, the error code is returned in four digits preceded by a space.

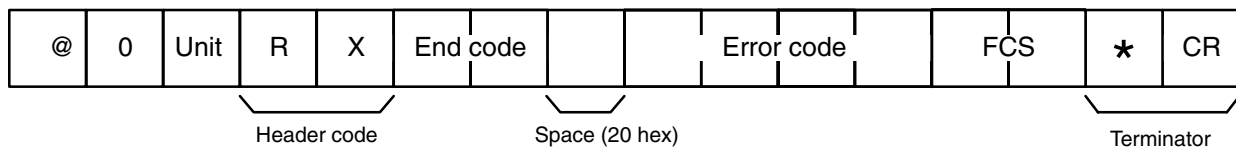

End Codes

If an end code of 00 was returned in the response, the command was executed normally. If the end code is not 00, the measured temperature will not have been read. Refer to Section 4-1-2 End Codes for a description of the other possible end codes and their meanings.

4-2-4 Writing PID Constant and the Control Period

This section covers four commands: Proportional Band Write, Integral Time Write, Derivative Time Write, and Control Period Write. The command and response formats for these are nearly the same, however the numeric values for data do vary. Make sure that values are within the ranges given below.

Command Format

The formats for these commands and the limits for numeric data are given below. All of these commands require the unit number, control point, and memory bank for which the write is intended. All require the four-digit data for the constant to be preceded by two zeros.

Proportional Band Write: WB

The proportional band is input between 000.0° and 999.9°C. The setting of SW5 determines whether the value is in Celsius or Fahrenheit. The decimal point is assumed and does not need to be entered; be sure to consider it when inputting. If all zeros is input, ON-OFF control will be used.

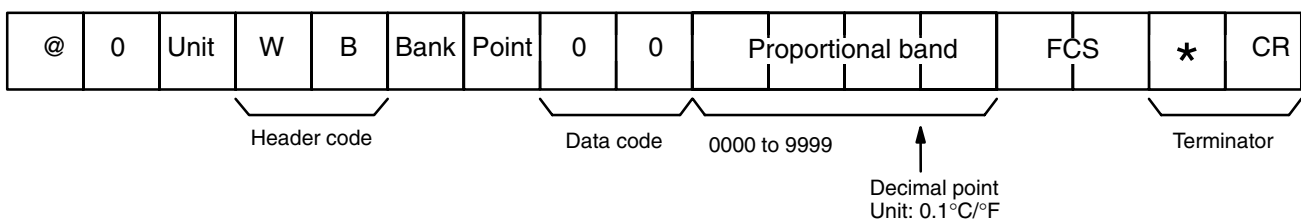

Integral Time Write: WN

The integral time is input in seconds (between 0000 and 3999). Setting 0000 will turn integral operation OFF.

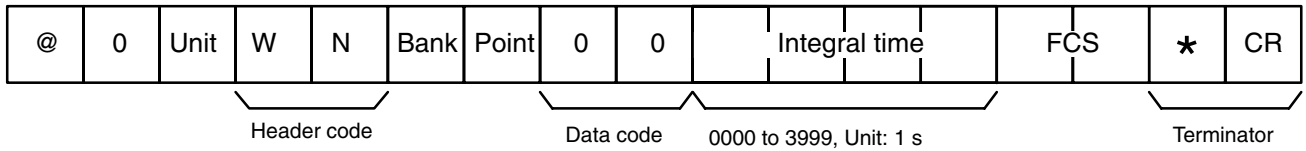

Derivative Time Write: WV

The derivative time is input in seconds and can be between 0000 and 3999. Setting 0000 will turn derivative operation OFF.

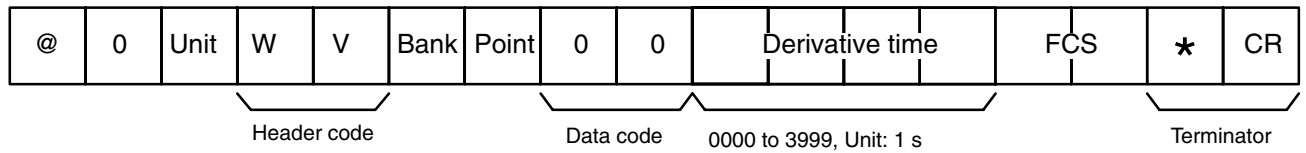

Control Period Write: WT

The control period is input in seconds and can take a value between 0001 and 0099.

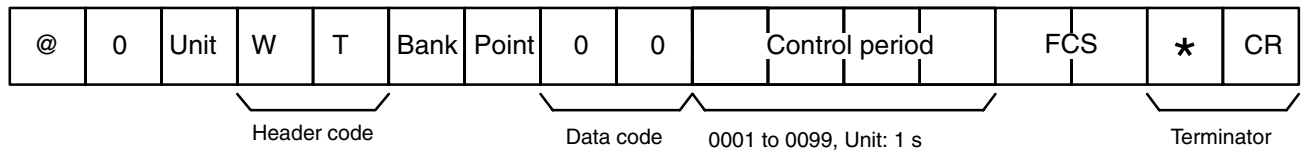

Command Examples

The following command is used to set a 50°C proportional band in memory bank 3 for control point 2 of unit 1.

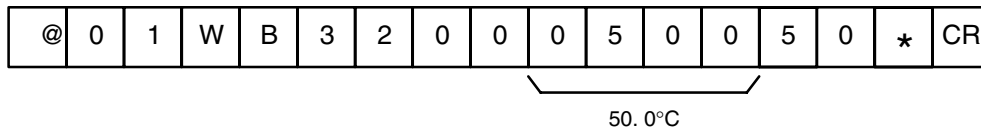

Response Formats

The responses returned for these commands are shown below. These responses assume that the header code in the command block was transmitted and read normally. If the header code in the command block was not recognizable, a header code of IC will be returned without an end code (see Section 4-1-2 End Codes for the IC header code response format).

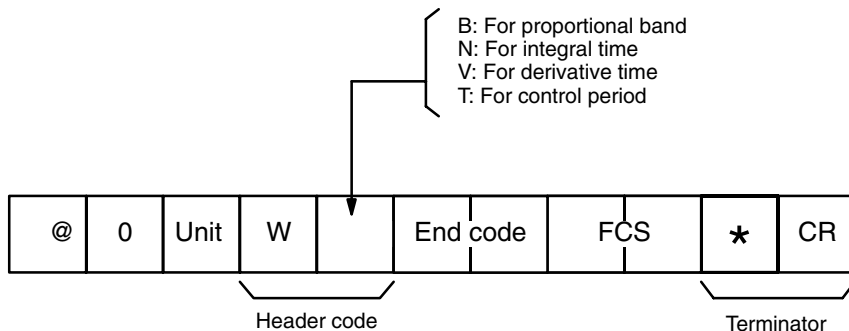

End Codes

If an end code of 00 was returned in the response, the command was executed normally. If the end code is not 00, the desired data will not have been written. Refer to *Section 4-1-2 End Codes* for a description of the other possible end codes and their meanings.

4-2-5 Reading PID Constant and the Control Period

This section covers four commands: Proportional Band Read, Integral Time Read, Derivative Time Read, and Control Period Read. The command and response formats for these are nearly the same. The numeric values returned for data do vary.

Note The following commands can not used during autotuning.

Command Format

The formats for all of these commands require the unit number, control point, and memory bank for which the read is intended.

Proportional Band Read: RB

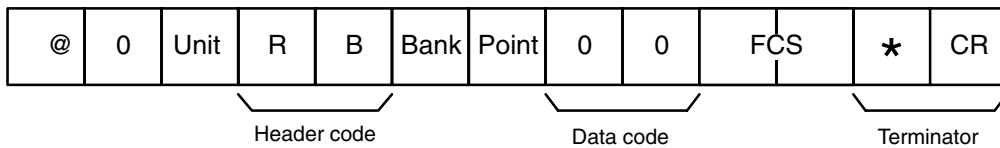

Integral Time Read: RN

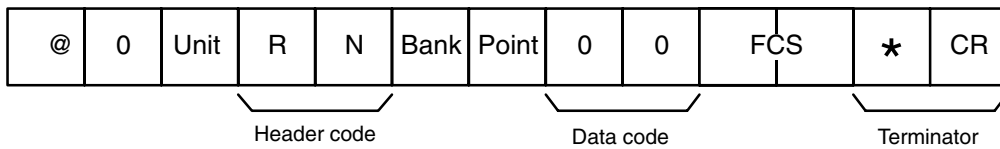

Derivative Time Read: RV

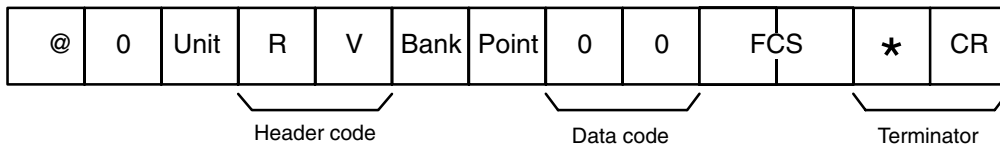

Control Period Read: RT

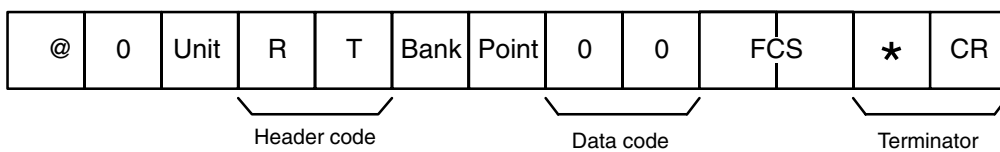

Command Examples

The following command is used to read the proportional band in memory bank 3 for control point 2 of unit 1.

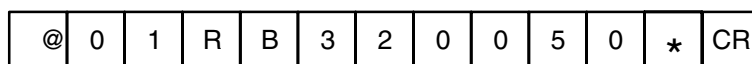

Response Formats

The responses returned for these commands are shown below. These responses assume that the header code in the command block was transmitted and read normally and that the end code is 00. If the end code is not 00, the desired value will not have been returned and the end code will be followed immediately by the FCS. If the header code in the command block was not recognizable, a header code of IC will be returned without an end code (see *Section 4-1-2 End Codes* for the IC header code response format).

The proportional band will be between 000.0° and 999.9°C. The setting of SW5 determines whether the value is in Celsius or Fahrenheit. The decimal point is assumed and is not returned in the response; be sure to take this into consideration when reading.

The integral and derivative times will be in seconds with values between 0000 and 3999. The control period is also in seconds, but can take a value between 0001 and 0099.

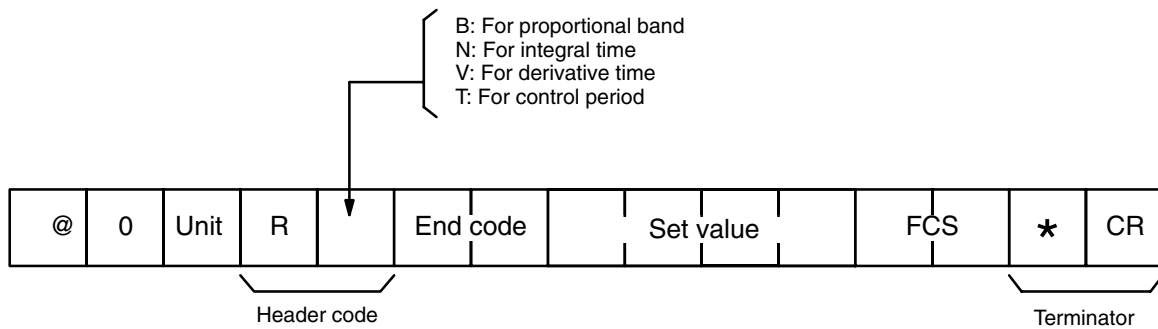

Response Examples

This response shows that a proportional band of 50.3°C is set in memory bank 3 for control point 2 of unit 1.

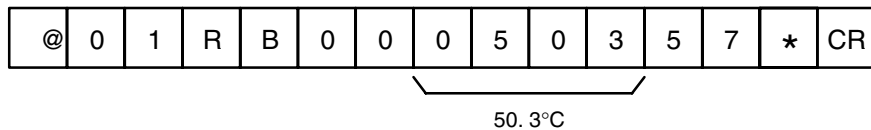

End Codes

If an end code of 00 was returned in the response, the command was executed normally. If an end code other than 00 is returned, the desired value will not have been read. Refer to *Section 4-1-2 End Codes* for a description of the other possible end codes and their meanings.

4-2-6 Controlling Operation

This section covers two commands: Operation Start, and Operation Stop. These commands are used to start PID operation unless PID operation has not been set (i.e., when the proportional band is set to 0000). If PID operation has not been set, these commands simply start and stop E5ZD operation.

If Operation Start is sent during autotuning, an error will be generated and end code 01 will be returned. Operation Stop can be used to stop operation during autotuning. Operation Start will be ignored if the Unit is already operating.

Note Operation Start cannot be used during autotuning.

Command Formats

The formats for these commands are as shown below. Both of these commands require specification of the control point and the unit number to be started or stopped.

Operation Start: OS

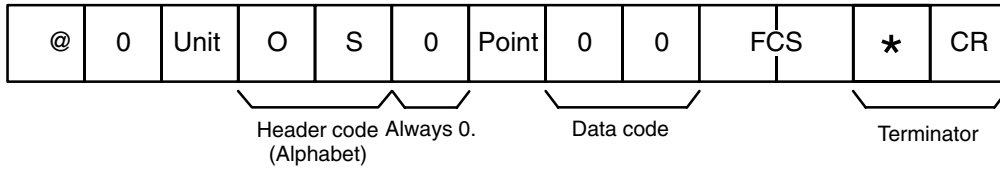

Operation Stop: OP

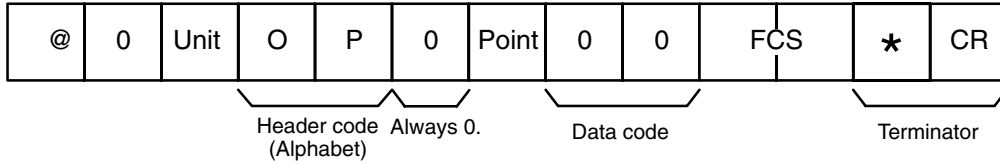

Command Examples

The following command is used to start operation of control point 1 of unit 1.

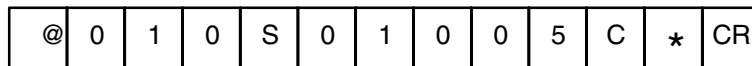

The following command is used to stop operation of control point 1 of unit 1.

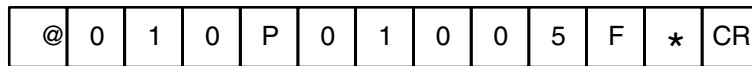

Response Format

The responses returned for these commands are shown below. These responses assume that the header code in the command block was transmitted and read normally. If the header code in the command block was not recognizable, a header code of IC will be returned without an end code (see Section 4-1-2 End Codes for the IC header code response format).

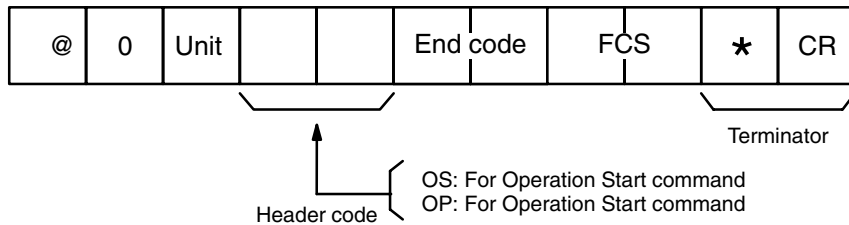

End Codes

If an end code of 00 was returned in the response, E5ZD operation was started or stopped normally. If any other end code is returned, the command was not completed successfully. Refer to Section 4-1-2 End Codes for a description of the other possible end codes and their meanings.

4-2-7 Output Mode Write: WU

This command is used to designate the operation mode of the control points. Designation can be either for cooling (normal) or heating (reverse) operation. All control points are set for heating control at the factory. This command is therefore only necessary to change the operation mode of any point(s) where cooling mode is required. This command cannot be used if one or more of the points is autotuning. Use this command only after stopping both normal operation and autotuning with an Operation Stop (OPERATE) command.

Command Format

The format for this command is as shown below. The number of the unit whose points are to be set must be specified. Each of the bits 0 through 7 of the setting data is assigned to a control point as shown below. If the bit for a control point is OFF (0), heating operation (the default) is specified. If the bit is ON (1), cooling operation is specified. Bits not used by the specified unit must be set to 0. An error with an end code of 15 will result if these bits are not 0.

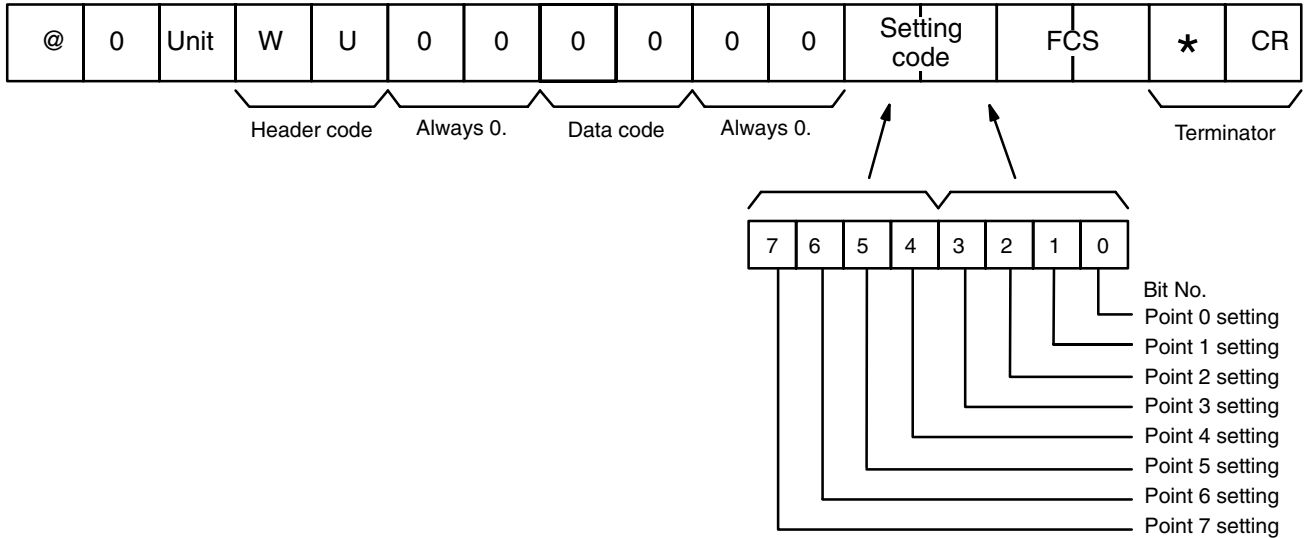

To determine the value to be input for the desired setting, convert the bits to two-digit hexadecimal values and then convert the digits independently to ASCII code. For example, the value to change all points for a 6-point E5ZD to cooling operation would be 3F_{hex}. A 3 in ASCII is 33 in hexadecimal, and F converts to 46. The two digits of the setting would thus be 33_{hex}, 46_{hex}.

Command Examples

The following command is used to set points 0, 2, and 4 of unit 2 for heating operation and points 1, 3, and 5 to cooling operation

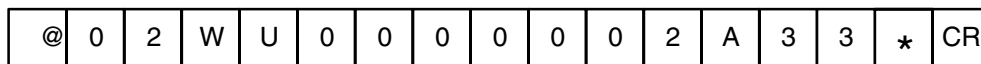

Response Format

The response returned for this command is shown below. This response assumes that the header code in the command block was transmitted and read normally. If the header code in the command block was not recognizable, a header code of IC will be returned without an end code (see Section 4-1-2 End Codes for the IC header code response format).

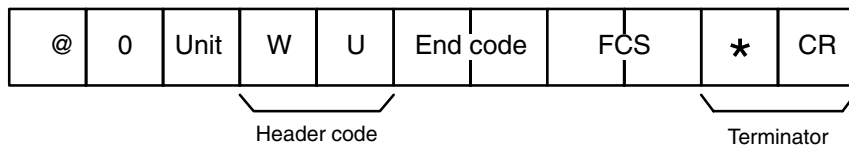

End Codes

If an end code of 00 was returned in the response, the command was executed normally. If the end code is not 00, the desired data will not have been written. Refer to Section 4-1-2 End Codes for a description of the other possible end codes and their meanings.

4-2-8 Output Mode Read: RU

This command is used to read the output mode settings, i.e., either cooling or heating operation, for the control points of a Unit. The factory default setting for all points is for heating operation.

Command Format

The format for this command is as shown below. The unit number and a data code of 00 must be specified. (Other data codes are used to read different data.)

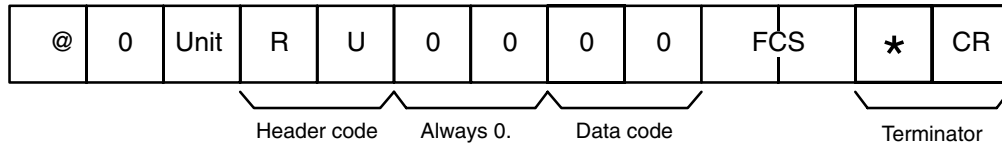

Command Examples

The following command is used to read the output modes set for the control points of unit 2.

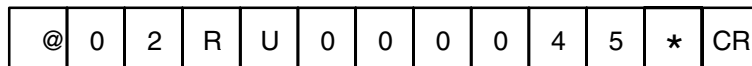

Response Format

The response returned for this command is shown below. This response assumes that the header code in the command block was transmitted and read normally and that the end code is 00. If an end code other than 00 is returned, the desired data will not have been read and the end code will be followed immediately by the FCS. If the header code in the command block was not recognizable, a header code of IC will be returned without an end code (see Section 4-1-2 End Codes for the IC header code response format). Bits for unused points will be set to 0.

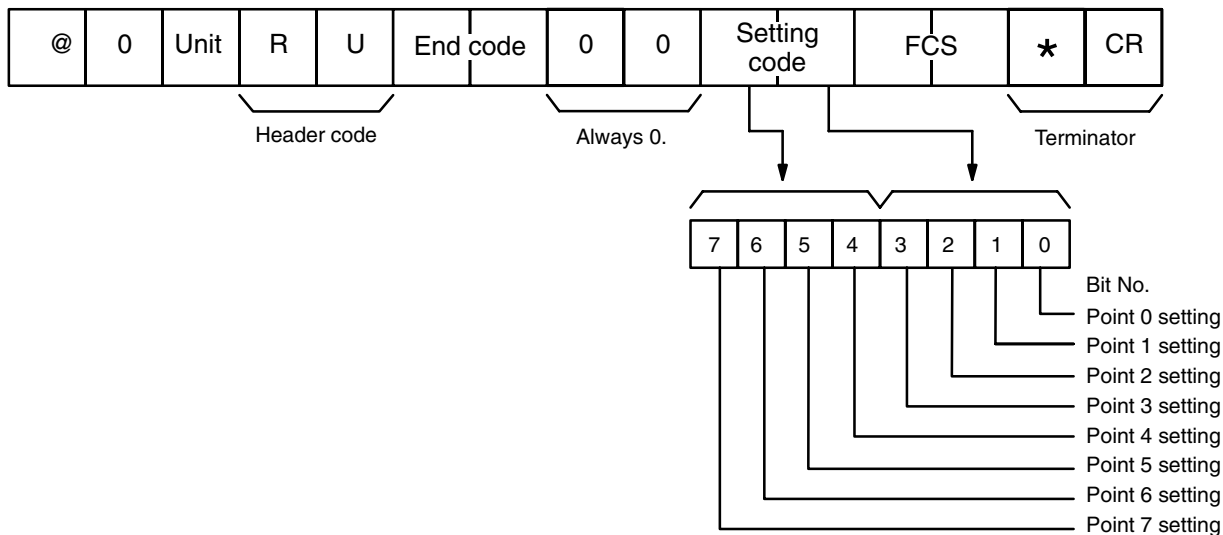

Bit status, meaning, and conversion methods are the same as those used to set the output mode using Output Mode Write. Refer to *Output Mode Write* for details.

Response Examples

This response shows that cooling operation has been set for control points 0 through 2 of unit 2 and that the rest of the control points of unit 2 are set for heating operation.

@	0	2	R	U	0	0	0	0	0	7	4	2	*	CR
---	---	---	---	---	---	---	---	---	---	---	---	---	---	----

End Codes

If an end code of 00 was returned in the response, the command was executed normally. If the end code is not 00, the desired data will not have been read. Refer to *Section 4-1-2 End Codes* for a description of the other possible end codes and their meanings.

4-2-9 Status Read: RX

This command is used to read the operating status of the E5ZD. This includes control, alarm, and error status. The actual contents of errors can be checked by means of RU data code 03.

Command Format

The format for this command is as shown below. The unit number and control point must be specified, and the data code must be 02.

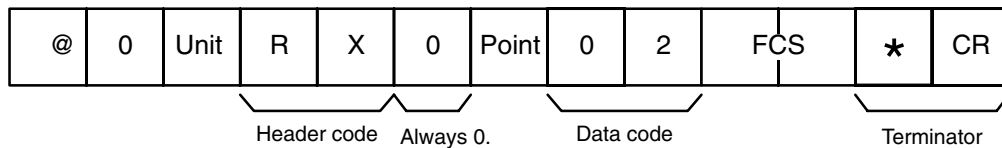

Command Examples

The following command is used to read the status of control point 0 of unit 1.

@	0	1	R	X	0	0	0	2	4	9	*	CR
---	---	---	---	---	---	---	---	---	---	---	---	----

Response Format

The response returned for this command is shown below. This response assumes that the header code in the command block was transmitted and read normally and that the end code is 00. If the end code is not 00, status will not have been read and the end code will be followed immediately by the FCS. If the header code in the command block was not recognizable, a header code of IC will be

returned without an end code (see Section 4-1-2 End Codes for the IC header code response format).

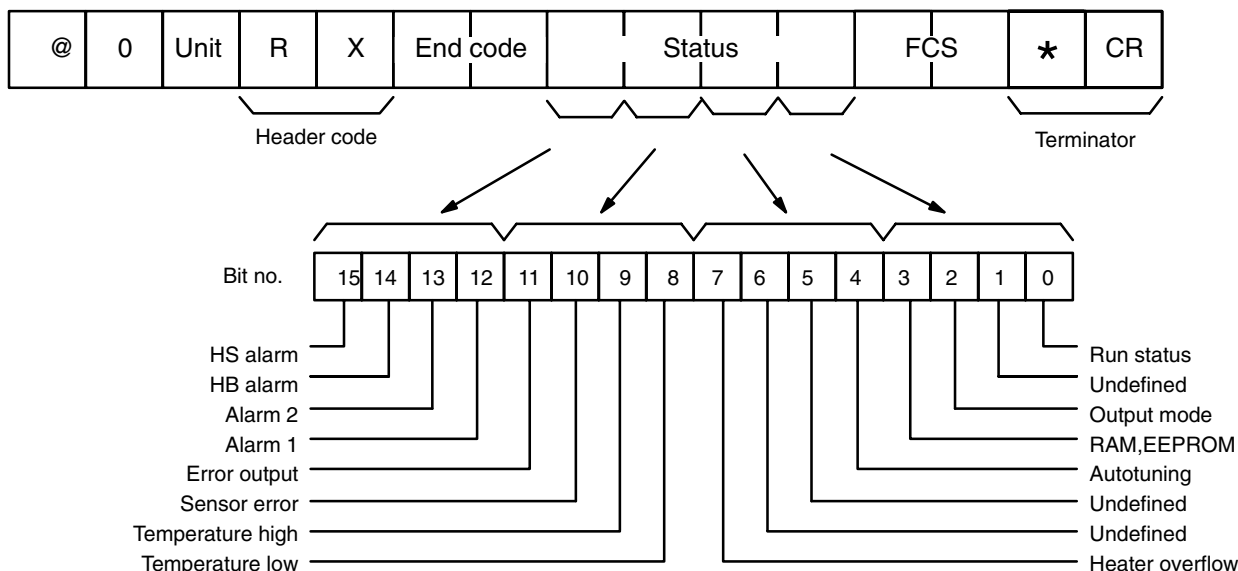

The meaning of the four digits of status data read are described in the following table. Details are also provided below for some of these.

Bit no.	Function	Meaning when ON (1)	Meaning when OFF (0)
0	RUN flag	E5ZD is operating.	E5ZD is off.
1	Not used.	Undefined.	Undefined.
2	Output mode	Cooling	Heating
3	RAM-EEPROM flag	Contents differ.	Contents are the same.
4	Autotuning flag	Autotuning.	Not autotuning.
5	Not used.	Undefined.	Undefined.
6	Not used.	Undefined.	Undefined.
7	Heater Overflow flag	Current is too large.	Current is normal.
8	Temperature Low flag	Measured temperature is too low.	Measured temperature is OK.
9	Temperature High flag	Measured temperature is too high.	Measured temperature is OK.
10	Sensor Error flag	Sensor error.	Sensor is OK.
11	Error Output flag	Error output is ON.	Error output is OFF.
12	Alarm 1 flag	Alarm 1 output is ON.	Alarm 1 output is OFF.
13	Alarm 2 flag	Alarm 2 output is ON.	Alarm 2 output is OFF.
14	HB Alarm flag	HB alarm output is ON.	HB alarm output is OFF.
15	HS Alarm flag	HS alarm output is ON.	HS alarm output is OFF.

Bit 3: RAM-EEPROM Flag

This flag turns ON whenever an command writes data to RAM to indicate that the contents of RAM and EEPROM differ. It will remain ON until the EEPROM Write command is used to transfer RAM contents to EEPROM again.

Bit 7: Heater Overflow Flag

This flag turns ON to indicate that the measured heater current has exceeded 55 A.

Bit 8: Temperature Low Flag

This flag turns ON to indicate that the measured temperature has dropped below the set temperature range by 20°C or more.

Bit 9: Temperature High Flag

This flag turns ON to indicate that the measured temperature has exceeded the set temperature range by 20°C or more.

Bit 10: Sensor Error Flag

This flag turns ON to indicate that the sensor has been incorrectly wired, that the sensor circuit is broken, or that a temperature input from the sensor has exceeded the control temperature range.

Response Examples

This response shows that, for the specified control point of unit 2, the E5ZD is operating in heating mode, RAM and EEPROM contents are the same, autotuning is OFF, and that there are no error or alarm outputs ON except for the alarm 1 output, which is ON.

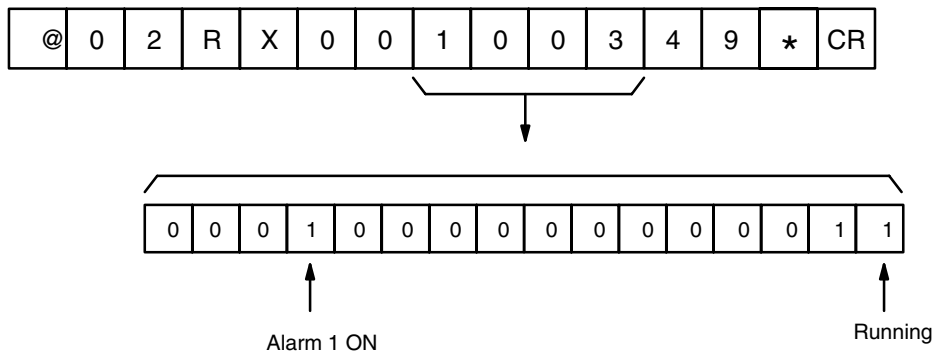

End Codes

If an end code of 00 was returned in the response, the command was executed normally. If the end code is not 00, the desired data will not have been read. Refer to Section 4-1-2 End Codes for a description of the other possible end codes and their meanings.

4-2-10 Memory Bank Designation Write: WM

This command is used to designate which of the eight memory banks is to be used with the specified control point. The parameters in the specified memory bank will be used for further operation. Also, it can only be used when SW5 is set to allow the designation of memory banks via commands.

Note This command cannot be used during autotuning.

Command Format

The format for this command is as shown below. The unit number and control point must be specified.

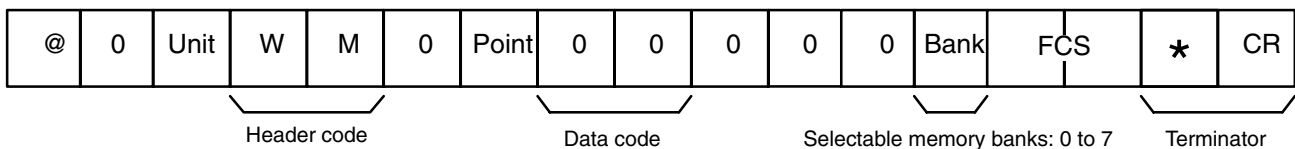

Command Examples

The following command is used to designate memory bank 2 as the current memory bank for control point 3 of unit 1.

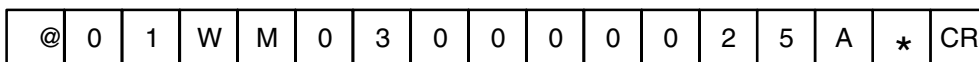

Response Format

The response returned for this command is shown below. This response assumes that the header code in the command block was transmitted and read normally. If the header code in the command block was not recognizable, a header code of IC will be returned without an end code (see *Section 4-1-2 End Codes* for the IC header code response format).

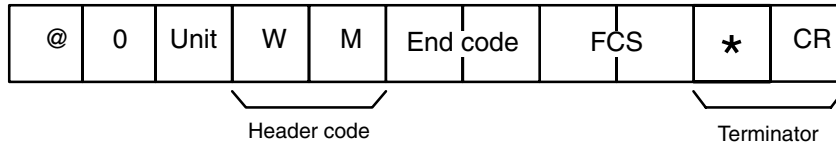

End Codes

If an end code of 00 was returned in the response, the command was executed normally. If the end code is not 00, the desired data will not have been written. For WM, a 01 end code will be generated if the memory bank designation method has been set to “contact valid” by the DIP switch (it is set to “communications valid” at the time of shipping.). Refer to *Section 4-1-2 End Codes* for a description of the other possible end codes and their meanings.

4-2-11 Memory Bank Designation Read: RM

This command is used to read out which memory bank is currently specified for a specified control point.

Command Format

The format for this command is as shown below. The unit number and control point must be specified.

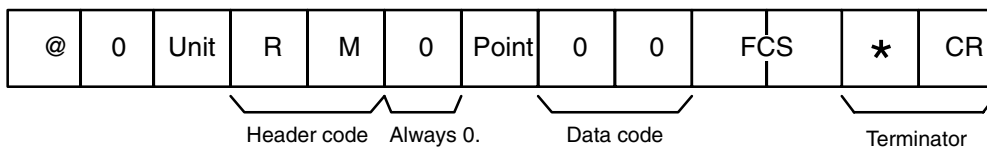

Response Format

The response returned for this command is shown below. This response assumes that the header code in the command block was transmitted and read normally and that the end code is 00. If the end code is not 00, the desired data will not have been read and the end code will be followed immediately by the FCS. If the header code in the command block was not recognizable, a header code of IC will be returned without an end code (see *Section 4-1-2 End Codes* for the IC header code response format).

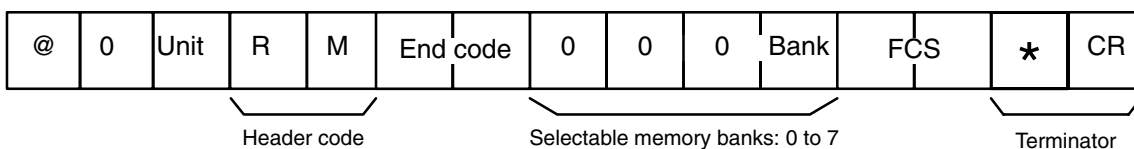

Response Examples

This response shows that memory bank 3 is currently specified for control point 0 of unit 2.

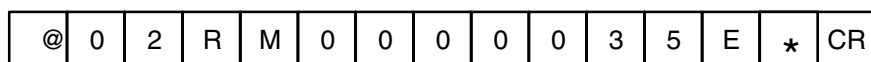

End Codes

If an end code of 00 was returned in the response, the command was executed normally. If the end code is not 00, the desired data will not have been read. Refer to *Section 4-1-2 End Codes* for a description of the other possible end codes and their meanings.

4-2-12 Autotuning Commands

Autotuning is used to automatically calculate and set the PID constants. The control point for which autotuning is to be started must already be in operation (use Operation Start). Also, if an attempt is made to start autotuning when it is already in progress, an error will result and an end code of 01 will be returned.

When autotuning is stopped, the values that have been determined are automatically written in as the PID constants, and normal operation is continued.

Depending on the control object, the optimum PID constants may not always be obtained. In such cases, set the PID constants manually. Also set them manually if hunting should occur in the control system.

When autotuning is finished, the values of fuzzy scales 1 and 2 will be automatically set according to the measured PID constants for Fuzzy-logic Controllers.

The two commands used for autotuning are Autotuning Start, AS, and Autotuning Stop, AP.

Command Formats

The formats for these commands are as shown below. The unit number and control point must be specified for Autotuning Start. The unit number must be specified for Autotuning Stop, but the control point cannot be, i.e., autotuning for all control points is stopped simultaneously.

Autotuning Start: AS

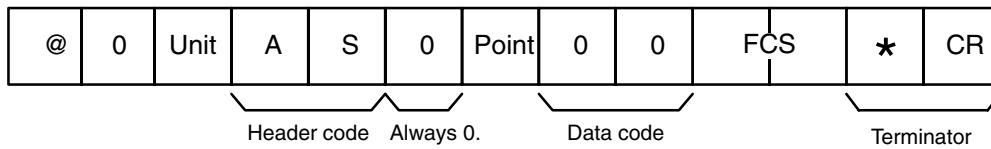

Autotuning Stop: AP

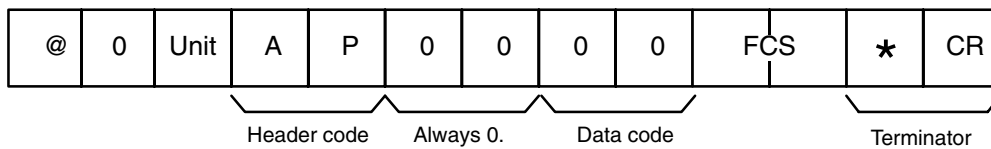

Command Examples

The following command is used to start autotuning for control point 3 of unit 2.

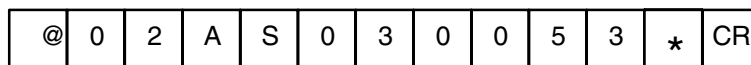

Response Format

The response returned for this command is shown below. This response assumes that the header code in the command block was transmitted and read normally. If the header code in the command block was not recognizable, a

header code of IC will be returned without an end code (see *Section 4-1-2 End Codes* for the IC header code response format).

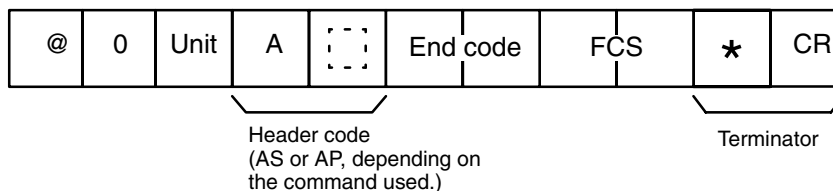

End Codes

If an end code of 00 was returned in the response, the command was executed normally. If the end code is not 00, the command will not have been executed. Refer to *Section 4-1-2 End Codes* for a description of the other possible end codes and their meanings.

Precautions

Although autotuning can be executed for either heating or cooling operation and during startup, temperature rise, or stable operation, best results will be achieved if autotuning is executed under normal operating conditions, including the actual set temperature (PID constants will vary with the set temperature).

Autotuning will not end if executed without an active controlled system, e.g., without a heater connected or without the heater being turned on.

Autotuning can require ten or more hours to complete under certain conditions. If extensive time is required, try setting the P constant to zero and then restart autotuning.

Autotuning will not achieve optimum PID constants for all controlled systems. If autotuning does not achieve satisfactory results, set PID constants manually.

Hunting can result during autotuning because a limit cycle is used. If hunting is undesirable for the controlled system, set PID constants manually.

Autotuning must be restarted if a power interruption occurs.

Sequential activation of autotuning is possible by using a 01 data code. Autotuning will start from the smallest numbered point that is active and continue to the next active point when autotuning finishes for the previous point.

The HB and HS alarms will not work for points that are being autotuned.

The values of fuzzy scales 1 and 2 will be automatically adjusted according to the PID constants that have been determined by autotuning. The values of fuzzy scales 1 and 2 can be manually set after the PID constants have been set if different values are desired.

4-2-13 Alarm Mode Write: W#

This command is used to set the operating modes for alarm outputs 1 and 2. The modes for these outputs are set independently and can differ. The alarm outputs, however, will be turned ON whenever an error exists for any active point. The alarm mode can only be set when the specified control point is not operating. If it is operating (or autotuning), an error will result and a 01 end code will be returned. An alarm will not function unless the relevant point is operating.

Command Format

The format for this command is as shown below. The unit number, control point, and alarm must be specified along with the desired mode.

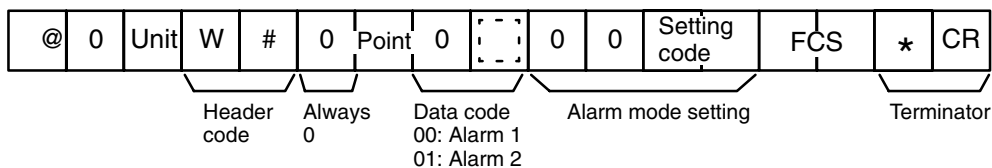

Mode setting	Mode	Alarm output (▲ indicates alarm temp.)
00	Alarm OFF	OFF
01	Upper and lower limit alarm	
02	Upper limit alarm	
03	Lower limit alarm	
04	Upper and lower limit range alarm	
05	Upper and lower limit alarm with standby sequence	
06	Upper limit alarm with standby sequence	
07	Lower limit alarm with standby sequence	
08	Absolute value upper limit alarm	
09	Absolute value lower limit alarm	
0A	Absolute value upper limit alarm with standby sequence	
0B	Absolute value lower limit alarm with standby sequence	
0C	HB and HS alarm	Same operation as HB and HS alarm

Note: Negative setting will result in the following type of operation.

Upper limit alarm with negative setting

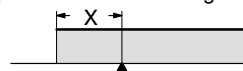

Lower limit alarm with negative setting



Each standby sequence is indicated by dotted lines. During each standby sequence period, the alarm output is not turned ON until the measured temperature reaches the set alarm value or if you have done one of the following:

- Turned power on
- Started control
- Changed the memory bank
- Changed the control temperature
- Changed the alarm temperature

Command Examples

The following command is used to designate mode 2 (upper limit alarm) for control point 3 of unit 2.

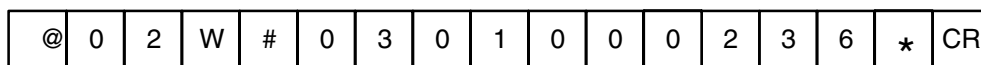

Response Format

The response returned for this command is shown below. This response assumes that the header code in the command block was transmitted and read

normally. If the header code in the command block was not recognizable, a header code of IC will be returned without an end code (see Section 4-1-2 End Codes for the IC header code response format).

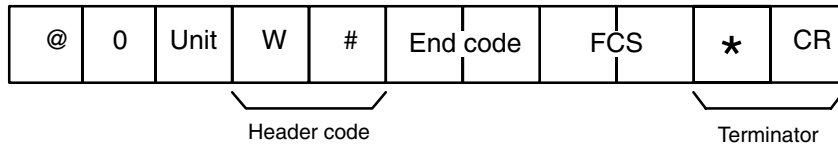

End Codes

If an end code of 00 was returned in the response, the command was executed normally. If the end code is not 00, the desired data will not have been written. Refer to Section 4-1-2 End Codes for a description of the other possible end codes and their meanings.

4-2-14 Alarm Mode Read: R#

This command is used to read the operation mode setting for either alarm 1 or alarm 2.

Command Format

The format for this command is as shown below. The unit number, control point, and alarm must be specified. Refer to Alarm Mode Write for the various operation modes and designations.

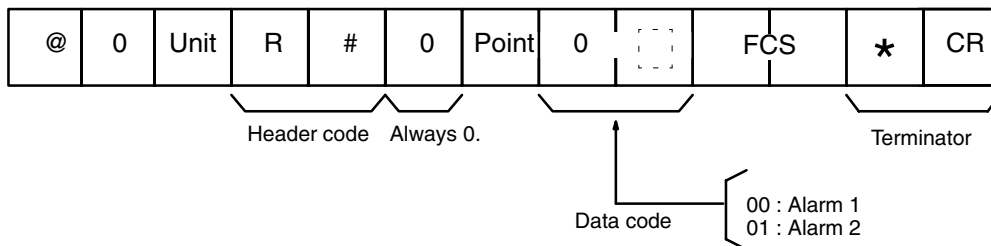

Command Examples

The following command is used to read the mode set for alarm 2 for control point 3 of unit 2.

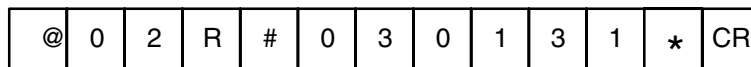

Response Format

The response returned for this command is shown below. This response assumes that the header code in the command block was transmitted and read normally and that the end code is 00. If the end code is not 00, the desired data will not have been read and the end code will be followed immediately by the FCS. If the header code in the command block was not recognizable, a header code of IC will be returned without an end code (see Section 4-1-2 End Codes for the IC header code response format).

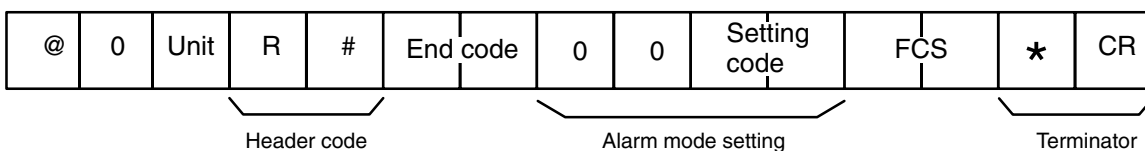

End Codes

If an end code of 00 was returned in the response, the command was executed normally. If the end code is not 00, the desired data will not have been read. Refer to *Section 4-1-2 End Codes* for a description of the other possible end codes and their meanings.

4-2-15 Alarm Temperature Write: W%

This command is used to set the temperatures for alarm outputs 1 and 2. These temperatures are set by control point and by alarm.

Doing so will result in an error, and a 01 end code will be returned.

Note This command cannot be used during autotuning.

Command Formats

The formats for these commands are as shown below. The unit number, memory bank, control point, and alarm must be specified along with the alarm temperature. The command format and values allowed for the alarm temperature vary with the type of sensor, the set temperature range, and the alarm mode. The allowable values are given in the table following the command formats.

The following format is used with K or J sensors or when the temperature range for Pt100 or JPt100 sensors is between 0° and 500°C (32° to 932°F). In either case, the alarm temperature is input in four digits (or three numeric digits with a sign digit) in increments of one degree. Use 2D_{hex} as the negative sign.

When Setting Unit is 1

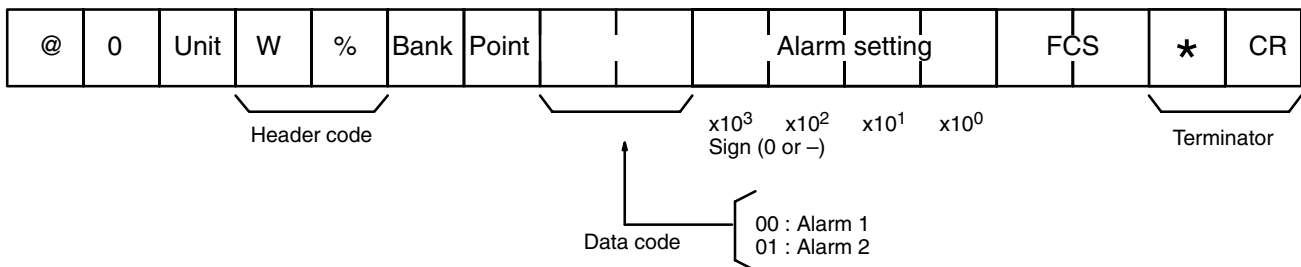

The following format is used with Pt100 or JPt100 sensors when the temperature range is between -100.0° and 200.0°C (-148° to 392°F). In this case, the alarm temperature is input in five digits (i.e., a sign digit plus four numeric digits) in increments of one-tenth of a degree. It is not necessary to input the decimal point, but be sure to consider the decimal point when inputting data. Use 2D_{hex} as the negative sign.

When Setting Unit is 0.1

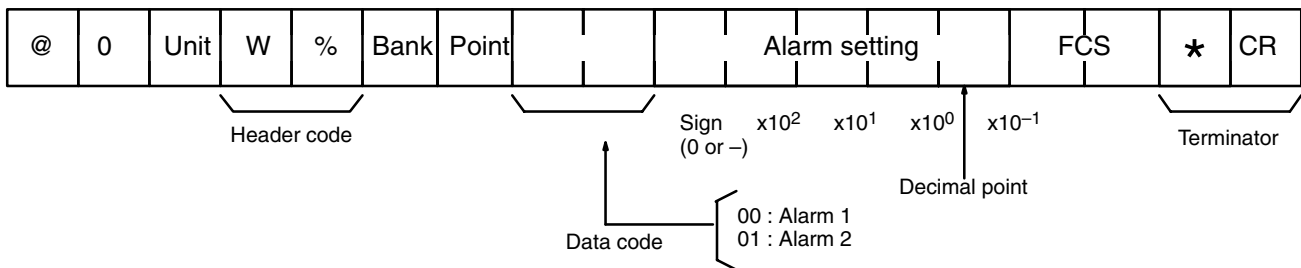

Command Format

The format for this command is as shown below. The unit number, memory bank, control point, and alarm must be specified.

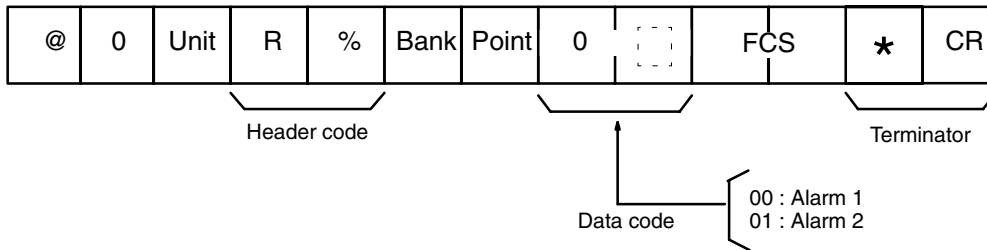

Command Examples

The following command is used to read the alarm temperature setting for alarm 1 in memory bank 2 of control point 1 on Unit 2.

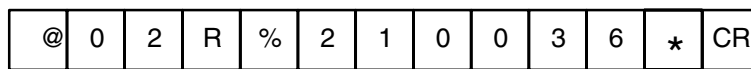

Response Format

The responses returned for this command are shown below. The response differs depending on the type of sensor and the temperature range setting (see below). These responses assume that the header code in the command block was transmitted and read normally and that the end code is 00. If the end code is not 00, the desired data will not have been read and the end code will be followed immediately by the FCS. If the header code in the command block was not recognizable, a header code of IC will be returned without an end code (see Section 4-1-2 End Codes for the IC header code response format).

The following format is used with K or J sensors, or when the temperature range for Pt100 or JPt100 sensors is between 0° and 500°C (32° to 932°F). In either case, the alarm temperature returned is four digits (or three numeric digits with a sign digit) in increments of one degree. 2D_{hex} is used as the negative sign.

When Setting Unit is 1

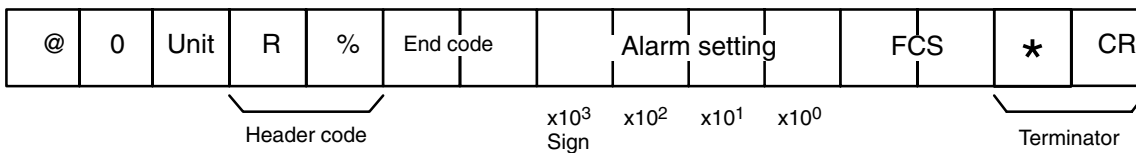

The following format is used with Pt100 or JPt100 sensors when the temperature range is between -100.0° and 200.0°C (-148° to 392°F). In this case, the alarm temperature is returned in five digits (i.e., a sign digit plus four numeric digits) in increments of one-tenth of a degree. The decimal point is not present, but ensure that it is given due consideration when reading the data. 2D_{hex} is used as the negative sign.

When Setting Unit is 0.1

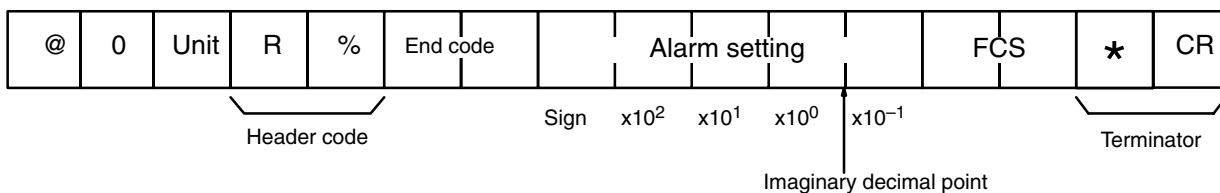

End Codes

If an end code of 00 was returned in the response, the command was executed normally. If the end code is not 00, the desired data will not have been read. Refer to *Section 4-1-2 End Codes* for a description of the other possible end codes and their meanings.

4-2-17 EEPROM Write: WE

This command is used to write the parameters stored in ROM into EEPROM so that they will be preserved if the power is interrupted. This function is used to preserve values when they are initially input, and to permanently store any changes made to the RAM-held parameters. Remember, all commands except for this one affect only the parameters held in RAM; when power is applied to the E5ZD, the values in the EEPROM are returned to RAM.

The EEPROM has a limited overwrite life of approximately 10,000 times; do not use the EEPROM Write command needlessly.

Writing to EEPROM requires time, and the response to EEPROM Write can be delayed by as much as 3.5 seconds for Fuzzy-logic Controllers and as much as 2.3 seconds for other Controllers.

Command Format

The format for this command is as shown below. The unit number must be specified.

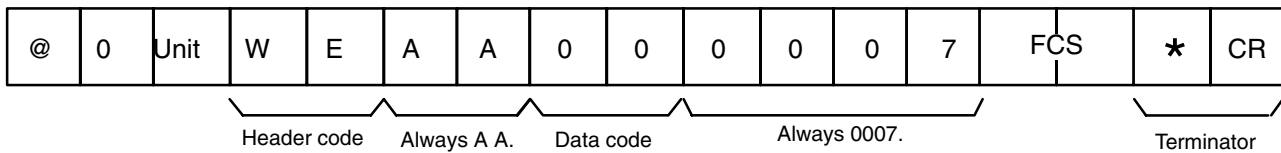

Command Examples

The following command is used to write the parameter of Unit 0 into the EEPROM.

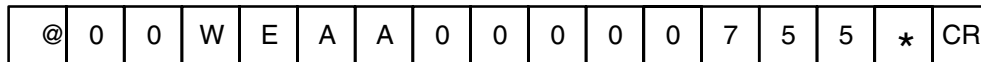

Response Format

The response returned for this command is shown below. This response assumes that the header code in the command block was transmitted and read normally. If the header code in the command block was not recognizable, a header code of IC will be returned without an end code (see *Section 4-1-2 End Codes* for the IC header code response format).

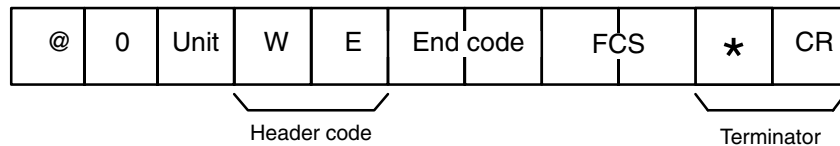

End Codes

If an end code of 00 was returned in the response, the command was executed normally. If the end code is not 00, the desired data will not have been written. Refer to *Section 4-1-2 End Codes* for a description of the other possible end codes and their meanings.

4-2-18 Input Shift Write: WI

This command is used to provide shift for temperature inputs by adding or subtracting fixed values to or from the sensor input. Shift can be set via the memory bank.

Input Shift Write cannot be used during autotuning. Doing so will result in a error and a 01 end code will be returned.

Command Format

The format for this command is as shown below. The unit number, memory bank, and control point must be specified along with the shift. The shift is input in four digits, i.e., a sign digit and three numeric digits. The shift is in tenths of a degree and is set to 0°C at the factory.

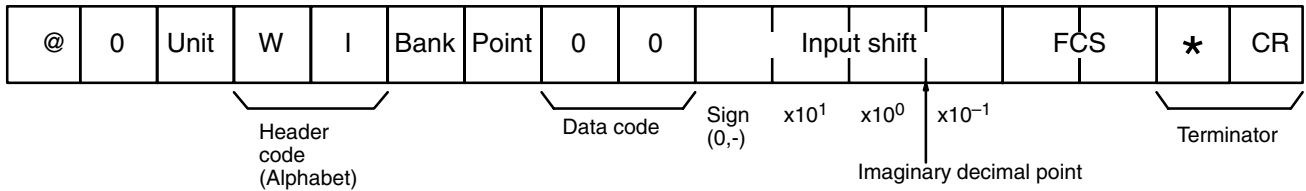

Command Examples

The following command is used to set a -12.3°C shift in memory bank 2 for control point 1 of Unit 2.

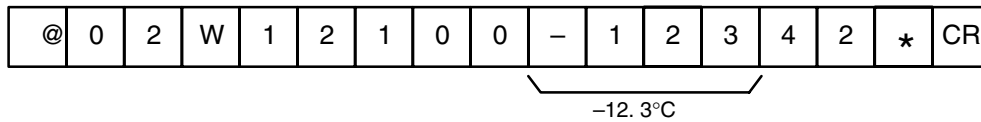

Response Format

The response returned for this command is shown below. This response assumes that the header code in the command block was transmitted and read normally. If the header code in the command block was not recognizable, a header code of IC will be returned without an end code (see Section 4-1-2 End Codes for the IC header code response format).

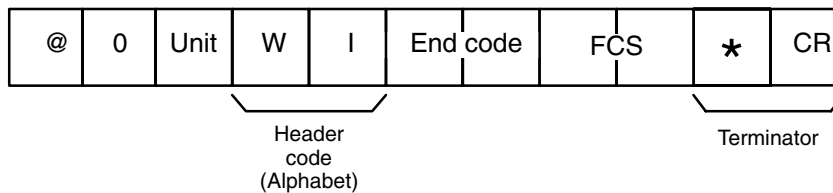

End Codes

If an end code of 00 was returned in the response, the command was executed normally. If the end code is not 00, the desired data will not have been written. Refer to Section 4-1-2 End Codes for a description of the other possible end codes and their meanings.

4-2-19 Input Shift Read: RI

This command is used to read the shift value from the specified memory bank.

Command Format

The format for this command is as shown below. The unit number, memory bank, and control point must be specified.

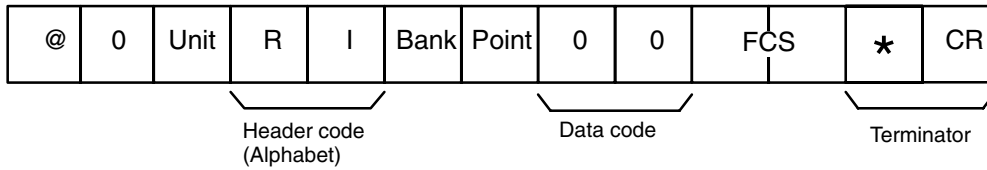

Response Format

The response returned for this command is shown below. This response assumes that the header code in the command block was transmitted and read normally and that the end code is 00. If the end code is not 00, the shift value will not have been read and the end code will be followed immediately by a frame check sequence (FCS). If the header code in the command block was not recognizable, a header code of IC will be returned without an end code (see Section 4-1-2 End Codes for the IC header code response format).

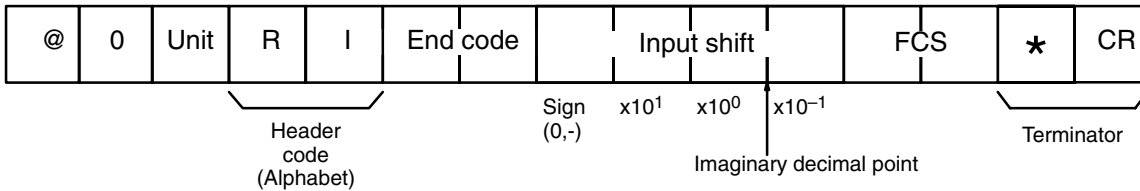

Response Examples

This response shows that a shift value of 12.3°C has been set in memory bank 0 of point 0 in unit 2.

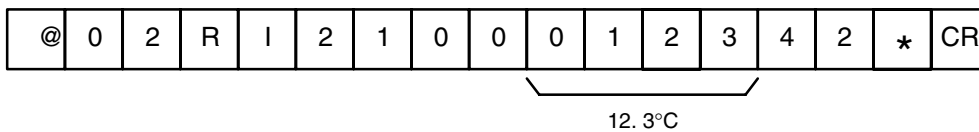

End Codes

If an end code of 00 was returned in the response, the command was executed normally. If the end code is not 00, the desired data will not have been read. Refer to Section 4-1-2 End Codes for a description of the other possible end codes and their meanings.

4-2-20 Hysteresis Write: WH

This command is used to set the hysteresis used in ON/OFF operation. Doing so will result in an error and the end code 01 will be returned.

Note It cannot be used during autotuning.

Command Format

The format for this command is as shown below. The unit number, memory bank number, and control point must be specified along with the hysteresis. The hysteresis is given in three digits to an accuracy of one-tenth of a degree.

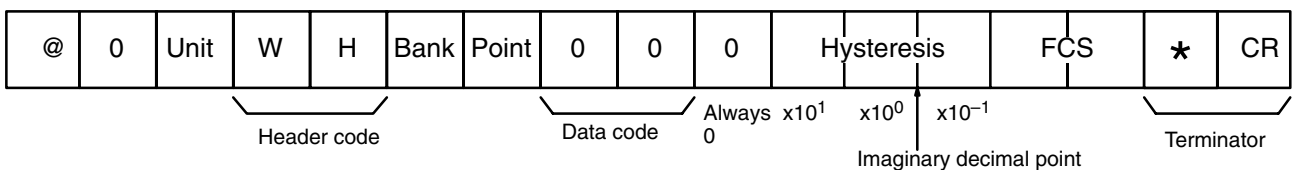

Command Examples

The following command is used to set the hysteresis to 1.5°C in memory bank 2 for control point 1 of Unit 2.

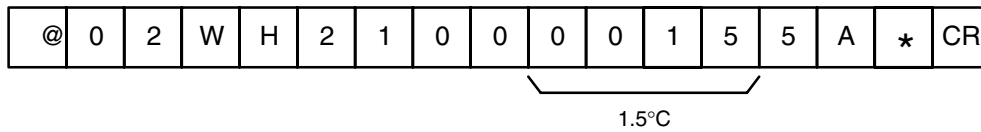

Response Format

The response returned for this command is shown below. This response assumes that the header code in the command block was transmitted and read normally. If the header code in the command block was not recognizable, a header code of IC will be returned without an end code (see Section 4-1-2 End Codes for the IC header code response format).

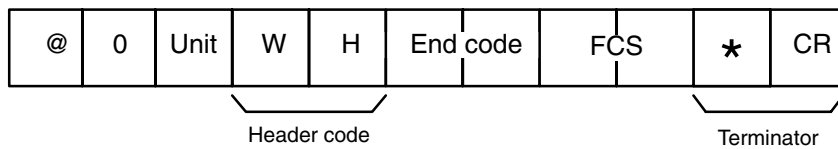

End Codes

If an end code of 00 was returned in the response, the command was executed normally. If the end code is not 00, the desired data will not have been written. Refer to Section 4-1-2 End Codes for a description of the other possible end codes and their meanings.

4-2-21 Hysteresis Read: RH

This command is used to the hysteresis set in the specified memory bank.

Command Format

The format for this command is as shown below. The unit number, memory bank, and control point must be specified.

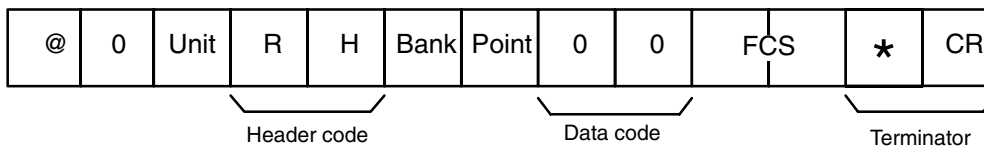

Response Format

The response returned for this command is shown below. This response assumes that the header code in the command block was transmitted and read normally and that the end code is 00. If the end code is not 00, the hysteresis will not have been read and the end code will be followed immediately by the FCS. If the header code in the command block was not recognizable, a header code of IC will be returned without an end code (see Section 4-1-2 End Codes for the IC header code response format).

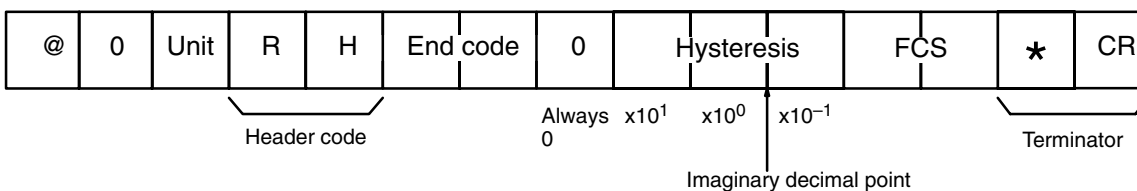

Response Examples

This response shows a hysteresis of 12.3°C set in memory bank 0 for control point 0 of Unit 2.

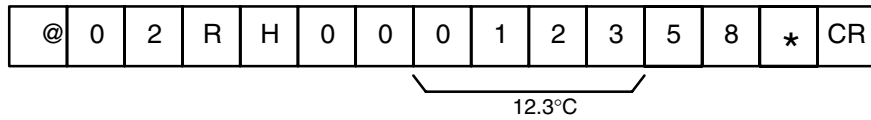

End Codes

If an end code of 00 was returned in the response, the command was executed normally. If the end code is not 00, the desired data will not have been read. Refer to *Section 4-1-2 End Codes* for a description of the other possible end codes and their meanings.

4-2-22 Output Variable Read: RO (RX)

This command is used to read the percentage of output for the specified control point.

Command Format

The format for this command is as shown below. Either a header code of RO with a data code of 00 or a header code of RX with a data code of 01 can be used. The unit number and control point must be specified.

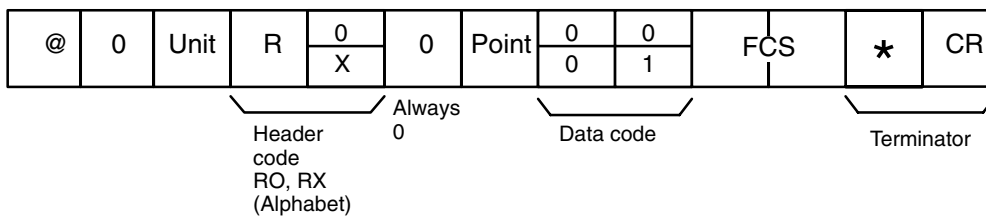

Response Format

The response returned for this command is shown below. The same header code as the one used in the command is returned. This response assumes that the header code in the command block was transmitted and read normally and that the end code is 00. If the end code is not 00, the output percentage will not have been read and the end code will be followed immediately by the FCS. If the header code in the command block was not recognizable, a header code of IC will be returned without an end code (see *Section 4-1-2 End Codes* for the IC header code response format).

The output value is returned as a four-digit percentage with an accuracy of one-tenth of a percent.

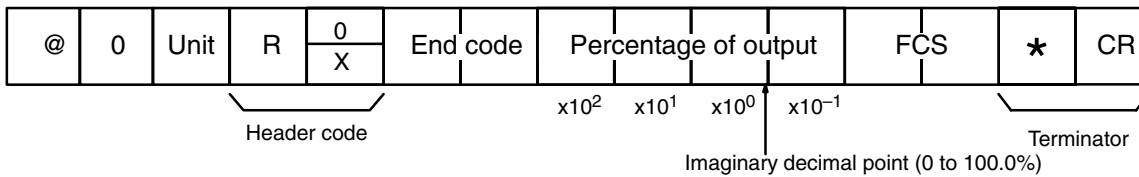

Response Examples

This response shows an output of 99.9% for Unit 0.

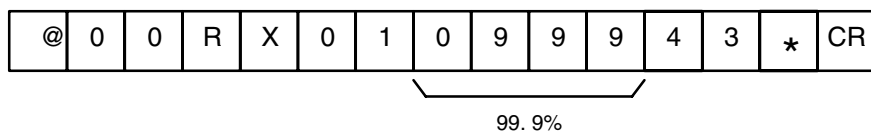

End Codes

If an end code of 00 was returned in the response, the command was executed normally. If the end code is not 00, the desired data will not have been read. Refer to *Section 4-1-2 End Codes* for a description of the other possible end codes and their meanings.

4-2-23 Transmission Test: TS

This command is used to test communications between the host computer and the E5ZD. If the test is successful, the E5ZD will return the same character string as it received.

Command Format

The format for this command is as shown below. The unit number is required along with the character string that is to be returned.

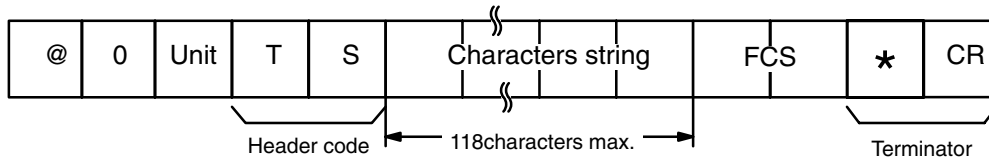

Response Format

The response returned for this command is shown below. This response assumes that the header code in the command block was transmitted and read normally. If the header code in the command block was not recognizable, a header code of IC will be returned (see *Section 4-1-2 End Codes* for the IC header code response format).

There is no end code returned for this command; the character string is used to determine the success of the test.

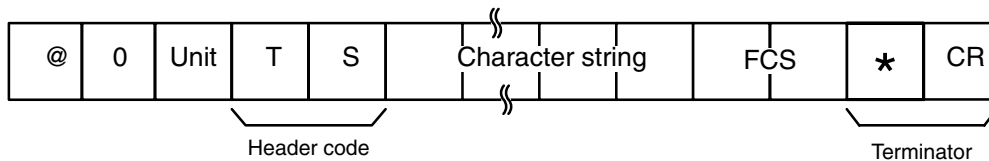

Command/Response Examples

The command and response formats for successfully sending the test string “ABC123” to Unit 1 are shown below.

Command

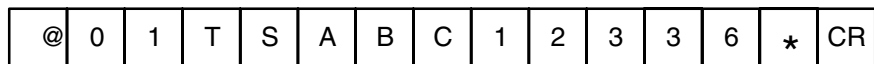

Response

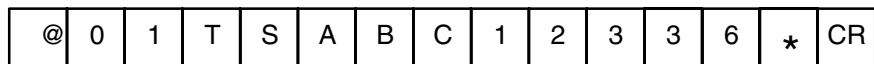

End Codes

End codes are not used in the response to this command.

4-2-24 Initialize Parameters: MC

This command is used to reset RAM to the factory-set default parameters. Only the parameters shown in the table below are reset; all others will retain their current values.

Initialize Parameters does not affect the contents of EEPROM. To save the default values (or further modifications of them) to EEPROM, use EEPROM Write.

Initialize Parameters can be used only when the E5ZD is stopped and only for all control points at once, i.e., control points cannot be individually initialized.

The values inside of the parentheses are the default setting when the setting unit is 0.1.

Parameter	Default	Remarks
HB/HS alarm point	0000	All control points OFF
Current memory bank	0000	Bank 0 for all control points
Output mode	0000	Heating operation for all control points
Alarm 1 mode	0000	No alarm for all control points
Alarm 2 mode	0000	No alarm for all control points
HB alarm level	0000	No HB alarm for all control points
Set temperature	°C: 0000 (00000)	0°C
	°F: 0032 (00320)	32°F
Hysteresis	°C: 0008	0.8°C
	°F: 0015	1.5°F
Input shift	0000	No shift
Proportional band	0000	ON/OFF operation
Integral time	0000	No integral operation
derivative time	0000	No derivative operation
Control period (heating side)	0002	2 seconds
Alarm 1 alarm temperature	0000 (00000)	0°C/0°F
Alarm 2 alarm temperature	0000 (00000)	0°C/0°F
Fuzzy strength	0050	50% of full strength
Fuzzy scale 1	9999	999.9°C or 999.9°F
Fuzzy scale 2	9999	99.99°C/s or 99.99°F/s

Command Format

The format for this command is as shown below. The unit number must be specified.

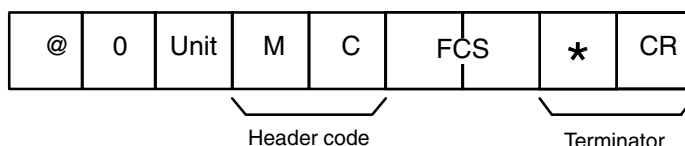

Command Examples

The following command is used to initialize parameters for Unit 1.

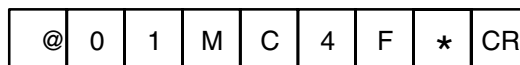

Response Format

The response returned for this command is shown below. This response assumes that the header code in the command block was transmitted and read normally. If the header code in the command block was not recognizable, a

header code of IC will be returned without an end code (see Section 4-1-2 End Codes for the IC header code response format).

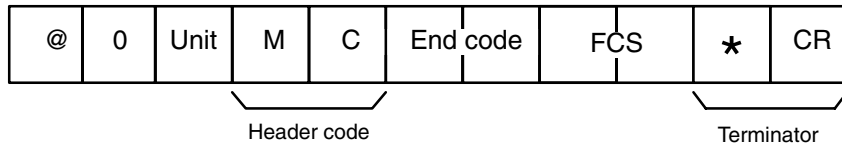

End Codes

If an end code of 00 was returned in the response, the command was executed normally. If the end code is not 00, parameters will not have been initialized. Refer to Section 4-1-2 End Codes for a description of the other possible end codes and their meanings.

4-2-25 Error Read: RU

This command is used to obtain information on errors that exist in the E5ZD. It can be used after a response for Measured Temperature Read indicates that an error exists or after a write command results in the end code 21, indicating that an error exists.

Command Format

The format for this command is as shown below. The unit number must be specified and the data code must be 03.

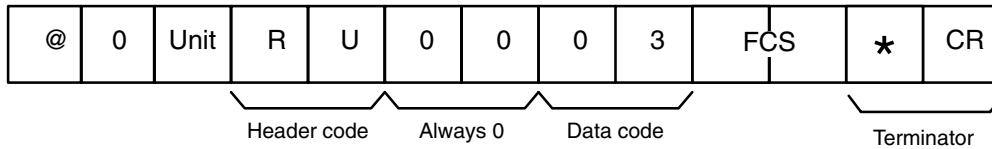

Command Examples

The following command is used to read the error status of Unit 2.

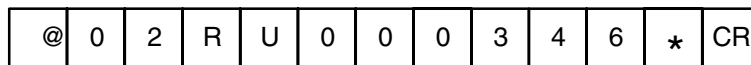

Response Format

The response returned for this command is shown below. This response assumes that the header code in the command block was transmitted and read normally and that the end code is 00. If the end code is not 00, the error status will not have been read and the end code will be followed immediately by the FCS. If the header code in the command block was not recognizable, a header code of IC will be returned without an end code (see Section 4-1-2 End Codes for the IC header code response format).

Any of the bits assigned to a flag indicate that an error exists when it is ON. The meanings of the various flags are described in the table below.

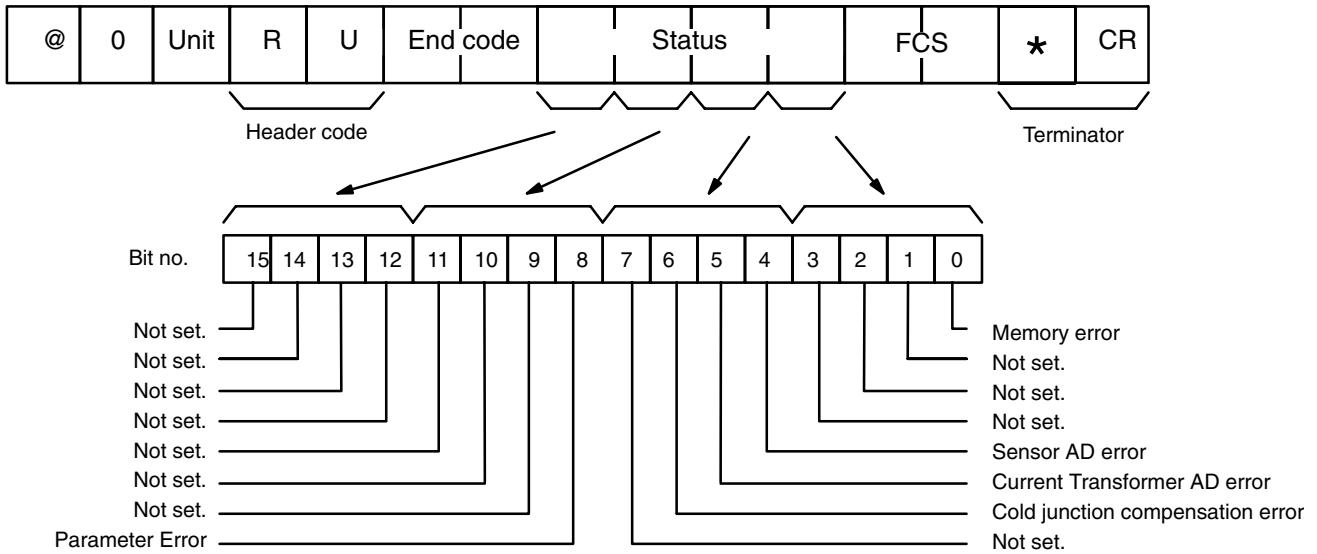

Bit status: 1: error; 0: normal

Name	Meaning
Memory Error flag	This error occurs when the contents of the memory have been destroyed, the CPU goes out of control, or when power is turned off before the response is received to the EEPROM Write command. Turn the E5ZD off and then on again. If recovery is not possible by initializing both RAM (with the Initialize Parameters command), and then EEPROM (with the EEPROM Write command), E5ZD calibrations may have been destroyed.
Sensor AD Error flag	The sensor AD converter circuitry may have failed. Turn the E5ZD off and on.
Current Transformer AD Error flag	The Current Transformer AD converter circuitry may have failed. Turn E5ZD power off and on.
Cold Junction Compensation Error flag	This error is generated when CN3 has been disconnected or the ambient temperature of the E5ZD has dropped below -15°C or exceeded 60°C. For the E5ZD-8□□KJ-E it is generated when CN903 is not connected correctly, and for the E5ZD-8H□KJM-E it is generated when the two terminal blocks for thermocouple input are disconnected.
Parameter Error flag	This error is generated when parameters in memory have been destroyed or parameters that do not agree with switch settings have been written into memory. Reinitialize memory with the Initialize Parameters command. The error may also be generated if °C is changed to °F or vice versa.

Response Examples

This response shows a memory error for Unit 0.

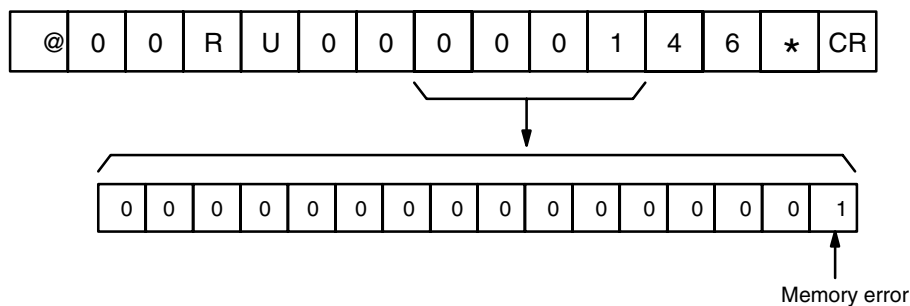

End Codes

If an end code of 00 was returned in the response, the command was executed normally. If the end code is not 00, the desired data will not have been read. Re-

fer to Section 4-1-2 End Codes for a description of the other possible end codes and their meanings.

4-2-26 Alarm Point Write: WU

This command can be used on models equipped with the HB and HS alarm function (E5ZD-□H□□□-E). It is used to designate the control points that are to have HB and HS alarms. It is necessary to execute this command for the alarms to be enabled because the alarms are turned OFF at the factory for all control points.

Note Alarm Point Write cannot be used if any of the control points is being autotuned or is otherwise operating, regardless of whether or not the setting for that control point is being changed.

Command Format

The format for this command is as shown below. The number of the Unit whose points are to be set must be specified and the data code must be 02. Each of bits 0 through 7 of the setting data is assigned to a control point as shown below. If the bit for a control point is OFF (0), the HB and HS alarms are turned OFF (the default). If the bit is ON (1), the HB and HS alarms are turned ON. The leftmost bits must be set to 0. If they are not, an error and an end code of 15 will be generated. For the E5ZD-4□□□-E, bits 4 to 7 must be set to 0. For the E5ZD-6□□□-E bits 6 to 7 must be set to 0. All bits are set to 0 at the factory.

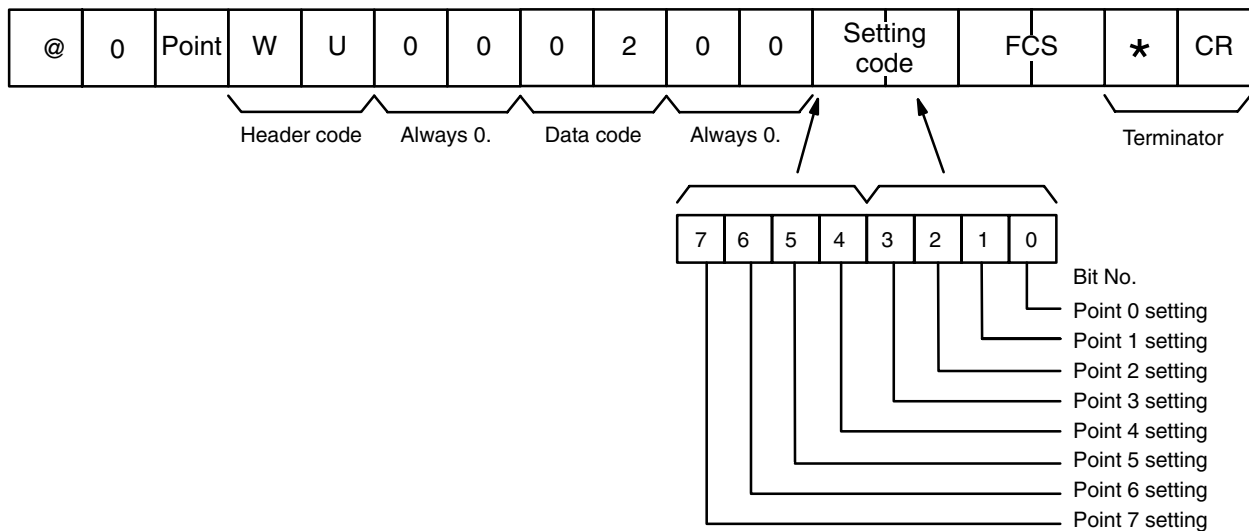

To determine the value to be input for the setting, convert the bits to two-digit hexadecimal values, treat each character as ASCII, and convert them independently to the hexadecimal equivalent of the ASCII code. For example, the value to set HB and HS alarms for control points 0 through 2 and cancel the HB and HS alarms for the remaining control points of a 6-point E5ZD would be 07_{hex}. A 0 in ASCII converts to hexadecimal 30, and a 7 converts to 37. The two digits of the setting would thus be 30_{hex}, 37_{hex}.

Command Examples

The following command is used to set HB and HS alarms for points 0, 2, and 4 of Unit 2, and to cancel the alarms for points 1, 3, and 5.

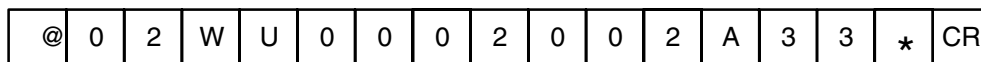

Response Format

The response returned for this command is shown below. This response assumes that the header code in the command block was transmitted and read normally. If the header code in the command block was not recognizable, a header code of IC will be returned without an end code (see Section 4-1-2 End Codes for the IC header code response format).

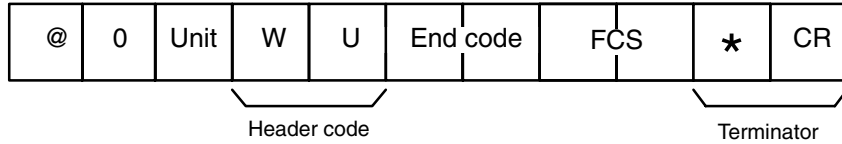

End Codes

If an end code of 00 was returned in the response, the command was executed normally. If the end code is not 00, the desired data will not have been written. Refer to Section 4-1-2 End Codes for a description of the other possible end codes and their meanings.

4-2-27 Alarm Point Read: RU

This command is used to read which control points have been set for HS and HB alarms. (The alarm functions are only available on models equipped with the heater burnout detection function (model numbers E5ZD-□H□-E). All alarms are factory preset to OFF and must be programmed by the operator to establish the desired operating conditions.)

Command Format

The format for this command is as shown below. The unit number must be specified and the data code must be 02.

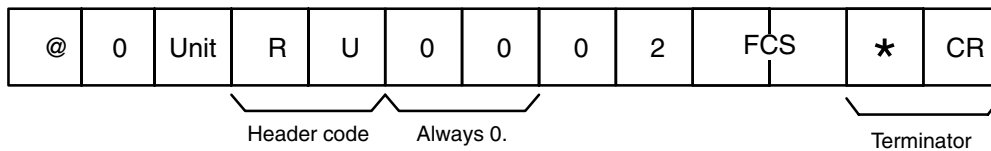

Command Examples

The following command is used to determine which control points are set for HB and HS alarms for Unit 2.

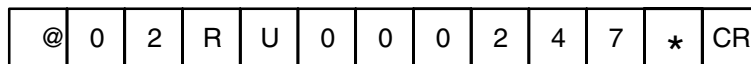

Response Format

The response returned for this command is shown below. This response assumes that the header code in the command block was transmitted and read normally and that the end code is 00. If an end code other than 00 is returned, the desired data will not have been read and the end code will be followed immediately by the FCS. If the header code in the command block was not recogniz-

able, a header code of IC will be returned without an end code (see Section 4-1-2 End Codes for the IC header code response format).

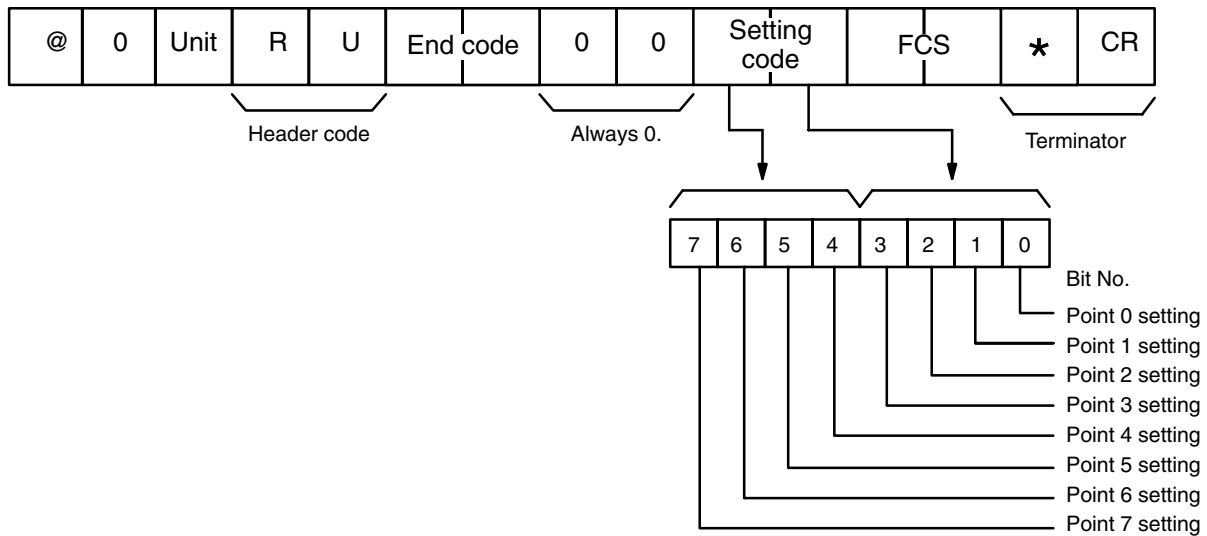

Bit status, meaning, and conversion methods are the same as those used to set the HB and HS alarm points. Refer to *Alarm Point Write* for details.

Response Examples

This response shows that HB and HS alarms on Unit 2 have been set for control points 0, 2, and 4 and canceled for control points 1, 3, and 5.

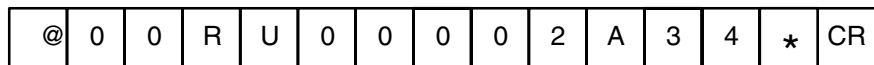

End Codes

If an end code of 00 was returned in the response, the command was executed normally. If the end code is not 00, the desired data will not have been read. An end code of 01 will be generated if this command is executed for a model without the heater burnout detection function. Refer to Section 4-1-2 End Codes for a description of the other possible end codes and their meanings.

4-2-28 Detection Level Write: WW

This command is used to set the current value that will trigger the HB alarm. The trigger current level for all alarms is set to 0.0 A for all control points (canceling the HB alarm) at the factory and needs to be reset in order for the alarms to operate. (The alarm functions are only available on models equipped with the heater burnout detection function (model numbers E5ZD-□H-E).

The current value set with Detection Level Write is compared with the current from the Current Transformer for the heater. If the current from the Current Transformer falls below the value set for the detection current level, and HB alarm output switch ON until the current level again rises to the detection level. When the detection level is exceeded again, the HB alarm output will turn OFF.

If the detection level is set to 0.0, the HB alarm output will not operate. This will not affect the operation of the HS alarm. (The HS alarm output will turn ON if the Current Transformer current is 0.5 A or greater when the control output is OFF.) If the detection level is set to 0.0 when the HB alarm output is ON, the HB alarm output will go OFF.

Command Format

The format for this command is as shown below. The unit number and control point must be specified along with the desired trigger level. The detection level is specified in three digits to units of one-tenth of an amp.

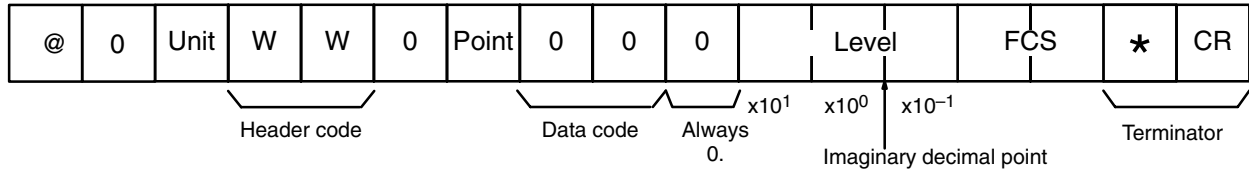

Command Examples

The following command is used to set a detection level of 25 A for control point 0 of Unit 0.

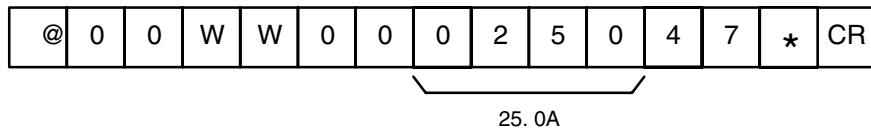

Response Format

The response returned for this command is shown below. This response assumes that the header code in the command block was transmitted and read normally. If the header code in the command block was not recognizable, a header code of IC will be returned without an end code (see Section 4-1-2 End Codes for the IC header code response format).

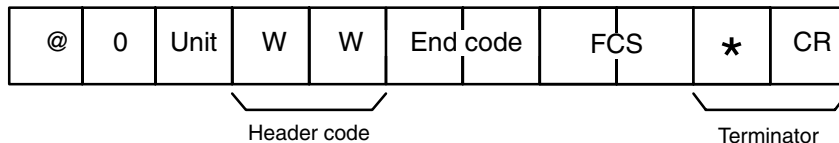

End Codes

If an end code of 00 was returned in the response, the command was executed normally. If the end code is not 00, the desired data will not have been written. Refer to Section 4-1-2 End Codes for a description of the other possible end codes and their meanings.

4-2-29 Detection Level Read: RW

This command is used to read the current level set for activation of the HB alarm. The current level for all alarms is factory preset to 0.0 A for all control points (canceling the HB alarm), and needs to be programmed by the operator to ensure correct operation. (The alarm functions are only available on models equipped with the heater burnout detection function (model numbers E5ZD-□H□-E).

Command Format

The format for this command is as shown below. The unit number and control point must be specified.

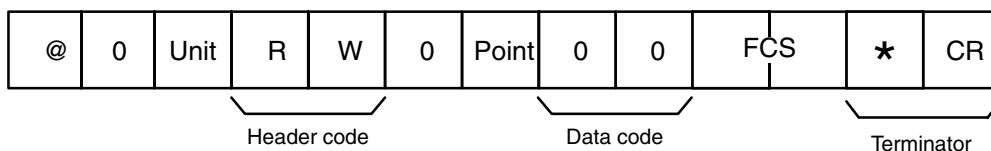

Command Examples

The following command is used to read the detection level setting for control point 0 of Unit 2.

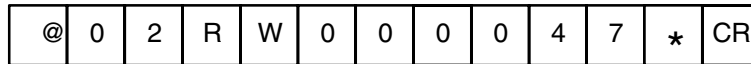

Response Format

The response returned for this command is shown below. This response assumes that the header code in the command block was transmitted and read normally and that the end code is 00. If the end code is not 00, the desired data will not have been read and the end code will be followed immediately by the FCS. If the header code in the command block was not recognizable, a header code of IC will be returned without an end code (see Section 4-1-2 End Codes for the IC header code response format).

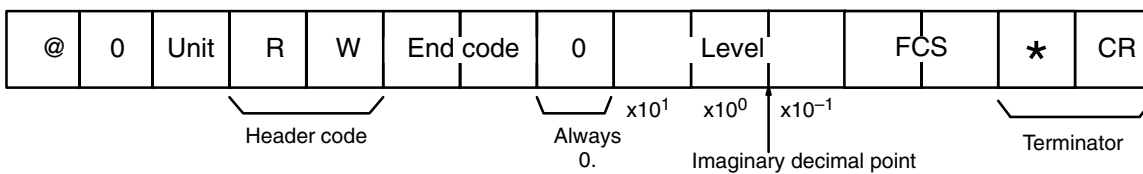

Response Examples

This response shows that a detection level of 30.0 A has been set for control point 0 of Unit 2.

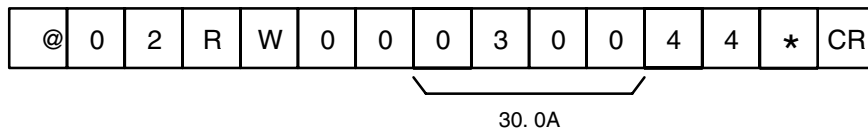

End Codes

If an end code of 00 was returned in the response, the command was executed normally. If the end code is not 00, the desired data will not have been read. Refer to Section 4-1-2 End Codes for a description of the other possible end codes and their meanings.

4-2-30 Heater Current Read: RZ

This command is used to measure the current being supplied to the heater. (The alarm functions are only available on models equipped with the heater burnout detection function (model numbers E5ZD-□H□-E). When the points set have been activated for HB and HS alarms by WU, or when control is stopped for those points, 0000 will be returned as data.

Command Format

The format for this command is as shown below. The unit number and control point must be specified.

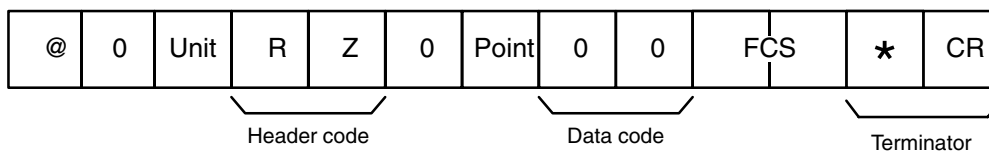

Command Examples

The following command is used to measure the current being supplied to the heater for control point 1 of Unit 1.

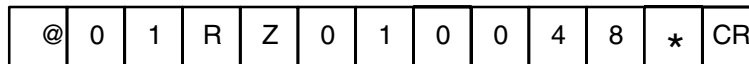

Response Format

The response returned for this command is shown below. This response assumes that the header code in the command block was transmitted and read normally and that the end code is 00. If the end code is not 00, the measured current will not have been returned and the end code will be followed by the error code (see below). If the header code in the command block was not recognizable, a header code of IC will be returned without an end code (see Section 4-1-2 End Codes for the IC header code response format).

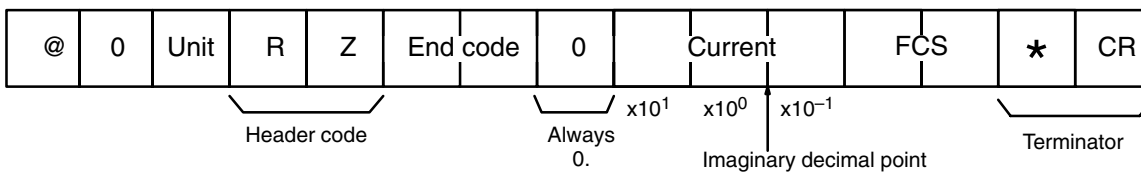

Response Examples

This response shows that 25.6 A are being supplied to the heater for control point 1 of Unit 1.

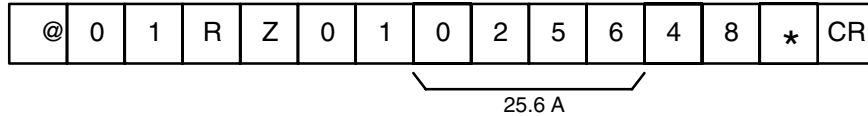

Error Codes

If an error has occurred that makes measuring current impossible, Heater Current Read will result in a response that contains an error code that indicates the type of error that has occurred. The response format is shown below, and the subsequent table describes the error codes.

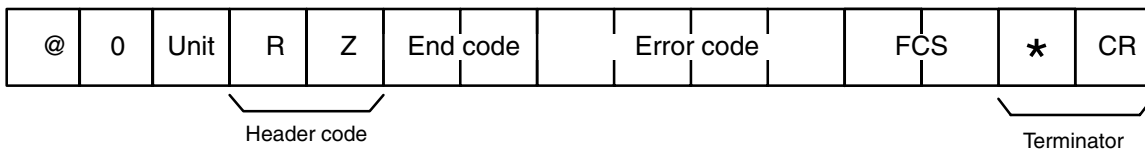

Error code	Name	Meaning
E004	CT A/D error	The Current Transformer A/D converter has failed. Turn the E5ZD off and on to reset.
E022	Heater overflow error	The measured heater current has exceeded 55 A.

End Codes

If an end code of 00 was returned in the response, the command was executed normally. If the end code is not 00, the desired data will be read. Refer to Section 4-1-2 End Codes for a description of the other possible end codes and their meanings.

4-3 Fuzzy Constant Commands (Fuzzy-logic Controllers Only)

This section describes the commands that are used to read and write fuzzy constants.

4-3-1 Fuzzy Constant Write Commands

This section covers the commands that are used to set fuzzy constants: the fuzzy strength, fuzzy scale 1, and fuzzy scale 2.

Command Formats

Designate the point and memory bank to set the fuzzy constant. Fuzzy strength cannot be set automatically. Autotuning PID constants automatically sets the values of fuzzy scales 1 and 2. If the PID constants have been manually set, the values of fuzzy scales 1 and 2 automatically changes according to the PID constants. It is possible to change the values of fuzzy scales 1 and 2 manually after the PID constants are set.

The header code varies with the fuzzy constant to be set. These commands cannot be used while autotuning is being executed.

Fuzzy Strength Write: Wj

Designate a fuzzy strength value between 0000 and 0099 in increments of 1%. If 0000 is designate, the Temperature Controller will control the temperature using only PID with feed-forward circuitry.

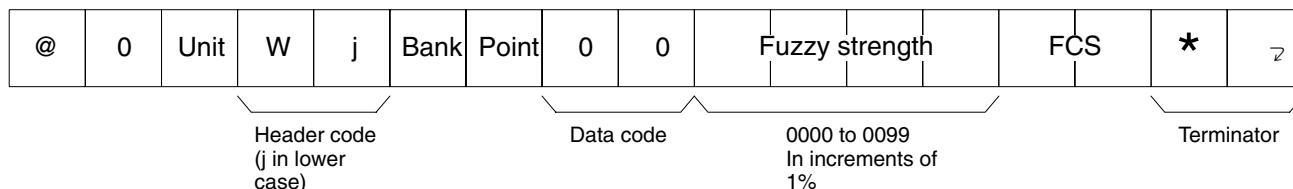

Fuzzy Scale 1 Write: Wk

Designate a fuzzy scale 1 value between 0002 and 9999 in increments of 0.1°C or 0.1°F.

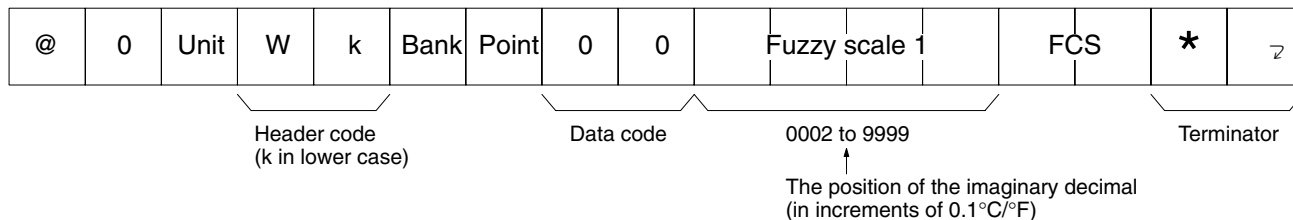

Fuzzy Scale 2 Write: WI

Designate a fuzzy scale 2 value between 0020 and 9999 in increments of 0.01°C/s or 0.01°F/s.

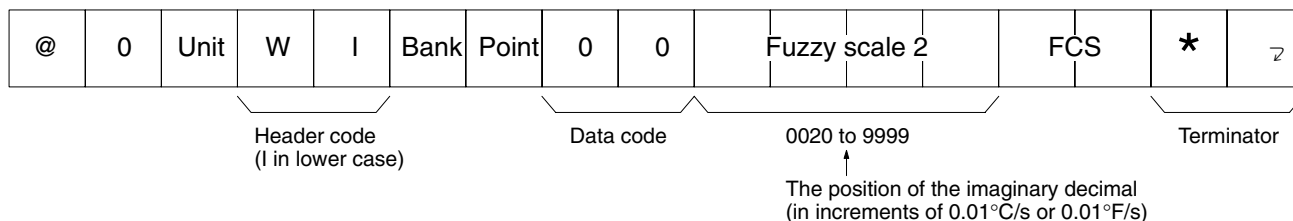

Command Example

The following command is used to set the Temperature Controller to a fuzzy strength of 25% in memory bank 3 of point 2 in unit 1.

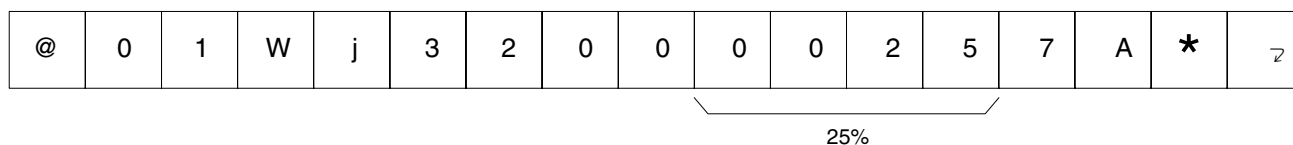

Take the decimal position into consideration when writing the fuzzy scale 1 value (increments of 0.1), and when writing the fuzzy scale 2 value (increments of 0.01).

Response Format

The response returned for this command is shown below. This response assumes that the header code in the command block was transmitted and read normally. If the header code in the command block was not recognizable, a header code of IC will be returned without an end code (see Section 4-1-2 End Codes for the IC header code response format).

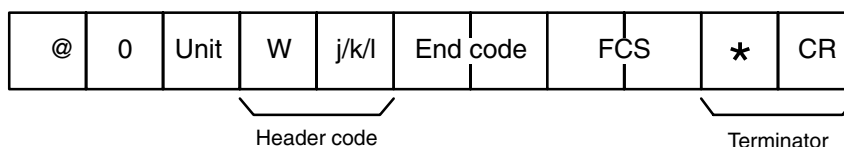

End Codes

If an end code of 00 was returned in the response, the command was executed normally. If the end code is not 00, the desired data will not have been written. Refer to Section 4-1-2 End Codes for a description of the other possible end codes and their meanings.

4-3-2 Fuzzy Constant Read Commands

This section covers the commands that are used to read fuzzy constants: fuzzy strength, fuzzy scale 1, and fuzzy scale 2. The value of fuzzy scale 1 is returned to the nearest 0.1°C. The value of fuzzy scale 2 is returned to the nearest 0.01°C. Designate the point and memory bank to read the fuzzy constant. The header code varies with the fuzzy constant to be read.

Command Formats

Fuzzy Strength Read: Rj Fuzzy strength is returned between 0000 and 0099 with increments of 1%.

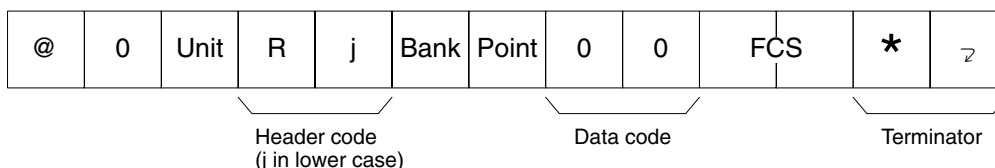

Fuzzy Scale 1 Read: Rk Fuzzy scale 1 is returned between 0002 and 9999 in increments of 0.1°C or 0.1°F.

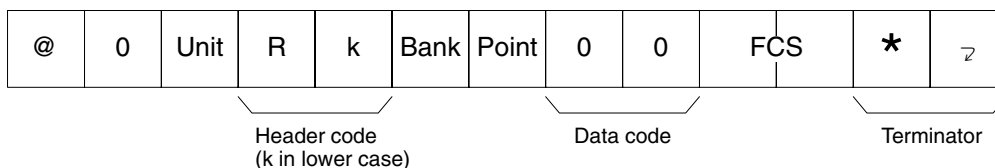

Fuzzy Scale 2 Read: RI Fuzzy scale 2 is returned between 0020 to 9999 in increments of 0.01°C/s or 0.01°F/s.

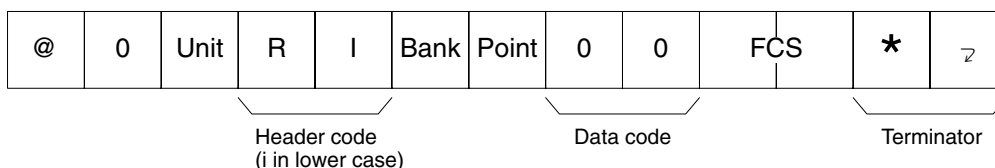

Command Example

The following command is used to read the fuzzy strength from memory bank 3 of point 2 in unit 1.

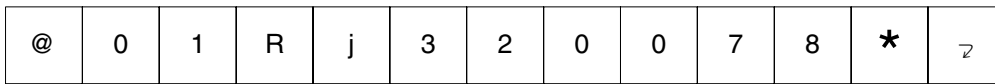

Response Formats

When the host computer sends an Rj, Rk, or RI command, the Temperature Controller respond according to the command. The responses returned for these commands are shown below.

The following response will be returned when the header code has been read.

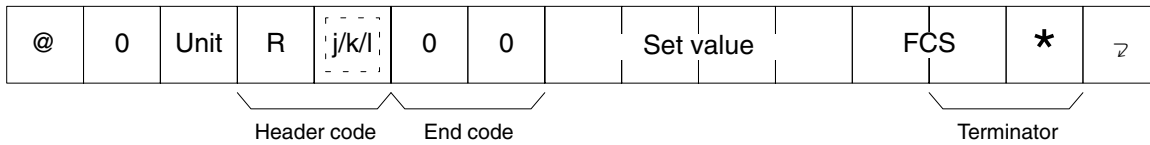

End Codes

If an end code of 00 was returned in the response, the command was executed normally. If the end code is not 00, the desired data will not have been read. Refer to *Section 4-1-2 End Codes* for a description of the other possible end codes and their meanings.

4-4 Global Read and Control Operations

The memory bank, control point, and data code designations can be specially defined to allow certain commands to be globally applied. Such commands can be used to control the operation of, or read out data for, all control points, all memory banks for a specified control point, or all data codes with the same header code. The commands for global read and global control operations are listed in the table at the end of this section.

Command Format

The format for this command is as shown below. The unit number, header code, memory bank, control point, and data code must be identified with a special designation which specifies the group to be acted on, i.e., memory banks, control points, or data codes.

If “A” is used for the control point, all of the control points for the specified Unit are specified; if “A” is used for the memory bank, all of the memory banks for the specified control point are specified; if “AA” is used for the data code, all possible data codes with the specified header code are specified.

Only one of these special designations may be specified at any time. In addition “A” cannot be specified for the memory bank at the same time as “AA” is specified for the data code.

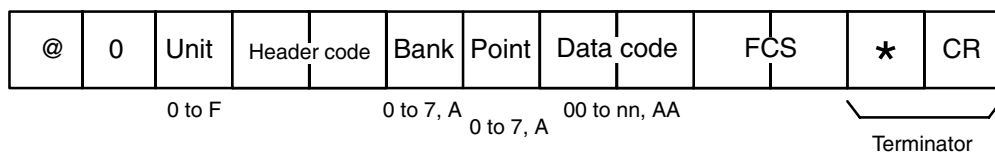

Response Formats

The response returned for a global read or control command depends on which special designation is used. The three possible formats are shown below. These responses assume that the header code in the command block was transmitted and read normally and that the end code is 00. If the end code is not 00, the desired data will not have been read and the end code will be followed immediately by the FCS. If the header code in the command block was not recognizable, a header code of IC will be returned without an end code (see *Section 4-1-2 End Codes* for the IC header code response format).

Designations in parentheses are for 6-point E5ZD models.

"A" Designations for the Control Point (n: number of control points-1)

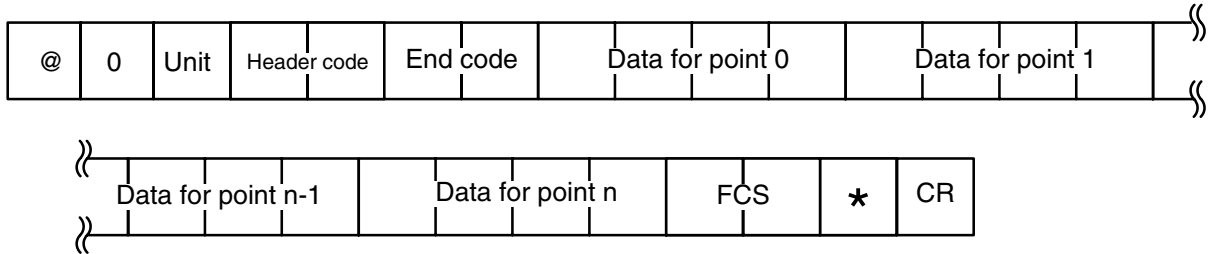

"A" Designations for the Memory Bank

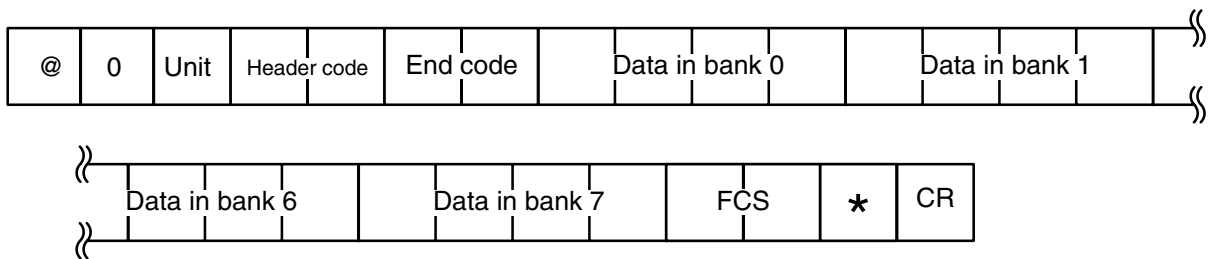

"AA" Designations for the Data Code

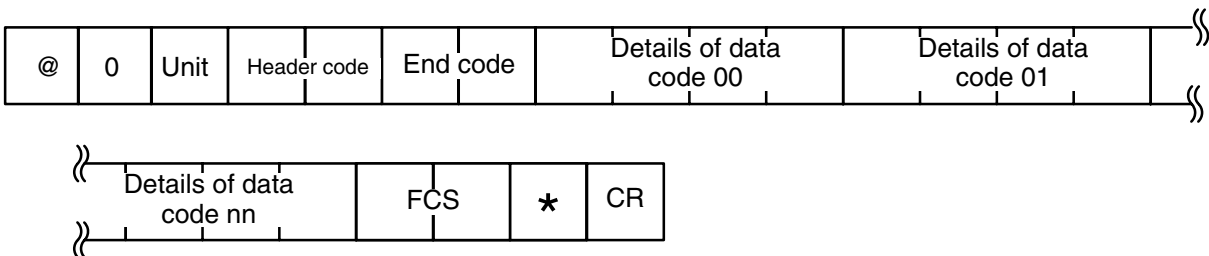

Global Read and Control Operations

Control point numbers are listed for 8-point models.

Header Code	Memory Bank	Point	Data Code	Operation
OP	0	0 to 7	00	Stops specified point.
		A		Stops all points.
OS	0	0 to 7	00	Starts specified point.
		A		Starts all points.

Header Code	Memory Bank	Point	Data Code	Operation
AS	0	0 to 7	00	Starts autotuning for specified point.
		A	00	Starts autotuning for all points simultaneously.
			01	Starts autotuning for all points sequentially.
R#	0	0 to 7	00	Reads modes for alarm 1 as specified.
			01	Reads modes for alarm 2 as specified.
			AA	Reads modes for alarms 1 and 2 as specified.
		A	00	Reads modes for alarm 1 for all points.
			01	Reads modes for alarm 2 for all points.
R%	0 to 7	0 to 7	00	Reads alarm 1 temperature as specified.
			01	Reads alarm 2 temperature as specified.
			AA	Reads alarm 1 and 2 temperatures as specified.
		A	00	Reads alarm 1 temperatures for all points.
			01	Reads alarm 2 temperatures for all points.
	A	0 to 7	00	Reads alarm 1 temperatures for all banks.
			01	Reads alarm 2 temperatures for all banks.
RB	0 to 7	0 to 7	00	Reads proportional band as specified.
		A	00	Reads proportional bands for all points.
	A	0 to 7	00	Reads proportional bands for all banks.
RH	0 to 7	0 to 7	00	Reads hysteresis as specified.
		A	00	Reads adjustment sensitivities for all points.
	A	0 to 7	00	Reads adjustment sensitivities for all banks.
RI	0 to 7	0 to 7	00	Reads input shift as specified.
		A	00	Reads input shifts for all points.
	A	0 to 7	00	Reads input shifts for all banks.
RM	0	0 to 7	00	Reads memory bank designation as specified.
		A	00	Reads memory bank designations for all points.
RN	0 to 7	0 to 7	00	Reads integral time as specified.
		A	00	Reads integral times for all points.
	A	0 to 7	00	Reads integral times for all banks.
RO	0	0 to 7	00	Reads output percentage as specified.
		A	00	Reads output percentages for all points.
RS	0 to 7	0 to 7	00	Reads set temperature as specified.
		A	00	Reads set temperatures for all points.
	A	0 to 7	00	Reads set temperatures for all banks.
RT	0 to 7	0 to 7	00	Reads control periods as specified.
		A	00	Reads control periods for all points.
	A	0 to 7	00	Reads control periods for all banks.

Header Code	Memory Bank	Point	Data Code	Operation
RU	0	0	00	Reads output modes.
			01	Do not use (0000).
			02	Reads points set for HB and HS alarms.
			03	Reads error status.
			AA	Reads output modes, points set for HB and HS alarms, and error status.
RV	0 to 7	0 to 7	00	Reads derivative time as specified.
		A	00	Reads derivative times for all points.
	A	0 to 7	00	Reads derivative times for all banks.
RW	0	0 to 7	00	Reads heater burnout detection level as specified.
		A	00	Reads heater burnout detection level for all points.
RX	0	0 to 7	00	Reads measured temperature as specified.
			01	Reads output percentage as specified.
			02	Reads operating status as specified.
			AA	Reads measured temperature, output percentage, and operating status.
		A	00	Reads measured temperatures for all points.
			01	Reads output percentages for all points.
			02	Reads operating status for all points.
RZ	0	0 to 7	00	Reads heater current as specified.
		A	00	Reads heater currents for all points.
Rj	0 to 7	0 to 7	00	Reads fuzzy strength as specified.
		A	00	Reads fuzzy strength for all points.
Rk	0 to 7	0 to 7	00	Reads fuzzy scale 1 as specified.
		A	00	Reads fuzzy scale 1 for all points.
Rl	0 to 7	0 to 7	00	Reads fuzzy scale 2 as specified.
		A	00	Reads fuzzy scale 2 for all points.

4-5 Global Write Operations

Special designations can be used for the memory bank, control point, and data code designations to allow certain commands to write the same data into the same parameter for all control points, all memory banks for a specified control point, or/and all data codes with the same header code. The commands for global write operations are listed in the table at the end of this section.

Command Format

The format for this command is as shown below. The unit number, header code, memory bank, control point, and data code must be identified with a special designation specifies the groups to be acted on: i.e., memory bank, control point, and/or data code.

If "A" is used for the control point, all of the control points for the specified Unit are specified; if "A" is used for the memory bank, all of the memory banks for the specified control point are specified; if "AA" is used for the data code, all possible data codes with the specified header code are specified.

One, two, or all three of these special designations may be made at any time, depending on the header code (see table below).

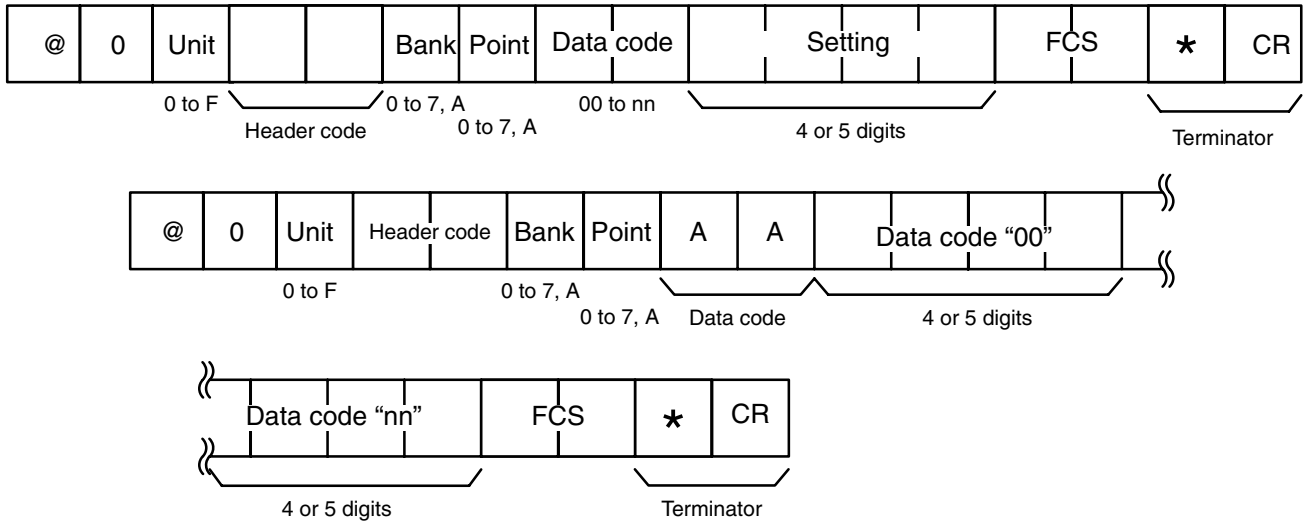

Response Formats

The responses returned for these commands are shown below. These responses assume that the header code in the command block was transmitted and read normally. If the header code in the command block was not recognizable, a header code of IC will be returned without an end code (see Section 4-1-2 End Codes for the IC header code response format).

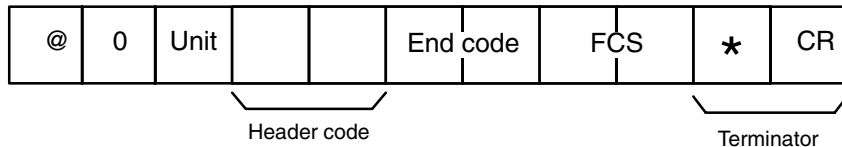

End Codes

If an end code of 00 was returned in the response, the command was executed normally. If the end code is not 00, the desired data will not have been written. Refer to Section 4-1-2 End Codes for a description of the other possible end codes and their meanings.

Global Write Operations

Control point numbers are listed for 8-point models.

Header Code	Memory Bank	Point	Data Code	Operation
W#	0	0 to 7	00	Writes alarm 1 mode as specified.
			01	Writes alarm 2 mode as specified.
			AA	Writes alarm 1 and 2 modes as specified.
		A	00	Writes alarm 1 modes for all points.
			01	Writes alarm 2 modes for all points.
			AA	Writes alarm 1 and 2 modes for all points.

Header Code	Memory Bank	Point	Data Code	Operation
W%	0 to 7	0 to 7	00	Writes alarm 1 temperature as specified.
			01	Writes alarm 2 temperature as specified.
			AA	Writes alarm 1 and 2 temperatures as specified.
		A	00	Writes alarm 1 temperatures for all points.
			01	Writes alarm 2 temperatures for all points.
			AA	Writes alarm 1 and 2 temperatures for all points.
	A	0 to 7	00	Writes alarm 1 temperatures for all banks.
			01	Writes alarm 2 temperatures for all banks.
			AA	Writes alarm 1 and 2 temperatures for all banks.
		A	00	Writes alarm 1 temperatures for all banks and points.
			01	Writes alarm 2 temperatures for all banks and points.
			AA	Writes alarm 1 and 2 temperatures for all banks and points.
WB	0 to 7	0 to 7	00	Writes proportional band as specified.
		A	00	Writes proportional bands for all points.
	A	0 to 7	00	Writes proportional bands for all banks.
		A	00	Writes proportional bands for all banks and points.
WH	0 to 7	0 to 7	00	Writes hysteresis as specified.
		A	00	Writes adjustment sensitivities for all points.
	A	0 to 7	00	Writes adjustment sensitivities for all banks.
		A	00	Writes adjustment sensitivities for all banks and points.
WI	0 to 7	0 to 7	00	Writes input shift as specified.
		A	00	Writes input shifts for all points.
	A	0 to 7	00	Writes input shifts for all banks.
		A	00	Writes input shifts for all banks and points.
WM	0 to 7	0 to 7	00	Writes memory bank designation as specified.
		A	00	Writes memory bank designations for all points.
WN	0 to 7	0 to 7	00	Writes integral time as specified.
		A	00	Writes integral times for all points.
	A	0 to 7	00	Writes integral times for all banks.
		A	00	Writes integral times for all banks and points.
WS	0 to 7	0 to 7	00	Writes set temperature as specified.
		A	00	Writes set temperatures for all points.
	A	0 to 7	00	Writes set temperatures for all banks.
		A	00	Writes set temperatures for all banks and points.
WT	0 to 7	0 to 7	00	Writes control period as specified.
		A	00	Writes control periods for all points.
	A	0 to 7	00	Writes control periods for all banks.
		A	00	Writes control periods for all banks and points.
WU	0	0	00	Writes output modes as specified.
			01	Do not use (0000)
			02	Writes HB and HS alarm points as specified.
			AA	Writes output modes and HB and HS alarm points as specified.

Header Code	Memory Bank	Point	Data Code	Operation
WV	0 to 7	0 to 7	00	Writes derivative time as specified.
		A	00	Writes derivative times for all points.
	A	0 to 7	00	Writes derivative times for all banks.
		A	00	Writes derivative times for all banks and points.
WW	0	0 to 7	00	Writes heater burnout detection level as specified.
		A	00	Writes heater burnout detection level for all points.
Wj	0 to 7	0 to 7	00	Writes fuzzy strength as specified.
		A	00	Writes fuzzy strength for all points.
Wk	0 to 7	0 to 7	00	Writes fuzzy scale 1 as specified.
		A	00	Writes fuzzy scale 1 for all points.
Wl	0 to 7	0 to 7	00	Writes fuzzy scale 2 as specified.
		A	00	Writes fuzzy scale 2 for all points.

SECTION 5

Transmission Times

This section describes how to calculation the transmission times for reading and writing data. These times depend on the baud rate and the processing speed of the E5ZD.

5-1	Writing Times	120
5-2	Reading Times	120

5-1 Writing Times

The time required from start of a transmission for a write operation to the point where the data being written will affect operation is given below. Internal processing (the time required from reception of an command by the E5ZD to the start of its response transmission) requires, for all commands but EEPROM Write, a maximum of 130 ms + 20 ms × the number of data items for Fuzzy-logic Controllers and 50 ms for other Controllers. EEPROM Write can require up to a maximum of 3.5 seconds for internal processing for Fuzzy-logic Controllers; 2.3 seconds for other Controllers.

$$\text{Time} = \frac{\text{Number of characters being sent} \times 11 \text{ bits per character}}{\text{baud rate}} + \text{internal processing time} \\ + 500 \text{ ms of arithmetic cycle time}$$

For example, suppose we send the following command to write a set temperature of 100°C in memory bank 0 for control point 0 of unit 0 at a baud rate of 9,600 bps.

Each character consists of 11 bits (i.e., 1 start bit, 7 data bits, 1 parity bit, and 2 stop bits).

@ 0 0 W S 0 0 0 0 0 1 0 0 FCS * CR

The transmission includes a total of 17 characters (FCS would be two; CR, one). Placing 17 into the above equation produces the following:

$$\frac{17 \text{ characters} \times 11 \text{ bits per character}}{9.6 \text{ bits}} \approx 20 \text{ ms}$$

$$\text{Fuzzy-logic Controllers: } 20 \text{ ms} + (130 \text{ ms} + 20 \text{ ms}) + 500 \text{ ms} = 670 \text{ ms}$$

$$\text{Other Controllers: } 20 \text{ ms} + 50 \text{ ms} + 500 \text{ ms} = 570 \text{ ms}$$

The new set temperature would thus come into use approximately 670 ms or 570 ms after the host computer began transmission of the command.

A minimum of 10 ms is required between receiving a response and sending the next command.

5-2 Reading Times

The time required from start of a transmission for a read operation to the point where the data being read is returned to the host computer is given below. Internal processing (the time required from reception of an command by the E5ZD to the start of its response transmission) required, for all read commands, a maximum of 150 ms for Fuzzy-logic Controllers and 50 ms for other Controllers.

$$\text{Time} = \text{internal processing time} \\ + 500 \text{ ms of arithmetic cycle time} + \frac{\text{Number of characters being returned} \times 11 \text{ bits per character}}{\text{baud rate}}$$

For example, suppose we send the following command to read the measured temperature for control point 0 of Unit 0 at a baud rate of 9,600 bps and the E5ZD returns the response shown.

Each character consists of 11 bits (i.e. 1 start bit, 7 data bits, 1 parity bit, and 2 stop bits).

Command: @ 0 0 R X 0 0 0 0 FCS * CR
 Response: @ 0 0 R X 0 0 0 1 0 0 FCS * CR

The command includes a total of 13 characters (FCS would be two; CR, one) and the response includes 15. Placing 13 and 15 into the above equation produces the following:

$$\begin{aligned} & (13 \text{ characters} \times 11 \text{ bits/character})/9.6 \text{ bits/ms} + 50 \text{ ms} + 500 \text{ ms} = \\ & 570 \text{ ms (approximate)} + (15 \text{ characters} \times 11 \text{ bits/character})/9.6 \text{ bits/ms} \\ & = 13 \times 11/9.6 + 50 + 500 + 15 \times 11/9.6 \text{ ms} \\ & = 583 \text{ ms (approximate)} \end{aligned}$$

Command:

$$\frac{13 \text{ characters} \times 11 \text{ bits per character}}{9.6 \text{ bits}} \approx 15 \text{ ms}$$

Response:

$$\frac{15 \text{ characters} \times 11 \text{ bits per character}}{9.6 \text{ bits}} \approx 18 \text{ ms}$$

Fuzzy-logic Controllers: $150 \text{ ms} + 500 \text{ ms} + 18 \text{ ms} = 668 \text{ ms}$

Other Controllers: $50 \text{ ms} + 500 \text{ ms} + 18 \text{ ms} = 568 \text{ ms}$

The measured temperature would thus be returned to the host computer a maximum of 683 ms (15 ms + 668 ms) or 583 ms (15 ms + 568 ms) after the host computer started transmitting the read command. The measured temperature that was returned would be the one that was current 668 ms or 568 ms before the response was received.

SECTION 6

Troubleshooting

This section provides lists of possible causes and solutions for several common problems and describes the loop-back test used to check E5ZD communications.

6-1	Troubleshooting Lists	124
6-2	Loop-Back Communications Test	128

6-1 Troubleshooting Lists

The following lists provide likely causes and solutions to common problems. Relevant sections of this manual are given as reference.

Communications Not Possible

The communications indicator on the E5ZD can be used to see if the E5ZD is transmitting. The following are the probable causes of communications problems.

Possible cause	Remedy	Reference
Communications connector wired incorrectly	Wire correctly	Sec. 2-1-4
Communications connector loose	Tighten the connector screws	Sec. 2-1-4
Power supply is not connected or voltage is incorrect	Ensure that the correct power supply is connected to the power connector.	Sec. 1-4-3, 2-1-1
Power supply polarity is wrong	Wire correctly	Sec. 1-4-3, 2-1-1
E5ZD and host computer baud rates differ	Set to same rate	Sec. 1-4-3, 2-1-1
Communications format differs	Set host computer to E5ZD format. Check errors at E5ZD monitor indicator. Check reception with loop-back text.	Page 18 RS-232C IF
Unit number in command wrong	Use the correct unit number (as set on E5ZD)	Sec. 2-1-5
Same unit number assigned twice on same transmission path.	Ensure that different numbers are assigned to all Units that communicate with the same host computer	Sec. 2-1-5
Mode is set for test communications.	Turn DIP switch setting to Normal Mode	Sec. 2-1-5
Host computer program incorrect	Debug program	Sec. 4-1
Host starts next transmission before receiving response	Delay transmission until response is confirmed	Section 5
False or erroneous signals received at the host computer due to instability when switching the E5ZD ON and OFF	Clear host computer reception buffer before beginning transmission and after turning off E5ZD	Sec. 4-2-25
There is an error on the E5ZD	Read E5ZD error status and rectify error	Sec. 4-1-2, 4-2-25
There is insufficient time between the time the response is received and the time the next instruction is transmitted.	Leave a space of at least 10 ms before the next instruction is transmitted.	Sec. 1-4-3
There is a communications data error due to environmental noise.	Use shielded cable. Use optical interface. Slow down transmission speed and try again. Move communications cable away from the source of noise.	Sec. 3-2-3
For RS-422, a Link Adapter is being used incorrectly.	Check wiring with the Link Adapter manual.	Page 20 RS-422 IF

Outputs Don't Turn ON The output indicators on the E5ZD can be used to see when outputs turn ON. The following are the probable causes of output problems.

Possible cause	Remedy	Reference
No external power supplied to open-collector outputs.	Wire correctly.	Page 42 Control Outputs
The voltage is falling when the output is ON, because the output current exceeds the rating.	To avoid internal damage, reduce current to within specification range.	App. A
Power supply polarity is reversed.	Wire correctly.	Sec. 1-4-1
Pin numbers are incorrect.	Wire correctly.	Page 45 Table for pin alloca- tion
Internal circuitry damaged because a relay was connected with no diode to the output.	Repairs to E5ZD are required.	Page 42 Control Outputs
Excessive current flowing to alarm output due to faulty wiring.	Alarm outputs have no protective circuits, so care is required when connecting them. If there has been internal damage, repairs are required.	Sec. 1-4-1
Memory bank designation is incorrect.	Correct the designation. When contact inputs are designated, the same memory banks are valid for all points. Check whether inputs are continued at time of contact input designation. Inputs must be continued during designation.	Sec. 1-4-1, 3-3
Point designation is incorrect.	Make correct designation. Begin from point No. 0.	Sec. 4-2-1
Control not starting.	Begin control.	Sec. 4-2-6
Sensor disconnected or short-circuited.	Replace sensor.	Sec. 4-2-9
Controlled temperature setting is incorrect.	Correct the setting.	Sec. 4-2-2
Switches set to halt operation after power interruptions.	Restart operation or change switch setting.	Sec. 2-1-5
Control is executed with the wrong memory bank.	Correct the host program.	Sec. 3-3
Power not supplied to I/O Relay Terminal.	Provide the specified fixed power supply.	Sec. 2-3-6
G79-□□□ is not being used for connecting with I/O Relay Terminal.	Use the specified cable.	Sec. 2-3-1, 2-3-2
Attempt is being made to designate memory bank with communications, but setting is for designation by contact inputs.	Correct the setting with the DIP switch.	Sec. 3-3
Attempt is being made to designate memory bank with contact inputs, but setting is for designation by communications.	Correct the setting with the DIP switch.	Sec. 3-3

Temperature Measured by Sensor in Error

Possible cause	Remedy	Reference
Sensor polarity or wiring is wrong	Wire correctly	Sec. 3-5
Sensor type is wrong	Use correct sensor	Sec. 1-3-1
Sensor type switch setting is wrong	Set DIP switch correctly	Sec. 2-1-5
A sensor is connected which cannot be used with the E5ZD.	Use sensors that are compatible with the E5ZD, and set the DIP switch.	Sec. 1-4-2
Thermocouple is used without compensation lead	Connect compensation lead	Sec. 1-4, and Page 17 Terminal Blocks
Compensation lead doesn't match the thermocouple	Use correct compensation lead	Sec. 1-4, and Page 17 Terminal Blocks
Something other than the thermocouple or compensation lead is connecting the thermocouple and terminal block.	Use proper thermocouple connection	Sec. 1-4, and Page 17 Terminal Blocks
Terminal block screws loose	Tighten screws	Page 17 Terminal Blocks
The shorting pin is missing from between pins 1 and 2 of CN3	Short pins 1 and 2 together when using thermocouple	Page 11 Connectors
Sensor wiring is broken or shorted	Replace sensor	Sec. 3-5
The special terminal blocks are not being used for E5ZD-8H□KJM-E thermocouple inputs.	Use an E54-TR011 terminal block.	Sec. 2-3-1
The special terminal blocks are not being used for E5ZD-8H□PM-E platinum resistance thermometer inputs.	E54-TR011 terminal blocks cannot be used. Use through-type terminal blocks instead.	Sec. 2-3-2
A sensor terminal has been left unconnected	Connect dummy inputs to all unused sensor terminals	Sec. 2-1-4
Noise or inductance is affecting signal	Separate the sensor wiring from load and/or power supply lines	Sec. 1-4-2, 3-2-3
Terminal block temperature varies or is too high	Install a block that will not get too hot or be subject to excessive temperature variations	Sec. 1-4-2
Measured temperature is out-of-range	Use sensor of appropriate range or ensure that the temperature is maintained to within the chosen range	Sec. 1-3-1
Input shift is wrong	Reset input shift value	Sec. 4-2-19
Celsius-Fahrenheit designation is wrong	Set switch correctly	Sec. 2-3-10
Setting values are incorrect, e.g., decimal points are wrong, etc.	Input correct values	Section 4
Host computer program is wrong	Debug program	Section 4

Heater Burnout Detection Doesn't Work Properly

Possible cause	Remedy	Reference
Current Transformer is not connected properly.	Correctly wire Current Transformer.	Sec. 3-5
E54-CT2 is being used.	Only E54-CT1 and E54-CT3 can be used as Current Transformers.	Sec. 1-4-3, App. A
HB and HS alarms have not been made operational.	Use Alarm Point Write (WU) to make alarms operational.	Sec. 4-2-7
Setting for heater burnout detection level is 0.0 A.	With a setting of 0.0 A the HB alarm is invalid. Make the proper setting.	Sec. 4-2-28
Setting for heater burnout detection level is incorrect.	Take into account variations in measurement and fluctuations in heater power supply voltage. Allow for a 1 A fluctuation due to ambient temperature influences.	Sec. 1-4-3, 3-5-4
HB and HS alarms were made operational before heater was turned on.	Turn on heater first.	Sec. 1-4-3
Control output is not being used.	HG and HS alarms are synchronous with control output, so control output must be used.	Sec. 3-5-4
Operation is not starting.	Start operation with OS command.	Sec. 3-5
Control output was ON for less than 200 ms.	HB alarm detection will not operate unless control output stays ON for 200 ms.	Sec. 3-5
Control output was OFF for less than 200 ms.	HB alarm detection will not operate unless control output stays OFF for 200 ms.	Sec. 3-5
Heater current exceeds 50 A.	To avoid damage, do not run a current of over 50 A.	App. A
Heater's rated current and actual current differ.	Use Heater Current Read to check actual heater current, and set detection level accordingly.	Sec. 4-2-30

6-2 Loop-Back Communications Test

When there are problems with communications, the loop-back communications test can be used to see if the E5ZD is operating properly. For this test, the E5ZD transmits data out and then directly back into itself to see if the same data is received. The character string sent for the test, shown below, is sent continuously and can therefore also be received by the host computer. Once test communications have started, the string will continue to be sent until the power is turned off.

E5ZD-4/-6□□□-E:

E5ZD_Copyright_1990_OMRON_Corporation↵ (Carriage return)

E5ZD-8□□□-E:

E5ZD_Copyright_1991_OMRON_Corporation↵ (Carriage return)

E5ZD-8H□□M-E:

E5ZD_Copyright_1991_OMRON_Corporation↵ (Carriage return)

Loop-back Test

To prepare for the loop-back test, wire the pins of the communications connector for your model as shown below for RS-232C and RS-422 communications. For RS-485 communications, no special wiring is required because the required pins are connected internally; just turn ON pin 1 of SW5. Set the operation mode to "Test" with the DIP switch.

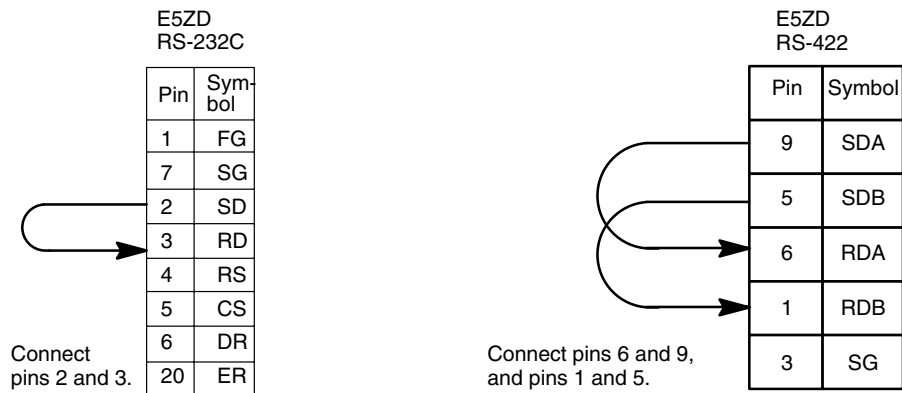

After finishing the above preparations, just turn on power to the E5ZD to start the test. The E5ZD's error output terminal will go ON and the error indicator will light when errors are found in the received character string. When the carriage return is reached in the string, the error output terminals will go OFF and then transmission of the string will begin again.

Receiving at the Host Computer

To receive and check the test at the host computer, set the baud rate and other transmission parameters and connect the host computer and E5ZD with a communications cable. Set up the computer to receive the data, set the operation mode to "Test" on the DIP switch, and then turn on the E5ZD to start transmission of the test data. The test will proceed as described above. Because the E5ZD is not receiving the test character string, the indicator will light and the alarm output will go ON, but these can be ignored. If processing is slow at the host, the host's receiving buffer may fill up. If this happens, slow down the transmission speed.

Appendix A

Specifications

E5ZD Ratings

Item	Specification
Power supply voltage	24 VDC
Allowable power supply range	90% to 110% of rated voltage
Power consumption	E5ZD-4/-6/□□□-E: Approx. 15 W E5ZD-8□□□-E: Approx. 20 W E5ZD-8H□□M-E: Approx. 17 W
Input sensor	K or J thermocouple, or Pt100 or JPt100 platinum resistance thermometer
CT inputs	Special CT (E54-CT1 or E54-CT3)
Control points	4, 6, or 8 points
Control outputs	E5ZD-4/-6/□□□-E Voltage: 40 mA, 12 VDC max. Open collector (NPN): 50 mA, 30 VDC max. E5ZD-8□□□-E Voltage: 30 mA, 12 VDC max. Open collector (NPN): 50 mA, 30 VDC max. E5ZD-8H□□M-E Open collector (NPN): 50 mA, 30 VDC max.
Control modes	E5ZD-8F□□□-E: Hybrid of PID control with feed-forward circuitry and fuzzy (with autotuning) or ON/OFF Other models: PID control with feed-forward circuitry (with autotuning) or ON/OFF
Alarm outputs	Open collector (NPN), 50 mA, 30 VDC max.
Number of memory banks	8
Memory bank designation inputs	Contact: ON-1 k Ω max.OFF-100 k Ω min. No-contact: ON-Residual voltage of 2 V max., OFF-Leakage current is 1 mA max.
Ambient operating temperature	-10° to 55°C (with no icing)
Ambient operating humidity	35% to 85% (with no condensation)
Storage temperature	-25°C to 65°C (with no icing)

E5ZD Characteristics

Item	Specification
Setting accuracy	$\pm 0.5\%$ FS ± 1 digit max.
Designation accuracy	$\pm 0.5\%$ FS ± 1 digit max.
Hysteresis	0.0° to 99.9°C/°F
Proportional band	0.0° to 999.9°C/°F
Integral time	0 to 3,999 s
Derivative time	0 to 3,999 s
Control period	1 to 99 s
Fuzzy strength	0% to 99%
Fuzzy scale 1	0.2°C/°F to 999.9°C/°F
Fuzzy scale 2	0.02°C/°F to 99.99°C/°F
Alarm output setting range (alarms 1 and 2)	-999° to 1,999°C/°F (when unit is 1°C/°F)
	-999.9° to 1,999.9°C/°F (when unit is 0.1°C/°F)
Sampling period	4-point models: 0.4 s for 4 points
	6-point models: 0.5 s for 6 points
	8-point models: 0.5 s for 8 points
Input shift	-99.9° to 99.9°C
Insulation resistance	20 M Ω min. between terminal block and sensor input terminal (at 500 VDC)
Dielectric strength	500 VAC, 50/60 Hz between terminal block and sensor input terminal
Weight	E5ZD-4/-6/□□□-E: Approx. 500 g E5ZD-8□□□-E: Approx. 800 g E5ZD-8H□□M-E: Approx. 650 g
Memory protection	Non-volatile memory (EEPROM), 10 yrs., max. number of writes: 10,000.

Heater Burnout Detection Specifications

Item	Specification
Max. heater current	50 A single phase
Heater burnout detection level setting accuracy	$\pm 0.5\%$ FS ± 1 digit
Input current monitoring accuracy	$\pm 0.5\%$ FS ± 1 digit (between 0 and 50 A)
Heater burnout detection level setting range	0.0 to 50.0 A (Unit: 0.1 A, see note 1)
Input current monitoring range	0.0 to 55.0 A
HS alarm detection current	0.5 A min.
Min. ON detection time	0.2 s (see note 2)
Min. OFF detection time	0.2 s (see note 3)

- Note**
1. Heater burnout detection is canceled when the level is set to 0.0 A.
 2. Heater burnout detection and heater current measurement will not be made when control output is not ON for at least 0.2 seconds.
 3. Heater burnout detection will not be made when control output is not ON for at least 0.2 seconds.

Current Transformer Ratings

Specifications	Model	
	E54-CT1	E54-CT3
Hole diameter	5.8 mm	12.0 mm
Max. continuous heater current	50 A	50 A
Withstand voltage	1,000 VAC for 1 min	
Vibration tolerance	50 Hz (approx 10G)	
Weight	Approx. 11.5 g	Approx. 50 g
Accessories	None	Contacts: 2 Plugs: 2

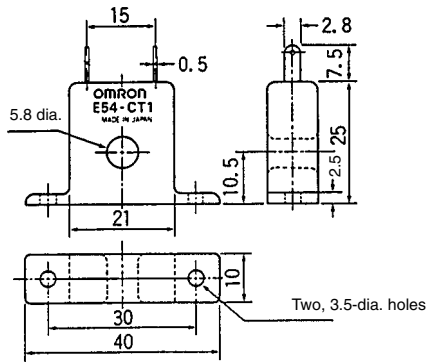

(a) E54-CT 1

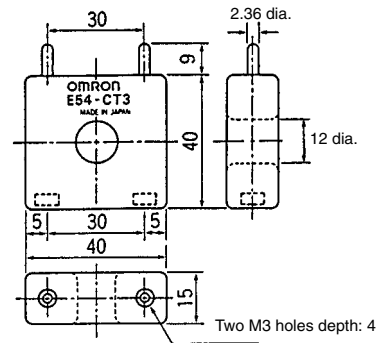

(b) E54-CT 3

Appendix B

Parameter Defaults, Setting Ranges, and Commands

This appendix provides a list of the commands according to the parameters or operations that they control. It also provides the factory-set defaults, the number of digits required to set the parameter, and the parameter's setting limits.

Where possible, commands are given in write-read pairs for the same parameter or operation. The "Write code" is the header code used to write the parameter or operation; the "Read code" is the header code used to read the parameter or status. If the same header code is used for more than one command, the data code is provided with it. Refer to the body of this manual for details.

Commands Controlling Operation

Command	Write code	Read code	Digits
Operation Start	OS	RX-02	0
Operation Stop	OP	RX-02	0
Autotuning Start	AS	RX-02	0
Autotuning Stop	AP	RX-02	0

Commands for Parameters Independent of Control Points

Parameter	Write code	Read code	Digits	Default	Upper	Lower	Remarks
HB/HS Alarm Point	WU-02	RU-02	4	0000	0000	00FF	Bit data
Output Mode	WU-00	RU-00	4	0000	0000	00FF	Bit data

Commands for Parameters for Individual Control Points

Parameter	Write code	Read code	Digits	Default	Upper	Lower	Remarks
Memory Bank Designation	WM	RM	4	0000	0000	0007	---
Alarm Modes 1 and 2	W#	R#	4	0000	0000	000C	---
Detection Level	WW	RW	4	0000	0000	0500	0.1 A unit

Commands Controlling Operations

Command	Header code	Digits	Remarks
Initialize Parameters	MC	0	---
Transmission Test	TS	118	---
Undefined Error	IC	NA	Returned in response for unrecognizable command
EEPROM Write	WE	NA	Writes RAM contents to EEPROM

Commands for Parameters Contained in Memory Banks

Parameter	Write code	Read code	Digits	Default	Upper	Lower	Remarks
Set Temperature	WS	RS	4	0000	FS	FS	Unit: 1°C
				0032	FS	FS	Unit: 1°F
			5	00000	FS	FS	Unit: 0.1°C
				00320	FS	FS	Unit: 0.1°F
Proportional Band	WB	RB	4	0000	0000	9999	Unit: 1°C/°F
Integral Time	WN	RN	4	0000	0000	3999	Unit: s
Derivative Time	WV	RV	4	0000	0000	3999	Unit: s
Control Period	WH	RH	4	0002	0001	0099	Unit: s
Hysteresis	WH	RH	4	0008	0000	0999	Unit: 1°C
				0015	0000	0999	Unit: 1°F
Input Shift	WI	RI		0000	-000	0999	Unit: 0.1°C/°F
Alarm Temperature	W%	R%	4	0000	-999	1999	Unit: 1°C/°F
			5	00000	-9999	19999	Unit: 0.1°C/°F
Fuzzy Strength (Fuzzy-logic Controllers only)	Wj	Rj	4	0050	0000	0099	Unit: 1%
Fuzzy Scale 1 (Fuzzy-logic Controllers only)	Wk	Rk	4	9999	0002	9999	Unit: 0.1°C/°F
Fuzzy Scale 2 (Fuzzy-logic Controllers only)	WI (lower-case l)	RI (lower-case l)	4	9999	0020	9999	Unit: 0.01°C/°F

Other Read Commands

Command	Header code	Digits	Remarks
Measured Temperature Read	RX-00	4	Unit: 1°C
		5	Unit: 0.1°C
Heater Current Read	RZ	4	Unit: 0.1 A
Output Variable Read	RX-01	4	Unit: 0.1%
Output Variable Read	RO	4	Unit: 0.1%
Status Read	RX-02	4	Operating status of E5ZD
Error Read	RU-03	4	Specifies E5ZD error

Appendix C

End Codes

The following is a list of end codes which are returned with responses to commands to indicate the execution status of the command. (If the command was not recognizable, a header code of IC is returned without an end code.) These end codes are explained in more detail in the body of this manual.

End code	Name	Meaning
00	Normal completion	The command was executed correctly.
01	Invalid command	An command was sent that could not be executed under current operating conditions.
04	Invalid address	The control point or memory bank designation is out of range.
10	Parity error	The parity bit was wrong.
11	Framing error	The stop bit was not detected.
12	Overflow error	The reception buffer has overflowed.
13	FCS error	The FCS value was incorrect.
14	Format error	An incorrect format was used for the command.
15	Numeric error	Data was not within specified limits.
18	Frame length error	The command block exceeded 127 characters.
19	Invalid command due to parameter restrictions	Execution of the command is not possible because of parameter settings
21	Error status	Command execution is not possible because an error has occurred in the E5ZD.

Appendix D Error Codes

The following is a list of error codes which are returned instead of end codes when an error has occurred.

Error code	Name	Meaning
E001	Memory error	The memory contents have been destroyed. Turn the E5ZD off and on.
E002	Sensor AD error	The sensor AD converter has failed. Turn the E5ZD off and on.
E003	Cold junction compensation error	This error is generated when CN3 has been disconnected or the ambient temperature of the E5ZD has dropped below -15°C or exceeded 60°C .
E004	CT input AD error	The CT input AD converter has failed.
E011	Sensor error	The sensor input is not correct. Either the sensor is shorted or not wired correctly.
E012	Upper limit error	The measured temperature is 20°C or more over the set temperature range.
E013	Lower limit error	The measured temperature is 20°C or more below the set temperature range.
E022	Heater current upper limit error	The measured heater current value is more than 55 A.

Appendix E

ASCII Codes

Bits 0 to 3		Bits 4 to 7							
BIN		0000	0001	0010	0011	0100	0101	0110	0111
	HEX	0	1	2	3	4	5	6	7
0000	0	NUL	DLE	Space	0	@	P	`	0
0001	1	SOH	DC ₁	!	1	A	Q	a	1
0010	2	STX	DC ₂	"	2	B	R	b	2
0011	3	ETX	DC ₃	#	3	C	S	c	3
0100	4	EOT	DC ₄	\$	4	D	T	d	4
0101	5	ENQ	NAK	%	5	E	U	e	5
0110	6	ACK	SYN	&	6	F	V	f	6
0111	7	BEL	ETB	'	7	G	W	g	7
1000	8	BS	CAN	(8	H	X	h	8
1001	9	HT	EM)	9	I	Y	i	9
1010	A	LF	SUB	*	:	J	Z	j	A
1011	B	VT	ESC	+	;	K	[k	B
1100	C	FF	FS	,	<	L	¥	l	C
1101	D	CR	GS	-	=	M]	m	D
1110	E	S0	RS	.	>	N	^	n	E
1111	F	S1	US	/	?	O	_	o	F

Index

A–C

- alarms, 7, 11
 - enabling, 103
 - example of circuit break using heater circuits, 59
 - HB and HS, 58
 - operation, 58
 - output timing, 7
 - precautions, 58
 - terminal assignments, 16, 27
 - using alarm temperature write: W%, 92
- autotuning, 87
 - precautions, 88
- baud rate, 23, 31, 47
- celcius, 24, 32, 48
- circuit configuration, 15, 29, 43
- command
 - See also* commands
 - alarm mode read: R#, 90
 - alarm mode write: W#, 88
 - alarm point read: RU, 104
 - alarm point write: WU, 103
 - alarm temperature read: R%, 92
 - alarm temperature write: W%, 91
 - autotuning start: AS, 87
 - autotuning stop: AP, 87
 - control period read: RT, 78
 - control period write: WT, 77
 - derivative time read: RV, 78
 - derivative time write: WV, 77
 - detection level read: RW, 106
 - detection level write: WW, 105
 - EEPROM write: WE, 56, 94
 - error read: RU, 101
 - fuzzy scale 1 read: Rk, 110
 - fuzzy scale 1 write: Wk, 109
 - fuzzy scale 2 read: RI, 110
 - fuzzy scale 2 write: WI, 109
 - fuzzy strength read: Rj, 110
 - fuzzy strength write: Wj, 109
 - global read and control operations, 111
 - global write operations, 114
 - heater current read: RZ, 58, 107
 - hysteresis read: RH, 97
 - hysteresis write: WH, 96
 - initialize parameters: MC, 99
 - input shift read: RI, 95
 - input shift write: WI, 95
 - integral time read: RN, 78
 - integral time write: WN, 77
 - measured temperature read: RX, 74
 - memory bank designation read: RM, 86
 - memory bank designation write: WM, 85
 - operation start: OS, 80
 - operation stop: OP, 80
 - output mode read: RU, 82
 - output mode write: WU, 80
 - output variable read: RO (RX), 98
 - proportional band read: RB, 78
 - proportional band write: WB, 76
 - set temperature read: RS, 73
 - set temperature write: WS, 71
 - status read: RX, 83
 - transmission test: TS, 99
- command block, 53
- commands, 68
 - EEPROM Write, 120
 - response time, 6
 - summary tables, 133
- communications, 3
 - See also* RS–232, RS–422 or RS–485
 - block format, 53
 - command block, 53
 - connector, 11
 - error, 53
 - FCS calculations, 53
 - indicators, 124
 - loop back test, 128
 - procedure, 52
 - serial, 2
 - specifications, 18
 - stabilization, 7
- connectors, 11
- control operations, 111
- control outputs, 15, 29, 42
- control period, 76, 78
- controller
 - alarms, 11
 - See also* alarms
 - assigning a unit number, 23, 31, 47
 - changing between fahrenheit and celcius, 24, 32, 48
 - circuit configuration, 15, 29, 43
 - commands. *See* instructions
 - communications, 2, 3, 11
 - See also* communications; RS–232, RS–422 or RS–485
 - indicators, 124
 - procedure, 52
 - specifications, 18
 - connectors, 11
 - control outputs, 15, 29, 42
 - current transformer, 2, 4
 - diagnostic functions, 2
 - dimensions, 10
 - DIP switch settings, 5, 11, 23, 31, 47
 - environment, 5
 - features, 2
 - indicators, 12, 33, 49
 - installation, 4
 - memory, 2, 14, 28, 42, 54
 - See also* memory
 - models, 3
 - mounting, 5, 12
 - operating precautions, 5
 - operating temperature range, 4, 5
 - output indicators, 125
 - power supply, 5, 14, 28, 42
 - precaution, 4
 - signal input, 15, 29, 42
 - terminal assignments, 13, 26
- CPU, 2
- current transformer, 4

D–F

dimensions, 10
DIP switch settings, 5, 11, 23, 31, 47
E5ZD. *See* controller
EEPROM, 56
EEPROM Write, 120
end codes, 69
error
 checks performed by the controller, 53
 heater burnout detection, 127
 in communication, 53
 using heater current read: RZ, 108
 using measured temperature read, 76
error codes, 71
example
 calculating read transmission time, 121
 calculating write transmission time, 120
 set temperature read, 73
 set temperature write, 72
 triggering the HB alarm, 59
fahrenheit, 24, 32, 48
FCS calculations, 53
fuzzy logic, 3, 60
 adjusting parameters, 64
 affects of adjusting parameters, 62
 affects of autotuning, 61
 application, 61
 commands, response time, 6
 commands to read constants, 110
 commands to set constants, 109
 configuration, 60
 disabling, 63
 fuzzy scale 1, 62
 fuzzy scale 2, 62
 fuzzy strength, 62
 models, 4
 operating principles, 60
 parameters, 62
 relation to autotuning, 87
 relation to PID constants, 61
fuzzy scale 1
 reading from host computer, 110
 writing from host computer, 109
fuzzy scale 2
 reading from host computer, 110
 writing from host computer, 109
fuzzy strength
 reading from host computer, 110
 writing from host computer, 109

G–M

global operations, 111, 114
header codes, 69
heater burnout, detection, 127
hybrid control, 3
indicators, 12, 33, 49
installations, 4

loop back test, 128
memory
 backup, 56
 designations, 55
 structure, 55
 terminals, 14, 28, 42
models
 fuzzy logic, 4
 standard, 3
mounting, methods, 12
Multipoint Temperature Controller. *See* controller

N–R

noise, 5
 creating communication errors, 53
output indicators, 125
outputs
 protection, 7
 type, 7
parameters, defaults, 133
PID, 2, 76, 78
power supply, 5, 58
 terminals, 14, 28, 42
precautions, 4
 handling, 4
 installation, 4
 operating, 5
RAM, 56
reading times, 120
response time, commands, 6
RS–232, 18
RS–422, 18, 20
RS–485, 18, 21

S–W

sampling time, 2
setting ranges, 133
shielded cable, 5
signal input method, 15, 29, 42
specifications, 129
SSR failure, 58
Temperature Controller. *See* controller
temperature range, 4, 5, 71
terminals
 assignments, 13, 16, 26, 27
 connecting type, 17
 memory bank, 14, 28, 42
 power supply, 14, 28, 42
transformer, 4
transmission time
 read operation, 120
 write operation, 120
unit number, assignation, 23, 31, 47
writing times, 120

Revision History

A manual revision code appears as a suffix to the catalog number on the front cover of the manual.

Cat. No. Z042-E1-4
 Revision code

The following table outlines the changes made to the manual during each revision. Page numbers refer to the previous version.

Revision code	Date	Revised content
1	February 1990	Original production
2	May 1992	Previous version was completely rewritten and major additions of new information and feature descriptions were made.
3	September 1992	Information was added for new Fuzzy-logic Controllers as follows: Page 3: Fuzzy-logic Controllers listed. Pages 5 and 6: Precautions added. Page 61: Fuzzy parameters added to diagram. Page 62: <i>Caution</i> revised. Page 65: Description of fuzzy-logic control added. Page 68: Commands for fuzzy-logic control added to table. Page 87: Precautions and other information added for autotuning. Page 100: Fuzzy parameters added to table. Page 108: New sections added on commands for fuzzy-logic control. Page 112: Commands for fuzzy-logic control added to table. Page 115: Commands for fuzzy-logic control added to table. Page 117 to 119: Information added to entire section. Pages 127 and 128: Fuzzy-logic specifications added. Page 132: Commands for fuzzy-logic control added to table.
3A	June 1994	Information for switches SW5 and SW503 has been corrected to say "All pins are set to OFF at the factory" throughout the manual. "-E" was added to the end of all E5ZD Multipoint Temperature Controller model numbers. A list of these can be found on pages 3 and 4 of the manual. Pages 37, 39, 41, 43, 45, 48, and 132: Information on ES1000-TR011 was removed and the second paragraph in section 2-3-5 was changed. Pages 38, 39, 40, 41, 43, and 49 to 52: Information on ES1000-TR031 was removed.
4	November 1996	Pages 19, 20, and 22: Plug model numbers corrected.

OMRON CORPORATION
Industrial Automation Company

Measuring and Supervisory Controls Department
28th Fl., Crystal Tower Bldg.,
1-2-27, Shiromi, Chuo-ku,
Osaka 540-6028 Japan
Tel: (81)6-6949-6035/Fax: (81)6-6949-6069

Regional Headquarters

OMRON EUROPE B.V.
Wegalaan 67-69, NL-2132 JD Hoofddorp
The Netherlands
Tel: (31)2356-81-300/Fax: (31)2356-81-388

OMRON ELECTRONICS, INC.
1 East Commerce Drive, Schaumburg, IL 60173
U.S.A.
Tel: (1)847-843-7900/Fax: (1)847-843-8568

OMRON ASIA PACIFIC PTE. LTD.
83 Clemenceau Avenue,
#11-01, UE Square,
Singapore 239920
Tel: (65)835-3011/Fax: (65)835-2711

OMRON (CHINA) CO. LTD.
21F, Beijing East Ocean Center
No. 24A Jian Guo Men Wai Da Jie
Chao Yang District, Beijing, 100022
China
Tel: (86)10-6515-5778/Fax: (86)10-6515-5810

OMRON

Authorized Distributor:

Cat. No. Z042-E1-4

E5ZD Multipoint Temperature Controller

OPERATION MANUAL

OMRON