

F150-3 Vision Sensor

Expert Menu Operation Manual

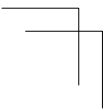





Notice:

OMRON products are manufactured for use according to proper procedures by a qualified operator and only for the purposes described in this manual.

The following conventions are used to indicate and classify precautions in this manual. Always heed the information provided with them. Failure to heed precautions can result in injury to people or damage to property.

-  **DANGER** Indicates an imminently hazardous situation which, if not avoided, will result in death or serious injury.

-  **WARNING** Indicates a potentially hazardous situation which, if not avoided, could result in death or serious injury.

-  **Caution** Indicates a potentially hazardous situation which, if not avoided, may result in minor or moderate injury, or property damage.

Visual Aids

The following headings will help you locate different types of information.

Note Indicates information of particular interest for efficient and convenient operation of the product.

→ Indicates pages where additional information can be found.

1 Indicates a procedure. The step numbers in the procedure correspond to the numbers in any related illustrations.

Trademark

DeviceNet is a registered trademark of the Open DeviceNet Vendor Association, Inc.

© OMRON, 2000

All rights reserved. No part of this publication may be reproduced, stored in a retrieval system, or transmitted, in any form, or by any means, mechanical, electronic, photocopying, recording, or otherwise, without the prior written permission of OMRON.

No patent liability is assumed with respect to the use of the information contained herein. Moreover, because OMRON is constantly striving to improve its high-quality products, the information contained in this manual is subject to change without notice. Every precaution has been taken in the preparation of this manual. Nevertheless, OMRON assumes no responsibility for errors or omissions. Neither is any liability assumed for damages resulting from the use of the information contained in this publication.

TABLE OF CONTENTS

PRECAUTIONS	xi
1 Safety Precautions	xii
2 General Precautions	xiii
SECTION 1	
The Expert Menu Mode	1
1-1 Features	2
1-2 Measurement Methods	4
1-3 Menu Tree	12
1-4 Overview of F150 Installation and Operation	16
1-5 Input and Output	17
SECTION 2	
Basic Operations	19
2-1 Starting and Quitting	20
2-2 Menu Operations	22
2-3 Two-camera Unit	29
2-4 Intelligent Light Source	41
SECTION 3	
Setting Measurement Conditions	45
3-1 Entering Set Mode	46
3-2 Adjusting Images	47
3-3 Position Displacement Compensation	62
3-4 Drawing Measurement Regions and Setting Evaluation Criteria	80
3-5 Output Expressions	122
3-6 Scenes	132
3-7 Initializing Measurement Conditions (Clearing Scenes)	135
SECTION 4	
Monitor Mode and Run Mode	137
4-1 Confirming Correct Operation	138
4-2 Run Mode	151

TABLE OF CONTENTS

SECTION 5	
System Settings	155
5-1 Entering System Mode	156
5-2 Measurement Result Output Destinations	157
5-3 Two-camera Unit and Intelligent Light Source	158
5-4 Measurement Screen Settings	160
5-5 Storing Measured Images	162
5-6 Changing Console Key Allocations	169
5-7 Setting Startup Conditions	172
5-8 Selecting Output Method for Error Terminal	174
5-9 Checking the Software Version	175
SECTION 6	
Backing Up Data	177
6-1 Saving/Loading System and Scene Data	178
6-2 Saving to Flash Memory	181
SECTION 7	
Terminal Block	183
7-1 Communications Settings	184
7-2 I/O Formats	187
7-3 Terminal Signal Operation and Timing	189
SECTION 8	
RS-232C Normal Settings	197
8-1 Communications Settings	198
8-2 Command List	205
8-3 Input Format	207
8-4 Input Commands	207
8-5 Measurement Results Output Format	229
SECTION 9	
RS-232C Host Link Settings	231
9-1 Communications Settings	232
9-2 Command Tables	241
9-3 Input Format	242
9-4 Output Format	262
9-5 Sample Ladder Program	265



TABLE OF CONTENTS

SECTION 10	
CompoBus/D Settings	269
10-1 Communications Settings	270
10-2 Input Format	278
10-3 Output Format	301
10-4 Timing Charts	309
10-5 Allocation Charts	315
10-6 Sample Ladder Program	318
SECTION 11	
RS-232C Menu Operation Settings	323
SECTION 12	
Troubleshooting	327
Appendices	
A Version Information	331
Index	335
Revision History	341

About this Manual:

This manual describes the operation of the F150 Vision Sensor using the Expert Menu and includes the sections described below. This is one of two manuals used to operate the F150. Refer to the following table for the contents of each manual.

Manual	Contents	Cat. No.
1: Setup Manual	Provides information on system hardware and installation. Be sure to read this manual first.	Z141-E1-1
2: Expert Menu Operation Manual	Describes operation of the F150 using the Expert Menu. The Expert Menu enables application of all F150 capabilities, including setting region images and criteria, and outputting judgement results and data via the terminal blocks, RS-232C or CompoBus/D.	Z142-E1-1

Please read the above manuals carefully and be sure you understand the information provided before attempting to install and operate the F150.

Section 1 The Expert Menu Mode outlines the features of the Expert Menu and explains what can be achieved using it.

Section 2 Basic Operations describes the overall flow of F150 application and basic operations.

Section 3 Setting Measurement Conditions describes the settings required for F150 operation.

Section 4 Monitor Mode and Run Mode explains how to check if measurements are being correctly performed with the set measurement conditions using Monitor mode, and how to make actual measurements using Run mode.

Section 5 System Settings explains how to set conditions related to the system environment.

Section 6 Backing Up Data explains how to make backup copies of data to flash memory or a computer.

Section 7 Terminal Block describes the communications settings and I/O formats for communications with external devices via the terminal blocks.

Section 8 RS-232C Normal Settings describes the communications settings for the RS-232C port when communications are set for Normal mode.

Section 9 RS-232C Host Link Settings describes the communications settings for the RS-232C port when communications are in Host Link mode.

Section 10 CompoBus/D Settings describes the communications settings required when the F150 is used as a CompoBus/D Slave.

Section 11 RS-232C Menu Operation Settings describes the communications settings for the RS-232C port when communications are in Menu operation mode.

Section 12 Troubleshooting lists the errors that may occur during F150 operation, along with their probable causes and countermeasures.

Appendix A Version Information describes functions that have been added with this version and provides details on data compatibility with previous versions.



WARNING

Failure to read and understand the information provided in this manual may result in personal injury or death, damage to the product, or product failure. Please read each section in its entirety and be sure you understand the information provided in the section and related sections before attempting any of the procedures or operations given.

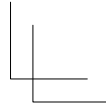
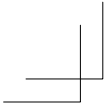

PRECAUTIONS

This section provides general precautions for using the F150 Vision Sensor.

The information contained in this section is important for the safe and reliable application of the F150 Vision Sensor. You must read this section and understand the information contained before attempting to set up or operate a F150 Vision Sensor.

1 Safety Precautions	xii
2 General Precautions	xiii

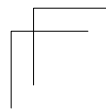
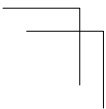



1 Safety Precautions

 **Caution** Do not touch fluorescent or halogen lights while the power is ON or immediately after the power is turned OFF. These lights generate heat and can cause burns.





 **Caution** Do not use the F150 in environments with flammable or explosive gases.

 **Caution** Install the F150 away from high-voltage equipment or motors to ensure safety during operation and maintenance.

 **Caution** Use crimp terminals for wiring. Do not connect bare stranded wires directly to terminals.

 **Caution** Cover the terminal blocks with the Terminal Block Protection Covers after wiring.

 **Caution** Use DC power supplies with safe extra low-voltage circuits that prevent occurrences of high voltages in the main F150 power supply and power supplies for the terminal blocks.

 **Caution** Use the power supply cables and crimp terminals of specified sizes.

 **Caution** Use at the power supply voltages specified in this manual.

 **Caution** Be sure to securely tighten the screws when mounting F150 components.

 **Caution** Do not dismantle, repair or modify any F150 components.

 **Caution** Dispose of F150 components as industrial waste.

2 General Precautions

The user must operate the product according to the performance specifications described in the relevant manuals.

Before using the product under conditions which are not described in the manual or applying the product to nuclear control systems, railroad systems, aviation systems, vehicles, combustion systems, medical equipment, amusement machines, safety equipment, and other systems, machines, and equipment that may have a serious influence on lives and property if used improperly, consult your OMRON representative.

Make sure that the ratings and performance characteristics of the product are sufficient for the systems, machines, and equipment, and be sure to provide the systems, machines, and equipment with double safety mechanisms.



SECTION 1

The Expert Menu Mode

This section outlines the features of the Expert Menu mode and explains what can be achieved using it. The Expert Menu mode enables use of all the capabilities of the F150.

1-1	Features	2
1-2	Measurement Methods	4
1-2-1	Binary Center of Gravity and Area	4
1-2-2	Binary Center of Gravity and Axis Angle	5
1-2-3	Gray Search and Precise Search	6
1-2-4	Gray Edge Position	7
1-2-5	Edge Pitch	8
1-2-6	Surface Defect	9
1-2-7	Density Averaging	10
1-2-8	Relative Search	10
1-3	Menu Tree	12
1-3-1	Without Two-camera Unit	12
1-3-2	With Two-camera Unit	13
1-4	Overview of F150 Installation and Operation	16
1-5	Input and Output	17

1-1 Features

The F150 features supported by the Expert Menu mode are described below.

Measurement Enhancement → p 48, 49

By emphasizing the edge of the measurement object and reducing noise, the F150 ensures effective object measurement.

Shutter Speed → p 47

The shutter speed can be selected to suit the speed of movement of the measurement object.

Lighting Control → p 41, 59

The illuminated area and the light level can be controlled from the F150. (Only available when Intelligent Camera with Light Source is connected.)

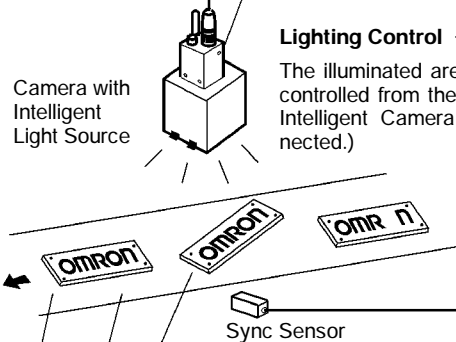

Camera with Intelligent Light Source

Sync Sensor

Position Displacement Compensation → p 62

Position displacement compensation can be used to correct the position of the measurement object using gray search, binary center of gravity and area, binary center of gravity and axis angle or gray edge position.

Changing Scenes → p 131

Up to 16 different sets of measurement conditions can be set. Each set of measurement conditions is called a "scene." You can switch scenes to automatically change the measurement conditions, e.g. to those for a different measurement object.

Nine Measurement Methods → p 4

Any of the following measurement methods can be used.

- Binary center of gravity and area
- Binary center of gravity and axis angle
- Gray search
- Precise search
- Gray edge position
- Edge pitch
- Surface defect
- Density averaging
- Relative search

Measurement Images → p 160

Up to 23 measurement images are stored in memory for easy confirmation of past images to see what problems have occurred.

The images in memory are cleared when power is turned OFF or the scene is changed. These images, however, can be backed up to a computer.

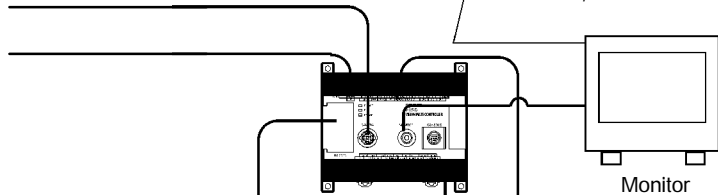

Calibration → p 50

The measurement value can be converted to physical units (e.g., cm or mm) and output to an external device.

Terminal Block, RS-232C Port, CompoBus/D → p 17, 121

The F150 can communicate with Programmable Controllers and other external devices via terminal blocks, RS-232C port, or CompoBus/D. Calculations can be performed on measurement results, or math functions can be used to calculate the distance between two regions or the maximum measurement results. The external devices with which communications are supported, and the formats for communications vary with the model.

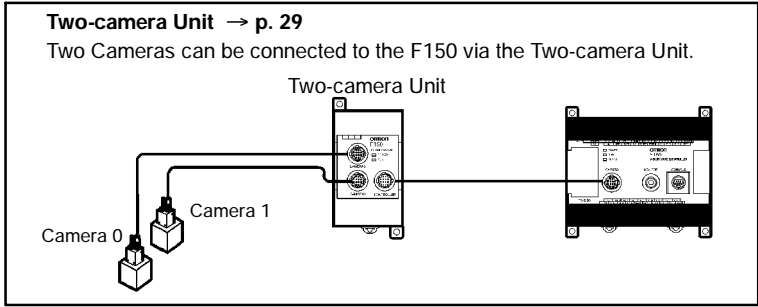
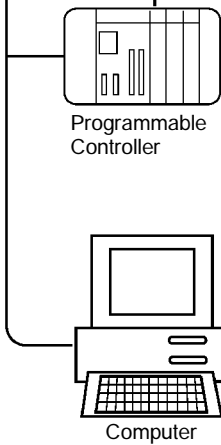

1-2 Measurement Methods

1-2-1 Binary Center of Gravity and Area

This method is used to obtain the size and position of an object. Density images with 256 gradations are read by the Camera. These density images are separated into black pixels and white pixels. The F150 uses the white pixels to measure the object.

Area The area is the number of white pixels inside the measurement region.

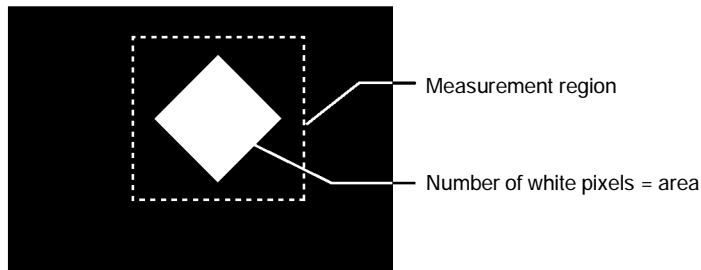

Note If the number of white pixels is the same as an acceptable product, the product will be accepted even if the shape is different. To discriminate objects by shape, use either gray search or precise search.

Center of Gravity

The center of gravity is calculated by regarding the white pixels as a sheet of thick paper of uniform thickness. The center of gravity is the point at which the sheet of paper would balance when placed on a sharp point. For example, the center of gravity for a circular object would be the center of the circle. The center of gravity of a rectangular object would be the intersection of lines drawn from diagonally opposite corners.

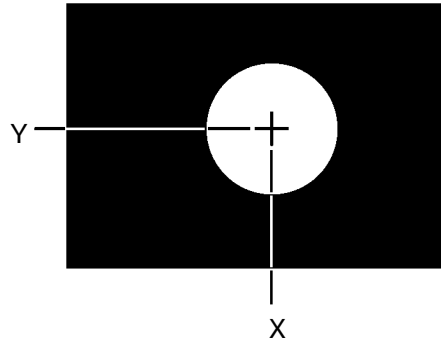

The coordinates for the center of gravity are obtained. These coordinates can be used for position displacement compensation.

1-2-2 Binary Center of Gravity and Axis Angle

In addition to the binary center of gravity and area calculations described previously, an axis angle can also be calculated. This method is used to obtain the orientation of an object. More processing time, however, is required to calculate the axis angle. Use the binary center of gravity and area measurement method unless alignment of the axis angle is required.

Axis Angle The axis angle is the angle of the major axis of an ellipse that is diagrammatically equivalent to the area occupied by the white pixels.

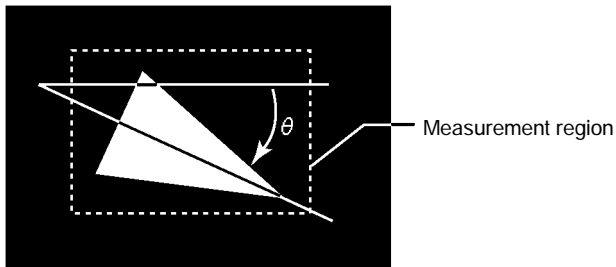

The coordinates for the center of gravity and the axis angle are obtained. This data can be used for position displacement compensation.

1-2-3 Gray Search and Precise Search

Use gray search and precise search to inspect the shape of an object.

- 1 An image pattern for a satisfactory product is registered in advance. This is referred to as the model.

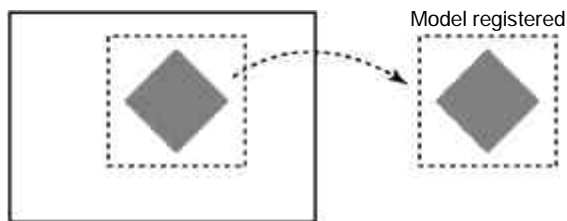

2 The part of the input image that most corresponds to the model is found. The extent of conformity with the model is expressed as a correlation value. A correlation value between 0 and 100 is displayed. The higher the correlation value, the more similar the input image is to the model. By setting a threshold for this correlation value, OK (acceptable) and NG (unacceptable) products can be distinguished.

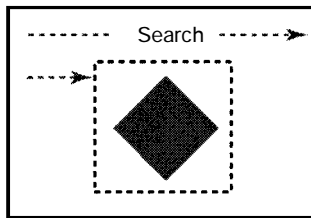

Correlation value: 95

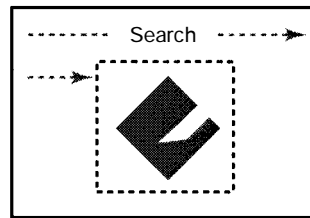

Correlation value: 52

The correlation value is low because part of the image is missing.

In addition to the correlation value, the coordinates of the position of the model can be obtained and used for position displacement compensation.

The level of precision with which the position is obtained, differs between gray searches and precise searches.

- Gray Search
With gray searches, the position is obtained in pixel units.
- Precise Search
With precise searches, the position is obtained in sub-pixel units (units smaller than pixels). The processing time for this search method is longer than for a gray search.

1-2-4 Gray Edge Position

Use gray edge position to locate the edge of an object.

Set the search direction and the change in color for each region.

- Direction: select one from →, ←, ↑ or ↓.
- Color: select one from "Light → Dark," "Dark → Light."

Example 1

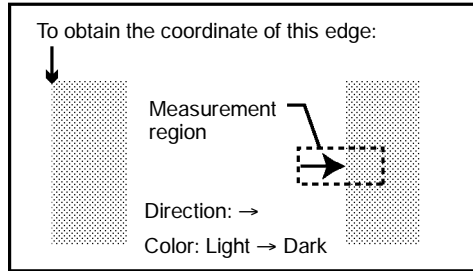

This method can also be used for position displacement compensation.

Example 2

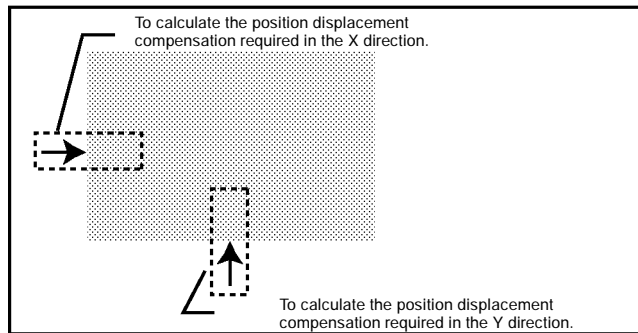

1-2-5 Edge Pitch

Use edge pitch to find the number of objects. This method is useful when monitoring different models mixed together such as ICs and connectors, and for distinguishing different types of model.

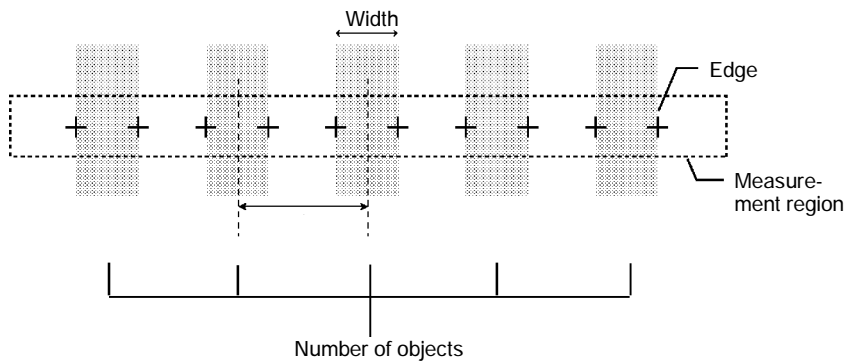

1-2-6 Surface Defect

This method checks for surface defects by measuring variations in density. The shape of the measurement region can be chosen from arc, box, circumference, or line.

- 1 Small boxes are created in the measurement region. These boxes are called "elements." The density for each element is calculated.

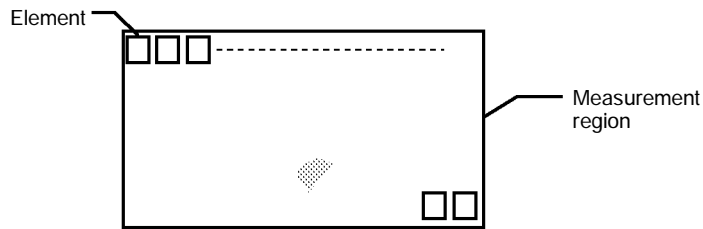

The size of the elements and the interval between each one can be changed from the menu.

- 2 The difference in density between an element above and an element to the left in the same row is calculated for each element. The larger of these intervals is the defect for the element.

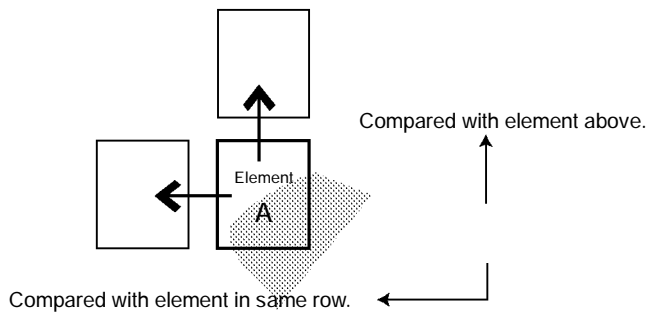

- 3 The defect is calculated for all of the elements. If the largest defect is larger than the evaluation criteria, the measurement region is judged to contain a defect. When deciding the evaluation criteria, perform measurements of several samples and base the evaluation criteria on the defects for those samples.

Note Since inspection is performed by variations in density, if a design or mark is contained inside the measurement region, this will be detected as a defect. When inspecting an area containing a design or mark, use a gray search or a precise search. The image will be compared with the model, and the level of similarity (the correlation) will be obtained.

1-2-7 Density Averaging

Use density averaging to perform measurement based on differences in the average brightness. The density averaging function obtains the density for each pixel (between 0 and 255), obtains the average, and performs measurement on this value.

Example: Existence of Measurement Object

Density averaging can be used to verify the existence of a measurement object.

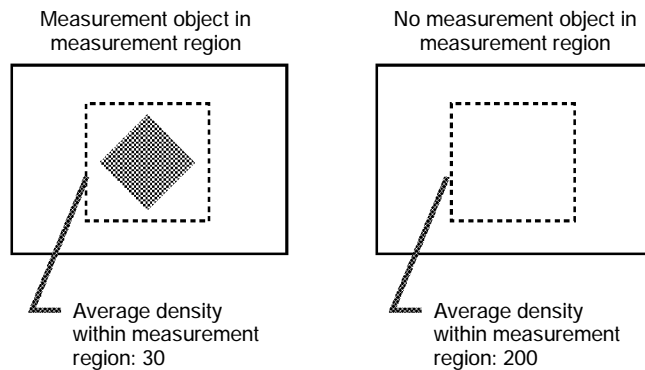

1-2-8 Relative Search

Use this method to obtain the positions of markings, holes, and other features, and to judge whether these features are within the acceptable range. This method is based on relative position, so models must be registered in two positions: a measurement position and a reference position.

Example: Checking the Position of a Label

The relative search function can be used to confirm the position of a label by checking the relative positions of the label and one corner of the measurement object.

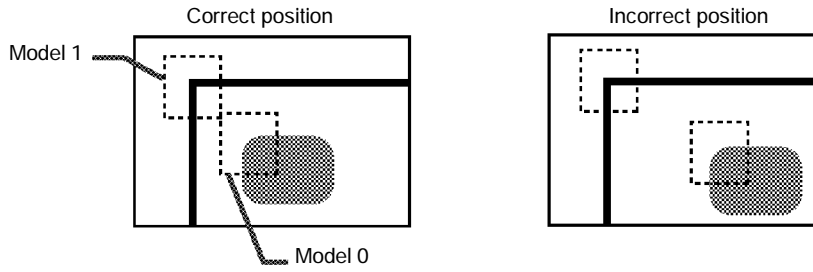

1-3 Menu Tree

1-3-1 Without Two-camera Unit

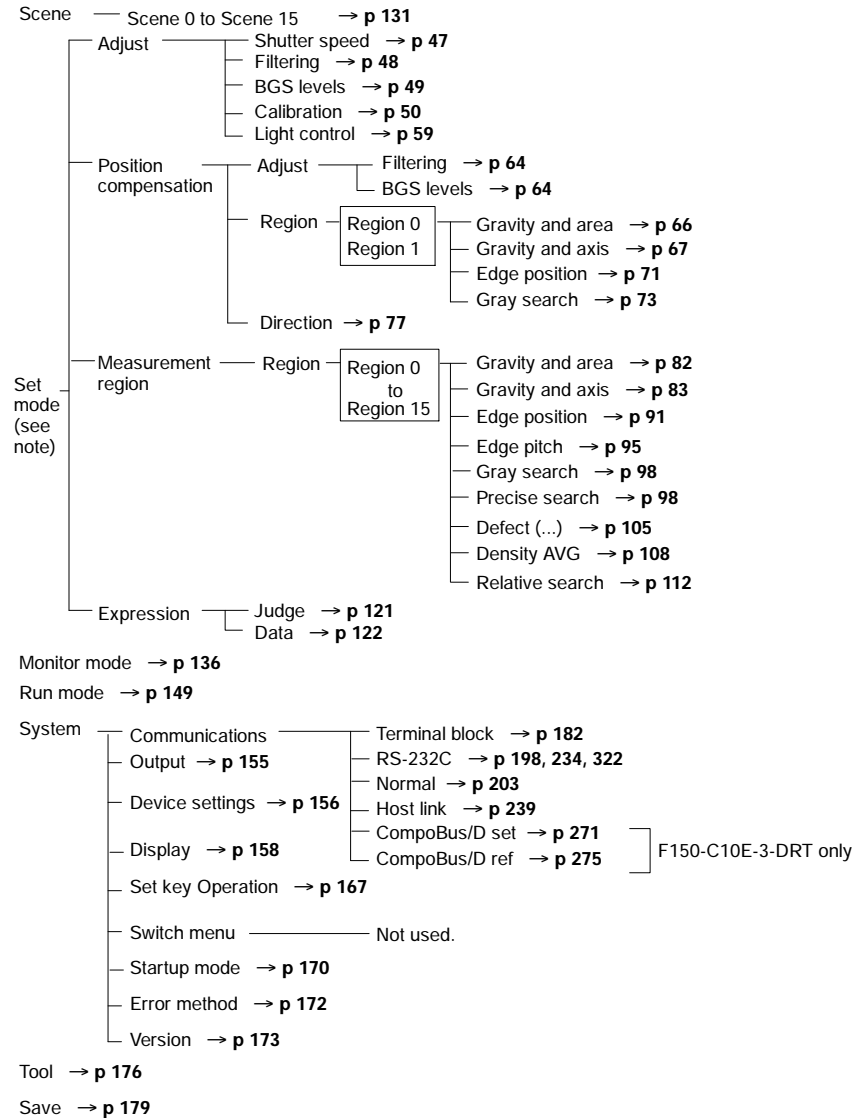

Note When the Two-camera Unit is used, the menu configuration for Set mode will be different. Refer to the following pages for details.

1-3-2 With Two-camera Unit

Two-camera Switching Mode

Camera 0

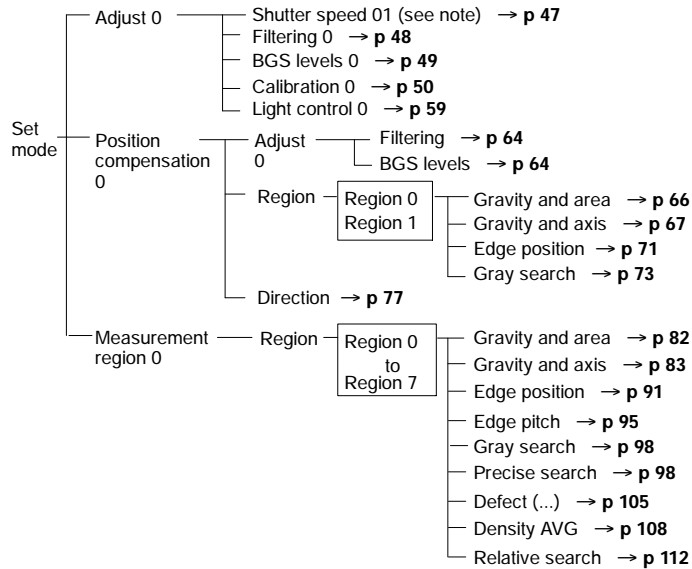

Note The shutter speed 01 setting under **Adjust 0** applies to both Camera 0 and Camera 1.

Camera 1

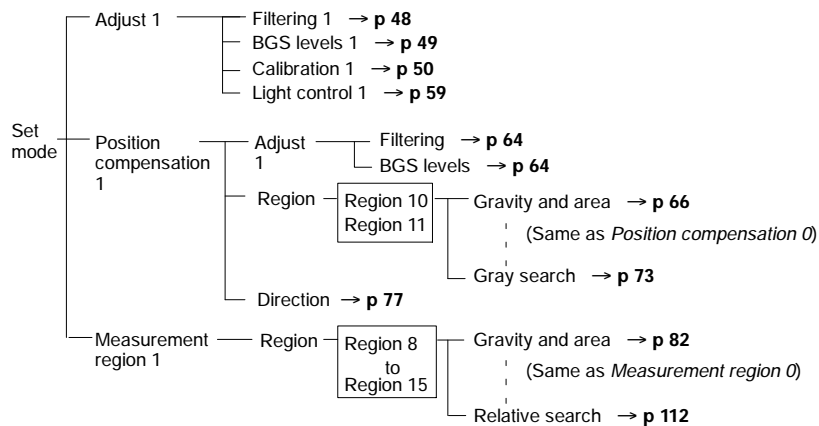

Both Cameras

- Expression
 - Judge → p 121
 - Data → p 122

Vertical Composition Mode, Horizontal Composition Modes 1 and 2

Camera 0

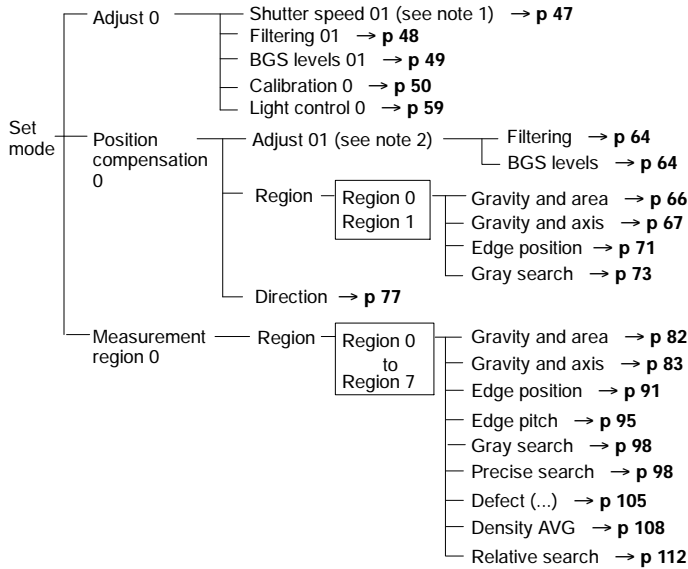

Camera 1

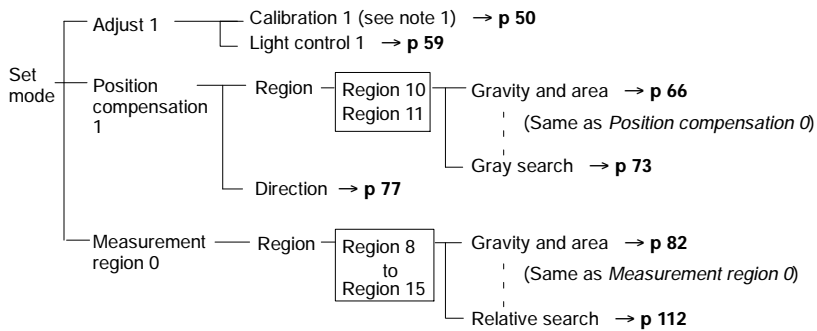

Both Cameras

- Expression
 - Judge → p 121
 - Data → p 122

Note The shutter speed 01, filtering 01, and BGS levels 01 settings under adjust 0, and the adjust 01 setting under position compensation 0 are common to Camera 0 and Camera 1.

Camera 0 Mode, Camera 1 Mode

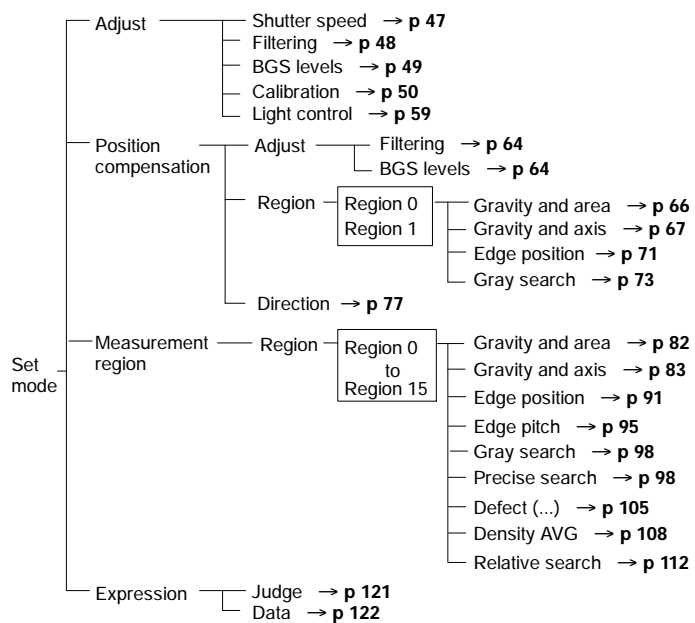

1-4 Overview of F150 Installation and Operation

The following table shows the basic steps that must be performed to use the F150.

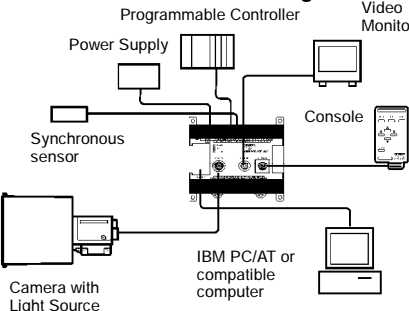
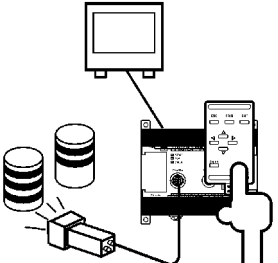
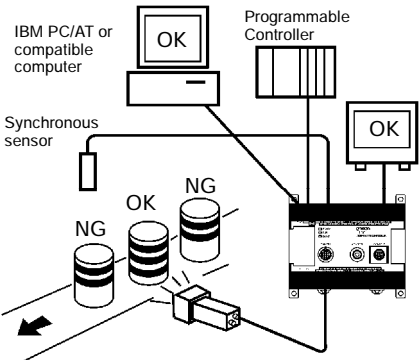
Step	Manual
<p>1: Unit Connections and Wiring</p> 	<p>Setup Manual</p>
<p>2: Setting Measurement Conditions</p> 	<p>Expert Menu Operation Manual</p>
<p>3: Confirming Operation, Measuring Objects, and Outputting Results</p> 	

1-5 Input and Output

The kind of communications supported varies according to the model as shown below.

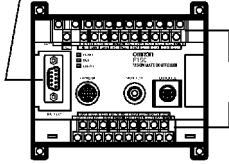
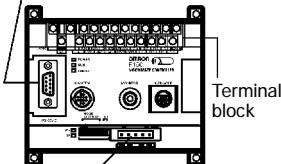
Item		F150-C10E-3, F150-C15E-3	F150-C10E-3-DRT
External communications		Connector for RS-232C connections 	Connector for RS-232C connections  Terminal block Connector for CompoBus/D connections
Input	Console	Yes	Yes
	RS-232C	Normal	Yes
		Host link	Yes
	Terminal block	Yes	Yes (except DI0 to DI7)
	CompoBus/D	No	Yes
Output	RS-232C	Normal	Yes
		Host link	Yes
	Terminal block	Yes	Yes (except DO0 to DO15)
	CompoBus/D	No	Yes



SECTION 2

Basic Operations

This section describes the overall flow of F150 application and basic operations.

2-1	Starting and Quitting	20
2-1-1	Starting	20
2-1-2	Quitting	20
2-2	Menu Operations	22
2-2-1	Input Devices	22
2-2-2	Screen Displays	23
2-2-3	Menu Tree	25
2-2-4	Inputting Values	26
2-2-5	Triangle Mark	26
2-2-6	Drawing a Region	28
2-3	Two-camera Unit	29
2-3-1	Two-camera Unit Menus	32
2-3-2	Camera Modes	34
2-4	Intelligent Light Source	41

2-1 Starting and Quitting

2-1-1 Starting

Note Before connecting components or wiring power supply lines and grounding wires, be sure to refer to the relevant section in the Setup Manual.

Use the following procedure to start up the F150.

- 1** Be sure that the basic F150 components have been connected correctly. → **Setup Manual p. 7**
- 2** Turn ON the power supply on the monitor.
- 3** Turn ON the power supply on the F150.
A startup message will appear followed by a processing message. After a short pause, the initial screen will appear. The following screen will appear the first time power is turned ON.

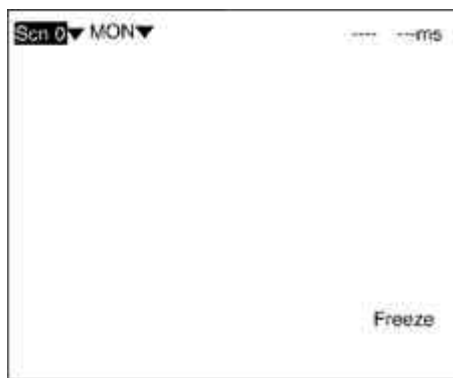

Note The startup scene and startup mode that appear when power is turned ON can be set. Use these settings to make daily operation more efficient once the F150 is ready for actual operation.
→ p 170

2-1-2 Quitting

Save all settings to flash memory before turning OFF the power. The data in flash memory is loaded each time the F150 is started. Any changes made will be lost unless they are saved to the flash memory.

The measurement images and sample images in memory are also cleared when the power is turned OFF. These images can-

not be saved to flash memory, but they can be backed up on a computer if required. → p 179

! Caution Do not turn OFF the power or input a RESET signal while a message is being displayed in any save or load operation. Data in memory will be destroyed, and the F150 may not operate correctly the next time it is started.

1 Display the Basic Screen.



2 Move the cursor to **MON** and press the **ENT** Key.

3 Select **SAVE**.

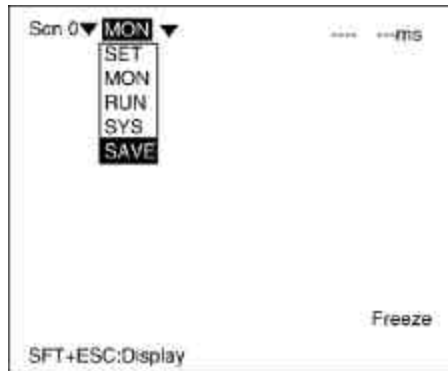

4 A confirmation message will be displayed. Select **Execute** to save any changes.

When saving is completed, the screen from step 1 will be returned.

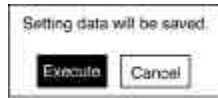

5 Turn OFF the power to the F150.

2-2 Menu Operations

2-2-1 Input Devices

The menu operations are performed from either the Console or the RS-232C.

Console

The Console is used to perform menu operations. Be sure to familiarize yourself with Console operations before actually using the menus.

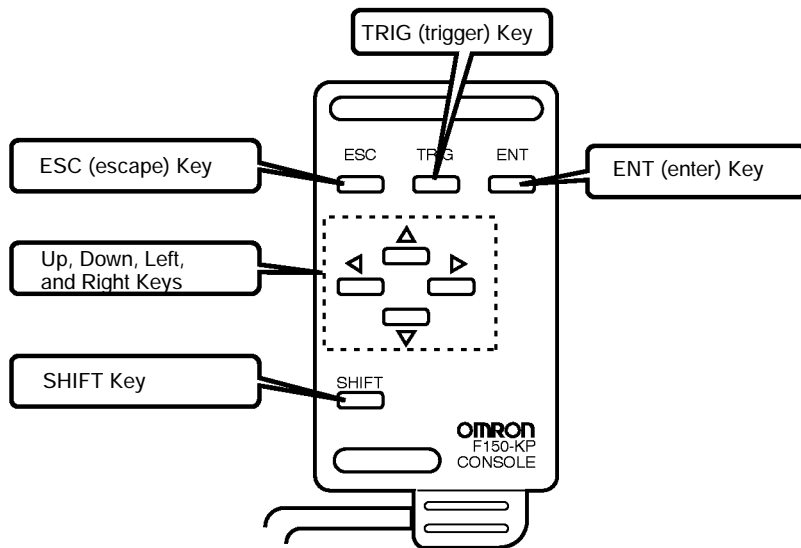

Key	Function
ESC: Escape Key	The function of this key varies with the screen displayed. The function is displayed at the bottom of the screen. When moving between menus, pressing this key interrupts processing and returns the user to the previous menu display.
TRIG: Trigger Key	Starts object measurement.
ENT: Enter Key	Executes a function or sets a value.
Up and Down Keys	Used to move the cursor up and down to select items. Also used to set values. The Up Key will increase a value by 1 and the Down Key will decrease a value by 1. Continue pressing the Up or Down Key to quickly increase or decrease a value.
Left and Right Keys	Used to move the cursor left or right to select items.
SHIFT Key	Must be pressed in combination with another key to have any effect. Specific functions are assigned to SHIFT + another key for specific screens.

RS-232C

Operations equivalent to using the Console keys can be performed from a computer via RS-232C. → p 321

2-2-2 Screen Displays

The F150 is operated by selecting functions displayed on the screen. Familiarize yourself with each function before operating the F150.

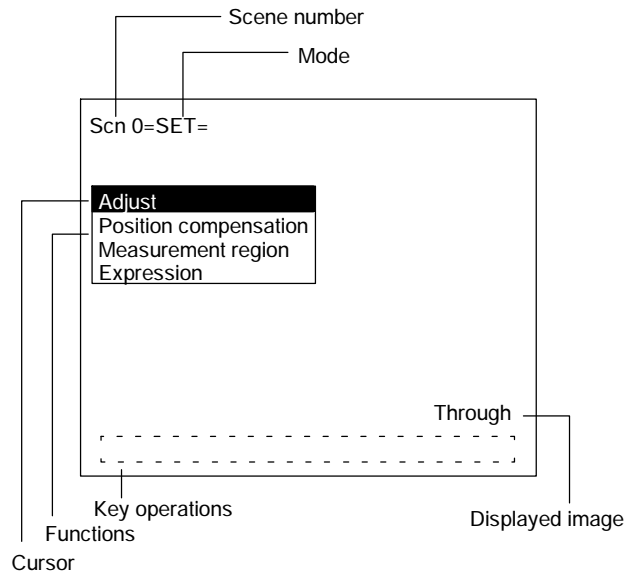

Scene Number The current scene number is given. There are 16 scenes that can be created.

Mode The current operating mode is displayed.

Display	Meaning
SET	Sets the measurement conditions.
MON (Monitor)	Checks whether measurement is being performed correctly under the set measurement conditions. The measurement results are displayed on the monitor only. The results cannot be output to external devices.
RUN	Performs measurement. The measurement results are output to an external device via a terminal block or RS-232C.
SYS (System)	Sets system conditions for the F150.
TOOL	Saves settings and images to a computer as backup.
SAVE	Saves data to flash memory. If new settings have been made, be sure to save the data before quitting.

Displayed Image The type of image being displayed is shown. → p 164

Display	Meaning
Through	The image taken by the Camera is displayed directly.
Freeze	A still of the image taken by the Camera is displayed.
...memoryj j	A previously measured image stored in memory is displayed. With the F150, a maximum of 24 (0 to 23) measurement images can be stored in memory.

Key Operations Displays special key combinations at the bottom of the screen where available.

Functions The available functions are displayed on the menus.

Cursor The cursor is moved to the desired function by pressing the Cursor Keys.

2-2-3 Menu Tree

F150 menus are hierarchical. The cursor is moved to the required functions to set measurement conditions. Use the following procedure to move around the menu tree.

- 1 Move the cursor to the desired function, using the **Up**, **Down**, **Left**, and **Right** Cursor Keys.

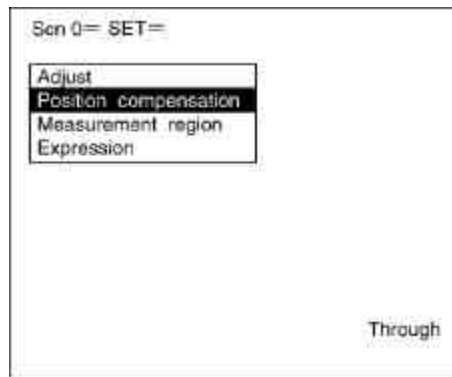

- 2 Press the **ENT** Key.
In this example, the cursor will move to the **Adjust** menu. Repeat this step to move to lower levels.

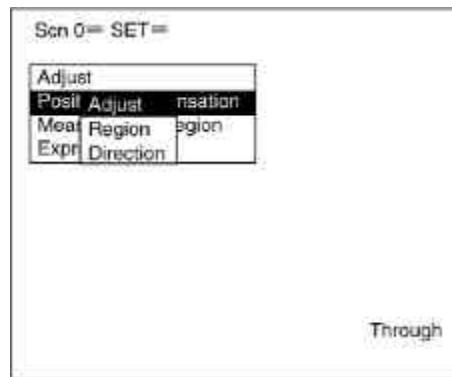

- 3 Press the **ESC** Key.
The display will move to the previous menu level (here, the screen shown in step 1).

2-2-4 Inputting Values

This section explains how to input numerical values when setting measurement conditions.

This procedure is mainly used for setting judgement conditions and system conditions.

- 1 Move the cursor to the item for which a value is to be changed and press the **ENT** Key.
The cursor size will change to a cursor the size of a single digit.

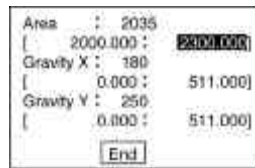

- 2 Using the **Left** and **Right** Keys, move the cursor to the digit to be changed.

[2000.000: 0002█00.000]

- 3 Use the **Up** and **Down** Keys to change the value.
(Repeat steps 2 and 3 to change other digits as required.)

[2000.000: 00025█00.000]

- 4 Press the **ENT** Key when all digits have been changed as desired.
The value will be set.

[2000.000: ██████]

2-2-5 Triangle Mark

Items with an inverted triangle after them have a list of alternatives. Select one of these items when making settings. The selection method is given here.

1 Move the cursor to the item to be set.

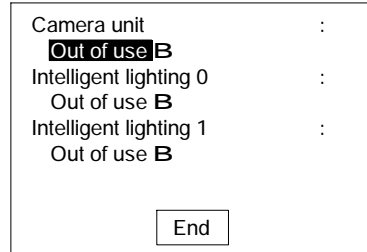

2 Press the **ENT** Key.
The selections will be displayed.

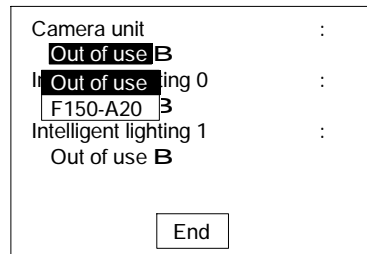

3 Move the cursor to the desired selection using the **Up** and **Down** Keys.

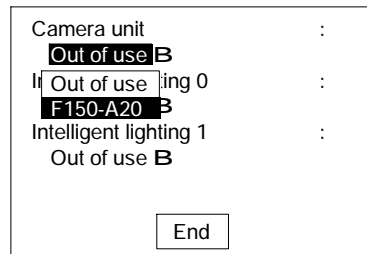

4 Press the **ENT** Key to enter the setting.

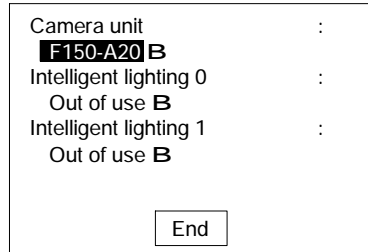

2-2-6 Drawing a Region

Use the following method to draw model regions and measurement regions. Create the required shape by moving the cursor with the **Up**, **Down**, **Left** and **Right** Keys and pressing the **ENT** Key at the desired positions. Use together with the **SHIFT** Key to move the cursor quickly.

Types of Figure

Type of figure	Drawing method
Box	Specify 2 opposite corners.
Ellipse	Specify 2 opposite corners for the circumscribed rectangle of the ellipse.
Circle	Specify the center and the radius.
Circumference	Specify the center, radius, and thickness.
Polygon	Specify up to 10 neighboring vertices. At the last point, press the ENT Key twice and the last point will be joined to the first point and the figure will be drawn.

The type and number of regions that can be drawn, depend on the measurement method.

Drawing Mode

Drawing mode	Function
OR	Use this mode to draw a shape as a model or measurement region.
NOT	Use to delete part of a region.

As an example, the following diagram shows how to draw a measurement region with the central part removed. Draw figure 1 in

OR mode and then draw figure 2 in NOT mode. Measurement will only be performed for the outer band.

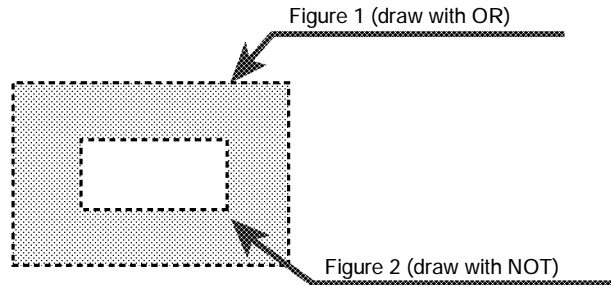

2-3 Two-camera Unit

Using the Two-camera Unit, two Cameras can be connected to the F150 enabling images to be obtained simultaneously.

Synchronized Images from Different Directions

Checking Boxes from Both Ends

Measurement can be performed for boxes from both ends simultaneously using two Cameras.

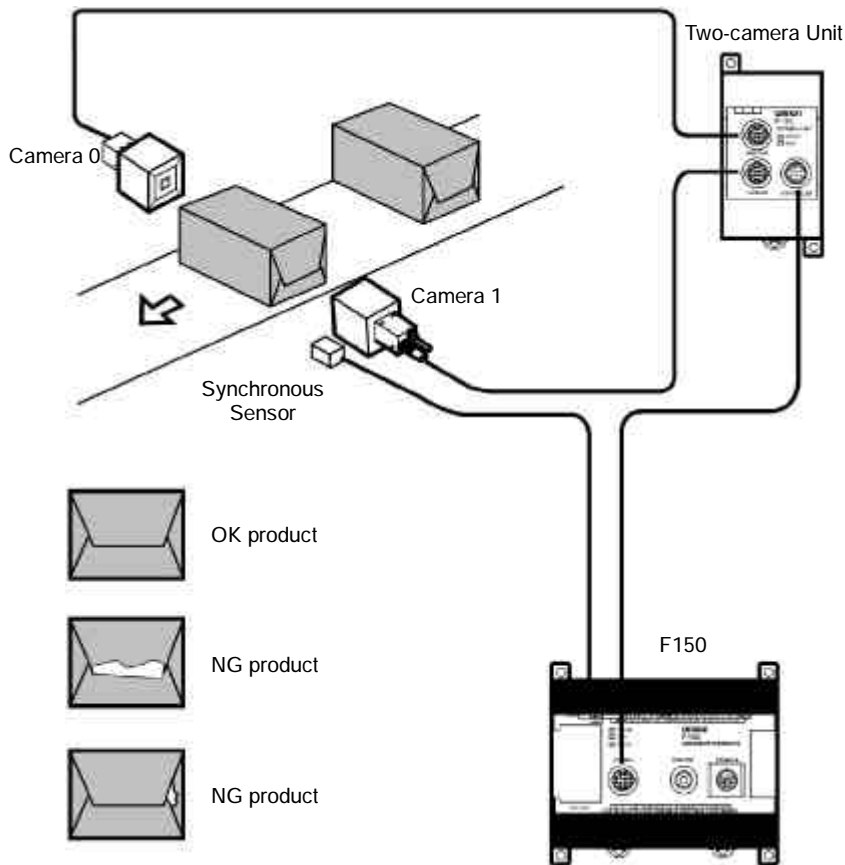

Mutual Light-interference Prevention Function

If the Camera with Intelligent Light Source (F150-SLC20/SLC50) or the Camera with Light Source (F150-SL20A/SL50A) is used, there is a slight difference in the time at which the light sources for the respective Cameras come ON (first Camera 0 then Camera 1). Therefore, there is no mutual light interference.

Measuring Large Objects with One Controller

Positioning PWB Using two Cameras, the field of vision can be split in two and the coordinates of positioning markings can be obtained.

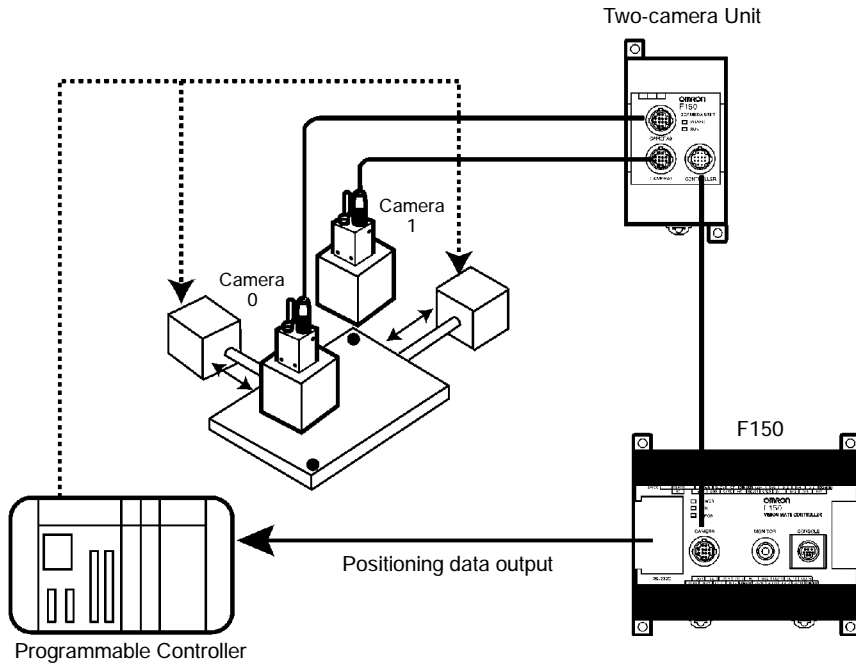

Measurement processing can be performed on images obtained by joining Camera 0 images and Camera 1 images. This means that the image required can be obtained in the time it usually takes to obtain one normal image. (In Horizontal Composition mode 1, however, an extra 8.3 ms is required.)

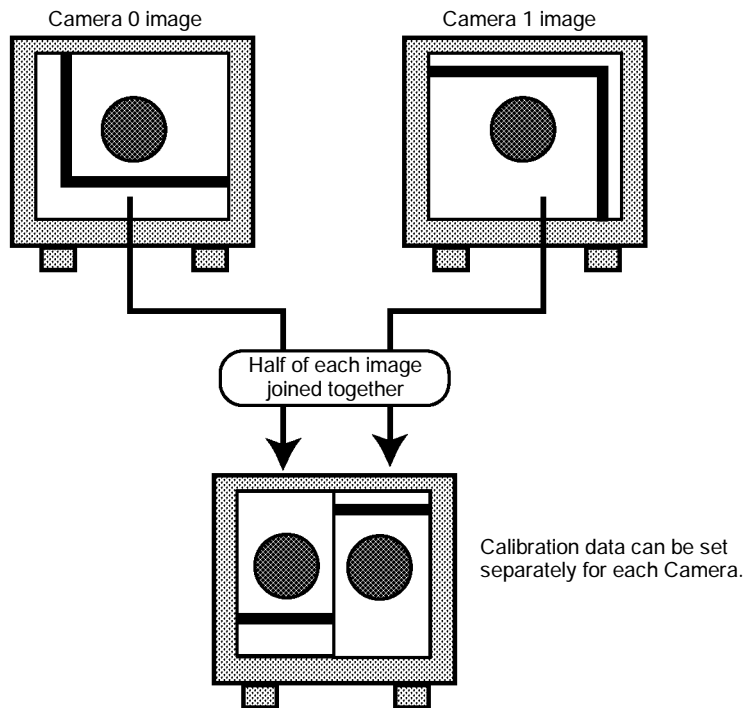

2-3-1 Two-camera Unit Menu

The default menu configuration for the F150 is for one-camera operation. For two-camera operation it is necessary to change to the two-camera menu configuration. This is done by changing the **Camera unit** setting in **SYS/Device settings**.

Procedure

- 1** Display the Basic Screen, move the cursor to **MON**, and press the **ENT** Key.

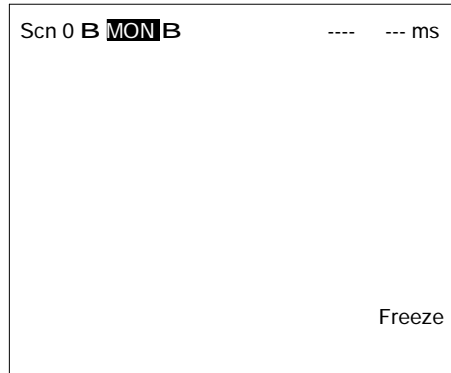

- 2** Select **SYS**.

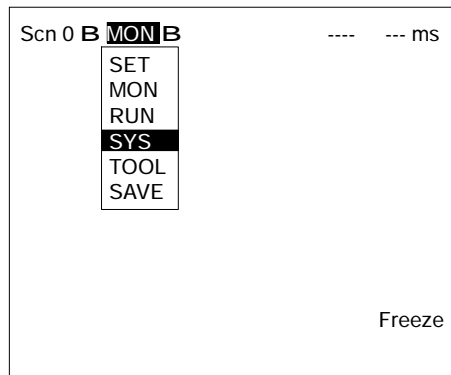

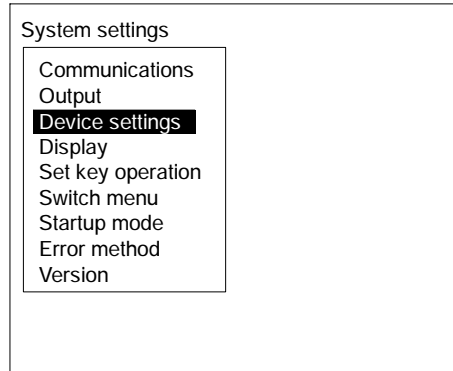
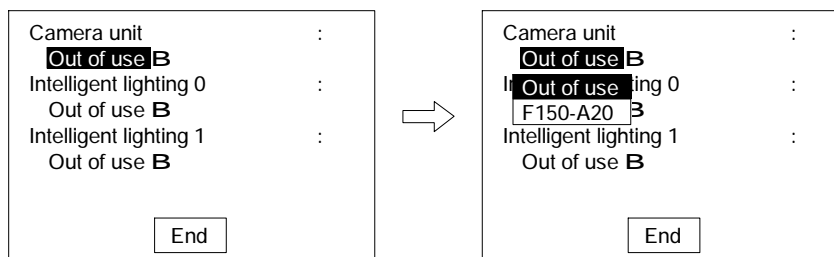
3 Select *Device settings*.**4** Move the cursor to *Camera unit* and press the **ENT** Key. The selections will be displayed.

Select **F150-A20** using the **Up** and **Down** Keys, and press the **ENT** Key to enter the setting.

5 Select *End*.

The screen for step 3 will be returned. Press the **ESC** Key to return the Basic Screen shown in step 1.

2-3-2 Camera Modes

When entering Set mode for the first time after the making the settings in **SYS/Device settings**, the screen for selecting the camera mode will be displayed. The menu configuration varies with the camera mode selected as shown below.

Refer to the following page for details on camera modes: → **p. 38**

Refer to the following page for details on changing camera modes after settings have been made: → **p. 40**

Procedure

1 Move the cursor to **MON** and press the **ENT** key.

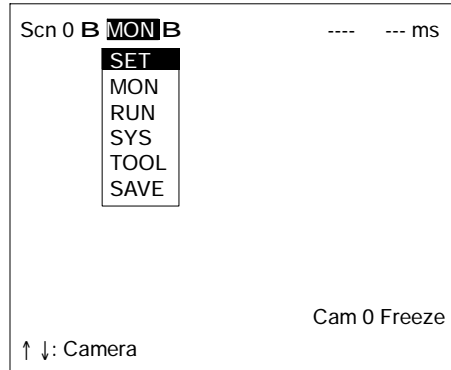

2 Select **SET**.

The screen for selecting the camera mode will be displayed.

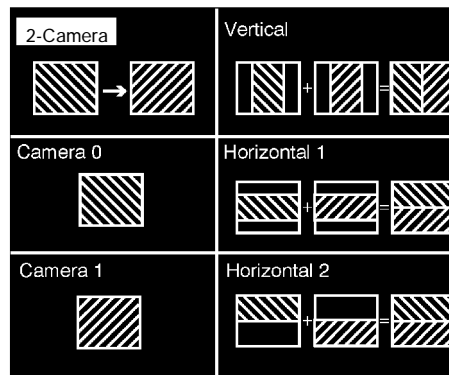

If the screen display goes directly into Set mode without the screen for selecting the camera mode being displayed, display this screen by pressing the **SHIFT + ENT** Keys together.

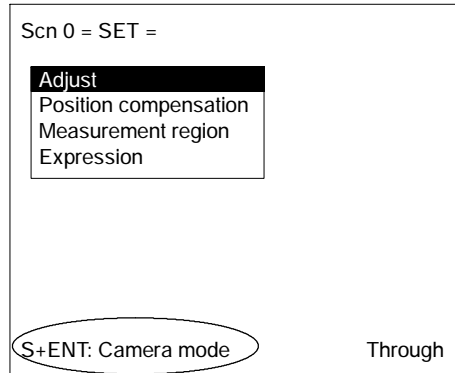

- 3** Select the camera mode.
The screen for Set mode will be displayed with the menu configuration for the camera mode selected.

Menu Configuration for Two-camera Operation

If a two-camera operation mode (Two-camera Switching mode, Vertical Composition mode, or Horizontal Composition mode 1 or 2) is selected, the following screen will be displayed.

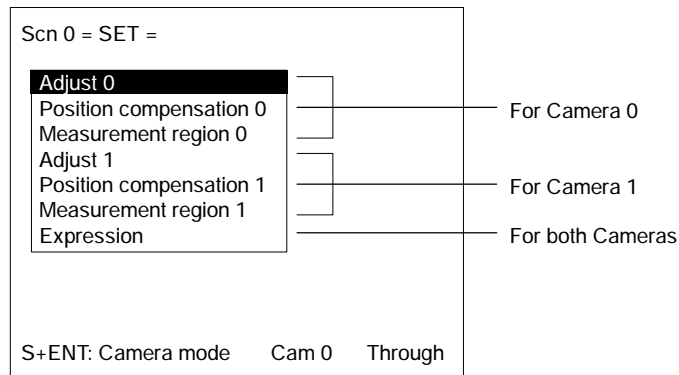

Camera 0 Mode, Camera 1 Mode

If Camera 0 mode or Camera 1 mode is selected, the following screen will be displayed.

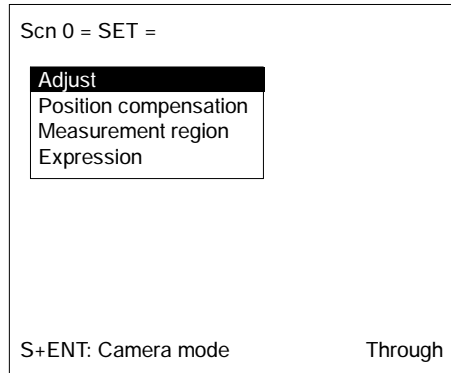

The procedures for these modes are the same as when only one Camera is connected to the F150.

In subsequent explanations, notes (under "Two-camera Operation") have been added in places where there are differences in procedures for one-camera operation (i.e., when only one Camera is connected, or when the camera mode is Camera 0 mode or Camera 1 mode) and procedures for two-camera operation (i.e., the camera mode is Two-camera Switching mode, Vertical Composition mode, or Horizontal Composition mode 1 or 2).

Camera Modes

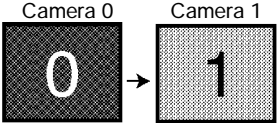
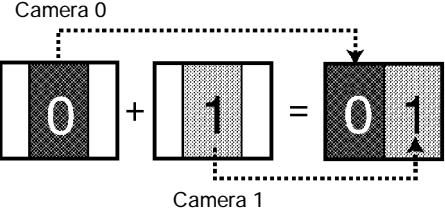
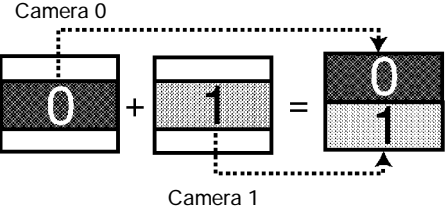
Camera mode	Screen image	Operation
Two-camera Switching		<p>With one trigger execution, images are obtained simultaneously by both Cameras and measurement is performed on these images in order (Camera 0 → Camera 1). Computations combining data from both Cameras are possible. (There are 8 measurement regions for each Camera.)</p>
Vertical Composition		<p>With one trigger execution, half of Camera 0's image and half of Camera 1's image are combined and measurement is performed on this image. Even though two Cameras are used, the time taken to obtain the joined image is the same as for one Camera and so processing time is reduced.</p>
Horizontal Composition 1		<p>The central parts of horizontally partitioned images are joined. In this mode, the image input time is 8.3 ms longer than the time required for one Camera to take an image. Only the central parts of images are used, however, allowing simple Camera installation.</p>

Camera mode	Screen image	Operation
Horizontal Composition 2	<p>Camera 0</p> <p>Camera 1</p>	<p>The top half of one Camera's image is joined with the bottom half of the other Camera's image. The image input time is the same as for one Camera. Although the processing time is less than that for Horizontal Composition mode 1, since the top and bottom halves of images are joined, adjustment of the Camera position is required.</p>
Camera 0		<p>With one trigger execution, an image is obtained with Camera 0 and measurement is performed on that image. Even if another Camera (Camera 1) is connected, its image will not be input. (See note.)</p>
Camera 1		<p>As with Camera 0 mode, with one trigger execution, an image is obtained with Camera 0 and measurement is performed on that image. (See note.)</p>

Note The camera mode can be specified as part of scene data. For example, Camera 0 mode can be specified as the camera mode for scene 0 and Camera 1 mode can be specified as the camera mode for scene 1. When either of the one camera modes are used, up to 16 measurement regions can be specified.

Changing Camera Mode

Press the **SHIFT + ENT** Keys in Set mode to display the screen for changing the camera mode.

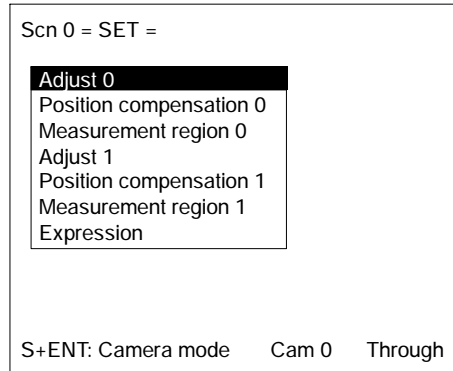

Changing from Two-camera Operation to One-camera Operation

When changing from Two-camera Switching mode, Vertical Composition mode, or Horizontal Composition mode 1 or 2 to Camera 0 mode or Camera 1 mode, information for the Camera that is selected will be held, and information for the other Camera will be cleared.

Example

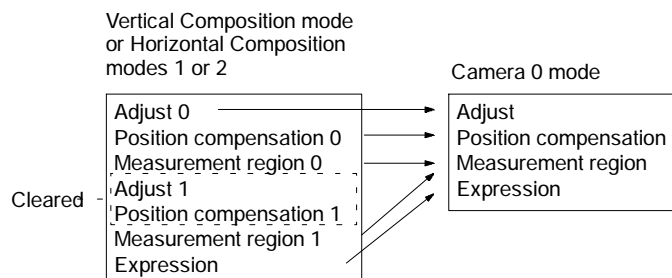
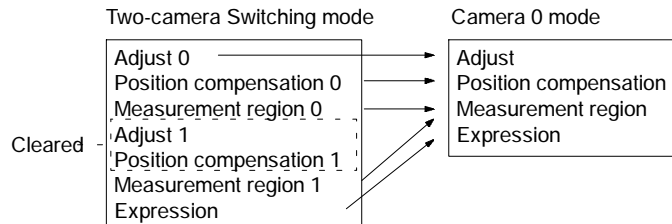

Changing from One-camera Operation to Two-camera Operation

When changing from Camera 0 mode or Camera 1 mode to Two-camera Switching mode, Vertical Composition mode, or Horizontal Composition mode 1 or 2, information for the original Camera mode is held.

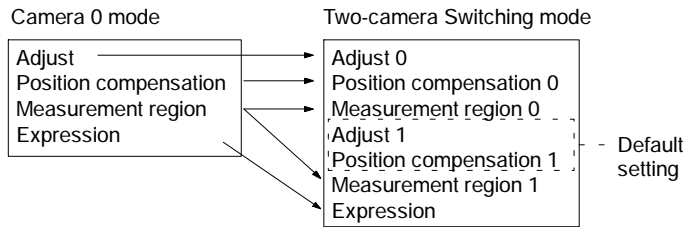

Note After setting the measurement conditions for operation with just one Camera connected, if a Two-camera Unit is connected and the settings in **SYS/Device settings** are changed accordingly, Camera 0 mode will be selected automatically, and the same measurement conditions will be used.

2-4 Intelligent Light Source

In order to adjust the light level when using an Intelligent Light Source, it is necessary to specify the Intelligent Light Source model connected. This setting is performed in **SYS/Device settings**.

Procedure

- 1 Display the Basic Screen, move the cursor to **MON**, and press the **ENT** key.

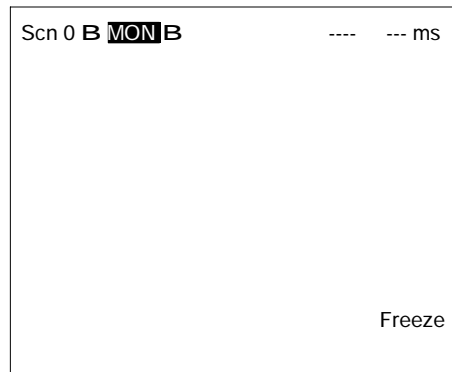

2 Select **SYS**.

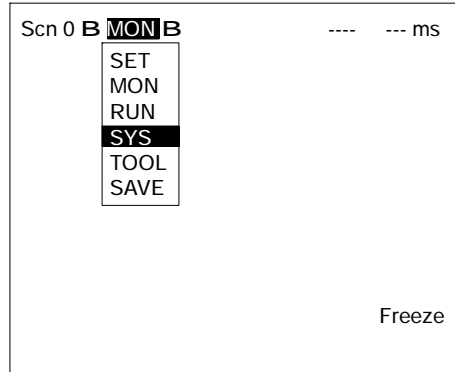

3 Select **Device settings**.

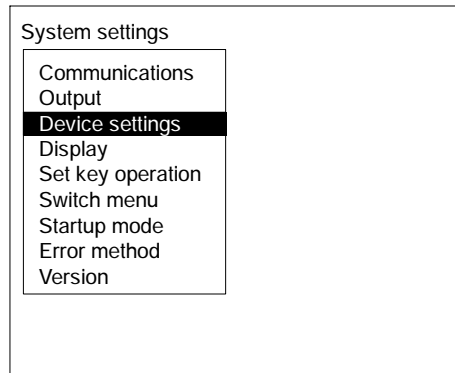

4 Move the cursor to **Intelligent lighting 0 (or 1)** and press the **ENT** Key.
The model selections will be displayed.

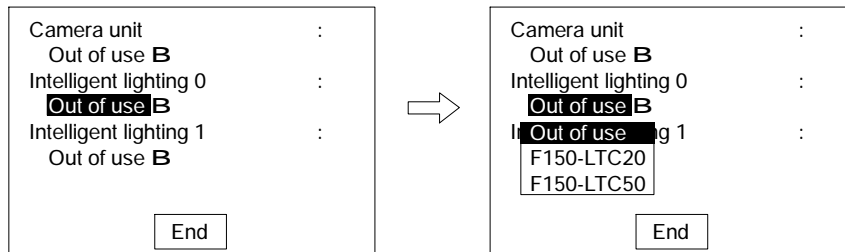

Select the model of the Intelligent Light Source connected using the **Up** and **Down** Keys, and press the **ENT** key to enter the set-

ting. The model number of the Intelligent Light Source itself is selected. Therefore, when a Camera with Intelligent Light Source is connected, make the settings shown below.

- If the F150-SLC20 is used, select **F150-LTC20**.
- If the F150-SLC50 is used, select **F150-LTC50**.

5 Select **End**.

The screen from step 3 will be returned. Press the **ESC** Key to return the Basic Screen shown in step 1.

Note There are DIP switches on the Intelligent Light Sources for setting the unit number. Set the unit number for the Intelligent Light Source connected to Camera 0 to 0 and set the unit number for the Intelligent Light Source connected to Camera 1 to 1. The DIP switch setting for the Intelligent Light Source for Camera 1 is shown below.

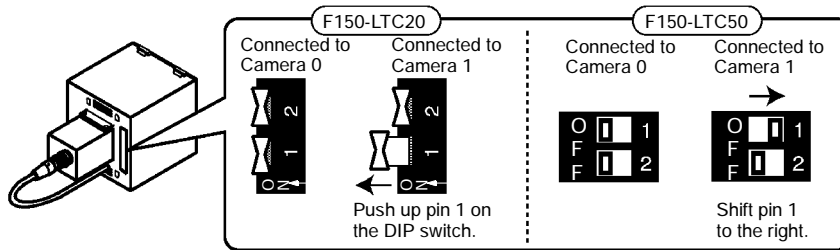



SECTION 3

Setting Measurement Conditions

This section describes the settings required for F150 operation.

3-1	Entering Set Mode	46
3-2	Adjusting Images	47
3-2-1	Shutter Speed	47
3-2-2	Filtering	48
3-2-3	Background Suppression	49
3-2-4	Output Calibration	50
3-2-5	Adjusting Light Level	59
3-3	Position Displacement Compensation	62
3-3-1	Adjusting the Image for Easier Position Displacement Compensation	64
3-3-2	Setting Position Displacement Compensation Regions	65
3-3-3	Selecting the Direction for Position Displacement Compensation	77
3-3-4	Changing Settings or Clearing	79
3-4	Drawing Measurement Regions and Setting Evaluation Criteria	80
3-4-1	Selecting Region Number	80
3-4-2	Binary Center of Gravity and Area and Axis Angle	82
3-4-3	Gray Edge Position	91
3-4-4	Edge Pitch	95
3-4-5	Gray Search and Precise Search	98
3-4-6	Surface Defect	105
3-4-7	Density Averaging	108
3-4-8	Relative Search	112
3-4-9	Changing Settings or Clearing	120
3-5	Output Expressions	122
3-6	Scenes	132
3-6-1	Changing Scenes	132
3-6-2	Copying Scene Data	134
3-7	Initializing Measurement Conditions (Clearing Scenes)	135

3-1 Entering Set Mode

To set the measurement conditions, it is first necessary to enter Set mode.

Note When a Two-camera Unit or an Intelligent Light Source are connected, make the required settings in *SYS/Device settings* before entering Set mode. → p. 32, 41

Procedure

1 Display the Basic Screen, move the cursor to **MON**, and press the **ENT** key.

2 Select **SET**.

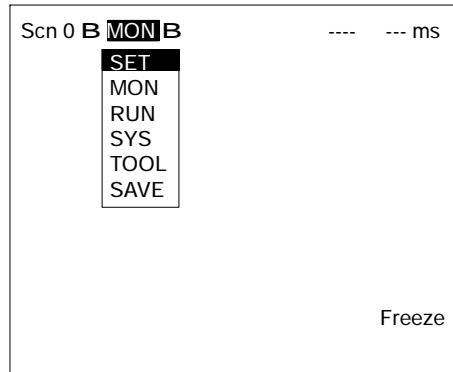

The Basic Screen for Set mode will be displayed.

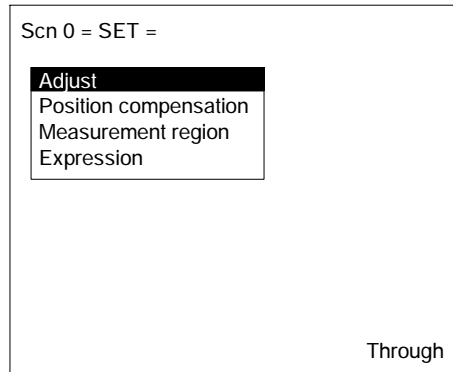

Two-camera Operation

If the Two-camera Unit is connected, select the camera mode when entering Set mode. → p. 34

3-2 Adjusting Images

Two-camera Operation If two Cameras are used, **Adjust 0** for Camera 0 and **Adjust 1** for Camera 1 will be displayed. → p. 36

3-2-1 Shutter Speed

Change the shutter speed when the object is moving quickly, causing the image to be blurred.

Object movement Shutter speed

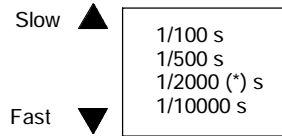

* Default setting

Two-camera Operation If two Cameras are used, the setting for shutter speed in **Adjust 0/Shutter speed 01** will be used for both Cameras.

Procedure

1 Go to **Adjust/Shutter speed**.

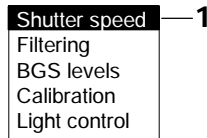

2 Select the shutter speed while monitoring the image.

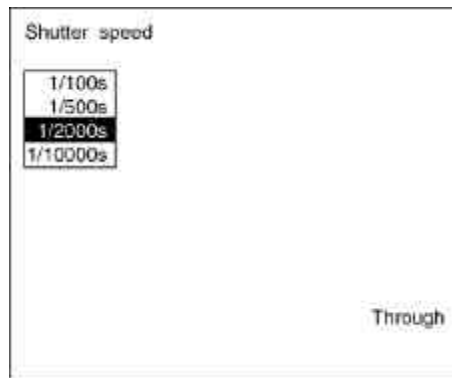

3 Press the **ENT** Key to enter the setting.

3-2-2 Filtering

The image read by the Camera can be manipulated to create an image that is easier to measure, by using smoothing or edge enhancement.

Smoothing displays a smoothed image with reduced noise. Smoothing allows suppression of the effects of uneven lighting due to an uneven or damaged surface.

Edge enhancement displays an image with enhanced edges between bright and dark regions to compensate for blurred images.

The cursor can be moved on the image to see the effects of filtering.

Filtering method	Function
OFF	No filtering.
Smoothing	Displays a smooth image with reduced noise. Select either weak or strong smoothing.
Enhance edges	Displays an image with enhanced edges between bright and dark regions.
Extract edges	Displays an image with the edges between the bright and dark regions extracted.

Note The filtering set here is used for object measurement. Filtering can be set separately for position displacement compensation. → p. 64

Two-camera Operation

If the camera mode is Vertical Composition mode or Horizontal Composition mode 1 or 2, the filtering setting in **Adjust 0/Filtering 01** will be used for both Cameras.

Procedure

- 1 Go to **Adjust/Filtering**.

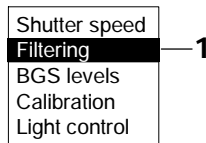

2 Select the filtering method while monitoring the image.

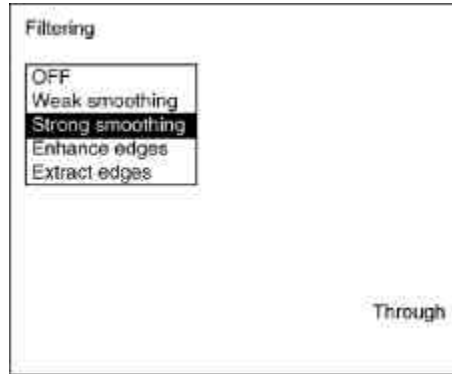

3 Press the **ENT** Key to enter the setting.

3-2-3 Background Suppression

Background suppression (BGS) excludes the background of the measurement object from the measurement process.

BGS changes image areas with densities below the lower limit to 0, and image areas with densities above the upper limit to 255. Image areas with densities between the lower and upper limits are graded from 0 to 255 so that only images with densities between the lower and upper limits are measured.

Look at the image and set the upper and lower limits of the density to eliminate the background.

Example

Lower limit: 150

Upper limit: 255

Measurement object

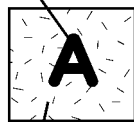

Background

Density

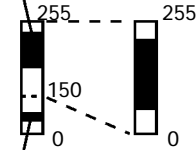

Background density (cut)

Image areas with densities of 149 or lower will not be measured and the density will be changed to 0.

Only image areas with densities between 150 and 255 will be measured. The whole image is graded from 0 to 255.

Note The BGS levels set here are used for object measurement. BGS levels can be set separately for position displacement compensation. → **p. 64**

Two-camera Operation

If the camera mode is Vertical Composition mode or Horizontal Composition modes 1 or 2, the BGS levels set in **Adjust 0/BGS Levels 01** will be used for both Cameras.

Procedure

- 1 Go to **Adjust/BGS levels**.

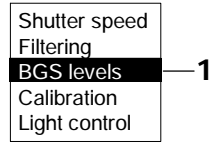

- 2 Move the cursor to the upper-limit value and use the **Left** and **Right** Keys to decrease or increase the value. Press the **Right** Key to increase the smallest digit by 1 (use with **SHIFT** Key to increase by 10). Press the **Left** Key to decrease the smallest digit by 1 (use with **SHIFT** Key to decrease by 10).
- 3 Repeat the previous step to change the lower limit.
- 4 Select **OK** to exit this screen.

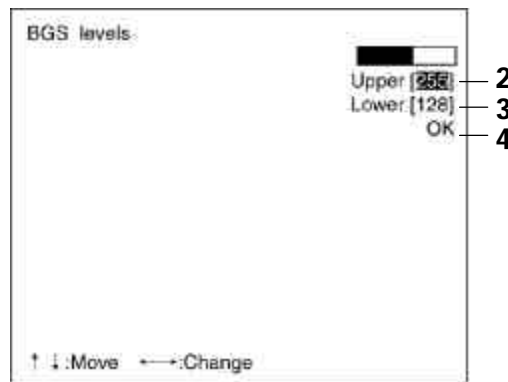

3-2-4 Output Calibration

Calibration can be set to output the measurement results in physical units, such as mm.

Set the relationship between the physical coordinates and the camera coordinates to convert the measurement results from pixels to physical units, such as μm , mm, or cm.

If calibration data is not set, the default settings will remain, and measurements using the camera coordinates will be output.

Default Settings

- Coordinate system: Left-handed system
- Origin: Upper left corner of screen

- Magnification: 1.000
- Unit: mm/pix

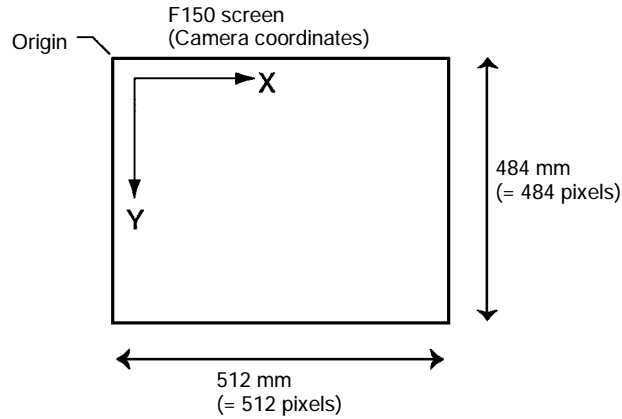

There are 2 settings for calibration: "Sampling" and "Parameter input."

Two-camera Operation

Calibration can be set separately for each Camera. The setting for Camera 0 is in **Adjust 0/Calibration 0** and the setting for Camera 1 is in **Adjust 1/Calibration 1**.

Sampling

Register a model, and perform a sample measurement. Enter the physical coordinates of the position of the model. The calibration will be calculated automatically. Sample measurements can be made in up to 3 places.

- When the magnifications are the same for the X and the Y directions, make sample measurements in 2 places only.

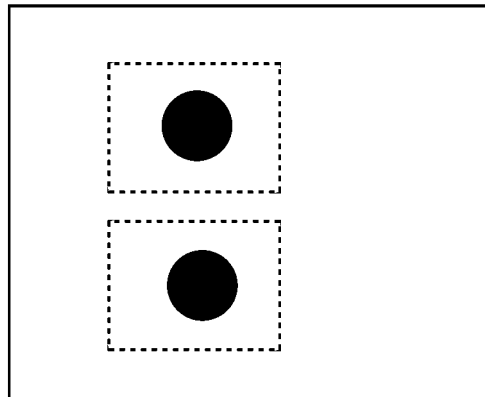

- When the magnifications in the X and Y directions are different, perform sampling measurement in 3 places.

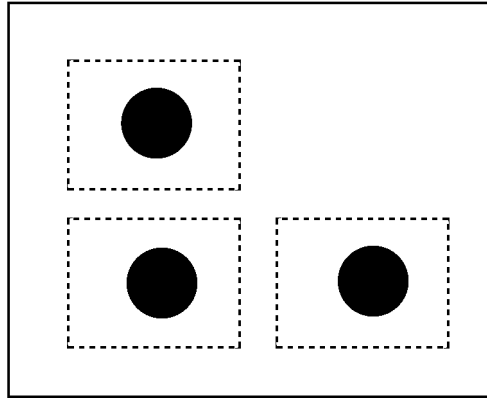

Procedure

1 Go to **Adjust/Calibration**.

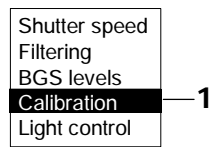

2 Select **Model registration**.

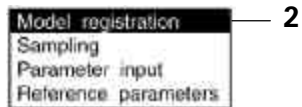

3 Register the model image to be used for sampling.

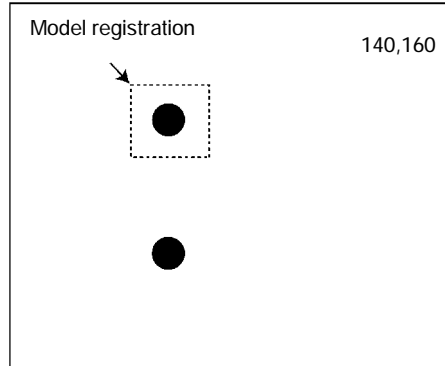

4 Select **Sampling**.

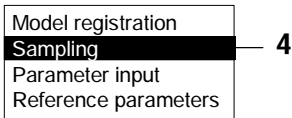

5 Draw the sampling region.

Press the **SHIFT + ENT** Keys to display the screen for changing the size and position of the region.

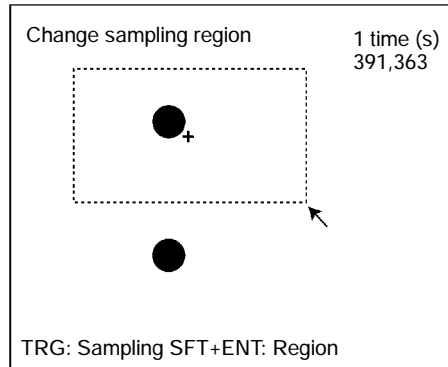

- 6 Press the **TRIG** Key to execute sampling.
A cross and a frame will appear at the position where the model is found, and the screen for inputting the physical coordinates will be displayed.
Refer to the following page for details on inputting values:
→ p. 26

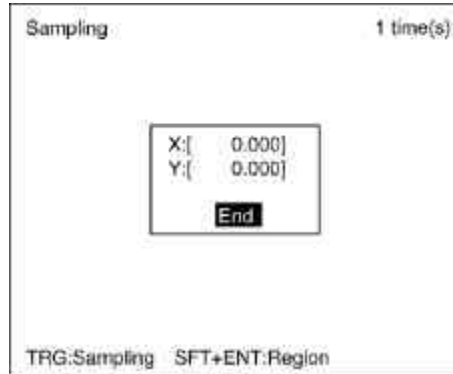

Note If Image Not Found

If the brightness varies with the position, the correlation with the model will be low. In this case, it may not be possible to find the image for sampling. Adjust the lighting so that the image is illuminated evenly. Take particular care when the direction of illumination has been changed using an Intelligent Light Source.

- 7 Enter the physical coordinates of the center of the model (the position of the cross) and select **End**.
The screen from step 5 will be returned.
- If a mistake is made, press the **SHIFT + ESC** Keys and repeat the previous sampling operation.
- By repeating steps 5 to 7, make samples for the required number of places.
- When making samples in 2 places, press the **ESC** Key after the second sampling. A registration confirmation message will be displayed.
 - When making samples in 3 places, a registration confirmation message will be displayed after the third sampling.

8 Select *Execute*.

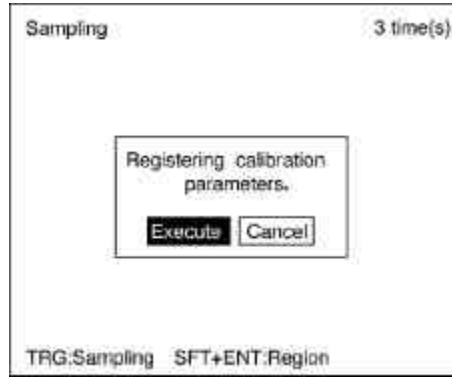

Parameter Input

Use the following procedure to directly input parameters to be used for calibration.

• **Origin**

Specify the physical coordinates for the position of the origin as desired.

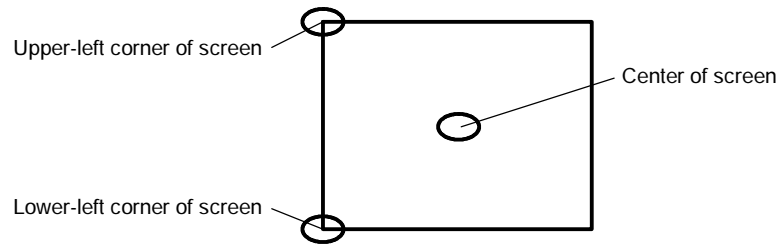

• **Coordinate System**

Select the coordinate system for the physical coordinates.

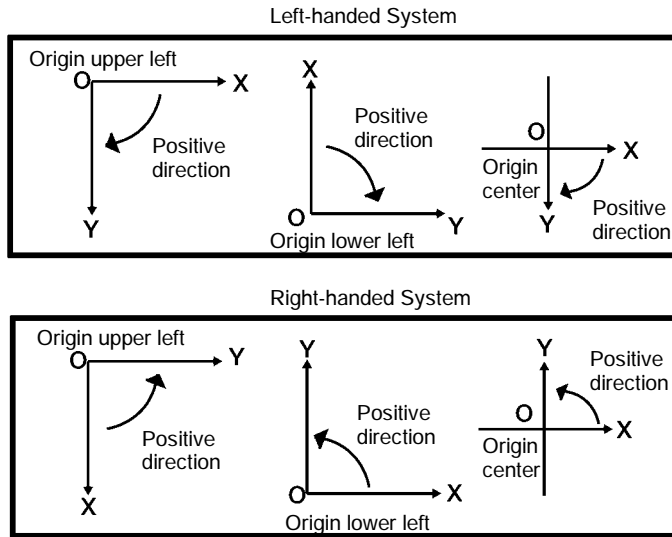

• **Magnification and Units**

Set the physical unit that will correspond to one pixel. Set a value in the range 0.010 to 9.999 for the magnification. Choose a unit from μm , mm, or cm.

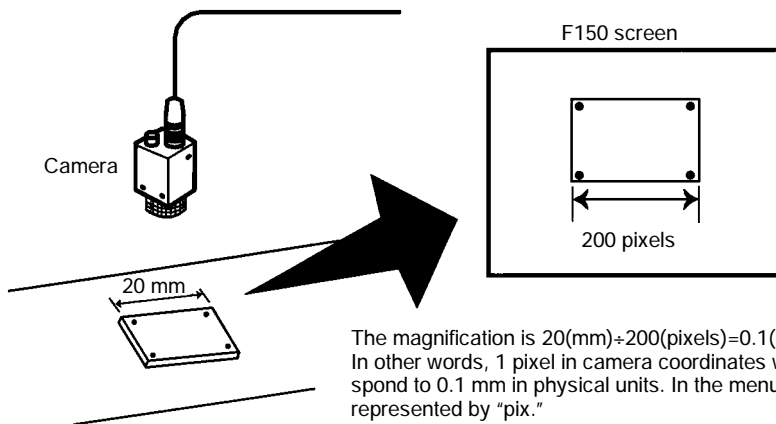

Procedure

1 Go to **Adjust/Calibration**.

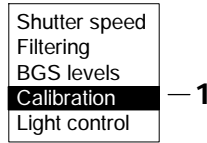

2 Select **Parameter input**.

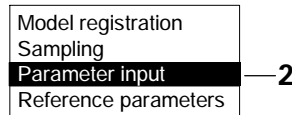

3 Set the items.

Refer to the following page for details on inputting values:

→ **p. 26**

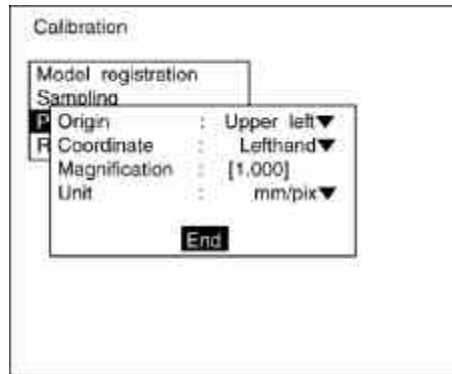

4 Select **End** to enter the settings.

Reference Parameters

This screen is used to check data settings.

The symbol, σ , represents the error standard deviation. It is the standard deviation value of the difference between the physical coordinates input for calibration settings and the coordinates after conversion based on the calculated conversion values A to F. It is calculated according to the following formula:

$$\sigma = \sqrt{\frac{1}{N} \sum_{i=1}^N ((RX_i - X_i)^2 + (RY_i - Y_i)^2)}$$

(RX_i,RY_i): Physical coordinates input for calibration settings (i=1 to N).
 (X_i,Y_i): Physical coordinates after conversion according to the conversion values (i=1 to N).
 N: Data number (sampling places 1 to 3)

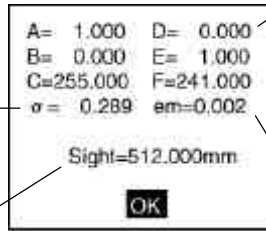

A to F represent the calibration conversion values. The camera coordinates are converted to physical units based on these calibration conversion values. The formulae for conversion to physical units are as follows:
 $X' = A \times X + B \times Y + C$
 $Y' = D \times X + E \times Y + F$

(X,Y): measurement position (camera coordinates), unit: pixels

(X',Y'): conversion position (physical coordinates), units: mm

Indicates physical width (in X direction) of screen.

"em" indicates the maximum error. It is the largest value of the differences between the physical coordinates input for calibration settings and the coordinates after conversion based on the calculated conversion values A to F. It is calculated according to the following formula:

$$em = \text{MAX} \sqrt{(RX_i - X_i)^2 + (RY_i - Y_i)^2}$$

MAX: Outputs the largest value of the expression for values (i = 1 to N).
 (RX_i,RY_i): Physical coordinates input for calibration settings (i = 1 to N).
 (X_i,Y_i): Physical coordinates obtained after conversion based on the conversion values (i = 1 to N).
 N: Data number (sampling places 1 to 3)

Procedure

1 Go to **Adjust/Calibration**.

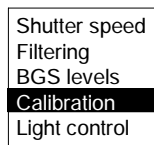

2 Select **Reference parameters**. The parameters will be displayed.

3 Select **OK** to exit this screen.

3-2-5 Adjusting Light Level

The light level of Intelligent Light Sources can be adjusted from the F150. Before using an Intelligent Light Source, be sure to change the settings in **SYS/Device settings**. → p. 41

Two-camera Operation

The light level for Intelligent Light Sources can be set separately for Camera 0 and Camera 1. Make the settings for Camera 0 and Camera 1 in **Adjust 0/Light control 0** and **Adjust 1/Light control 1** respectively.

Sample Lighting Pattern

There are 15 lighting patterns registered with the F150. The lighting can be set simply by going through the different patterns in order and selecting the one that gives the clearest image.

Pattern number	F150-LTC20		F150-LTC50	
	Contents	Light level	Contents	Light level
1	Center	50000	All	77777777
2	Rim (weak)	03333	Inside (weak)	44440000
3	Rim (strong)	07777	Inside (strong)	77770000
4	Top and bottom only	07070	Outside (weak)	00004444
5	Top and bottom emphasized	27272	Outside (strong)	00007777
6	Left and right only	00707	Top and bottom	70707070
7	Left and right emphasized	22727	Left and right	07070707
8	Top	07000	Inside top	70000000
9	Right	00700	Inside right	07000000
10	Bottom	00070	Inside bottom	00700000
11	Left	00007	Inside left	00070000
12	Center strong, rim very weak	51111	Outside top	00007000
13	Center strong, rim weak	52222	Outside right	00000700
14	Center very weak, rim strong	17777	Outside bottom	00000070
15	Center weak, rim strong	27777	Outside left	00000007

Adjusting Light Level Separately

The light level for each section can be set separately to a value between 0 and 7. The setting "0" represents the unlit state, and the higher the setting value the higher the light level. Light levels can also be set by adjusting the light levels for the sections separately after selecting a sample lighting pattern.

F150-LTC20 (Field of Vision: 20 mm)

The light level can be adjusted in 5 sections. The light level is indicated on the screen by a 5-digit number. Each digit represents the light level of one of the 5 sections.

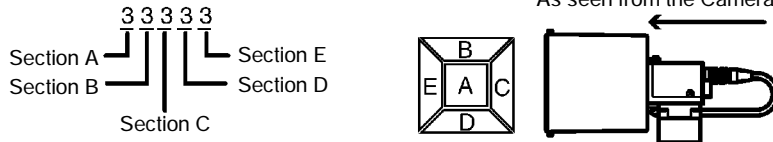

F150-LTC50 (Field of Vision: 50 mm)

The light level can be adjusted in 8 sections. The light level is indicated on the screen by an 8-digit number. Each digit represents the light level of one of the 8 sections.

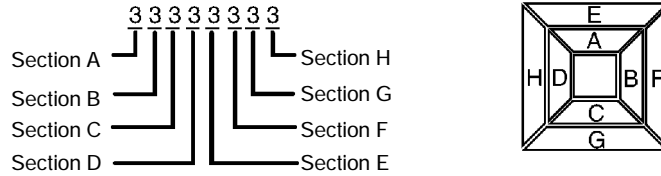

Procedure

- 1 Select **Adjust/Light control**.

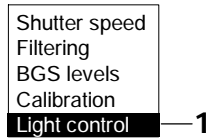

2 Switch sample patterns using the **SHIFT + Left/Right** Keys.

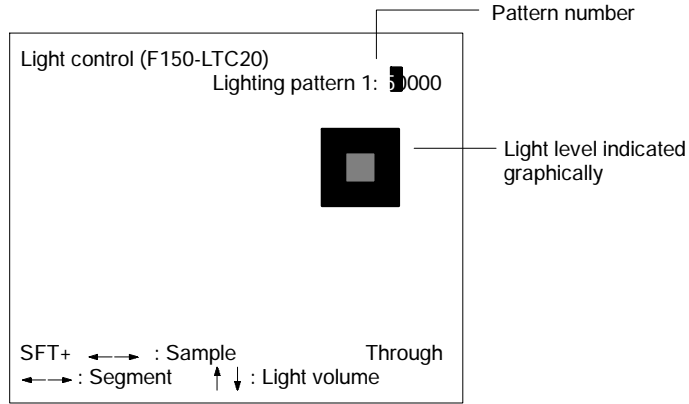

3 For fine adjustment of light levels, move to the desired digit using the **Right** and **Left** Keys.

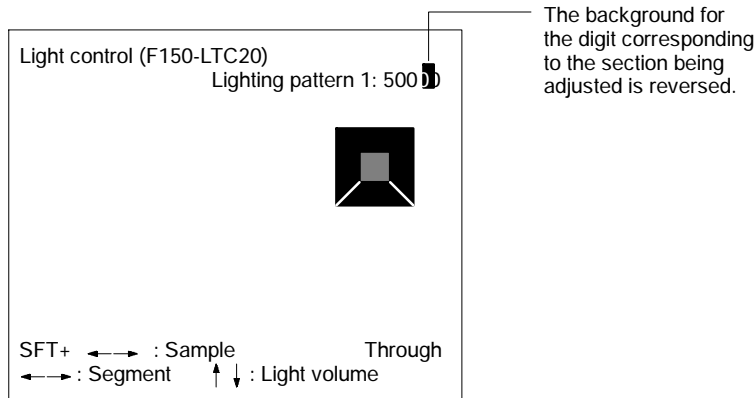

4 Change the light level using the **Up** and **Down** Keys.

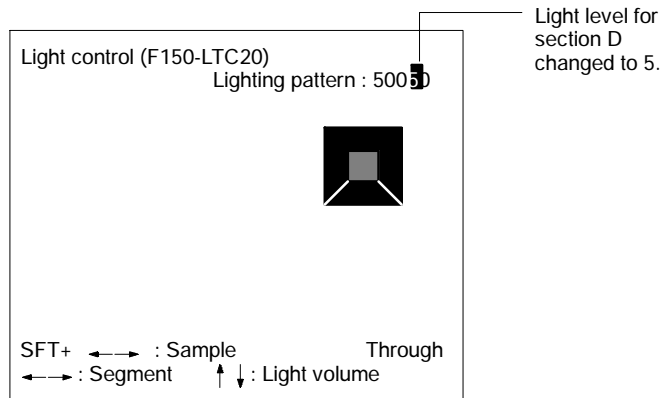

5 Press the **ENT** Key to enter the setting.

3-3 Position Displacement Compensation

The following functions are available for position displacement compensation:

- Adjust: Adjusts images to make position displacement compensation easier.
- Region: Sets the regions and methods used for position displacement compensation:
 - Gravity and area.
 - Gravity and axis angle
 - Gray edge position
 - Gray search
 - Change/clear settings
- Direction: Sets the direction for position displacement compensation.

The position displacement compensation function is used when the position and orientation of measurement objects are not consistent. By using this function, the displacement between the reference position and the current position is obtained, and this displacement is compensated for in measurements.

Reference Position

The measurement region and measurement object are in the correct positions.

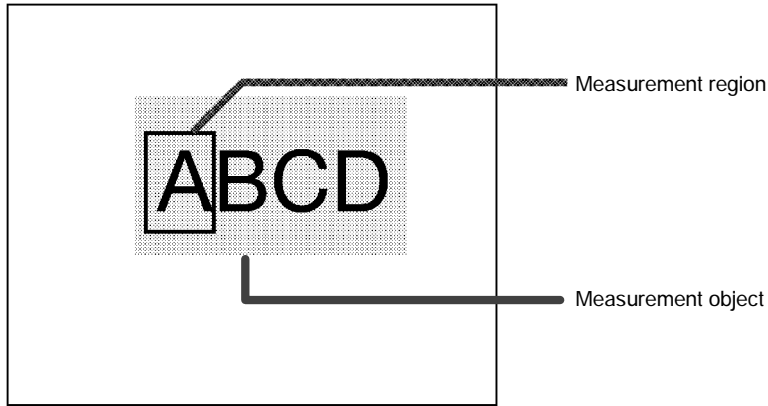

Measurement Object Displaced

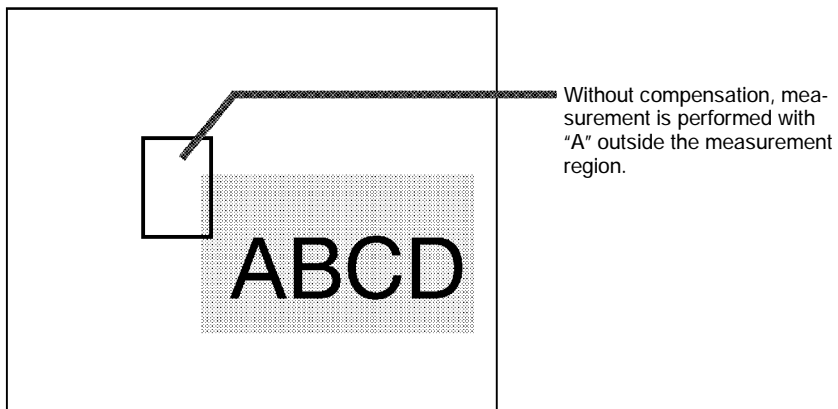

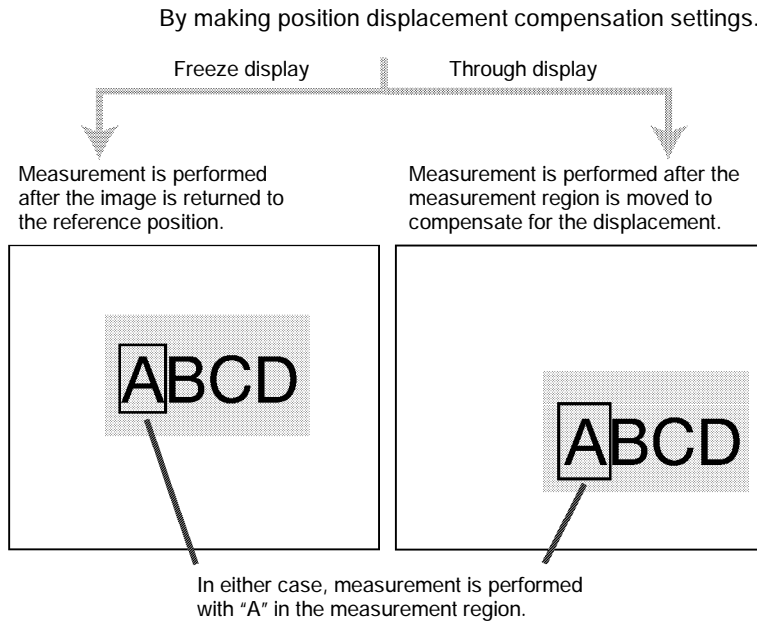

Two-camera Operation If two Cameras are used, **Position compensation 0** for Camera 0 and **Position compensation 1** for Camera 1 are displayed.

3-3-1 Adjusting the Image for Easier Position Displacement Compensation

Filtering

A different kind of filtering is used for position displacement compensation to that used for ordinary measurement.

- For measurement: Smoothing is used to reduce noise.
- For position displacement compensation: Edges are enhanced to make the shape of the measurement object clearer.

The operating procedure, however, is the same as for ordinary measurement. → p. 48

Background Suppression

A different level of background suppression is used for position displacement compensation to that used for ordinary measurement. The operating procedure, however, is the same as for ordinary measurement. → p. 49

Two-camera Operation If the camera mode is Vertical Composition mode or Horizontal Composition mode 1 or 2, the settings for filtering and back-

ground suppression in **Position compensation 0/Adjust 01** will be used or both Cameras.

Two-camera Operation If the camera mode is Two-camera Switching mode, there is an **Adjust** menu in both **Position compensation 0** and **Position compensation 1** and so separate filtering and background suppression settings can be made for each Camera.

3-3-2 Setting Position Displacement Compensation Regions

1 Select **Position compensation**.

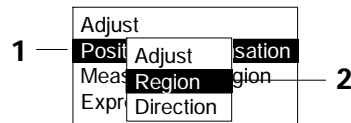

2 Select **Region**.

The screen for selecting the region number will be displayed.

Press the **SHIFT + ESC** Keys to reverse (dark ↔ clear) the background.

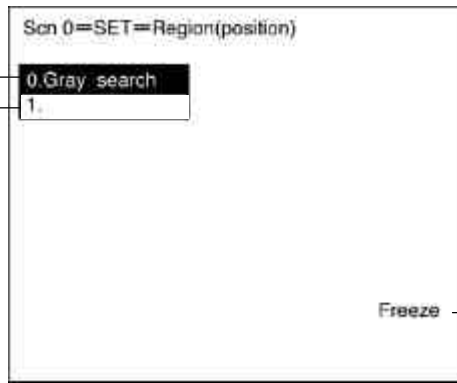

Press the **SHIFT** Key together with the **Up/Down** Key to switch display images. → p. 164

Two-camera Operation

If two Cameras are used, regions 0 and 1 will be displayed for **Position compensation 0** and regions 10 and 11 will be displayed for **Position compensation 1**.

- 3** Select the region number.
The selections for the position displacement compensation method will be displayed.

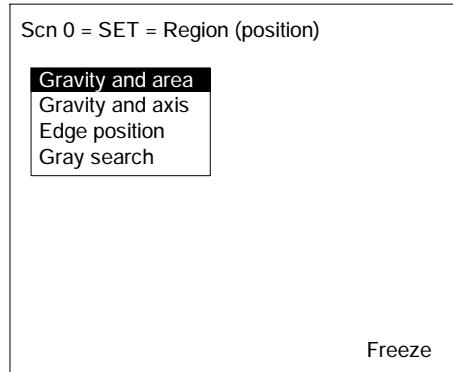

- 4** From this point, the procedures for the various measurement methods are given separately. Refer to the appropriate explanation.

Note Be sure to set the compensation direction after drawing the position displacement compensation region. Position displacement compensation will not be executed just by drawing the region.

Binary Center of Gravity and Area, Binary Center of Gravity and Axis Angle

Images taken by the Camera are made up of 256 gradations. Binary processing is the process whereby these images are divided into black pixels (0) and white pixels (1). The F150 performs measurements on the areas occupied by white pixels.

Binary Center of Gravity and Area

The center of gravity of the areas occupied by the white pixels is calculated and the displacement between this and the reference center of gravity is calculated.

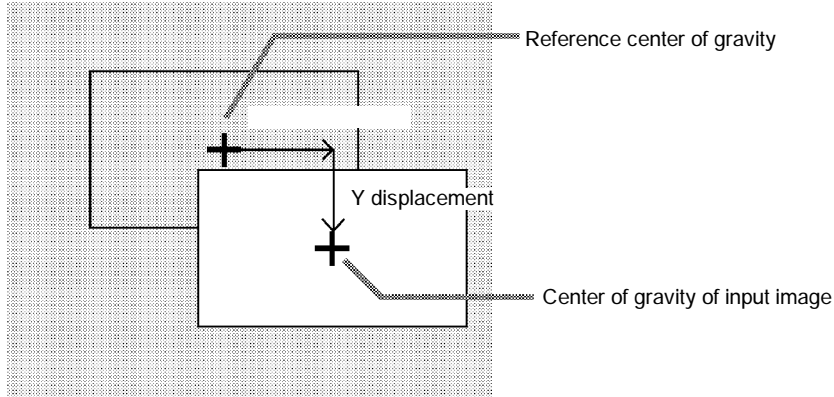

Binary Center of Gravity and Axis Angle

The center of gravity and the axis angle of the area occupied by the white pixels is obtained, and the displacements between these values and those for the model are calculated.

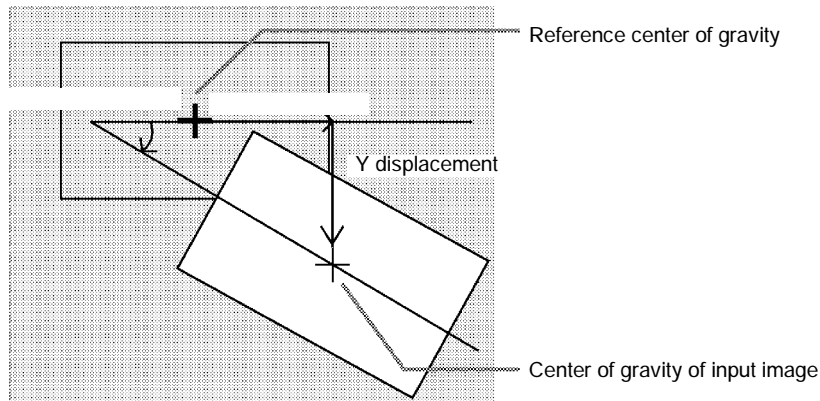

Operational Flow

In **Position compensation/Region**, select **Gravity and area** or **Gravity and axis**.

- 1 Set the binary level.
- 2 Draw the region.
- 3 Set the evaluation criteria.

1 Setting the Binary Level

Set the level for conversion of 256-gradation images into binary images. The F150 performs measurement for the white areas. Therefore, make the settings so that the areas for which the center of gravity or the axis angle are desired are white.

The procedure is the same as for ordinary measurement. → p. 83

Correct

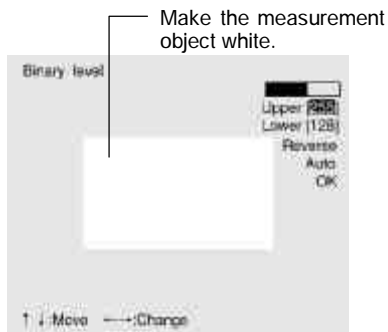

Incorrect

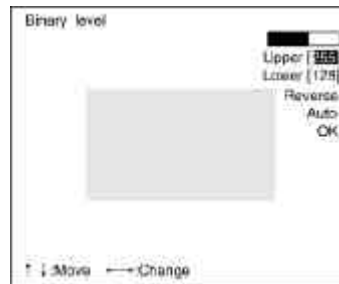

2 Drawing the Region

The center of gravity, or the center of gravity and the axis angle for the white area contained inside the measurement region are obtained. Make a region of a size and position that allows for movement of the range of the measurement object. When drawing of the region has been completed, the center of gravity and the axis angle (when set to find binary center of gravity and axis angle) will be measured. This position will be taken as the reference. Therefore, draw the region after putting the measurement object in a position where the part to be measured lies totally inside the screen.

The procedure is the same as for ordinary measurement. → p. 85

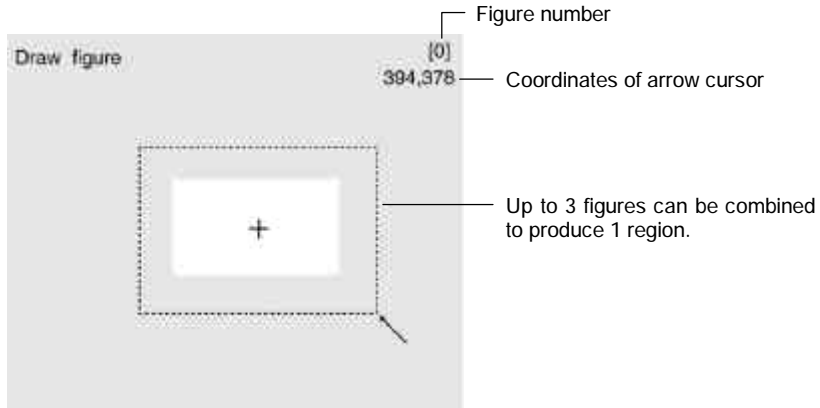

3 Setting the Evaluation Criteria

It is necessary to set evaluation criteria for position displacement compensation in order to evaluate whether the measurement object is contained within the field of view at the time of measurement.

The procedure is the same as for ordinary measurement. → p. 88

Judgement of Position Displacement Compensation and Subsequent Measurement

Judgement	Processing
OK	Measurement is performed after position displacement compensation.
NG	Measurement is performed without position displacement compensation. Output to the OR terminal is NG, irrespective of measurement result.

Examples

- Area

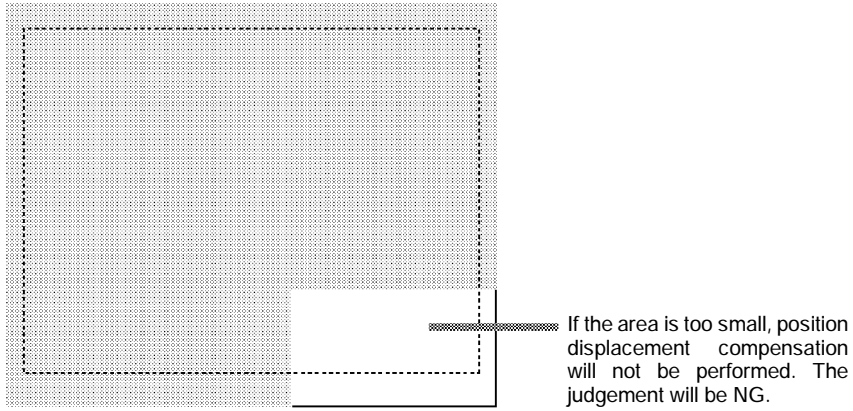

- X Center of Gravity, Y Center of Gravity

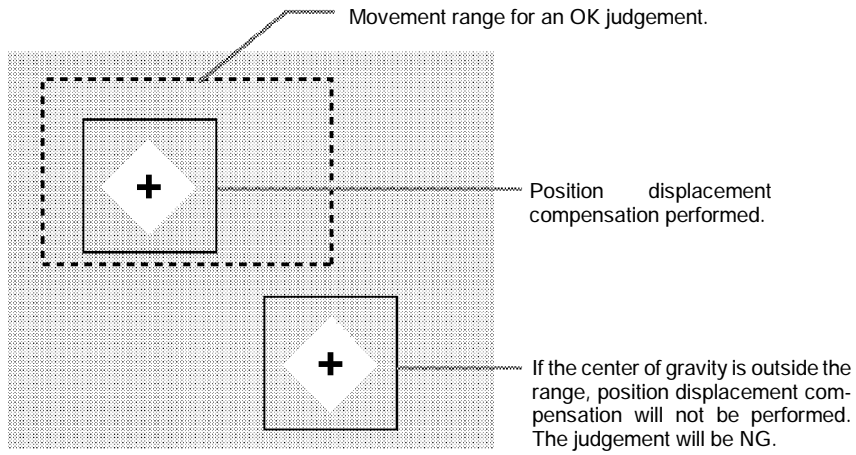

• Axis Angle

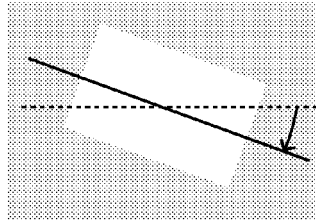

Measurement value for axis angle: 10.000

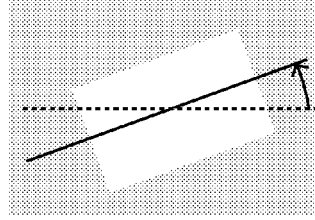

Measurement value for axis angle: -10.000

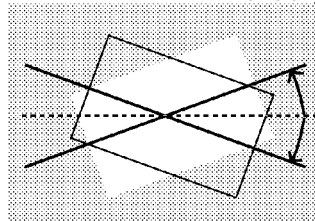

If this range is to be judged OK, set to "-10.000: 10.000."

Gray Edge Position

Edges are identified by changes in the density within the region. The search direction and color change for edge detection can be set for each region.

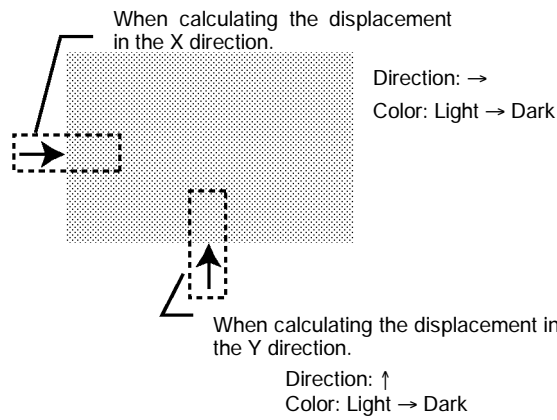

Operational Flow

In **Position compensation/Region**, select **Edge position**.

- 1 Draw the region.
- 2 Set the edge detection conditions and the evaluation criteria.

1 Drawing the Region

Draw the position displacement compensation region so as to include the edge. Draw one box for each region. When drawing of the regions has been completed, the edge positions will be measured. These positions will be taken as the reference positions. Therefore, draw the regions after placing the measurement object in a position where the part to be measured lies totally inside the screen.

The procedure is the same as for ordinary measurement. → p. 91

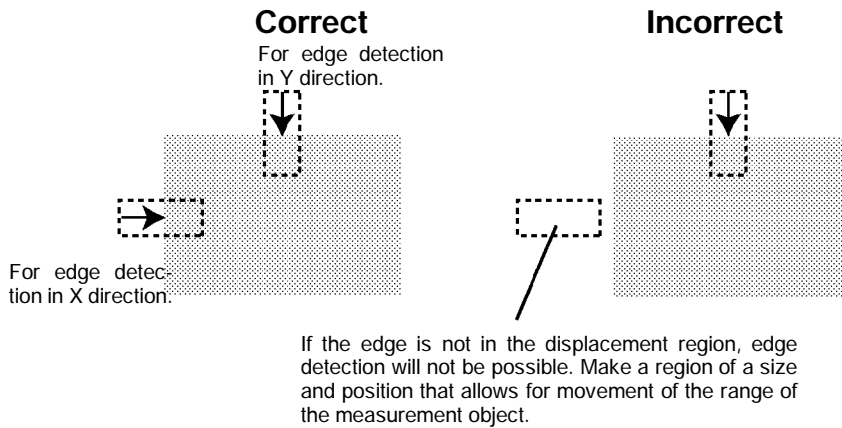

2 Setting Edge Detection Conditions and Evaluation Criteria

Set the conditions and evaluation criteria required to search for an edge.

The procedure is the same as for ordinary measurement. → p. 93

Judgement of Position Displacement and Subsequent Measurement

Judgement	Processing
OK	Measurement is performed after position displacement compensation.
NG	Measurement is performed without position displacement compensation. Output to the OR terminal is NG, irrespective of measurement result.

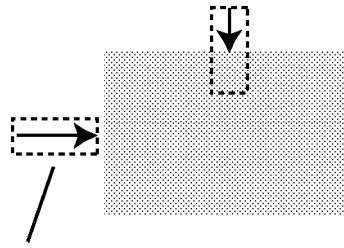

Unless a difference in density that is greater than the set level is detected, position displacement compensation will not be performed. The judgement will be NG.

Gray Search

Register an image pattern (the “model”) in advance. The part of an input image that is most similar to the model is found, and the displacement of its position from that of the reference position is obtained.

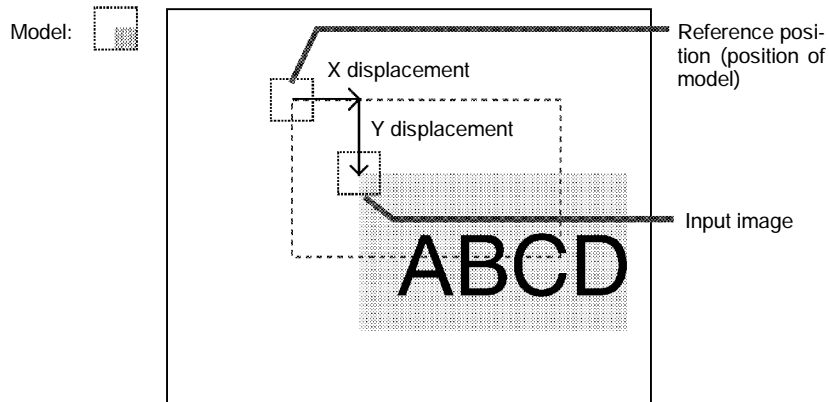

Operational Flow

In *Position compensation/Region*, select **Gray search**.

- 1 Register the model.
- 2 Set the range in which a search is to be made for the model.
- 3 Set the evaluation criteria.
- 4 Change pixel-skipping parameter.
(This step is optional.)

1 Registering the Model

A characteristic part of the measurement image, such as a mark or corner, is registered as a model. The model can be of any size. The registered position will be taken as the reference. Therefore, register the model after putting the measurement object in a position where the part to be registered lies totally inside the screen.

The procedure is the same as for ordinary measurement. → p. 99

Correct

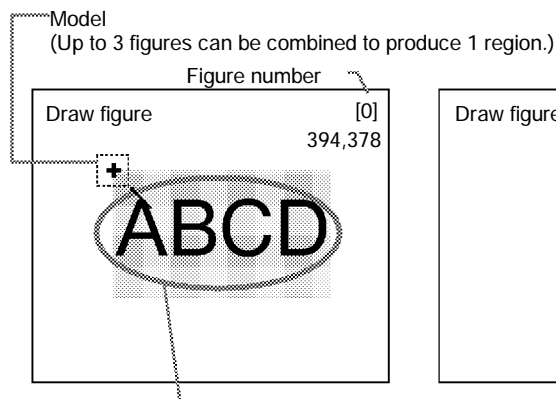

Position the measurement object so that the part to be registered is in the center of the screen.

Incorrect

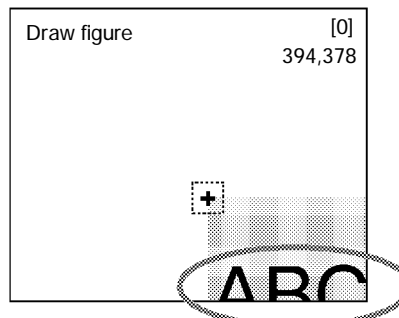

A part to be registered lies outside the screen.

2 Setting the Search Region

Set the region for which the model is to be searched for. It is possible to perform a search for the entire input image but processing time can be reduced and accuracy can be increased by setting limits on the search range.

The procedure is the same as for ordinary measurement. → p. 102

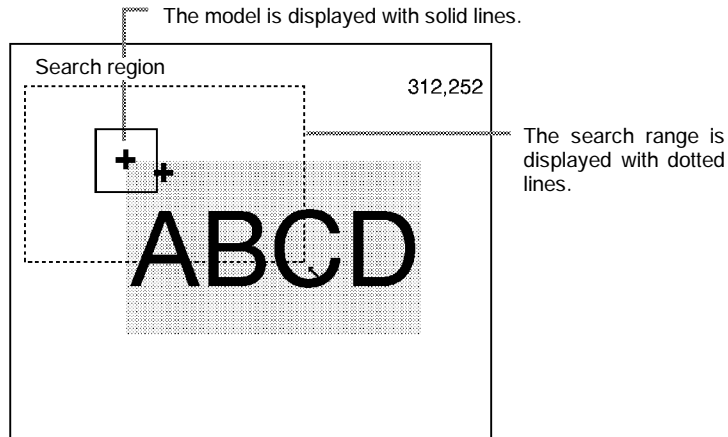

3 Setting the Evaluation Criteria

If the correlation value with the model is low, the wrong place may be found. In order to judge whether the model for position displacement compensation has been correctly identified, it is necessary to set evaluation criteria.

The procedure is the same as for ordinary measurement. → p. 103

Judgement of Position Displacement and Subsequent Measurement

Judgement	Processing
OK	Measurement is performed after position displacement compensation.
NG	Measurement is performed without position displacement compensation. Output to the OR terminal is NG, irrespective of measurement result.

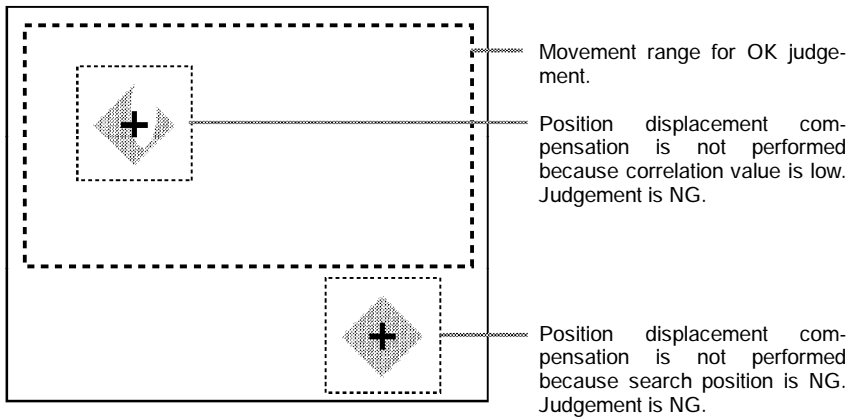

4 Changing Pixel-skipping Parameter (Optional)

The pixel-skipping parameter for searching for the model can be changed. The pixel-skipping parameter is determined according to the speed setting in the evaluation conditions menu. However, from this screen it is also possible to change the pixel-skipping parameter directly.

By making the value larger, the processing time can be reduced. However, the accuracy of the search will be reduced, and depending on the image, the object may not be found. After changing the settings, check whether measurement and search are performed properly.

The procedure is the same as for ordinary measurement. → p. 104

Set how many pixels to skip when searching.

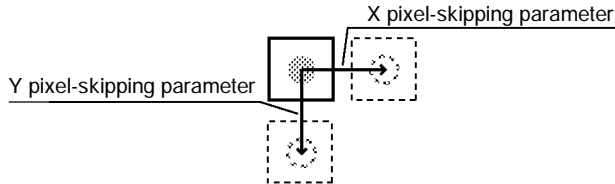

3-3-3 Selecting the Direction for Position Displacement Compensation

Select the direction in which position displacement compensation is performed. Reference values for compensation can be set for the X direction, Y direction, or θ direction regardless of whether compensation is performed or not.

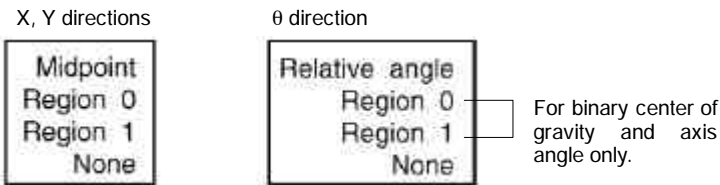

Midpoint, Relative Angle of 2 Regions

Position displacement compensation is performed using the coordinates of the center of gravity (midpoint) and the angle (relative angle) of the line joining 2 regions. The relative angle is expressed in the range 0 to 360° with the X axis taking a value of 0° and the direction from the X axis to the Y axis as positive.

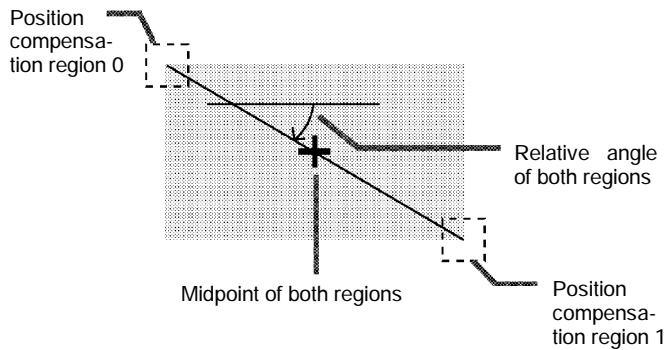

Examples:

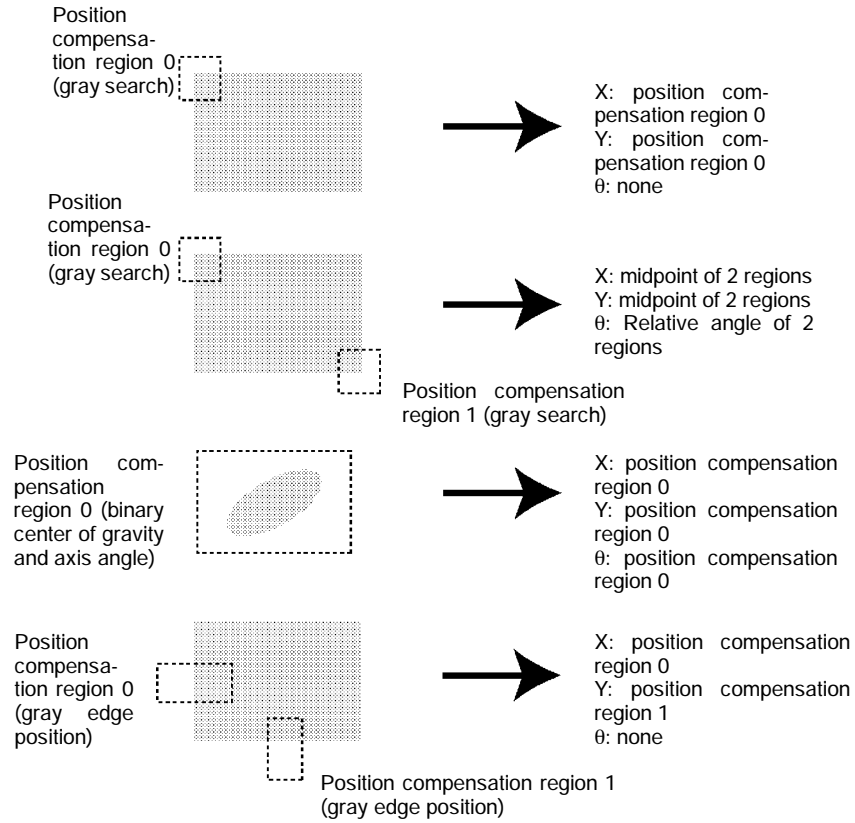

Procedure

- 1 Go to *Position compensation/Direction*.

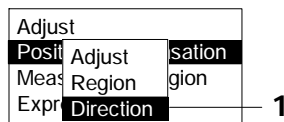

2 Select reference values for X, Y, and θ .

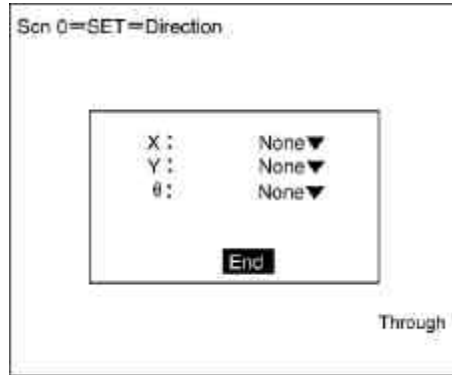

3 Select **End** to enter the settings.

3-3-4 Changing Settings or Clearing

The set data can be changed or cleared.

Procedure

1 Move the cursor to the number of the region to be changed or cleared and press the **ENT** Key.
The selection **Change settings/Clear** will be displayed.

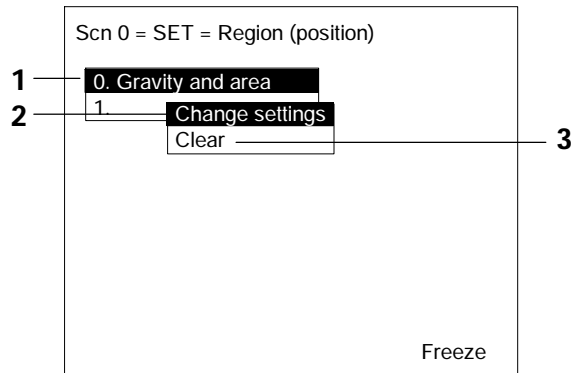

2 To change settings select **Change settings**.
The items that can be changed will be displayed.

Drawing Measurement Regions and Setting Evaluation Criteria Section 3-4

- 3** To clear all the settings, select **Clear**.
A confirmation message will be displayed. Select **Execute** to clear the settings and exit this screen.

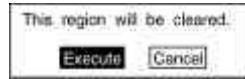

3-4 Drawing Measurement Regions and Setting Evaluation Criteria

If two Cameras are used, **Region 0** will be displayed for Camera 0 and **Region 1** will be displayed for Camera 1. → p. 36

3-4-1 Selecting Region Number

The F150 has 16 measurement regions and 12 measurement methods. The measurement method can be set separately for each region.

Two-camera Operation If two Cameras are used, there are 8 regions (0 to 7) for **Measurement region 0** and 8 regions (8 to 15) for **Measurement region 1**.

Example: Using Two Measurement Regions

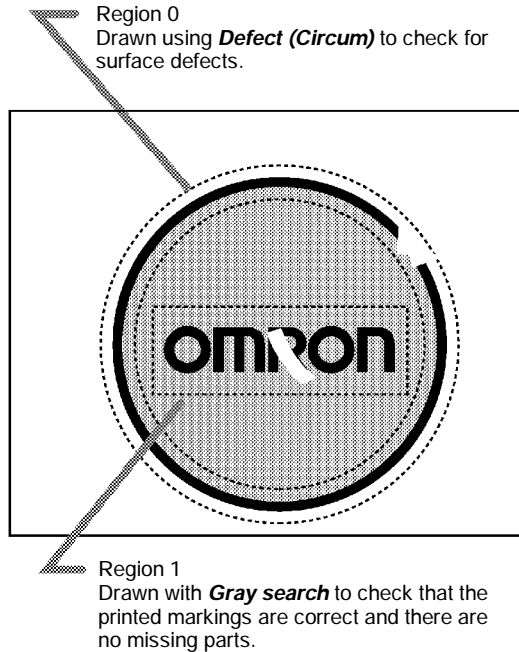

Drawing Measurement Regions and Setting Evaluation Criteria Section 3-4

Procedure

1 Select **Measurement region**.

The screen for selecting the region number will be displayed.

Press the **SHIFT + ESC** Keys to reverse (dark ↔ clear) the background.

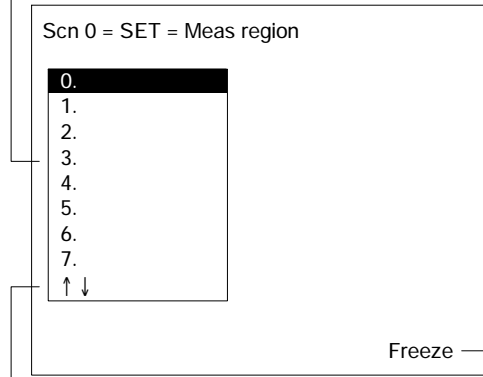

Scn 0 = SET = Meas region

0.
1.
2.
3.
4.
5.
6.
7.
↑ ↓

Freeze

Press the **SHIFT** Key together with the **Up/Down** Keys to switch display images. → p. 164

Press the **Down** Key to display region numbers 8 to 15.

Two-camera Operation

If two Cameras are used, since there are only 8 regions for each Camera, the up/down arrows will not be displayed.

2 Select the desired region number.

The selections for the measurement method will be displayed.

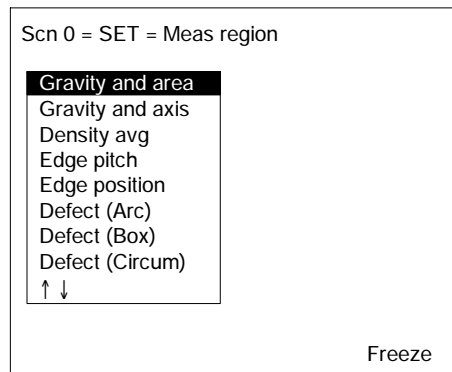

Scn 0 = SET = Meas region

Gravity and area
Gravity and axis
Density avg
Edge pitch
Edge position
Defect (Arc)
Defect (Box)
Defect (Circum)
↑ ↓

Freeze

Drawing Measurement Regions and Setting Evaluation Criteria Section 3-4

3 From this point, the procedures for the various measurement methods are given separately. Refer to the appropriate explanation.

3-4-2 Binary Center of Gravity and Area and Axis Angle

Images taken by the Camera are made up of 256 gradations. To obtain the binary center of gravity and the area, or the binary center of gravity and the axis angle, these images are converted into binary images. This conversion involves dividing the image into black pixels (0) and white pixels (1). The F150 performs measurements on the areas occupied by white pixels.

Binary Center of Gravity and Area

The area and the center of gravity of the area occupied by the white pixels is obtained.

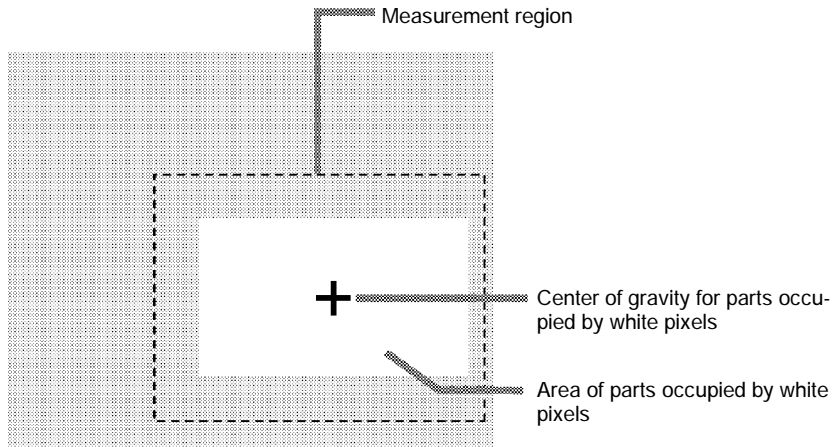

Drawing Measurement Regions and Setting Evaluation Criteria Section 3-4

Binary Center of Gravity and Axis Angle

The area, center of gravity, and axis angle of the area occupied by the white pixels are obtained. The processing time will be longer than the processing time to obtain the binary center of gravity and area by the time taken to obtain the axis angle.

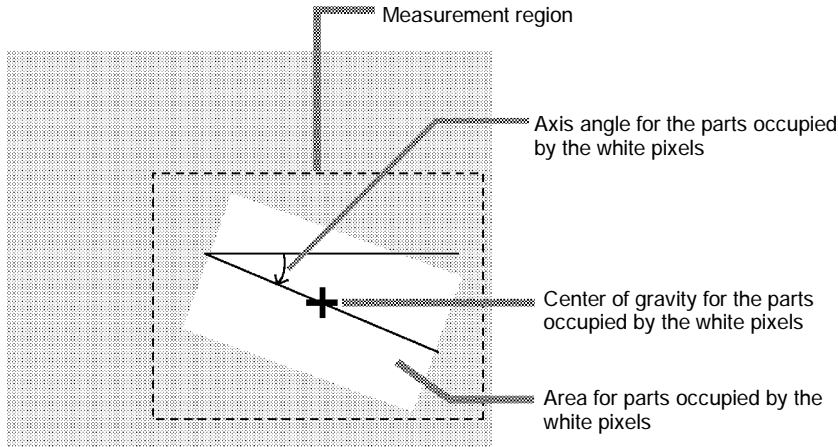

Operational Flow

- 1 Set the binary level.
- 2 Draw the measurement region
- 3 Set the evaluation criteria.

1 Setting the Binary Level

Set the level for conversion of 256-gradation images into binary images. The F150 performs measurements on the white areas. Therefore, set the binary level so that the measurement object is represented by white pixels.

Procedure

- 1 Go to **Measurement region**/*<Region number>*/**Gravity & area** (or **Gravity & axis**).
- 2 Select **Binary**.
The screen for setting the binary level will be displayed.

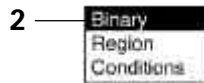

- 3 Move the cursor to the upper limit and change the value as desired using the **Left** and **Right** Keys.

Drawing Measurement Regions and Setting Evaluation Criteria Section 3-4

Press the **Right** Key to increase the smallest digit by 1 (use with **SHIFT** Key to increase by 10). Press the **Left** Key to decrease the smallest digit by 1 (use with **SHIFT** Key to decrease by 10).

- 4 Change the lower limit in the same way.
- 5 Select **OK** to enter the settings and exit this screen.

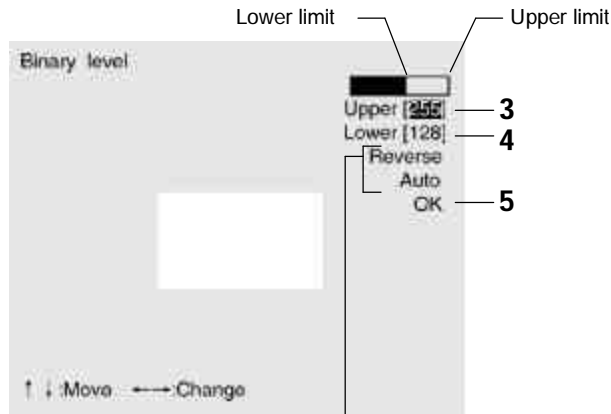

Select **Reverse** to reverse dark and clear in the display.
If **Auto** is selected, the F150 will automatically determine a binary level.

Note It is also possible to set the binary level so that measurement is performed only for an intermediate density range. However, it is not possible to reverse this range and perform measurement for densities excluding this range.

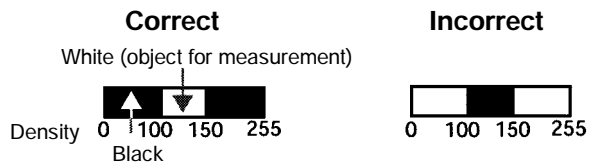

Drawing Measurement Regions and Setting Evaluation Criteria Section 3-4

2 Drawing the Measurement Region

Regions can be created by combining up to 3 different figures.

Procedure

1 Select **Region**.

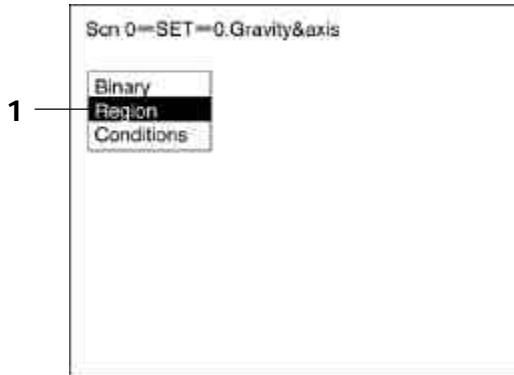

2 Select **New**.

3 Select the shape of the desired figure.

Refer to the following page for details on drawing regions: → **p. 28**

4 Select the desired drawing mode (**OR/NOT**).

The screen for drawing the region will be displayed.

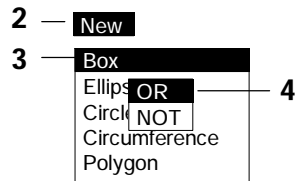

Drawing Measurement Regions and Setting Evaluation Criteria Section 3-4

5 Draw the region with the shape selected.

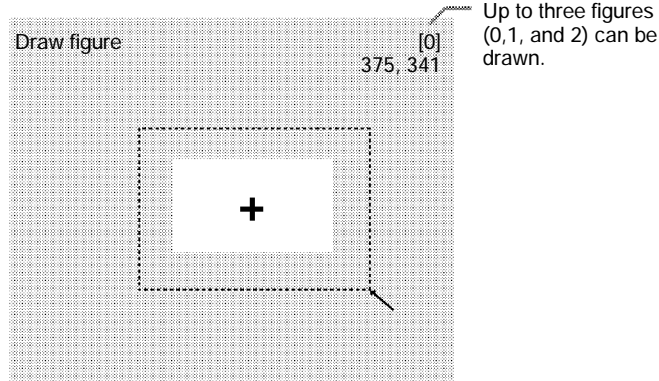

6 If additional figures are to be drawn, select **Add**. Repeat steps 3 to 5 as necessary to create the desired shape. Once 3 figures have been drawn, **Add** will no longer be displayed.

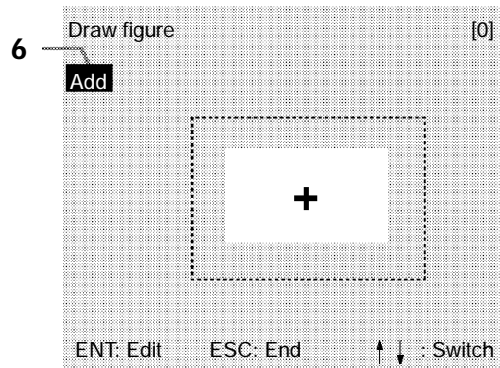

7 After drawing is completed, press the **ESC** Key while the screen for step 6 is displayed. The measurement region will be registered and the screen in step 1 will be returned. The cursor arrow will be displayed at the position of the center of gravity. If more than one figure has been drawn, the rectangle that circumscribes the figures will be displayed, and the cursor arrow will be displayed at the position of the center of gravity of this rectangle.

Drawing Measurement Regions and Setting Evaluation Criteria Section 3-4

Circumscribing Rectangle

The "circumscribing rectangle" is the smallest rectangle that contains all of the figures.

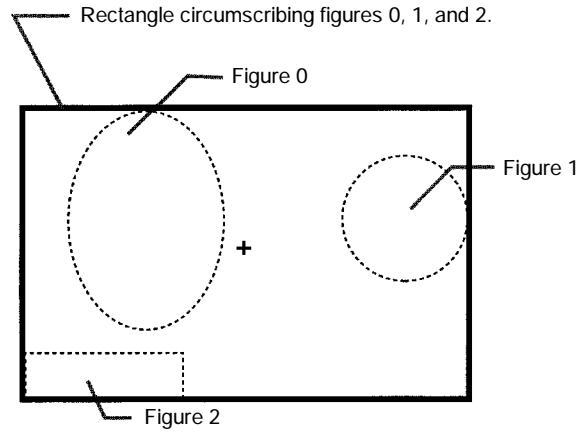

Correcting or Clearing Figures

- 1 In the screen for step 6 above, select the figure to be changed or cleared using the **Up** and **Down** Keys and press the **ENT** Key.

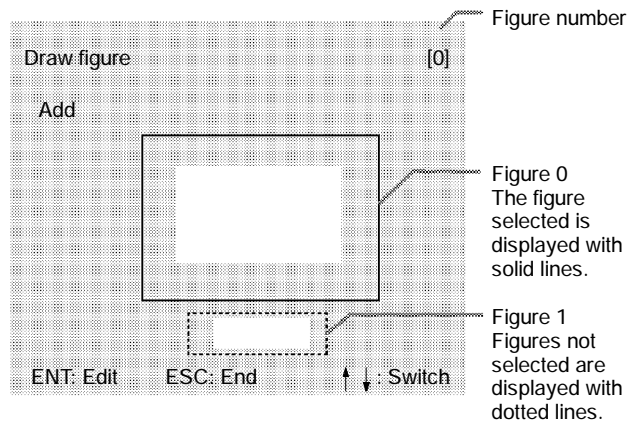

Drawing Measurement Regions and Setting Evaluation Criteria Section 3-4

2 The selections **Correct** and **Clear** will be displayed. Select the desired operation.

- Correct** — If **Correct** is selected, the screen for selecting the region number will be displayed. Correct the size and position of the figure as desired.
- Clear** — If **Clear** is selected, the selected figure will be cleared.

3 Setting the Evaluation Criteria

Make settings for the area, center of gravity, and axis angle.

Binary Center of Gravity and Area

Scn 0 = SET = 0. Gravity and area

Binary	
R	Area : 2035
C	[2000.000: 2300.000
	Gravity X : 180
	[0.000: 511.000]
	Gravity Y : 250
	[0.000: 483.000]
End	

Area range for an OK judgement.
(0 to 9,999,999.999)

Range of movement of the measurement object in the X direction for an OK judgement.
(-9,999.999 to 9,999.999)

Range of movement of the measurement object in the Y direction for an OK judgement.
(-9,999.999 to 9,999.999)

- Measurement result for the displayed image (after calibration). Use this value as a reference for setting upper and lower limits.

The center of gravity must be between the lower and upper limits for an OK judgement.

The area should be between the lower and upper limits for an OK judgement.

Drawing Measurement Regions and Setting Evaluation Criteria Section 3-4

Binary Center of Gravity and Axis Angle

Scn 0 = SET = 0. Gravity and axis

Binary	
R	Area : 2035
C	[2000: 2300
	Gravity X : 180
	[0.000: 511.000]
	Gravity Y: 250
	[0.000: 483.000]
	Axis : 75
	[60.000: 90.000]
	End

Area range for OK judgement.
(0 to 9,999,999.999)

Range of movement of the measurement object in the X direction for an OK judgement.
(-9,999.999 to 9,999.999)

Range of movement of the measurement object in the Y direction for an OK judgement.
(-9,999.999 to 9,999.999)

Rotation range of the measurement object for an OK judgement. (Range: -180.000 to 180.000. However, only values in the range -90.000 to 90.000 will be output.)

○ Measurement result for the displayed image (after calibration). Use this value as a reference for setting upper and lower limits.

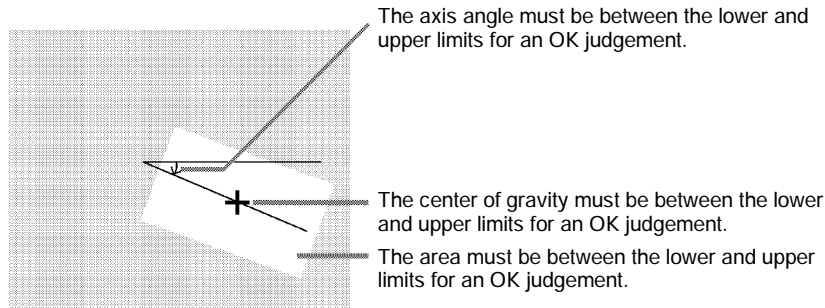

Drawing Measurement Regions and Setting Evaluation Criteria Section 3-4

- Axis Angle

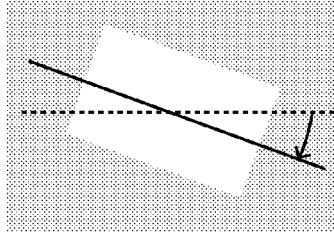

Measurement value for axis angle: 10.000

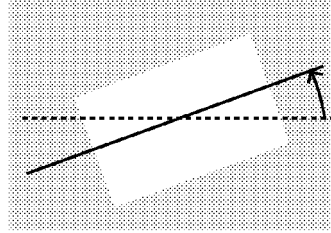

Measurement value for axis angle: -10.000

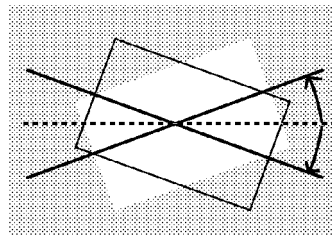

If this range is to be judged OK, set to "-10.000: 10.000."

Procedure

- 1 Select **Conditions**.

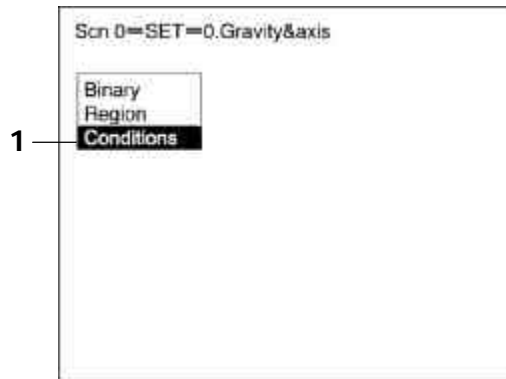

- 2 Set the items.
Refer to the following page for details on inputting values:
→ p. 26
- 3 Select **End** to enter the settings.

Drawing Measurement Regions and Setting Evaluation Criteria Section 3-4

3-4-3 Gray Edge Position

Edges are identified by changes in the density within the measurement region. The search direction and color change for edge detection can be set for each region.

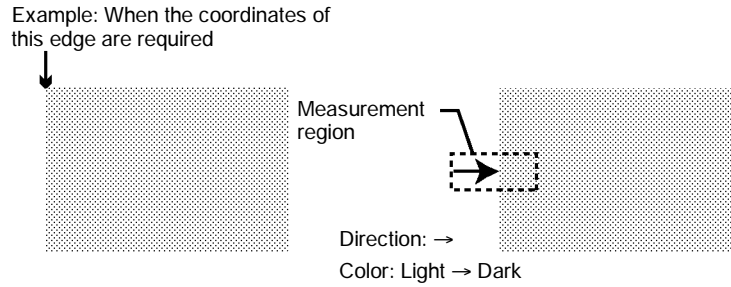

Operational Flow

- 1 Draw the measurement region.
- 2 Set the edge detection conditions and the evaluation criteria.

1 Drawing the Measurement Region

Draw the measurement region so as to include the edge.

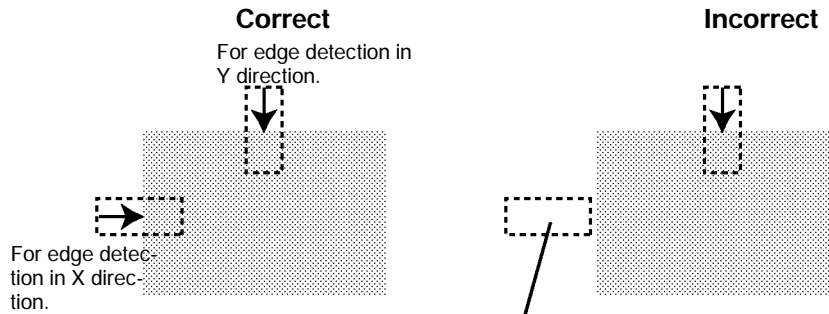

If the edge is not in the measurement region, edge detection will not be possible. Make a region of a size and position that allows for movement of the range of the measurement object.

Procedure

- 1 Go to **Measurement region**/*<Region Number>*/**Gray edge position**.
- 2 Select **Region**.



Drawing Measurement Regions and Setting Evaluation Criteria Section 3-4

- 3** Draw a box-shaped measurement region.
When the coordinates of the lower right corner are specified, the region will be registered and the screen for step 2 will be returned.

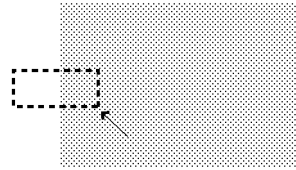

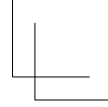
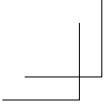

Drawing Measurement Regions and Setting Evaluation Criteria Section 3-4

2 Setting Edge Detection Conditions and Evaluation Criteria

Set the conditions necessary for finding an edge, and the evaluation criteria.

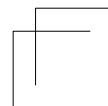
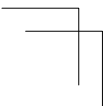

Drawing Measurement Regions and Setting Evaluation Criteria Section 3-4

Scn 0 = SET = 1. Edge position

Region			
C Direction	: → B	Edge detection direction (↑, ↓, →, ←)	
Color	: Light → Dark B	Edge color change (Light → Dark, Dark → Light)	
Edge level	: [50%]		
Noise level	: [20]		
Position	:		
	[0.000 : 511.000]	Edge position range for an OK judgement (-9,999.999 to 9,999.999)	
End			

Measurement result for the displayed image (after calibration).

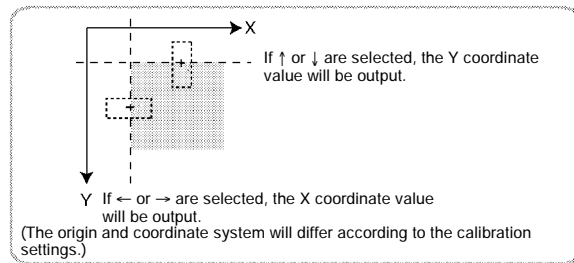

Set the level of density for checking the existence of edges. (0 to 255)
The maximum and minimum densities for the measurement region are obtained, and if this difference is less than the noise level, then there are deemed to be no edges.
The default setting of 20 will be appropriate in most cases. If edges are erroneously detected for this noise level, however, set the noise level to a higher value.
Max. density - Min. density Noise level → No edges detected → NG result
Max. density - Min. density Noise level → Edges detected → Existence of measurement object confirmed

Example: For noise level setting of 30

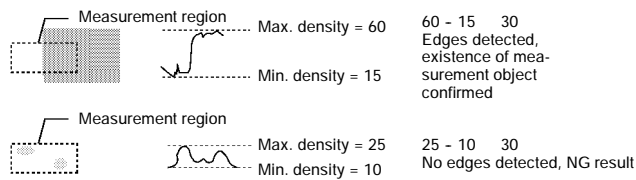

Set the level of density change for identification as an edge. (0 to 100)
The default setting of 50% will be appropriate in most cases.

Edges are detected in the following way:

1. The density distribution for the entire measurement range is obtained.
2. The range from the smallest density value to the largest is calibrated to a range of 0% to 100%.
3. Places where the change in density is above the set density level are detected as edges.

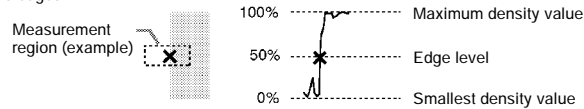

Drawing Measurement Regions and Setting Evaluation Criteria Section 3-4

Procedure

- 1 Select **Conditions**.



- 2 Set the items.

Refer to the following page for details on inputting values: → p. 26

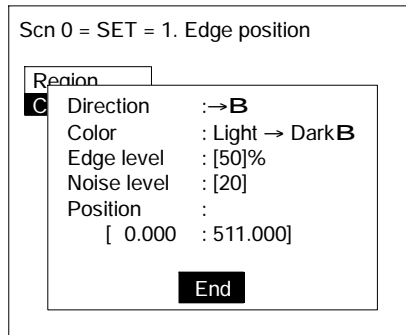

- 3 Select **End** to enter the settings.

3-4-4 Edge Pitch

Use the following procedure to find edges through density variations and obtain the number of objects, width, and pitch.

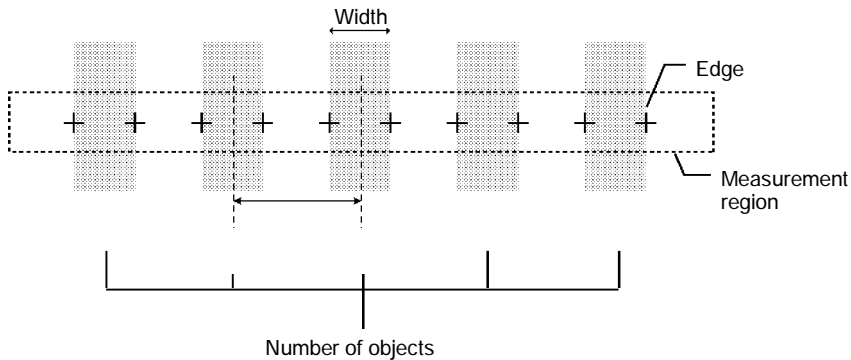

Operational Flow

- 1 Draw the measurement region.
- 2 Set the edge detection conditions and the evaluation criteria.

Drawing Measurement Regions and Setting Evaluation Criteria Section 3-4

1 Drawing the Measurement Region

Draw the measurement region so as to include all of the measurement objects.

(Example 1)

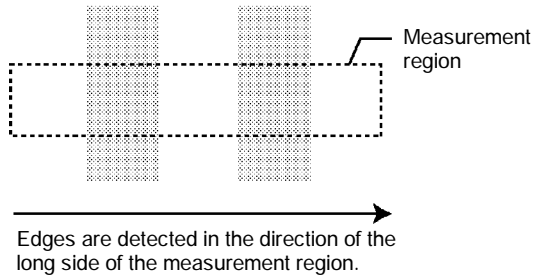

(Example 2)

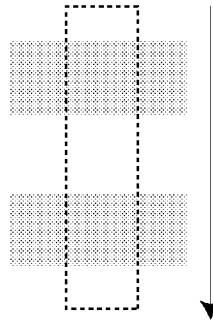

Procedure

- 1** Go to *Measurement region*/*<Region number>*/*Edge pitch*.
- 2** Select *Region*.



- 3** Draw a box-shaped measurement region.
When the coordinates of the lower right corner are specified, the region is registered and the screen for step 2 will be returned.

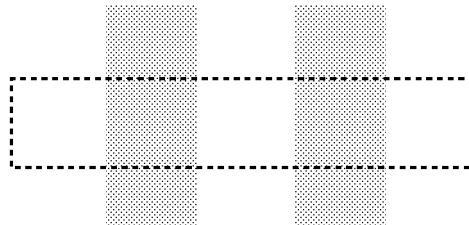

Drawing Measurement Regions and Setting Evaluation Criteria Section 3-4

2 Setting Edge Detection Conditions and Evaluation Criteria

Set the conditions necessary for finding an edge, and the evaluation criteria.

Scn 0 = SET = 2. Edge pitch

Re	Target color	:	White	B	
C	Edge level	:	[10]	%	
	Min. level	:	[5]		
	Number of edges	:	(20)		
			[20: 20]		
	Average pitch	:	(9.332)		
			[9.000: 10.000]		
	Average width	:	(3.234)		
			[2.000: 4.000]		
End					

Color of objects to be counted (White/Black)

Minimum level: For prevention of incorrect detection due to noise (0 to 255). (If the density variation is less than this value, it will be considered to be noise.)

Range of number of objects for an OK judgement (0 to 255)

Average pitch range for an OK judgement (0 to 9,999.999)

Press the **Down** Key to display the setting menu for the average width range (0 to 9,999.999)

○ Measurement result for the displayed image
The values for average pitch and average width are values after calibration.

Threshold value for finding an edge (0 to 100).
If the measured number of objects is less than the actual number of objects, set the edge level (or the minimum level) to a smaller value. If the measured number of objects is greater than the actual number of objects, set the edge level (or the minimum level) to a larger value.

- Edges are detected in the following way:
1. The density differentials for the entire measurement range are obtained.
 2. The maximums and minimums that satisfy the edge level setting are detected as edges.

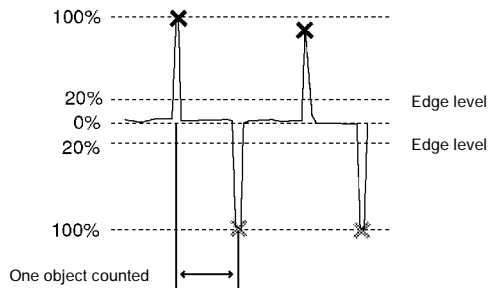
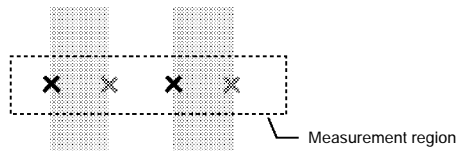

Drawing Measurement Regions and Setting Evaluation Criteria Section 3-4

Procedure

- 1** Select **Conditions**.
- 2** Set the items.
Refer to the following page for details on inputting values: → p. 26



- 3** Select **End** to enter the settings.

3-4-5 Gray Search and Precise Search

Register an image pattern (the “model”) in advance. The part of an input image that is most similar to the model is found, and the degree of similarity is expressed with a correlation value. Perform processing directly on the density image taken by the Camera.

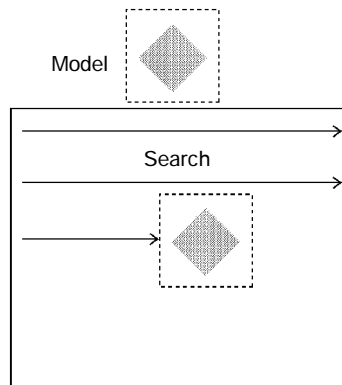

Gray Search

With a gray search, the position is obtained in pixel units.

Precise Search

With a precise search, the position is obtained in sub-pixel (smaller than a pixel) units. The processing time is longer than that for gray search.

Operational Flow

- 1** Register the model
- 2** Set the range in which a search is to be made for the model.
- 3** Set the evaluation criteria.
- 4** Change pixel-skipping parameter.
(This step is optional.)

Drawing Measurement Regions and Setting Evaluation Criteria Section 3-4

1 Registering the Model

The area of the image to be inspected is registered as a model.
The model can be of any size.

Procedure

1 Go to **Measurement region**/*<Region number>*/**Gray search** (or **Precise search**).

2 Select **Model registration**.



3 Select **New**.

4 Select the shape of the figure to be drawn.

Refer to the following page for details on drawing regions: → **p. 28**

5 Select the drawing mode (**OR/NOT**).

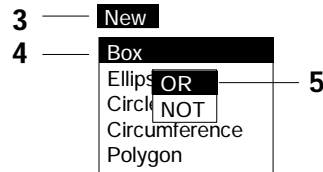

6 Draw the figure in the range desired as the model.

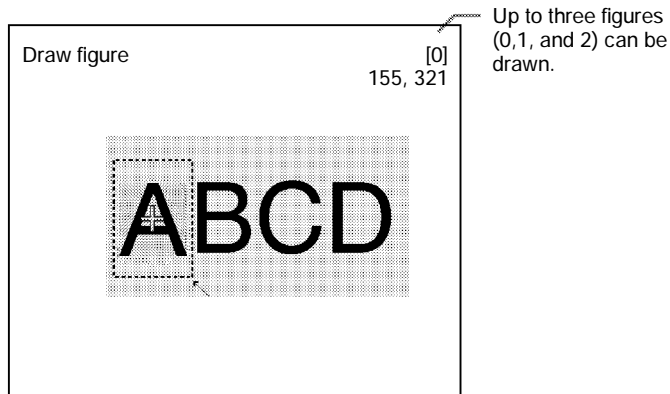

7 If additional figures are to be drawn, select **Add**.

Repeat steps 4 to 6 as necessary to create the desired

Drawing Measurement Regions and Setting Evaluation Criteria Section 3-4

shape.
Once 3 figures have been drawn, **Add** will no longer be displayed.

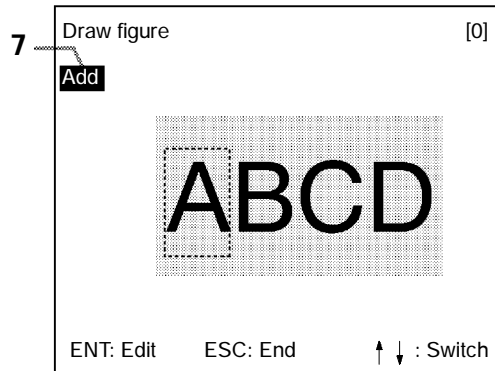

- 8 If the drawing for the region is finished, press the **ESC** Key while in the screen for step 7. The arrow cursor will be displayed.
- 9 Move the arrow cursor to the point whose coordinates are to be output as the search position, and press the **ENT** Key. The region is set and the screen for step 2 is returned.

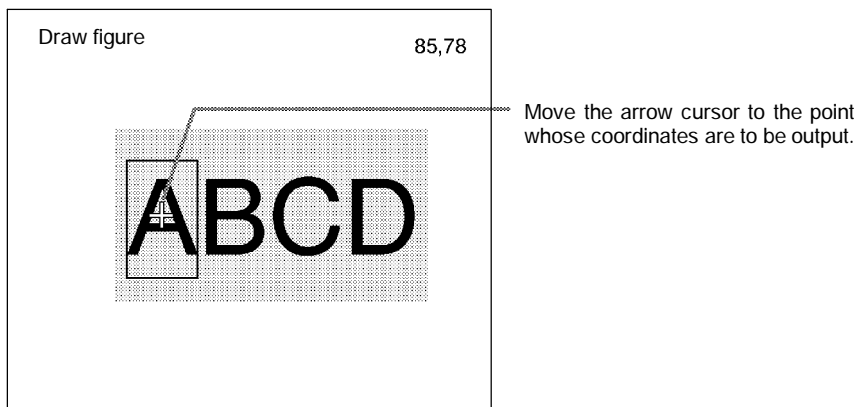

Drawing Measurement Regions and Setting Evaluation Criteria Section 3-4

Correcting or Clearing Figures

- 1 In the screen for step 7 above, select the figure to be changed or cleared using the **Up** and **Down** Keys and press the **ENT** Key.

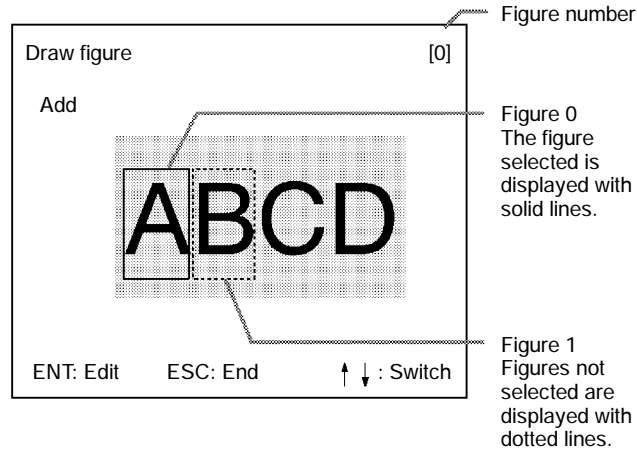

- 2 The selections **Correct** and **Clear** will be displayed. Select the desired operation.

Correct	If Correct is selected, the screen for selecting the region number will be displayed. Correct the size and position of the figure as desired.
Clear	

2 Setting the Search Region

Set the region for which the model is to be searched for. It is possible to perform a search for the entire input image but processing time can be reduced and accuracy can be increased by setting limits on the search range.

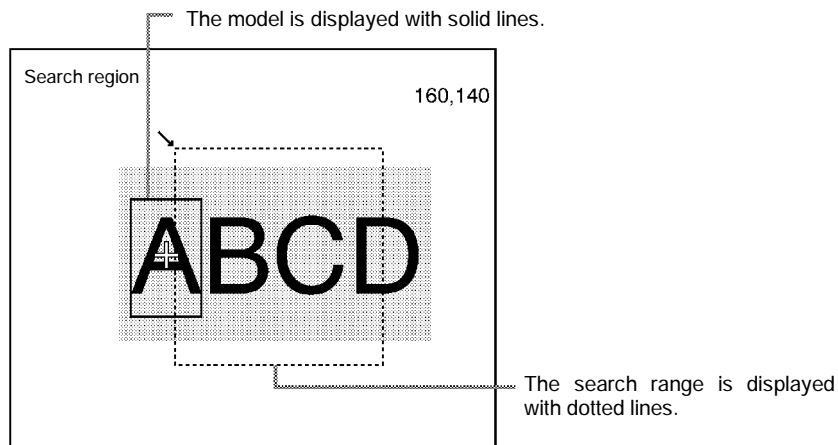

Procedure

- 1 Select **Search region**.

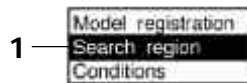

- 2 Draw a box-shaped search region.
When the coordinates of the lower right corner are speci-

Drawing Measurement Regions and Setting Evaluation Criteria Section 3-4

fied, the region will be registered, and the screen for step 1 will be returned.

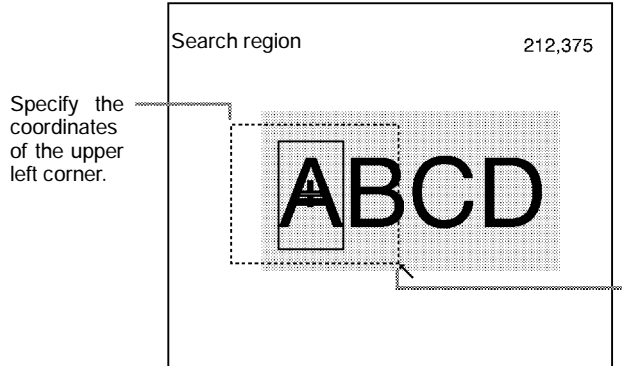

3 Setting the Evaluation Criteria

Evaluation criteria are set for the correlation with the model and the coordinates where the model is found.

Scn 0 = SET = 4. Gray search

Model registration		
Correlation	: 79 [80: 100]	Correlation value range for an OK judgement (0 to 100)
Position X	: 180 [0.000 : 511.000]	Range of movement of the measurement object in the X direction for an OK judgement. (-9,999.999 to 9,999.999)
Position Y	: 250 [0.000 : 511.000]	Range of movement of the measurement object in the Y direction for an OK judgement. (-9,999.999 to 9,999.999)
Speed	: 3B	
End		

Search speed

LOW	Slow
1	↑
2	
3	
HIGH	Fast

○ Measurement result for the displayed image (after calibration). Use this value as a reference for setting upper and lower limits.

Drawing Measurement Regions and Setting Evaluation Criteria Section 3-4

Correlation:

When the correlation criteria is 70 to 100:

	Image 0	Image 1	Image 2	Image 3
Correlation:	96	65	62	78
Judgement:	OK	NG	NG	OK

X, Y Positions:

Range of movement in X direction for an OK judgement.

Range of movement in Y direction for an OK judgement.

NG OK

Procedure

- 1 Select **Conditions**.



- 2 Set the items.

Refer to the following page for details on inputting values: → p. 26

- 3 Select **End** to enter the settings.

4 Changing Pixel-skipping Parameter (Optional)

The pixel-skipping parameter for searching for the model can be changed. The pixel-skipping parameter is determined according to the speed setting in the evaluation criteria menu. However, from this screen it is also possible to change the pixel-skipping parameter directly. (Note that if the pixel-skipping parameter is changed, the speed will be changed automatically.)

By making the value larger, the processing time can be reduced. However, the accuracy of the search will be reduced, and depending on the image, the object may not be found. After changing the settings, check whether measurement and search are performed properly.

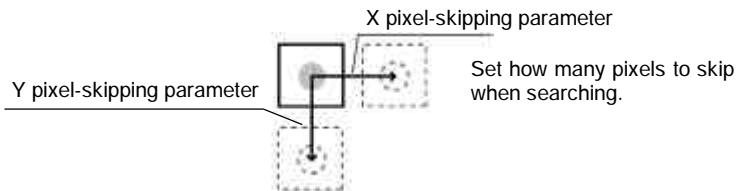

Drawing Measurement Regions and Setting Evaluation Criteria Section 3-4

Procedure

- 1 Press the **SHIFT + ESC** Keys with the screen in this state. The screen for setting the pixel-skipping parameter will be displayed.

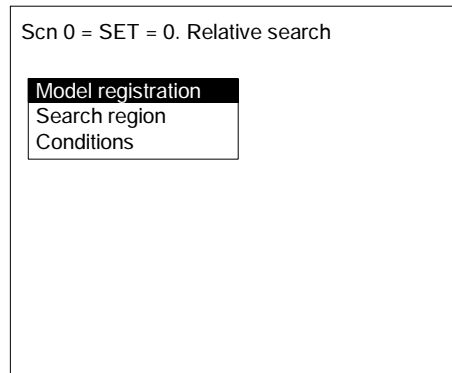

- 2 Change the pixel-skipping parameters for X and Y as desired.

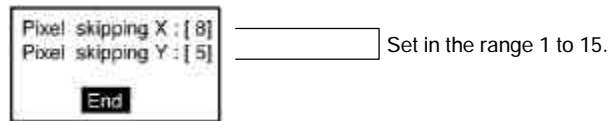

- 3 Select **End**. The estimated search time for a search based on the set pixel-skipping parameters will be displayed.

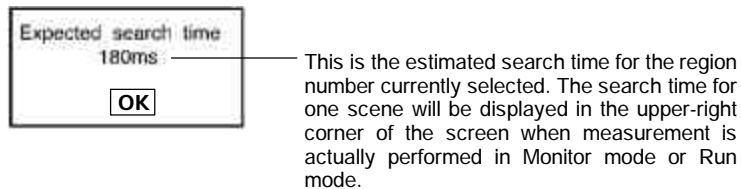

- 4 Select **OK** to enter the settings and to exit this screen.

3-4-6 Surface Defect

Surface defects in the measurement region are checked for through variations in density.

Operational Flow

- 1 Draw the measurement region.

Drawing Measurement Regions and Setting Evaluation Criteria Section 3-4

2 Set the surface defect detection conditions and the evaluation criteria.

1 Drawing the Measurement Region

Choose the shape of the measurement region from arc, box, circumference, or line.

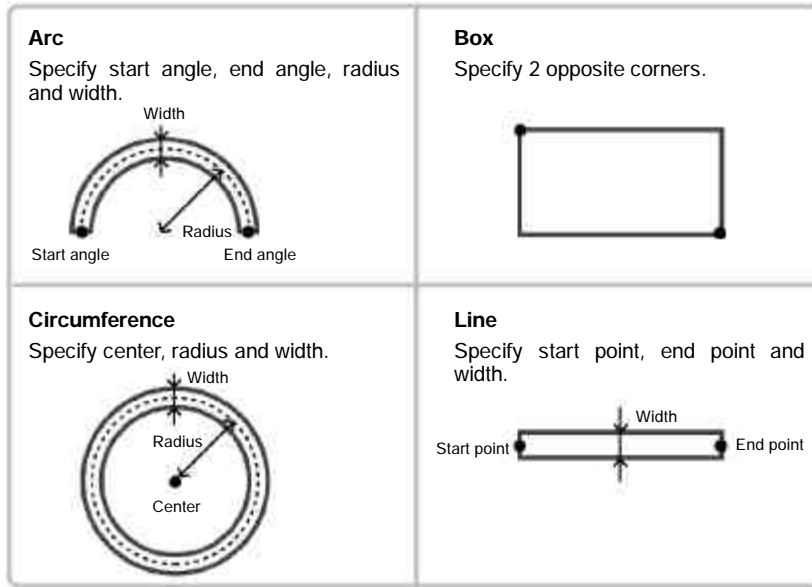

- Note**
1. Do not include areas with marks and designs in the measurement region. It will not be possible to distinguish them from surface defects, and measurement will not be performed properly.
 2. The following kinds of arcs cannot be drawn.
 - Arcs whose center lies outside of the screen.
 - Arcs with a radius of more than 483 pixels.

Procedure

1 Go to **Measurement region**/**<Region number>**/**Defect ()**.

2 Select **Region**.



3 Draw the measurement region.

The measurement region will be registered and the screen for step number 2 will be returned.

Drawing Measurement Regions and Setting Evaluation Criteria Section 3-4

2 Setting Surface Defect Detection Conditions and Evaluation Criteria

When the measurement region has been drawn, small boxes will be created inside the measurement region. These boxes are called "elements." The density for each element is calculated, and this density is compared with the density of the elements around it. The degree of density dispersion is used to detect surface defects. The detection conditions "Element size" and "Compare pitch" (the number of elements between a given element and the element it is compared with) can be set.

Defect Calculation Method

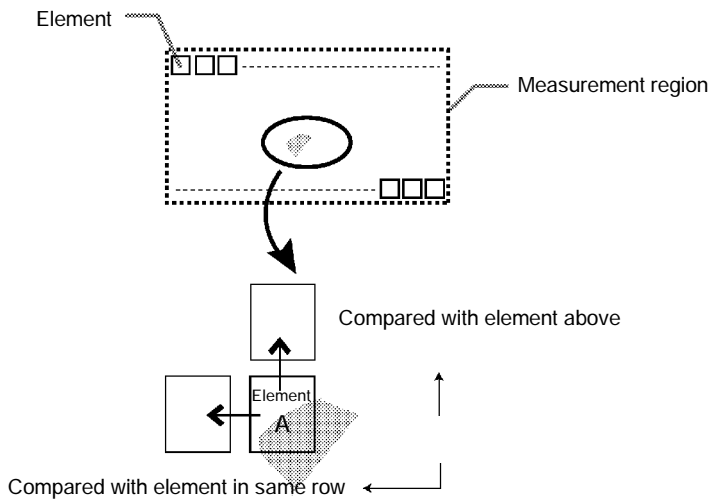

The defect is calculated for all of the elements. If the largest defect is larger than the evaluation criteria, the measurement region is judged to contain a defect. When deciding the evaluation criteria, perform measurements of several samples and base the evaluation criteria on the defects for those samples.

Element Size and Compare Pitch

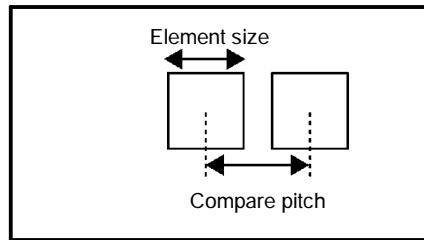

Drawing Measurement Regions and Setting Evaluation Criteria Section 3-4

Condition Setting Screen

Scn 0 = SET = 0. Defect (Line)

Region		
C Element size	: [10]	4 to 80 (default setting: 10)
Compare pitch	: [1]	1 to 6 (default setting: 1)
Defect	:80 [30]	Defect evaluation criteria. If the defect exceeds this value the judgement will be NG. (0 to 255)
Density Max.	:80 [255]	If the largest and smallest density values in the inspected region lie within the lower and upper limits, the judgement will be OK. (0 to 255)
Density Min.	:50 [0]	

End

Measurement results for the displayed image.
Use these values as a reference for setting upper and lower limits.

Procedure

- 1 Select **Conditions**.



- 2 Set the items.
Refer to the following page for details on inputting values: → p. 26
- 3 Select **End** to enter the settings.

3-4-7 Density Averaging

The density (0 to 255) is obtained for each pixel and measurements are made based on the average density.

Drawing Measurement Regions and Setting Evaluation Criteria Section 3-4

Example: Existence of Measurement Object

The existence of a measurement object is determined using differences in the average density.

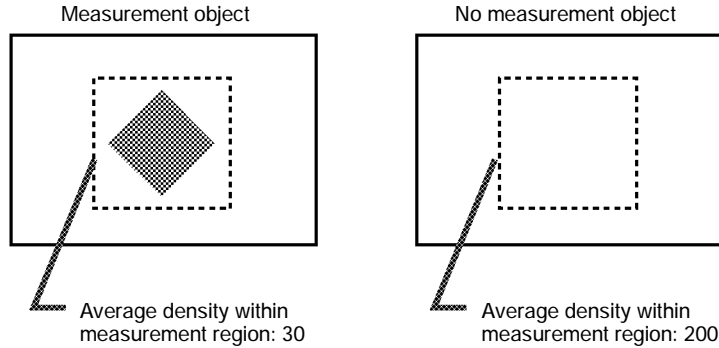

Operational Flow

- 1 Draw the Measurement Region.
- 2 Set the evaluation criteria.

1 Drawing the Measurement Region

Regions can be created by combining up to 3 different figures.

Procedure

- 1 Go to **Measurement region**/**<Region number>**/**Density averaging**.
- 2 Select **Region**.



- 3 Select **New**.
- 4 Select the shape of the desired figure.
Refer to the following page for details of drawing methods: → p. 28
- 5 Select the desired drawing mode (**OR/NOT**).
The screen for drawing the region will be displayed.

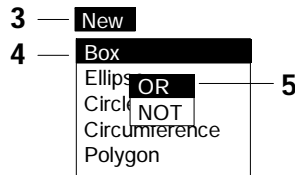

Drawing Measurement Regions and Setting Evaluation Criteria Section 3-4

6 Draw the region with the shape selected.

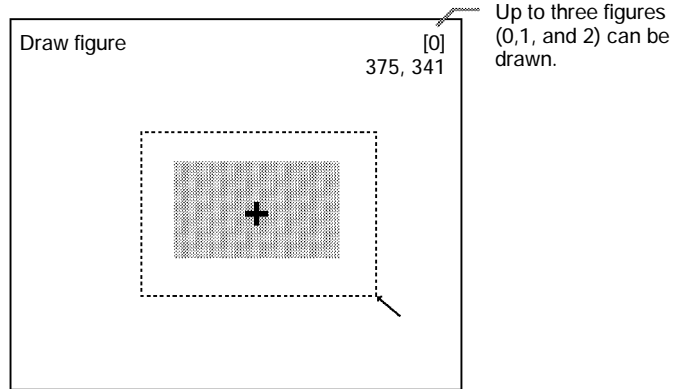

7 If additional figures are to be drawn, select **Add**. Repeat steps 4 to 6 as necessary to create the desired shape. Once 3 figures are drawn, **Add** will no longer be displayed.

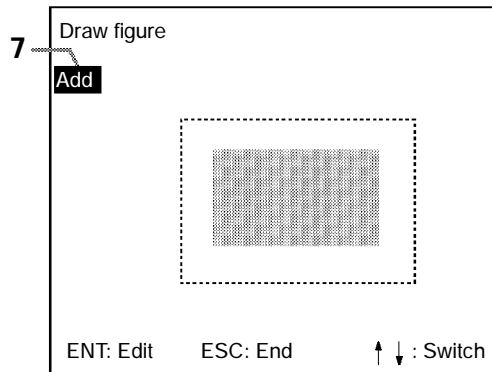

8 If the drawing for the region is finished, press the **ESC** Key while in the screen for step 7. The measurement region will be registered and the screen in step 2 will be returned. The cursor arrow will be displayed at the position of the center of gravity. If more than one figure has been drawn, the rectangle that circumscribes the figures will be displayed, and the cursor arrow will be displayed at the position of the center of gravity of this rectangle.

Drawing Measurement Regions and Setting Evaluation Criteria Section 3-4

Circumscribing Rectangle

The "circumscribing rectangle" is the smallest rectangle that contains all of the figures.

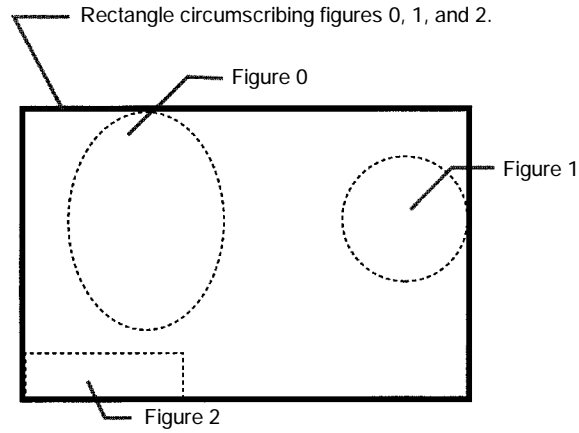

Correcting or Clearing Figures

1 In the screen for step 7 above, select the figure to be changed or cleared using the **Up** and **Down** Keys and press the **ENT** Key.

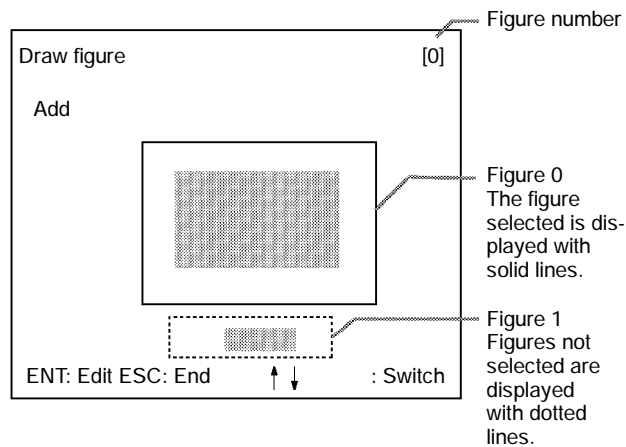

Drawing Measurement Regions and Setting Evaluation Criteria Section 3-4

2 The selections **Correct** and **Clear** will be displayed. Select the desired operation.

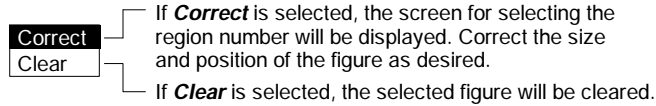

2 Setting the Evaluation Criteria

Set the range of the average density for an OK judgement.

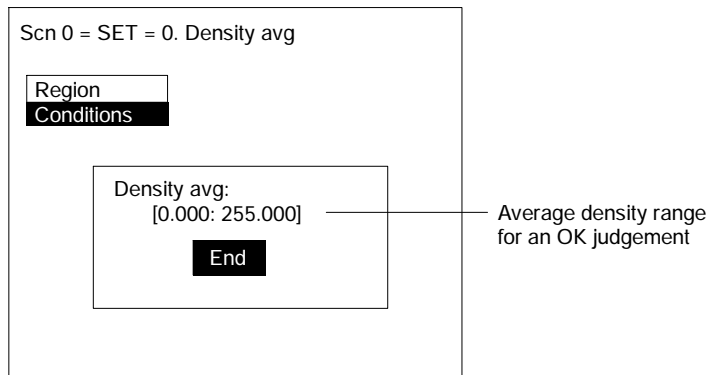

Procedure

1 Select **Conditions**.

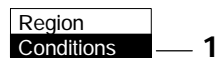

2 Set the items.

Refer to the following page for details on inputting values: → p. 26

3 Select **End** to enter the settings.

3-4-8 Relative Search

Use this method to obtain the positions of markings, holes, and other features, and to judge whether these features are within the acceptable range. This method is based on relative position so models must be registered in two positions: the measurement position and the standard position.

Drawing Measurement Regions and Setting Evaluation Criteria Section 3-4

Example: Checking the Position of a Label

The relative search function can be used to confirm the position of a label by checking the relative positions of the label and one corner of the measurement object.

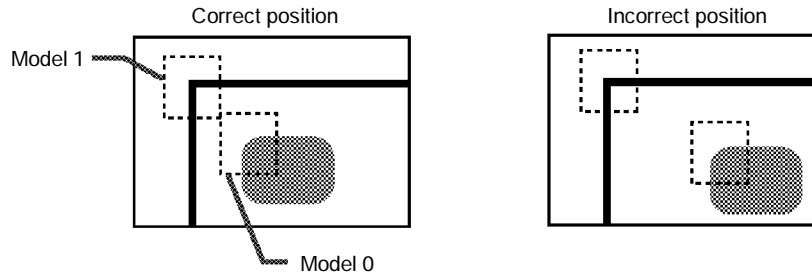

Operational Flow

- 1 Register the model.
- 2 Set the range in which a search is to be made for the model.
- 3 Set the evaluation criteria.
- 4 Change pixel-skipping parameter.
(This step is optional.)

1 Registering the Model

Register 2 models (models 0 and 1) in the places to be used as reference for measurement. The models can be of any size.

Procedure

- 1 Go to **Measurement region**/*<Region number>*/**Relative position**.
- 2 Select **Model Registration (0 or 1)**.

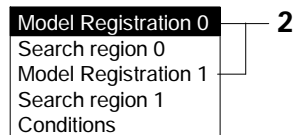

- 3 Select **New**.
- 4 Select the shape of the figure to be drawn.
Refer to the following page for details on drawing regions: → **p. 28**

Drawing Measurement Regions and Setting Evaluation Criteria Section 3-4

5 Select the drawing mode (*OR/NOT*).

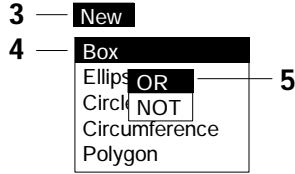

6 Draw the figure in the range desired as the model.

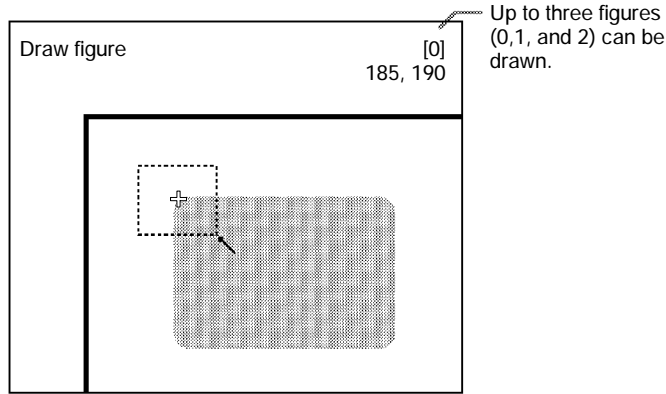

7 If additional figures are to be drawn, select **Add**.

Repeat steps 4 to 6 as necessary to create the desired shape.

Once 3 figures are drawn, **Add** will no longer be displayed.

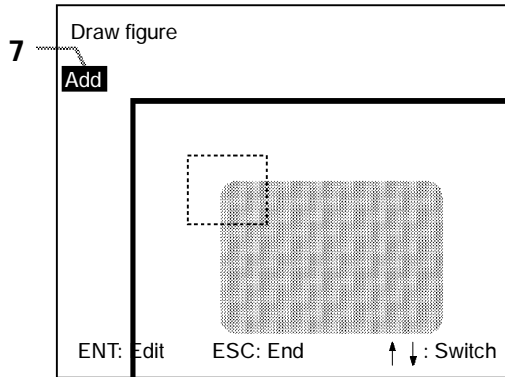

8 If the drawing for the region is finished, press the **ESC** Key while in the screen for step 7.

The arrow cursor will be displayed.

Drawing Measurement Regions and Setting Evaluation Criteria Section 3-4

- 9 Move the arrow cursor to the point whose coordinates are to be output as the search position, and press the **ENT** Key. The region is set and the screen for step 2 is returned.

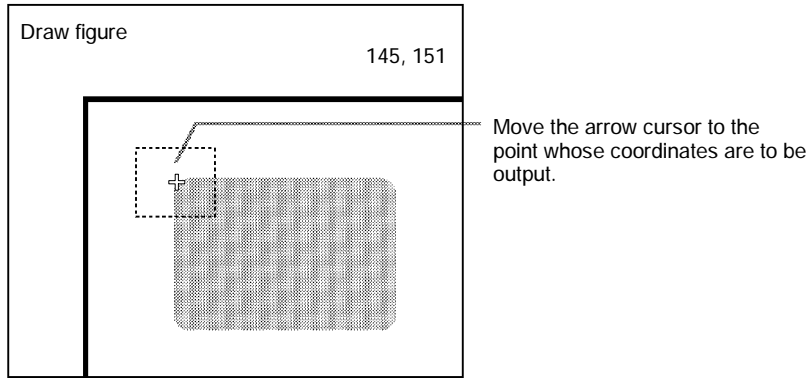

Correcting or Clearing Figures

- 1 In the screen for step 7 above, select the figure to be changed or cleared using the **Up** and **Down** Keys and press the **ENT** Key.

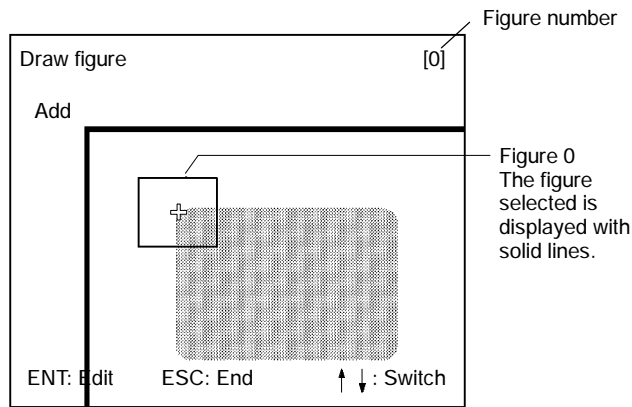

- 2 The selections **Correct** and **Clear** will be displayed. Select the desired operation.

- Correct** — If **Correct** is selected, the screen for selecting the region number will be displayed. Correct the size and position of the figure as desired.
- Clear** — If **Clear** is selected, the selected figure will be cleared.

2 Setting the Search Region

Set the region for which the model is to be searched for. It is possible to perform a search for the entire input image but processing time can be reduced and accuracy can be increased by setting limits on the search range.

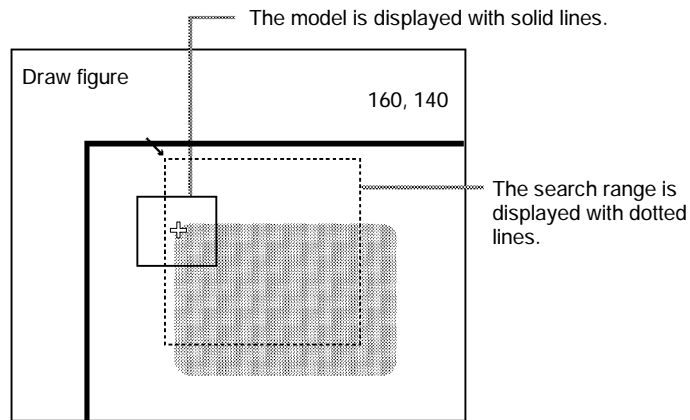

Procedure

1 Select **Search Region (0 or 1)**.

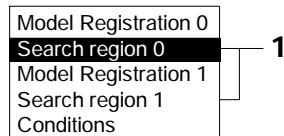

2 Draw a box-shaped search region.

When the coordinates of the lower right corner are speci-

Drawing Measurement Regions and Setting Evaluation Criteria Section 3-4

fied, the region will be registered, and the screen for step 1 will be returned.

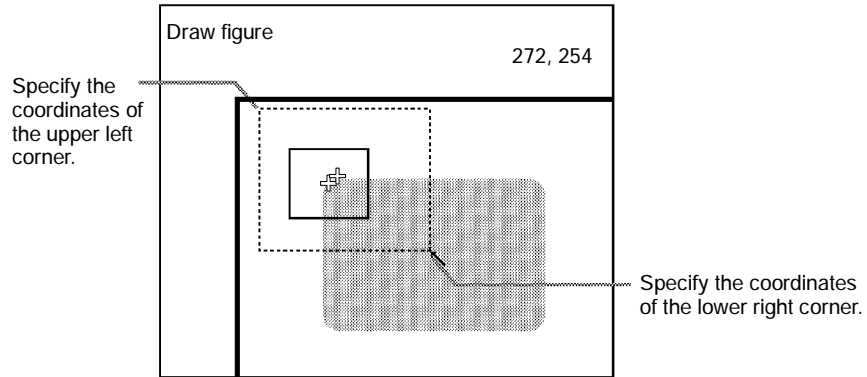

Drawing Measurement Regions and Setting Evaluation Criteria Section 3-4

3 Setting the Evaluation Criteria

Set evaluation criteria for the correlation with the model and for the relative position of model 0 and model 1.

Scn 0 = SET = 0. Relative search

Model registration 0	
S	Correlation 0: 79 [80: 100]
M	Correlation 1: 82 [80: 100]
S	Width X (1-0) : 85.351
C	[0.000: 511.000]
	Width Y (1-0) : 69.239
	[0.000: 511.000]
	Distance : 109.904
	[0.000: 511.000]
	Speed : 3B
	End

Correlation value range for an OK judgement for model 0 (0 to 100)

Correlation value range for an OK judgement for model 1 (0 to 100)

Range of difference in X direction (model 1 - model 0) for an OK judgement (-9999.999 to 9999.999)

Range of difference in Y direction (model 1 - model 0) for an OK judgement (-9999.999 to 9999.999)

Distance between model 0 and model 1 for an OK judgement (0 to 9999.999)

Search speed

LOW	Slow
1	↑
2	
3	↓
HIGH	Fast

○ Indicates measurement results for the displayed image (after calibration). Use these values as reference for setting upper and lower limits.

Correlation:

When the correlation criteria is between 70 and 100:

Image 0	Image 1	Image 0	Image 3
Correlation: 96	65	62	78
Judgement: OK	NG	NG	OK

X, Y Width, Distance:

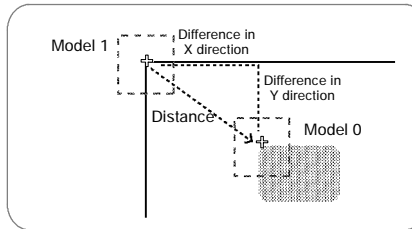

Procedure

1 Select **Conditions**.

Model Registration 0
Search region 0
Model Registration 1
Search region 1
Conditions

1

2 Set the items.

Refer to the following page for details on inputting values: → p. 26

3 Select **End** to enter the settings.

4 Changing Pixel-skipping Parameter (Optional)

The pixel-skipping parameter for searching for the model can be changed. The pixel-skipping parameter is determined according

Drawing Measurement Regions and Setting Evaluation Criteria Section 3-4

to the speed setting in the evaluation criteria menu. However, from this screen it is also possible to change the pixel-skipping parameter directly. (Note that if the pixel-skipping parameter is changed, the speed will be changed automatically.)

By making the value larger, the processing time can be reduced. However, the accuracy of the search will be reduced, and depending on the image, the object may not be found. After changing the settings, check whether measurement and search are performed properly.

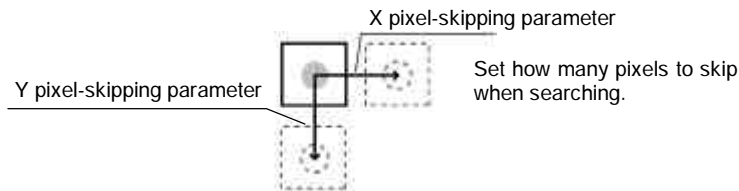

Procedure

- 1** Press the **SHIFT + ESC** Keys with the screen in this state. The screen for setting the pixel-skipping parameter will be displayed.

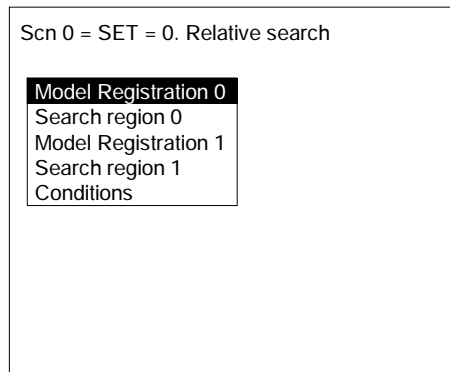

- 2** Change the pixel-skipping parameters for X and Y as desired.

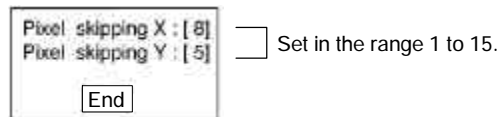

Drawing Measurement Regions and Setting Evaluation Criteria Section 3-4

- 3 Select **End**. The estimated search time for a search based on the set pixel-skipping parameters will be displayed.

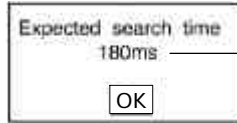

This is the estimated search time for the region number currently selected. The search time for one scene will be displayed in the upper-right corner of the screen when measurement is actually performed in Monitor mode or Run mode.

- 4 Select **OK** to enter the settings and to exit this screen.

3-4-9 Changing Settings or Clearing

The set data can be changed or cleared.

Procedure

- 1 Move the cursor to the number to be changed or cleared and press the **ENT** Key.
The selection **Change settings/Clear** will be displayed.

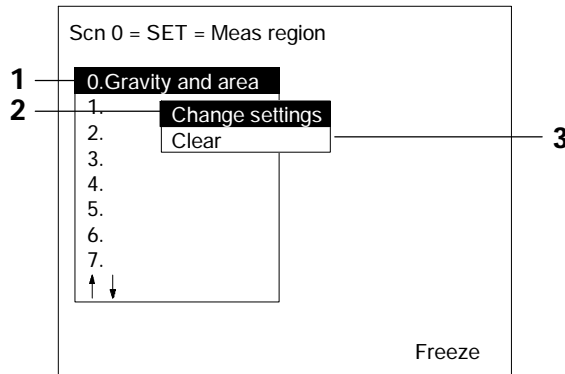

- 2 To change settings select **Change settings**.
The selections for items that can be changed will be displayed.
For details on the actual settings, refer to the explanation for the desired measurement method.
- 3 To clear all the settings select **Clear**.
A confirmation message will be displayed. Select **Execute** to clear all the settings and to exit this screen.

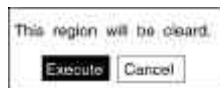

3-5 Output Expressions

This section explains how to set the contents of output made to external devices via the terminal blocks, RS-232C, or Compo-Bus/D. Output is only made when measurements are executed in Run mode. No output is made to external devices when measurements are executed in Monitor mode.

Even without setting output expressions, the judgement of the drawn region will be output to the OR terminal of the terminal blocks or OR control output of CompoBus/D.

Judgement

- The judgement for each region can be output.
- Calculations can be performed for the measurement results for each region and OK/NG judgements can be given for the results of the calculations.

The screenshot shows a terminal window with the following content:

```

Judge0
[F0.X-R1.X]
Measurement : 578908.965
Upper : [ 550000.000]
Lower : [ 600000.000]

↑ ↓.Move ENT:Change
    
```

Annotations on the right side of the screenshot:

- Output number**: 16 expressions can be set in judgement outputs 0 to 15
- Expression**: [F0.X-R1.X]
- Calculation result for displayed image**: Refer to this when setting evaluation criteria.
- Evaluation criteria**: Set evaluation conditions for the calculation result. (-9,999,999.999 to 9,999,999.999)

Data

- Measurement results can be output.
- Calculation results can be output.

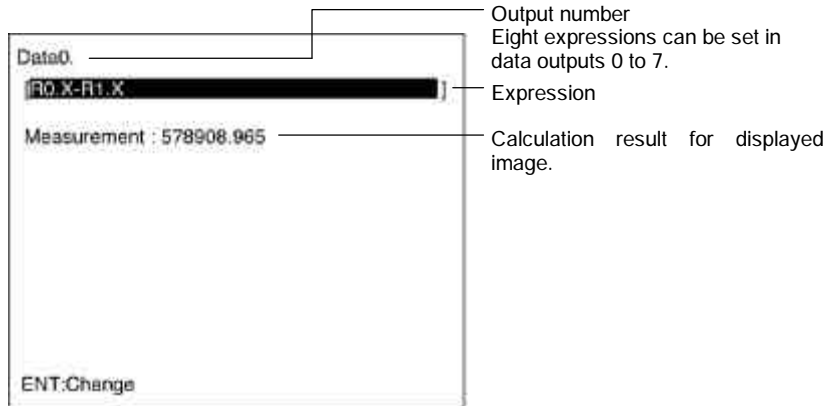

Note The destinations for judgement and data outputs are as follows:

Vision Sensor	Judgement output destination	Data output destination
F150-C10E-3 F150-C15E-3	Terminal block	RS-232C or terminal block
F150-C10E-3-DRT	CompoBus/D	CompoBus/D or RS-232C

Select the data output destination in **SYS/Output**. → p. 155

Possible Settings

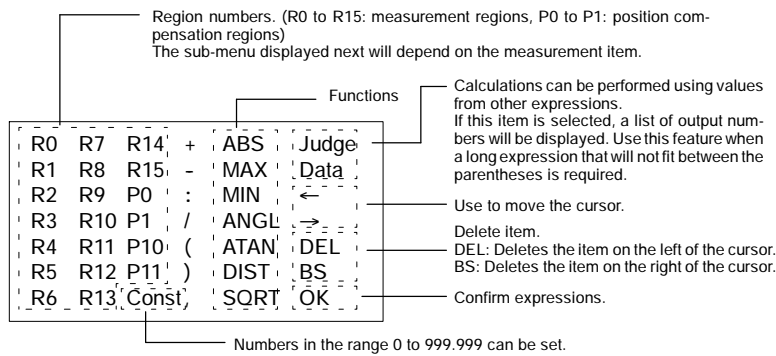

Sub-menus Displayed when R0 to 15, P0 to 1 are Selected

Center of Gravity and Area, Center of Gravity and Axis Angle

Item	Explanation
Judge JG	Judgement result
Gravity X	X coordinate of measured center of gravity
Gravity Y	Y coordinate of measured center of gravity
Reference RX	X coordinate of reference center of gravity
Reference RY	Y coordinate of reference center of gravity
Displacement DX	Measured X coordinate of center of gravity - reference X coordinate of center of gravity
Displacement DY	Measured Y coordinate of center of gravity - reference Y coordinate of center of gravity
Area MA	Area of measured object
Reference area RM	Area when region drawn
Differential area DM	Measured area - reference area
Inverted area VM	Area of measurement region - measured area
Axis angle AG (see note)	Axis angle of measured object
Reference axis RA (see note)	Axis angle when region drawn
Differential angle DA (see note)	Measured axis angle - reference axis angle

Note Axis angle, reference axis, and differential angle are only displayed when a region with center of gravity and axis angle has been selected.

Gray Edge Position

Item	Explanation
Judge JG	Judgement result
Edge EG	Coordinate of measured edge position
Reference RE	Coordinate when region drawn
Displacement DE	Coordinate of measured edge position - reference edge position

Density Averaging

Item	Explanation
Judge JG	Judgement result
Dens average D	Average density for measured region
Ref density RD	Average density when region drawn
Dens difference DD	Measured average density - reference average density

Gray Search, Precise Search

Item	Explanation
Judge JG	Judgement result
Search X	Measured X coordinate
Search Y	Measured Y coordinate
Reference RX	Reference X coordinate
Reference RY	Reference Y coordinate
Displacement DX	Measured X coordinate - reference X coordinate
Displacement DY	Measured Y coordinate - reference Y coordinate
Correlation CR	Correlation with model

Surface Defect

Item	Explanation
Judge JG	Judgement result
Defect F	Measured defect
Density MAX GA	Greatest density value inside measurement region
Density MIN GI	Smallest density value inside measurement region

Edge Pitch

Item	Explanation
Judge JG	Judgement result
Numbers N	Number of detected objects
Pitch AVG P	Average pitch of detected edges
Pitch MAX PH	Maximum pitch of detected edges
Pitch MIN PL	Minimum pitch of detected edges
Width AVG W	Average width of detected edges
Width MAX WH	Maximum width of detected edges
Width MIN WL	Minimum width of detected edges

Relative Search

Item	Explanation
Judge JG	Judgement result
Width X	Difference in measured X coordinates (model 1 - model 0)
Width Y	Difference in measured Y coordinates (model 1 - model 0)
Distance D	Measured distance
Reference RX	Difference in reference X coordinates
Reference RY	Difference in reference Y coordinates
Reference RD	Reference distance
Displacement DX	Difference in measured X coordinates - difference in reference X coordinates
Displacement DY	Difference in measured Y coordinates - difference in reference Y coordinates
Displacement DD	Measured distance - reference distance
Correlation C0	Correlation with model 0
Correlation C1	Correlation with model 1

Functions

Function	Meaning	Arguments
ABS	Gives the absolute value. <i>ABS(argument)</i>	1
MAX	Gives the larger of two arguments. <i>MAX(argument 1, argument 2)</i>	2
MIN	Gives the smaller of two arguments. <i>MIN(argument 1, argument 2)</i>	2
SQRT	Calculates the square root. If the argument is negative, the calculation result will be 0 and the judgement will be NG. <i>SQRT(argument)</i>	1

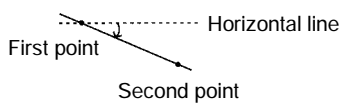
Function	Meaning	Arguments
ANGL	<p>Calculates the angle between a straight line joining two points, such as the center of gravity or the center of a model, and a horizontal line. The result will be in the range -180 to 180°.</p>  <p>ANGL(<i>Y component</i>, <i>X component</i>)</p> <ul style="list-style-type: none"> • Example: Set the following to calculate the angle between the straight line joining the center of gravity for region 0 and the center of gravity for region 1 and a horizontal line. ANGL(R1.Y-R0.Y,R1.X-R0.X) <p>If both arguments are 0, the result will also be 0 and the judgement will be NG.</p>	2
ATAN	<p>Calculates the arc tangent for the Y component/X component. The result is given as a radian of $-\pi$ to π.</p> <p>ATAN(<i>Y component</i>, <i>X component</i>)</p> <ul style="list-style-type: none"> • Example: Set the following to calculate the angle between a straight line joining the center of gravity for region 0 and the center of gravity for region 1 and a horizontal line. ATAN(R1.Y-R0.Y,R1.X-R0.X) <p>If both arguments are 0, the calculation result will also be 0 and the judgement will be NG.</p>	2
DIST	<p>Calculates the distance between two points, such as the center of gravity and the center of the model.</p> <p>DIST(<i>X coordinate of first point</i>, <i>Y coordinate of first point</i>, <i>X coordinate of second point</i>, <i>Y coordinate of second point</i>)</p> <ul style="list-style-type: none"> • Example: Set the following to calculate the distance between the center of gravity for region 0 and center of gravity for region 1. DIST(R0.X,R0.Y,R1.X,R1.Y) • The following calculation is performed internally. $\sqrt{(R1.X-R0.X)^2 + (R1.Y-R0.Y)^2}$ 	4

JG

If "JG" is set as a judgement output expression, judgement will be performed in the following two stages.

- 1 Judgement is performed for each region based on the set evaluation criteria giving a result of "0.000" (OK) or "- 1.000" (NG).

2 Judgement is performed on the judgement result (i.e.: 0.000 or -1.000), based on the upper and lower limits in the screen for the output.

If "JG" is set as a data output expression, only the judgement described in 1 above will be performed. The result of this judgement (OK: 0.000, NG: -1.000) will be directly output to the external device.

Example 1

To output judgment result for region 0 to "Judge 0":

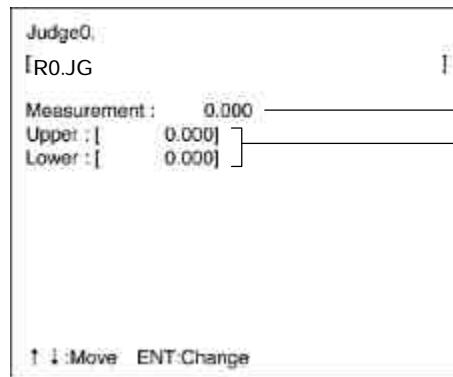

0.000: OK, -1.000: NG
 Judgement is performed according to the evaluation criteria set when region 0 was drawn.

Evaluation criteria for R0.JG
 In order that only the value 0.000 is judged OK, set both the upper and lower limits to 0.000.

Example 2

To obtain an OR judgement for regions 0 and 1:

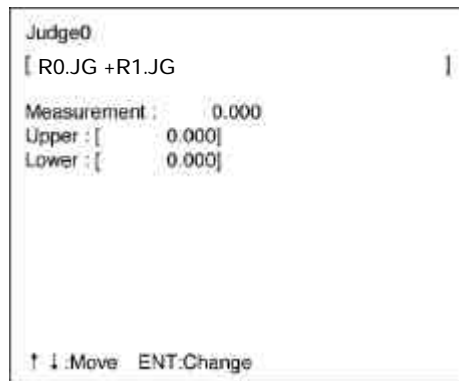

If the upper and lower limits are both set to 0.000, one of the following judgements will be made:

- If both regions receive OK judgement, the measurement result will be 0.000, so the overall judgement will be OK.
- If one region receives OK judgement, the measurement result will be -1.000, so the overall judgement will be NG.

- If both regions receive NG judgement, the measurement result will be -2.000, so the overall judgement will be NG.

Judgement and Data

It is possible to perform calculations using measurement results from other expressions. Use this feature when a long expression that will not fit between the parentheses is required. These values are displayed as "PR.0" to "PR.15" for Judge 0 to 15, and as "RS.0" to "RS.7" for Data 0 to 7.

Example 1: To obtain the length of the straight line joining 2 points and add 120.25

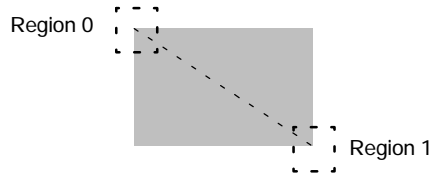

Divide the calculations into Judge 0 and Judge 1 in the following way:

Judge 0
 [DIST(R0.X,R0.Y,R1.X,R1.Y)] The constant 120.25 cannot be entered because there is not enough space.

Judge 1
 [PR.0+120.25] Add 120.25 to the calculation result of Judge 0.

PR.0 represents the calculation result of Judge 0

Note Only use expressions containing PR.j or RS.j for outputs of a higher number. Calculations are performed in the following or-

der. If PR.j or RS.j are used in expressions for outputs with a lower number, the previous calculation result will be used.

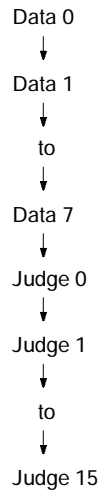

If example 1 had been constructed in the opposite order:

Judge 0
[PR.1+120.25] This will be calculated before Judge 1 and so the previous value for PR.1 will be used instead.

Judge 1
[DIST(R0.X,R0.Y,R1.X,R1.Y)]

Example 2: To output the number of measurements

In this case a value is to be output so use a data output expression.

Data 0
[RS.0+1]

Each time the Set mode is entered or the power is turned OFF, the value of RS.0 will return to 0 along with the number of measurements.

Procedure

- 1** Go to **Expression/Judge** or **Expression/Data**. The screen for selecting output numbers will be displayed.

Expression



2 Select the output number for which the expression is to be set.

0. R0. JG
1. R1. JG
2. R0.X+R1.X
3.
4.
5.
6.
7.
↑ ↓

Expressions are displayed next to the numbers for which expressions have already been set.

3 Move the cursor into the space between the parentheses for the expression and press the **ENT** Key.

Example: If **Judge** is selected.

Judge0.
[_____]

4 The list of possible settings will be displayed. Select the item to be set.

Example

Judge0.

[]
Judge	JG	S Judge
Defect	F	X Data
Max. density	GA	N ←
Min. density	GI	GL →
R4 R11 P10 (ATAN	DEL
R5 R12 P11)	DIST	BS
R6 R13 Const,	SQRT	OK

Select the item.

↓ Press the **ENT** Key.

Judge0.

[R0.JG]
R0	R7 R14 + ABS	Judge
R1	R8 R15 - MAX	Data
R2	R9 P0 : MIN	←
R3	R10 P1 / ANGL	→
R4	R11 P10 (ATAN	DEL
R5	R12 P11) DIST	BS
R6	R13 Const, SQRT	OK

The selected item will be entered in the expression.

5 When the expression has been set, select **OK**. The expression will be registered.

6 For judgement output, set the OK/NG evaluation criteria.

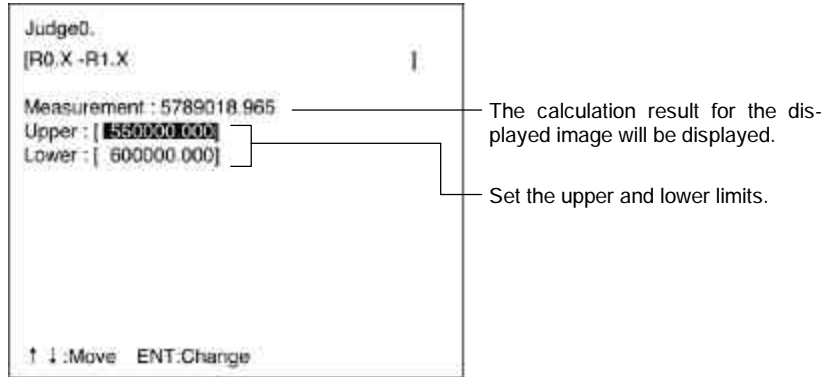

7 Press the **ESC** Key to exit this screen.
The setting will be saved and the screen for step 1 will be returned.

3-6 Scenes

3-6-1 Changing Scenes

The different situations (type of measurement object and type of measurement required) in which measurements are performed are called "scenes" and the measurement conditions set in Set mode are called "scene data." Up to 16 scenes can be set, numbered from 0 to 15 (see note). Use scenes to switch between different measurement conditions for different measurement setups or measurement objects. Scene 0 will be displayed by default when the power is turned ON. The command for changing scenes can be input via the terminal blocks or RS-232C.

Note It may not be possible to use all 16 scenes if there is a lack of available memory. In this case, a warning message will be displayed on the screen. Make regions and models as small as possible and delete any regions and models that are not required, before continuing operation.

Procedure

- 1 Display the Basic Screen for Monitor mode or Run mode.
- 2 Move the cursor to **Scn j** and press the **ENT** Key.
A list of scenes, from scene 0 to scene 8, will be displayed.

Use the **Down** Key to scroll down and display the rest of the list, from scene 9 to scene 15.

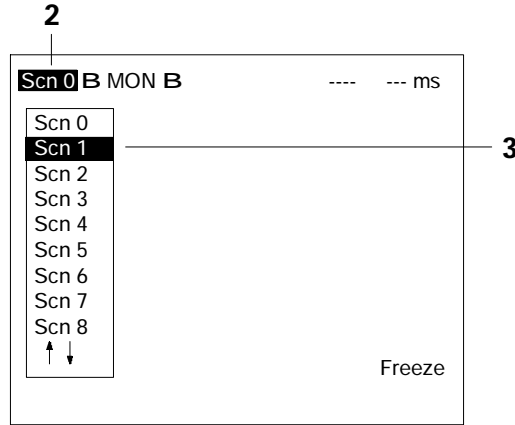

3 Using the **Up** and **Down** Keys, move the cursor to the desired scene and press the **ENT** Key. The selected scene will be displayed. After the scene has been selected, the mode will return to the original one.

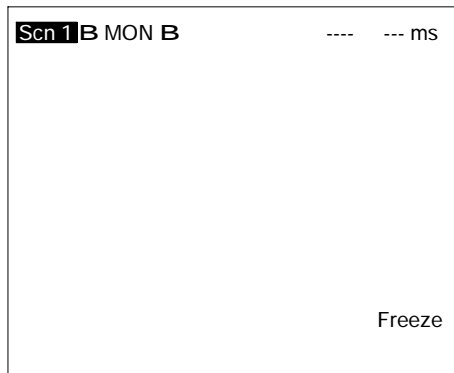

3-6-2 Copying Scene Data

This function is useful for creating new scenes by copying scene data from another scene and changing some settings to suit the new requirements.

Procedure

- 1 Move the cursor to **Scn j** and press the **ENT** Key. Scene numbers 0 to 8 will be displayed. Use the **Down** key to display scene numbers 9 to 15.

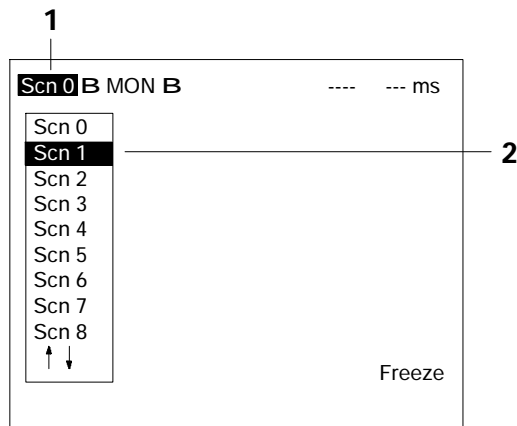

- 2 Move the cursor to the scene number to which data is to be copied, and press the **SHIFT + ESC** Keys. The **Copy/Clear** selection menu will be displayed.



- 3 Select **Copy**.
- 4 Enter the number of the scene from which data is to be copied (**Original scene**), and select **Execute**. The data will be copied.

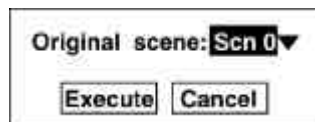

3-7 Initializing Measurement Conditions (Clearing Scenes)

Use the following procedure to clear measurement conditions set in Set mode, and to return scenes to their default settings. This procedure is performed separately for each scene.

Procedure

- 1 Move the cursor to **Scn j** and press the **ENT** Key. Scene numbers 0 to 8 will be displayed. Use the **Down** key to display scene numbers 9 to 15.

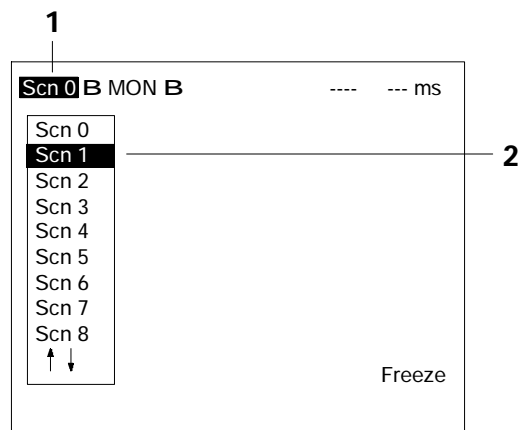

- 2 Move the cursor to the number of the scene to be cleared, and press the **SHIFT + ESC** Keys. The **Copy/Clear** selection menu will be displayed.



- 3 Select **Clear**. A confirmation message will be displayed.

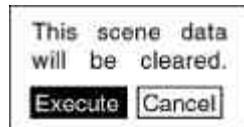

- 4 Select **Execute**. The scene will be cleared.



SECTION 4

Monitor Mode and Run Mode

This section explains how to check if measurements are being correctly performed with the set measurement conditions using Monitor mode, and how to make actual measurements using Run mode.

4-1	Confirming Correct Operation	138
4-1-1	Entering Monitor Mode	138
4-1-2	Test Measurement	139
4-1-3	Displaying Measurement Results and Changing Evaluation Criteria	142
4-2	Run Mode	151
4-2-1	Entering Run Mode	151
4-2-2	Performing Measurement	152

4-1 Confirming Correct Operation

4-1-1 Entering Monitor Mode

Use the following procedure to check that measurements are being correctly performed with the set measurement conditions.

Note The key allocations for the Console Keys used to make input can be changed. In the following explanations, it is assumed that the key allocations are at the default settings. If they are not, adapt the procedure accordingly. →p. 167

Procedure

Entering Monitor Mode from Set Mode

In Set mode, press the **ESC** Key to leave Set mode and enter Monitor mode.

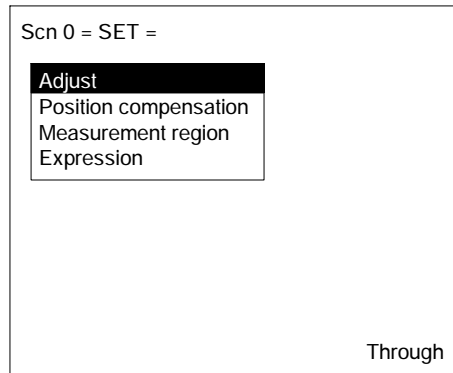

↓ Press the **ESC** Key.

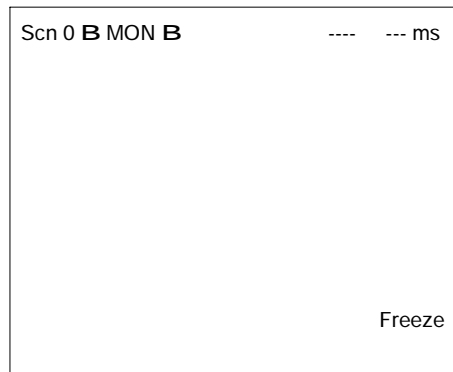

Entering Monitor Mode from Run Mode

- 1 Move the cursor to **RUN** and press the **ENT** Key.
The mode selections will be displayed.

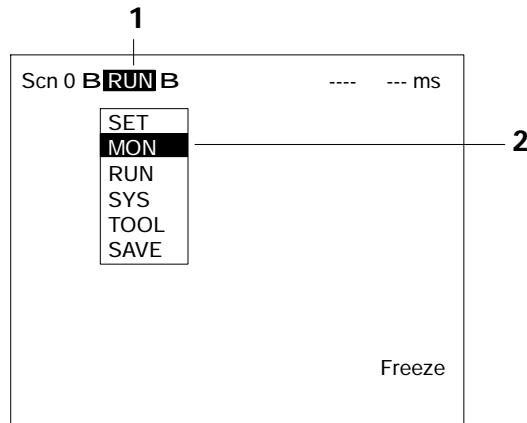

- 2 Select **MON** to enter Monitor mode.

4-1-2 Test Measurement

Use the following procedure to execute measurement according to the conditions set for the scene currently displayed. The measurement results are not output via the terminal blocks or RS-232C and so this procedure only tests operation for the F150 itself. The measurement command can be input, however, via the terminal blocks, RS-232C, or CompoBus/D.

Procedure Press the TRIG Key on the Console or input the measurement command from an external device.

Measurement will be executed and the measurement results displayed on the screen.

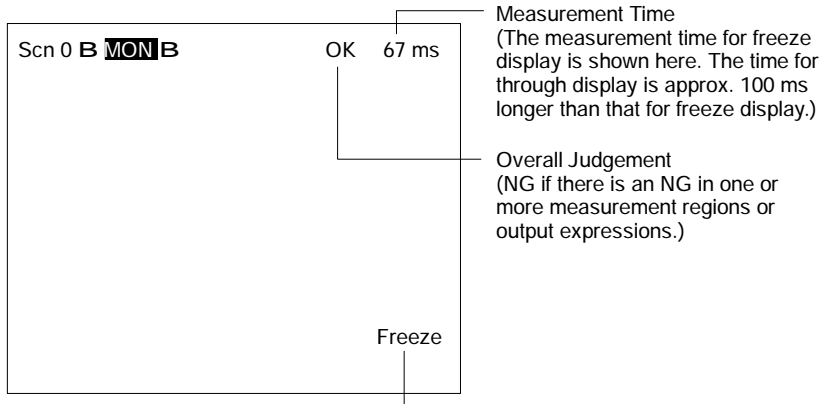

Press the **SHIFT** Key together with the **Up/Down** Keys to switch display image. →p. 164

Two-camera Operation

If the camera mode is Two-camera Switching mode, switch between Camera 0 images and Camera 1 images by pressing the

SHIFT + Up/Down Keys. The camera number is displayed in the lower right corner of the screen.

Camera 0 image

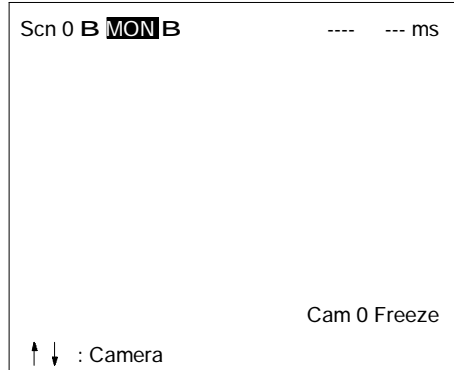

Camera 1 image

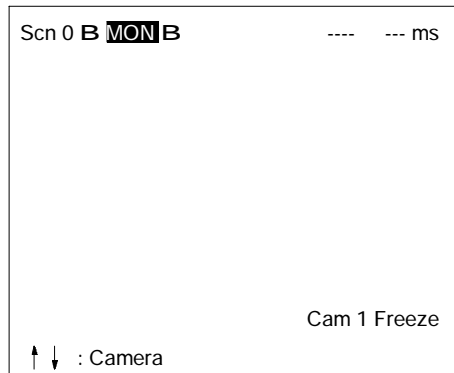

Press the **SHIFT** Key together with the **Up/Down** Keys to switch display image (including memory images).

- Note**
1. Storing Measured Images to Memory
 Up to 23 screens can be stored to memory. Once 23 screens have been stored, the existing screens will be overwritten in order starting with the oldest.
 To store measured images to memory, go to **Display settings** by pressing the **SHIFT + ESC** Keys, and make the appropriate settings for **Image storage**. To store NG images only, select **Only NG**, and to store images regardless of the judgement result, select **All**. →p. 160
 2. Repeating Measurement for Images in Memory
 Measurement can be repeated for images stored to memory.
 Display the desired memory image using the **SHIFT + Up/**

Down Keys and press **SHIFT + TRIG** Keys to execute measurement. Measurement can also be repeated for freeze images without re-inputting the image using the **SHIFT + TRIG** Keys. This feature can be used after evaluation criteria have been changed to check that the new criteria are appropriate.

4-1-3 Displaying Measurement Results and Changing Evaluation Criteria

The data that is displayed on the screen can be changed. Also, the evaluation criteria can be adjusted while referring to measurement results.

Go to **Display settings** by pressing the **SHIFT + ESC** Keys, and change the settings for **Display result**.

None (Default Setting)

If **Display result** is set to **None**, only the overall judgement will be displayed.

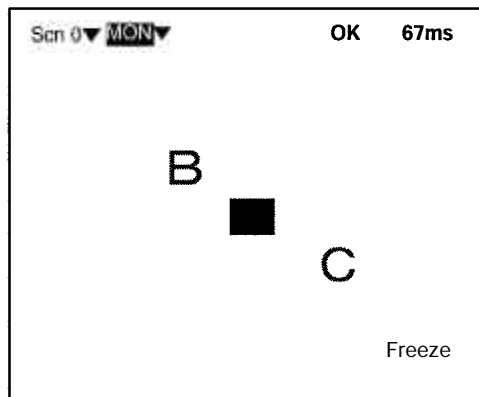

Two-camera Operation

If the camera mode is Two-Camera Switching mode, switch between Camera 0 images and Camera 1 images using the **Up/Down** Keys.

All Results of Regions

Judgement results for all the regions are displayed in one list.

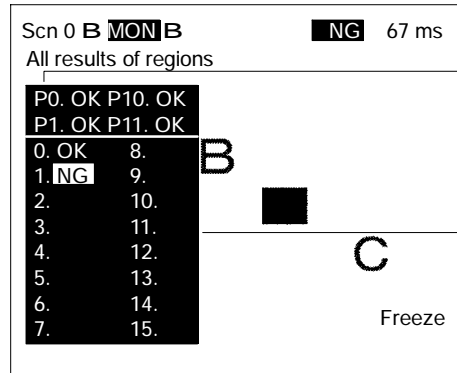

P0, P1, P10, P11:
Position compensation regions
(P10 and P11 are for Camera 1
when the Two-camera Unit is used.)

0 to 15: Measurement regions

Press the **SHIFT + Left/Right** Keys
to change the brightness of the
background (dark ↔ clear).

**Two-camera
Operation**

If the camera mode is Two-camera Switching mode, switch between Camera 0 images and Camera 1 images using the **Up/Down** Keys.

Position Compensation

The results for position displacement compensation can be displayed. There are screens for displaying the results for each position compensation region and a screen for displaying the displacement distance. Use the **Up** and **Down** Keys to switch between the screens. The image displayed is the image after filtering and background suppression for position displacement compensation.

Results for each position compensation region:

Displacement distance (difference between the reference position and the measurement position):

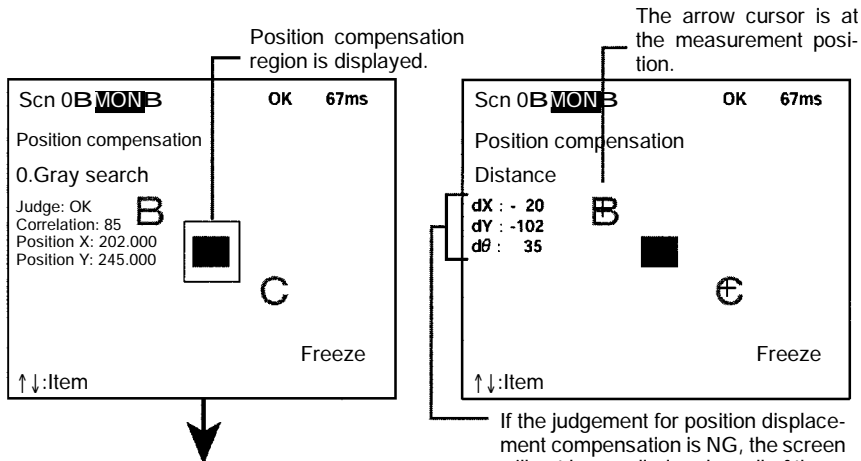

If the **SHIFT + ENT** Keys are pressed from the screen for the individual region, the screen for changing conditions will be displayed, and the evaluation criteria can be changed while monitoring the measurement values. However, even if a trigger or a STEP signal is input, measurement will not be performed while this screen is displayed.

If the judgement for position displacement compensation is NG, the screen will not be scrolled and so all of these values will be 0.

Confirming Correct Operation

Section 4-1

Two-camera Operation If the camera mode is Two-camera Switching mode, use the **Up/Down** Keys to switch screens in the way shown below.

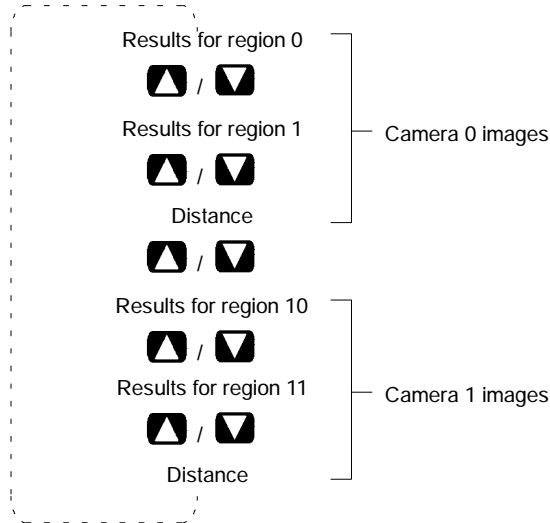

All Positions of Regions

Outlines of all the set measurement regions are displayed.

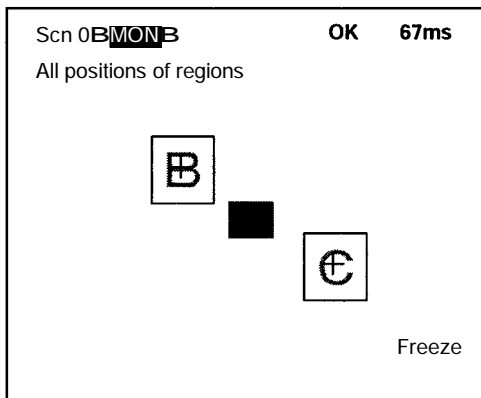

If a figure other than a box (such as a circle or polygon) is set, or if more than one figure is set for one region, only the circumscribing rectangle is displayed.

Two-camera Operation If the camera mode is Two-camera Switching mode, switch between Camera 0 images and Camera 1 images using the **Up/Down** Keys.

Individual Region

The measurement values for each region are displayed separately. Use the **Up/Down** Keys to switch to screens for different regions. If the **SHIFT + ENT** Keys are pressed from this screen, the screen for changing conditions will be displayed, and the evaluation criteria can be changed while monitoring the measurement values. However, even if a trigger or a STEP signal is input, measurement will not be performed while this screen is displayed.

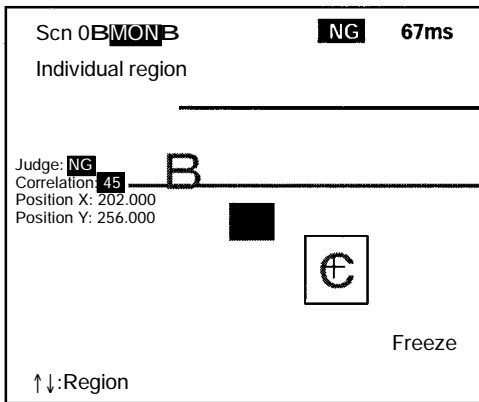

Switch regions with the **Up/Down** Keys.

Inverted display is used for NG items.

All Judges

Judgement results for the judgement output expressions are displayed in one list.

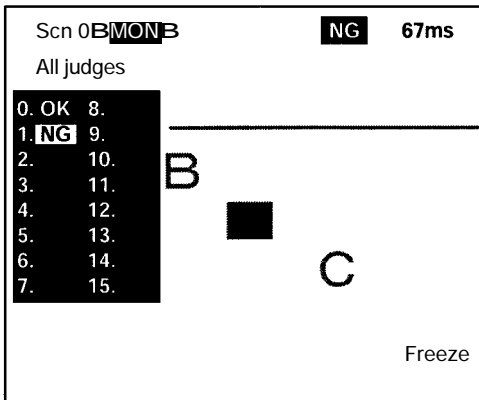

Pressing **SHIFT + Left/Right** Keys to change the brightness of the background (dark ↔ clear).

Two-camera Operation

If the camera mode is Two-camera Switching mode, switch between Camera 0 images and Camera 1 images using the **Up/Down** Keys.

All Data Measurement results for the data output expressions are displayed in one list.

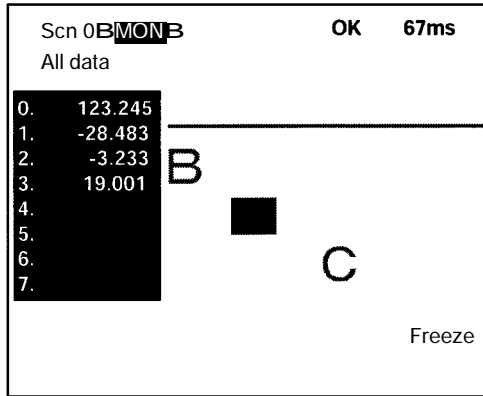

Pressing **SHIFT + Left/Right** Keys to change the brightness of the background (dark ↔ clear).

Two-camera Operation If the camera mode is Two-camera Switching mode, switch between Camera 0 images and Camera 1 images using the **Up/Down** Keys.

Individual Judge, Individual Data

Calculation results for the each of the output expressions are displayed individually. Use the **Up/Down** Keys to switch to screens for different expressions. If the **SHIFT + ENT** Keys are pressed from this screen, the screen for changing conditions will be displayed, and the evaluation criteria can be changed while monitoring the calculation results. However, even if a trigger or a STEP signal is input, measurement will not be performed while this screen is displayed.

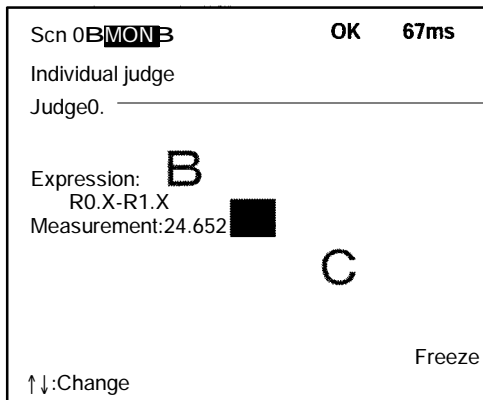

Switch the displayed item using the **Up/Down** Keys.
Individual judge (0 to 15)
Individual data (0 to 7)

Two-camera Operation If the camera mode is Two-camera Switching mode, use the **Up/Down** Keys to switch screens in the way shown below.

Example: When Judge 0 and Judge 1 are set

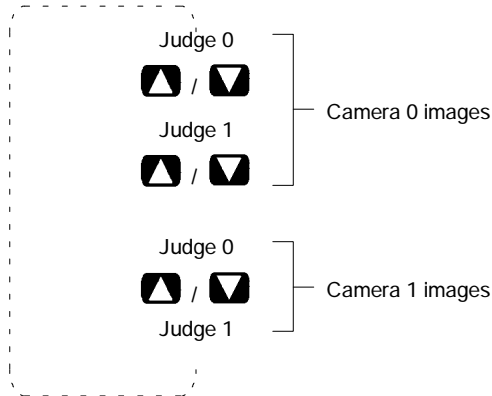

I/O Monitor The contents of input made from external devices to the F150 and the contents of output made from the F150 to external devices can be displayed. (The contents of output are only possible in Run mode.)

Only I/O transferred via the terminal blocks and RS-232C in Normal communications mode can be displayed. It is not possible to display I/O transferred via CompoBus/D or RS-232C in Host Link communications mode.

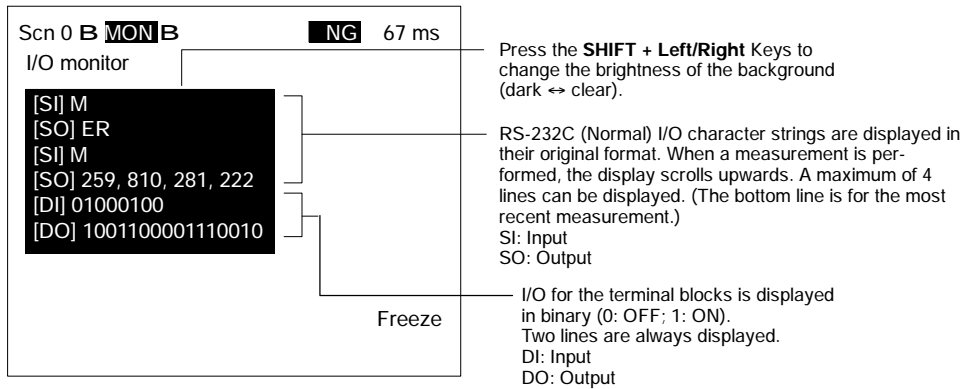

Two-camera Operation If the camera mode is Two-camera Switching mode, switch between Camera 0 images and Camera 1 images using the **Up/Down** Keys.

Cyclic Monitoring

Region, **Judge**, **Data**, and **All** are sets of several display items that can each be displayed cyclically using the **Up/Down** Keys. By using this function, it is not necessary to press the **SHIFT + ESC** Keys and change the settings in **Display settings**. The combinations and the order in which they are displayed are shown below.

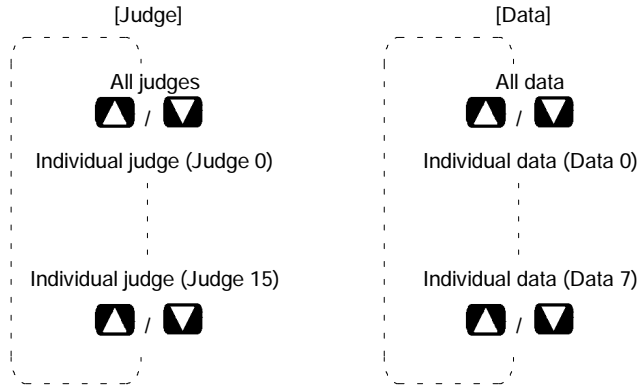

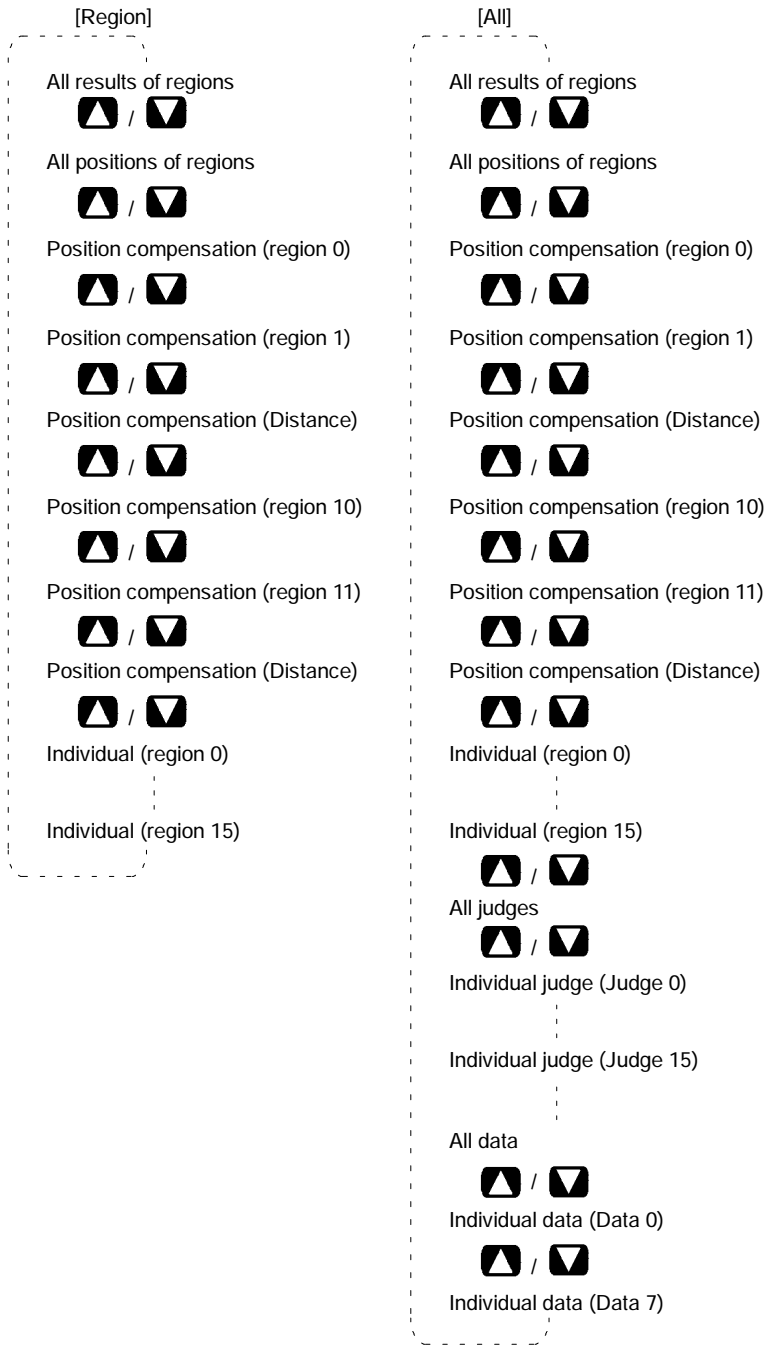

Two-camera Operation

If the camera mode is Two-camera Switching mode, the screens for Camera 0 and Camera 1 are displayed in order.

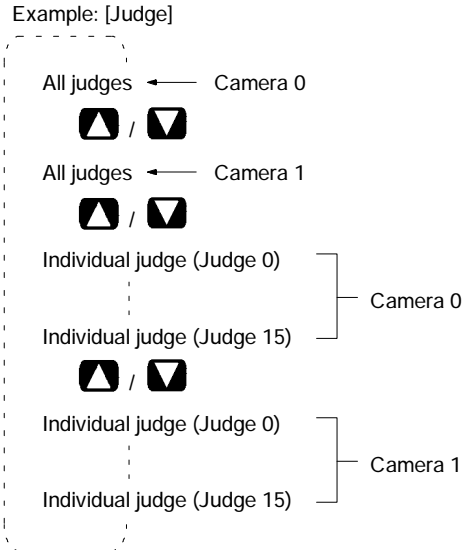

4-2 Run Mode

4-2-1 Entering Run Mode

Use Run mode to perform actual measurements.

Note The key allocations for the Console Keys can be changed. In the following explanation, it is assumed that the key allocations are at the default settings. If they are not, adapt the procedure accordingly. →p. 167

Procedure

- 1 Move the cursor to **MON** and press the **ENT** Key.
The mode selections will be displayed.

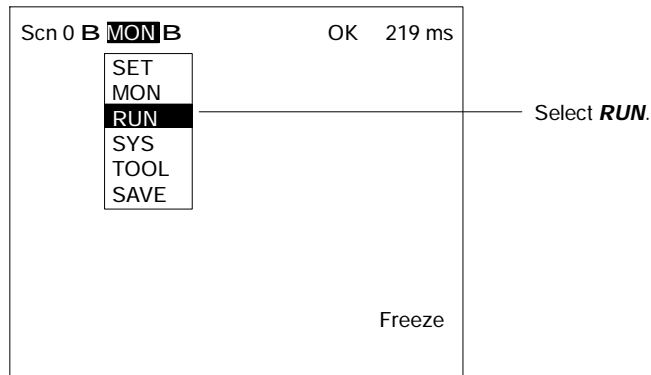

- 2 Select **RUN** to enter Run mode.

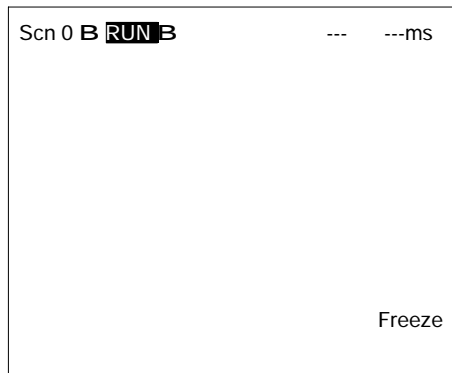

4-2-2 Performing Measurement

Use the following procedure to execute measurement according to the conditions set for the scene currently displayed.

Procedure

Press the TRIG Key on the Console or input the measurement command from an external device. Measurement will be executed and the measurement results will be displayed on the screen and output to external devices. Apart

from measurement commands, it is also possible to input various other commands from external devices.

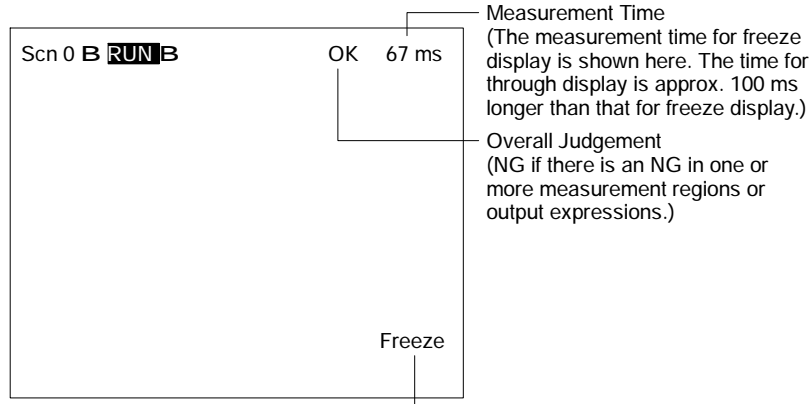

Press the **SHIFT** Key together with the **Up/Down** Keys to switch display image. →p. 164

Input Commands

Via the Terminal Block →p 185

Via the RS-232C Port, Normal Communications →p 203

Via the RS-232C Port, Host Link Communications →p 239

Via CompoBus/D →p 276

Output Formats

Via the Terminal Block →p 186

Via the RS-232C Port, Normal Communications →p 205

Via the RS-232C Port, Host Link Communications →p 260

Via CompoBus/D →p 299

Note

1. Storing Measured Images to Memory

Up to 23 screens can be stored to memory. Once 23 screens have been stored, the existing screens will be overwritten in order starting with the oldest.

To store measured images to memory, go to **Display settings** by pressing the **SHIFT + ESC** Keys, and make the appropriate settings for **Image storage**. To store NG images only, select **Only NG**, and to store images regardless of the judgement result, select **All**. →p. 160

2. Repeating Measurement for Images in Memory

Measurement can be repeated for images stored to memory.

Display the desired memory image using the **SHIFT + Up/**

Down Keys and press **SHIFT + TRIG** Keys to execute measurement. Measurement can also be repeated for freeze images without re-inputting the image using the **SHIFT + TRIG** Keys. This feature can be used after evaluation criteria have been changed to check that the new criteria are appropriate.

3. Displaying Measurement Results

To display measurement results on the screen, go to **Display settings** by pressing the **SHIFT + ESC** Keys. For further details, refer to the section on Monitor mode. → **p 140**

 **Caution** The lighting will become progressively darker if used for long periods. Make periodic adjustments to the evaluation criteria. The lighting will lose approximately 20% illumination after 1,500 hours of use.



SECTION 5

System Settings

This section explains how to set conditions related to the system environment.

5-1	Entering System Mode	156
5-2	Measurement Result Output Destinations	157
5-3	Two-camera Unit and Intelligent Light Source	158
5-4	Measurement Screen Settings	160
5-5	Storing Measured Images	162
5-5-1	Image Storage Function	162
5-5-2	Memory Storage Conditions	164
5-5-3	Displaying Stored Images	166
5-6	Changing Console Key Allocations	169
5-7	Setting Startup Conditions	172
5-8	Selecting Output Method for Error Terminal	174
5-9	Checking the Software Version	175

5-1 Entering System Mode

To set conditions related to the system environment it is necessary to enter System mode.

Procedure

- 1 Display the Basic Screen for Monitor mode or Run mode.



- 2 Move the cursor to **MON** and press the **ENT** Key.

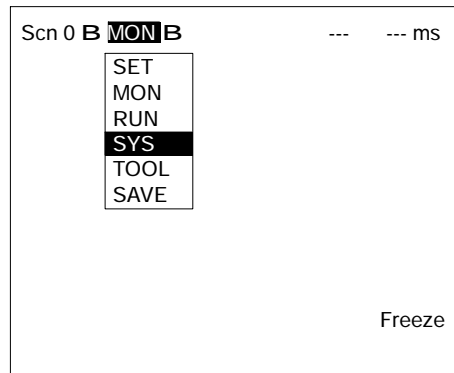

- 3** Select **SYS**.
The system menu will be displayed.

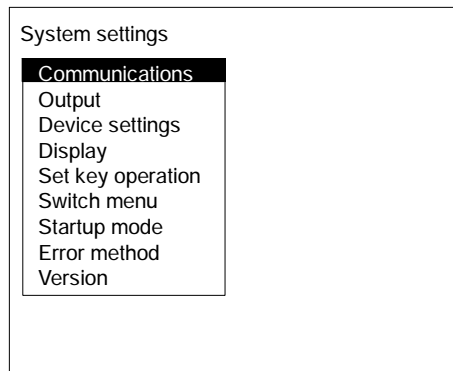

5-2 Measurement Result Output Destinations

The F150 can output judgements and data for measured objects to an external device. Use the following procedure to select the destination for judgment output and data output.

Output item	Output destination	
	F150-C10E-3-DRT	F150-C10E-3, F150-C15E-3
Judgement	CompoBus/D (fixed)	Terminal block (fixed)
Data	CompoBus/D* or RS-232C	RS-232C* or terminal block

Default settings are indicated with an asterisk.

Note Set the contents for the outputs in *Expression*. → p. 121

Procedure

1 Go to **SYS/Output**.

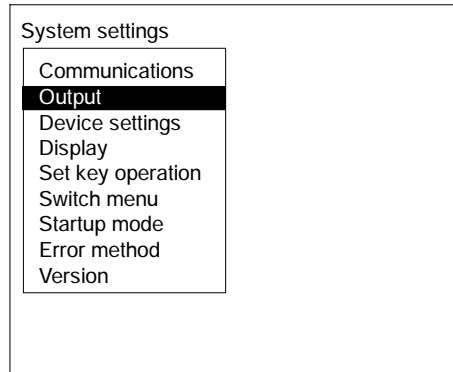

2 Select the output destinations.

F150-C10E-3-DRT

F150-C10E-3, F150-C15E-3

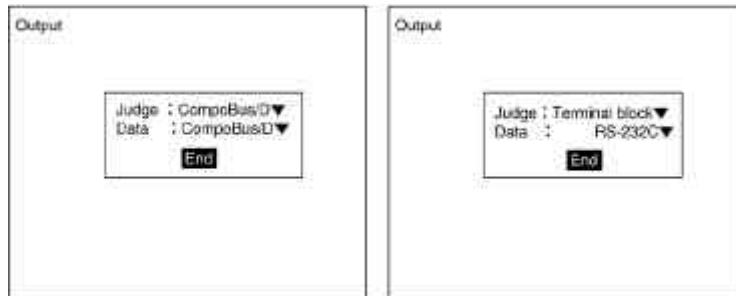

3 Select **End** to enter the settings and to exit this screen.

5-3 Two-camera Unit and Intelligent Light Source

If a Two-camera Unit or an Intelligent Light Source are used, make the settings shown below to change the menu configuration for System mode. Refer to the following page for details of the menu configuration when a Two-camera Unit is connected to the F150: → p. 13

- Note** 1. If, after setting measurement conditions for operation with just one Camera, a Two-camera Unit is connected and the settings given here are made, the original settings will be made automatically for Camera 0.

2. There are DIP switches on the Intelligent Light Sources for setting the unit number. Set the unit number for the Intelligent Light Source connected to Camera 0 to 0 and set the unit number for the Intelligent Light Source connected to Camera 1 to 1. → p. 43

Procedure

- 1 Enter System mode and select **Device settings**.

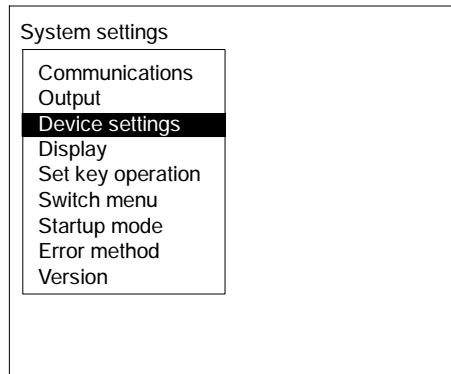

- 2 Make the required settings for the Two-camera Unit or the Intelligent Light Source.

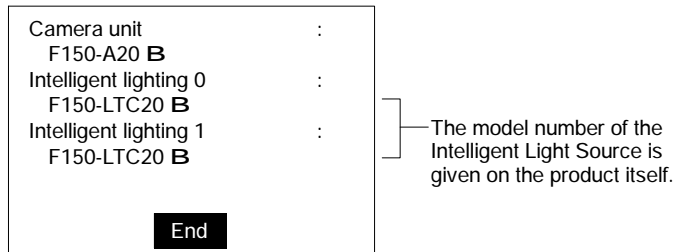

- 3 Select **End** to enter the settings.

5-4 Measurement Screen Settings

Set the items below to determine the information displayed in Run mode and Monitor mode.

Item	Details	
Display image	Select the display status for the screen.	
	Freeze (default setting)	Displays a still image (updated each time a measurement is performed.) When inspecting moving objects, select "freeze."
	Through	Displays the image currently being taken by the Camera. If measurement is performed in through state, there is a delay of approx. 100 ms between the time the measurement command is input and the time image input processing starts. Therefore, the time of measurement will be delayed by the same amount. This delay is included in the measurement time displayed in Monitor mode and Run mode.
Display result	Select the data displayed for measurement results. For details refer to the section on Monitor mode. → p. 140	
Image storage	Select the conditions for storage of measured images.	
	None (default setting)	Nothing stored.
	Only NG	Only images with NG judgements are stored. (However, the most recent image is stored regardless of the judgement.)
All	All images are stored regardless of the judgement.	

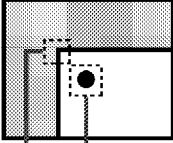
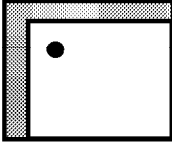
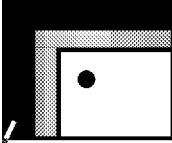
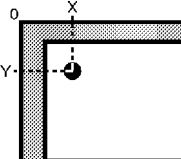
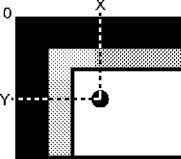
Item	Details	
<p>Coordinate calculation</p>	<p>Select the coordinates for output. Example:</p> <div style="display: flex; justify-content: space-around; align-items: flex-start;"> <div style="text-align: center;"> <p>Reference position</p>  <p>The coordinates of the center of gravity of this mark are obtained. This corner is used as the model for position compensation.</p> </div> <div style="text-align: center;"> <p>Measured image (before position compensation)</p>  <p>In the above example, the image is displaced up and to the left.</p> </div> <div style="text-align: center;"> <p>Image after position compensation</p>  <p>Part of screen outside image is black.</p> </div> </div>	
<p>Before scroll (default setting)</p>	<p>Output made using the coordinate values before position displacement compensation. (The screen selected in Display image is displayed.)</p>	
<p>After scroll</p>	<p>Output made using the coordinate values after position displacement compensation. (The screen selected in Display image is displayed.)</p>	

Procedure

1 Go to **SYS/Display**.

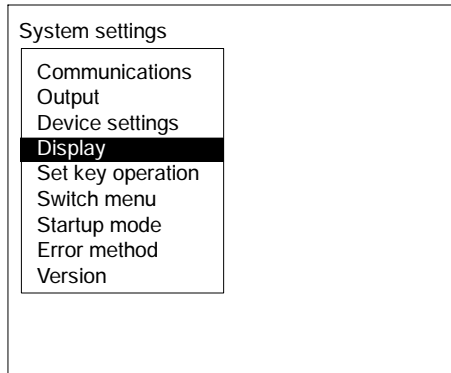

2 Set the conditions.

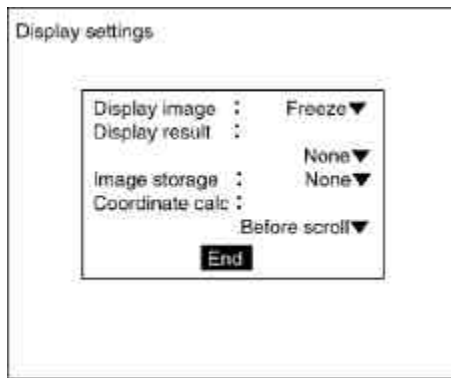

3 Select **End** to enter the settings and to exit this screen.

5-5 Storing Measured Images

The F150 can store up to 23 measured images (for all 16 scenes together). It is possible to set the F150 to only store images which resulted in NG judgements, or to store all images regardless of the measurement result.

5-5-1 Image Storage Function

Measured images that correspond to the set conditions are stored in the order "last 1," "last 2" and so on. Once 23 screens

have been stored, the existing screens will be overwritten in order starting with the oldest.

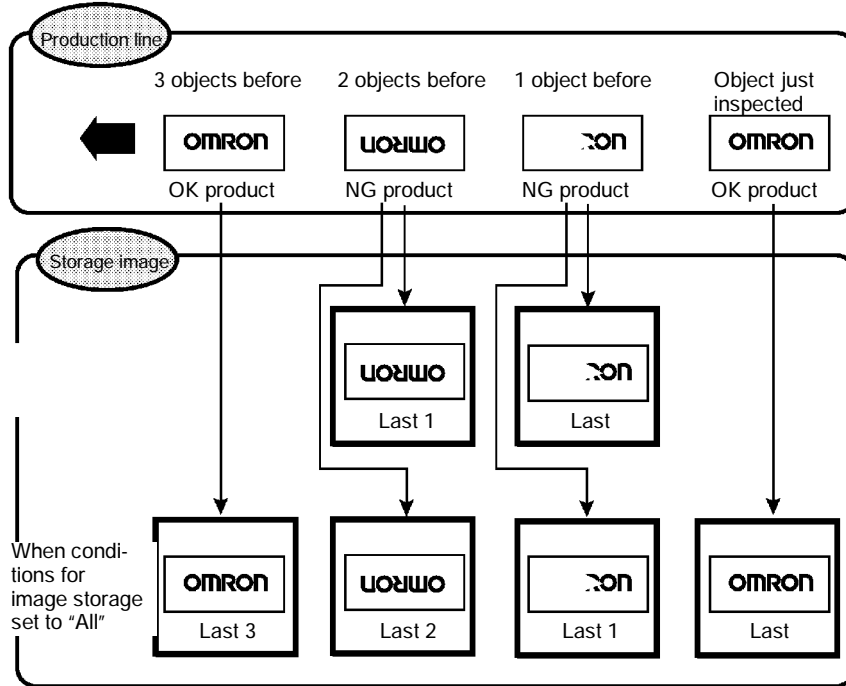

- Note**
1. Stored images are cleared when the power is turned OFF. Save the images by backing them up to a personal computer. → **p. 176**
 2. It is possible to set the Console Keys allocations so that memory images can be cleared by simply pressing one key. → **p. 167**

5-5-2 Memory Storage Conditions

Procedure

1 Enter System mode and select **Display**.

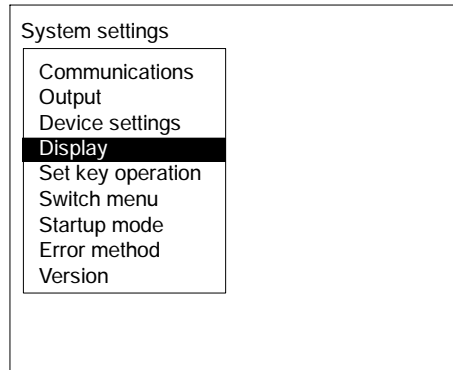

2 Set **Image storage** as desired.

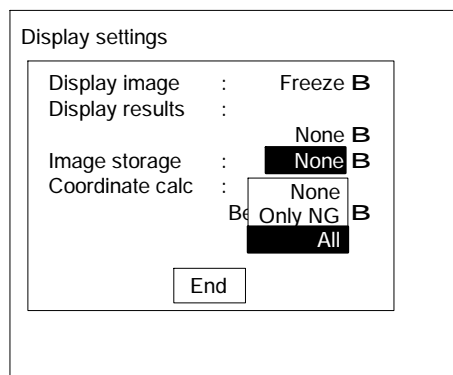

3 Select **End** to enter the settings.

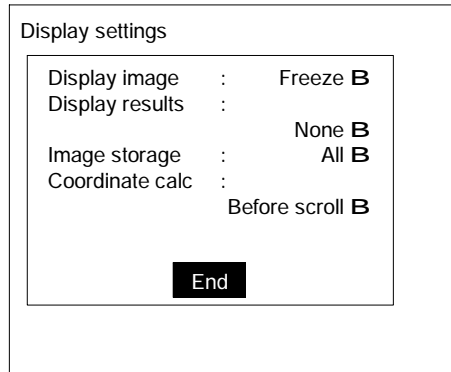

Two-camera Operation

If the camera mode is Two-camera Switching mode, the images for both Camera 0 and Camera 1 are stored with each measurement.

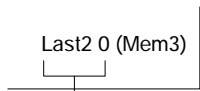

Image for Camera 0 stored 2 measurements before.

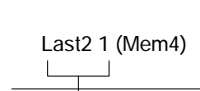
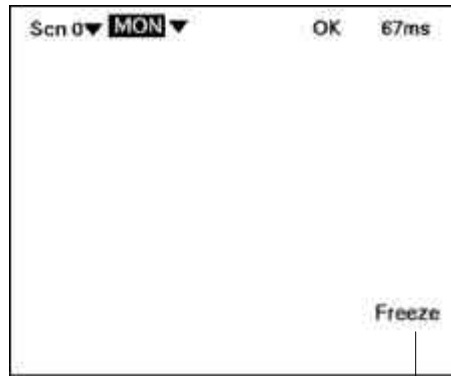

Image for Camera 1 stored 2 measurements before.

5-5-3 Displaying Stored Images

By displaying a stored image on the screen, the reason for a previous NG judgement can be checked. Also, measurement can be re-performed on the stored image with different evaluation criteria. The message in the lower-right corner of the screen indicates the type of image being displayed.



Refer to the following table.

Display	Details
Freeze	The image that has just been measured is displayed. Whether this image is a freeze image or a through image depends on the settings in <i>SYS/Display</i> .
Through	
_(Mem j)	A previously stored image is displayed. Up to 24 (Mem 0 to 23) images are stored in accordance with the conditions for storage of measured images (only NG or All). When the image is to be backed up to a personal computer, specify a memory number in j .
Last(Mem j)	The measured image most recently stored is displayed. If this image had an NG judgement, "Last" will be in reverse black/white.
Last * (Mem j)	The * after "Last" contains the number indicating how many screens previously the image was stored. Up to 23 previous images can be displayed. "Last *" will be displayed in reverse black/white for NG images.
...(Mem j)	Either no image is stored in memory, or an image other than a measurement image (an image loaded from a personal computer) is displayed.

Example

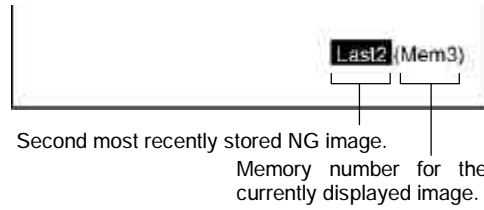

Switching Method

In Monitor mode, Run mode, or from **SET/Position compensation** or **SET/Measurement region**, press the **SHIFT + Up/Down** Keys to switch between images.

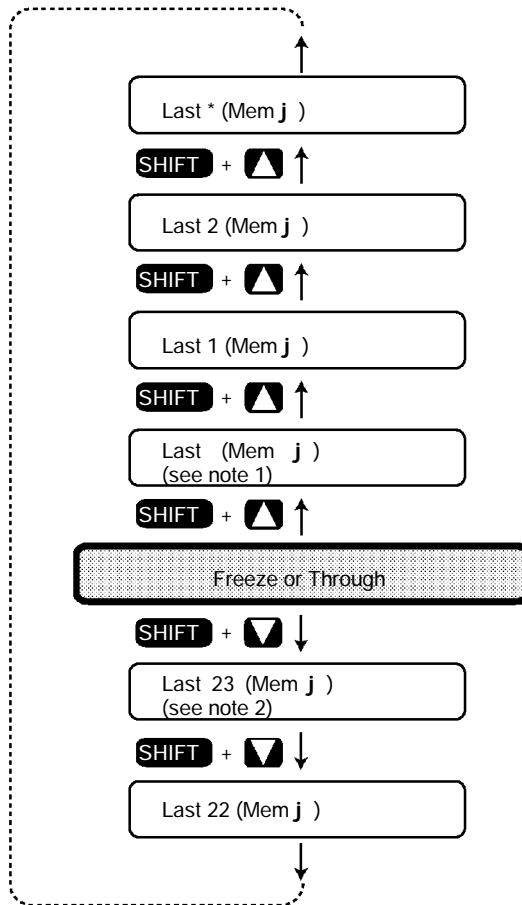

- Note**
1. Under the following conditions, the images for "Last (Mem j)" and "Freeze" will be the same.
Display image: Set to freeze.
Image storage: Set to all.
or
Display image: Set to freeze.
Image storage: Set to only NG.
Last measurement was NG.
 2. If the following conditions hold, the number of stored images will not exceed 22.
Image memory: Set to only NG
Last measurement was OK.

Two-camera Operation If the Two-camera Unit is used and the camera mode is Two-camera Switching mode, in Monitor mode or Run mode the

memory images for the Camera currently displayed are displayed in order.

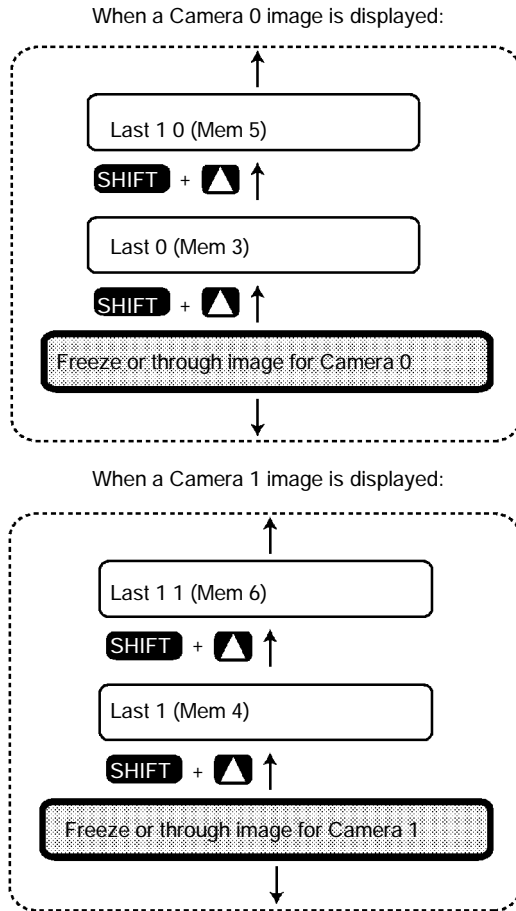

5-6 Changing Console Key Allocations

It is possible to change the allocations for Console Key operations. The set allocations are only enabled in Monitor mode or Run mode.

Item	Function
<i>None</i>	Nothing allocated
<i>Display settings</i>	Displays the SYS/Display settings screen
<i>Previous image</i>	Displays the previous memory image
<i>Next image</i>	Displays the next memory image
<i>Change background</i>	Changes the brightness of the background (dark ↔ clear) for screens displaying lists of results (Can only be used for All results of regions , All judges , All data , and I/O monitor .)
<i>Judge conditions</i>	Displays the screen for setting evaluation criteria
<i>Previous scene</i>	Displays the previous scene
<i>Next scene</i>	Displays the next scene
<i>I/O monitor</i>	Displays the I/O Monitor Screen
<i>Clear images</i> (See note 1.)	Displays a confirmation message from which all stored images can be cleared
<i>Erase characters</i> (See note 2.)	Displays the menu for character display settings
<i>Save</i> (See note 3.)	Displays a confirmation message for saving to flash memory

Note 1. Clearing Stored Images

A message confirming whether all stored images are to be cleared is displayed. Images stored in memory are cleared when power is turned OFF. By allocating this function to a Console Key, stored images can be cleared without turning power OFF.



2. Erasing Characters

To prevent scorching of the monitor screen, it is possible to delete screen characters.

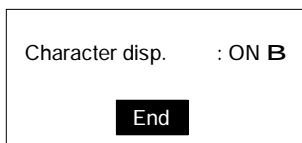

3. Save

Save settings by making a backup copy of data to flash memory before turning power OFF.

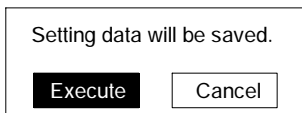

The default settings are shown below.

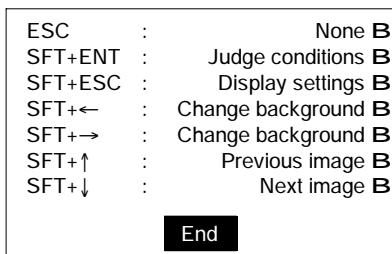

Procedure

1 Enter System mode and select **Set key operation**.

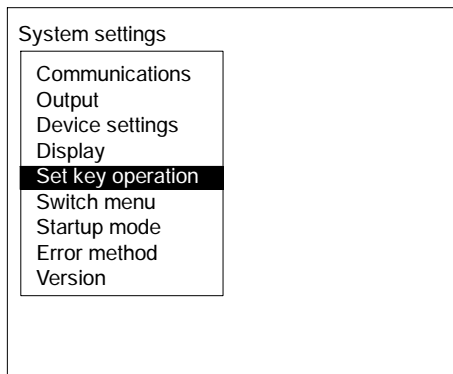

2 Change the key allocations as desired.

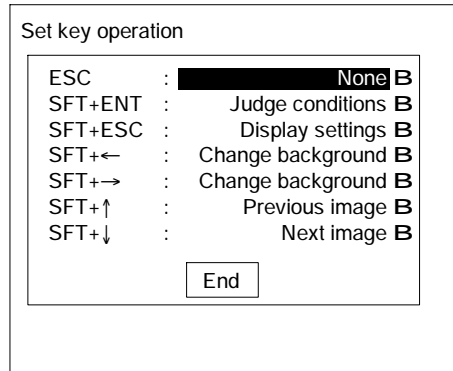

3 Select **End** to enter the settings.

5-7 Setting Startup Conditions

Use the following procedure to set the startup scene and mode that will be used when the power is turned ON.

If the F150 is set to start in Run mode for the scene where the desired measurement conditions are registered, measurement of objects can be started by simply turning the power ON.

The default setting is for scene 0 and Monitor mode.

The following example illustrates operation when the startup scene is set to 1 and the startup mode is set to Run.

The next time the power is turned ON, the F150 will start at scene 1 and in Run mode.

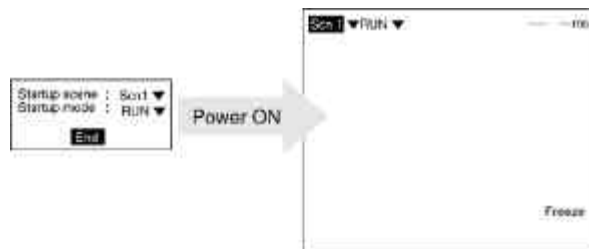

Procedure

1 Go to **SYS/Startup mode**.

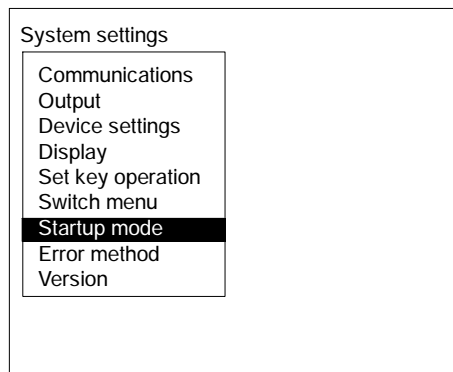

2 Select the startup scene number and the startup mode.

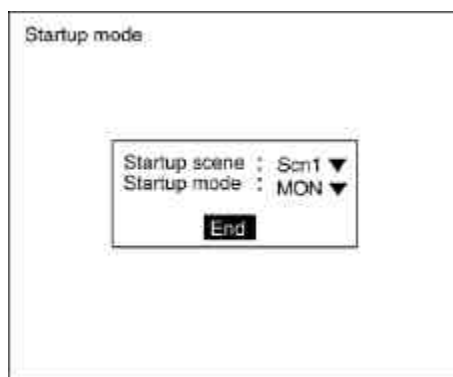

3 Select **End** to enter the settings and to exit this screen.

5-8 Selecting Output Method for Error Terminal

During processing (i.e.: while BUSY terminal is ON), even if the STEP terminal is turned ON, the F150 will not perform measurement. It is possible to set the ERR terminal so that it turns ON to indicate to an external device that input to the STEP terminal could not be received.

Selection	Details
ERR ON (default setting)	During processing (i.e.: BUSY terminal ON), if the STEP terminal turns ON, the ERR terminal will be turned ON and measurement will not be performed. The next time a STEP signal is input with the BUSY terminal OFF, the ERR terminal will go OFF.
OFF	During processing (i.e.: BUSY terminal ON), if the STEP terminal turns ON, the ERR terminal will not come ON. Measurement will not be performed.

Procedure

- 1 Go to **SYS/Error method**.

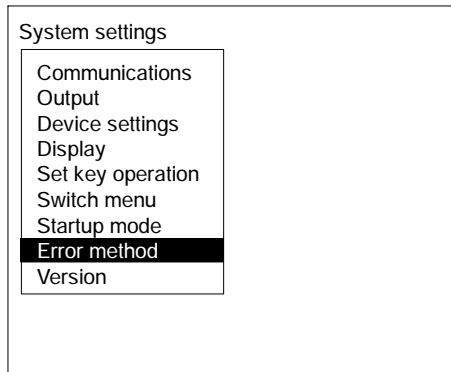

2 Select the desired setting.



3 Select **End** to enter the setting and to exit this screen.

5-9 Checking the Software Version

Use the following procedure to check the Vision Sensor model and the software system version.

Procedure

1 Go to **SYS/Version**.

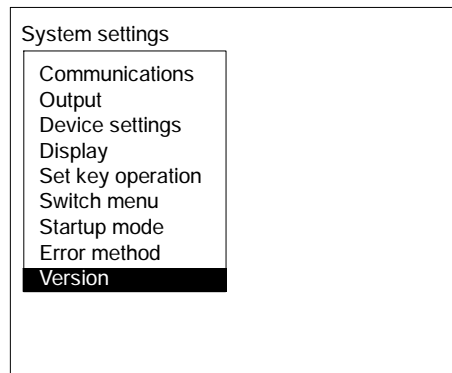

2 Select **OK** to exit this screen.

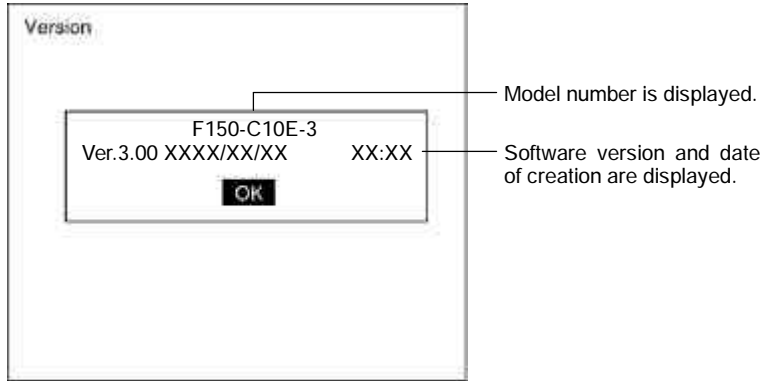

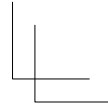
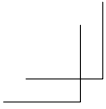

SECTION 6

Backing Up Data

This section explains how to make backup copies of data to flash memory or a computer.

When the power to the F150 is turned OFF, all data settings are cleared. The F150 loads data saved to flash memory at startup. Therefore, when settings are changed, in order not to lose these settings, be sure to save them to flash memory.

6-1	Saving/Loading System and Scene Data	178
6-2	Saving to Flash Memory	181

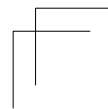
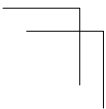

6-1 Saving/Loading System and Scene Data

The system and scene data can be backed up on a computer. The same data can also be loaded from a computer to the F150. Saving and loading data enables using the same data on other F150 Controllers.

It is recommended that data is backed up in case data is lost or the F150 malfunctions.

Data	Contents
System data	Settings under SYS .
Scene data	Settings under SET .
System data and scene data	Both the system data and scene data (0 to 15) together.
Image data	Memory images in BMP format. This is the basic image format for Windows and so the images can be displayed on a personal computer.

Note Data is saved from the F150 to a computer, and loaded to the F150 from a computer.

Caution Do not turn OFF the power or input a RESET signal while a message is being displayed in any save or load operations. Data in memory will be destroyed, and the F150 may not operate correctly the next time it is started.

Procedure

- 1 Display the Basic Screen for Monitor mode or Run mode.

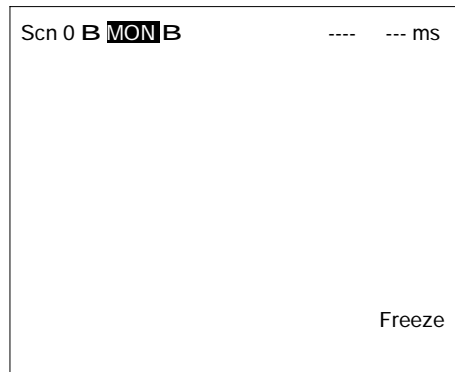

2 Move the cursor to **MON** or **RUN** and press the **ENT** Key.

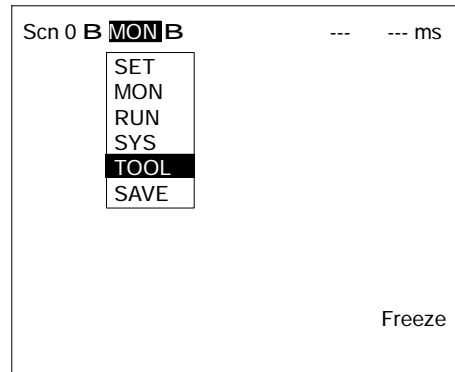

3 Select **TOOL**.

4 Select the kind of data along with the operation (load or save).

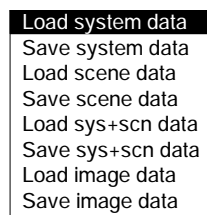

5 For scene data or image data, select the corresponding number.

Scene number (0 to 15)

Image data (Mem 0 to 23)



6 A confirmation message will be displayed. Select **Execute**.
As an example, when saving system data the following message will be displayed:

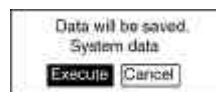

Sample Operation for Personal Computer

As an example, this section explains how to perform data transfers using HyperTerminal on Windows 95/98 or Windows NT 4.0. It is assumed that an RS-232C cable is connected to COM1 on the personal computer. If the COM number is different, adapt the procedure accordingly. If different communications software is to be used, refer to the relevant manual for that software. Data communications are performed according to Xmodem (-CRC or -SUM) protocol.

! Caution Do not turn OFF the power or input a RESET signal while a message is being displayed in any save or load operations. Data in memory will be destroyed, and the F150 may not operate correctly the next time it is started.

Saving Data to the Computer

- 1** Connect the COM 1 port on the computer and the F150 using an RS-232C cable.
- 2** Make the F150 communications settings.
The default communications settings are as shown in the following table. These settings can normally be used.

Item	Setting
Baud rate	38,400 bps
Data length	8 (bits)
Parity bits	None
Stop bits	1 (bit)
Delimiter	CR

- 3** Start the HyperTerminal program on the computer and make the following communications settings.
The same communications settings must be used on both the F150 and the modem on the computer.

Item	Setting
Speed	38,400 bps
Data bits	8 (bits)
Parity bits	None
Stop bits	1 (bit)
Flow control	None (Xmodem protocol is used.)

- 4** Execute the saving operation from the F150.
The data transfer screen will be displayed.



- 5** Select ***Transfer/Receive File*** from the HyperTerminal menu.
- 6** Specify where the file is to be saved and set the protocol to ***Xmodem***.
- 7** Select ***Receive***. The data will be transferred from the F150 to the computer.
The F150 will generate a timeout error if no response is received from the external device within 30 seconds. An error message will be displayed, and the error terminal will turn ON.

Loading Data from the Computer

- 1** Follow steps 1 to 3 in the above procedure to connect the F150 and the computer.
- 2** Select ***Transfer/Send File*** from the HyperTerminal menu.
- 3** Select the file to be sent and set the protocol to ***Xmodem***.
- 4** Select ***Send***.
The data transfer screen will be displayed.
- 5** Execute the loading operation from the F150.
The F150 will generate a timeout error if no response is received from the external device within 30 seconds. An error message will be displayed, and the error terminal will turn ON.

6-2 Saving to Flash Memory

Use the following memory to save set data to flash memory. Flash memory data is loaded each time the F150 is started up. Therefore, when settings have been changed, be sure to save to flash memory before turning the power OFF. If the power is turned OFF without saving, all of the setting changes will be lost.

Procedure

- 1 Display the Basic Screen for Monitor mode or Run mode.



- 2 Move the cursor to **MON** or **RUN** and press the **ENT** Key.

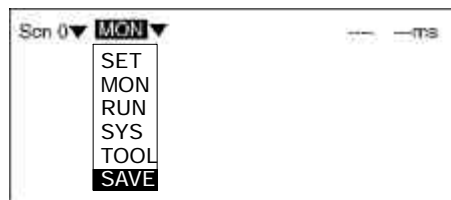

- 3 Select **SAVE**.
A confirmation message will be displayed.



- 4 Select **Execute**.
When saving has been completed, the screen for step 1 will be returned.

! Caution Do not turn OFF the power or input a RESET signal while a message is being displayed in any save or load operations. Data in memory will be destroyed, and the F150 may not operate correctly the next time it is started.



SECTION 7

Terminal Block

This section describes the communications settings and I/O formats for communications with external devices via the terminal blocks.

7-1	Communications Settings	184
7-2	I/O Formats	187
7-2-1	Inputs	187
7-2-2	Outputs	188
7-3	Terminal Signal Operation and Timing	189
7-3-1	No Handshaking	189
7-3-2	Using Handshaking (F150-C10E-3, F150-C15E-3)	193

7-1 Communications Settings

Procedures for setting communications specifications are given below. Set the F150 to the same settings as external devices.

The following communications settings are required.

Item		Description
ON state		Select whether to turn ON the OR and DO 0 to DO 15 terminals for OK or NG. The default is ON for NG.
Handshaking (F150-C10E-3, F150-C15E-3)	OFF	Used to output the measurement result without synchronizing with the external device. This is the default setting.
	ON	Used to output the measurement result while synchronizing with the external device.
Output period (Only effective without handshaking)		Set the output period for the measurement result. Set a value between 2.0 and 10,000.0 ms that is greater than the Gate ON delay + Gate ON time, and less than the measurement interval. If this period is longer than the measurement interval, the output timing will fall behind as the measurements are repeated. The default setting is 10.0 ms.
Gate ON delay		Set the time from when the result is output to the terminal block to when the GATE signal is turned ON. This time is used to wait until the data output becomes stable. Set a time between 1.0 and 1,000 ms that is longer than the delay time for the external device. The default setting is 1.0 ms.
Gate ON time (Only effective without handshaking)		Set the time for which the GATE signal is ON. Set a value between 1.0 and 1,000 ms that will allow the external device to read the measurement result. The default setting is 5.0 ms.
Timeout (F150-C10E-3, F150-C15E-3) (Only effective with handshaking)		A timeout error will occur if there is no response from the external device within the set time. Set a value between 0.5 and 120.0 s. The default setting is 10.0 s.

Procedure

- 1 Display the Basic Screen for Monitor mode or Run mode.

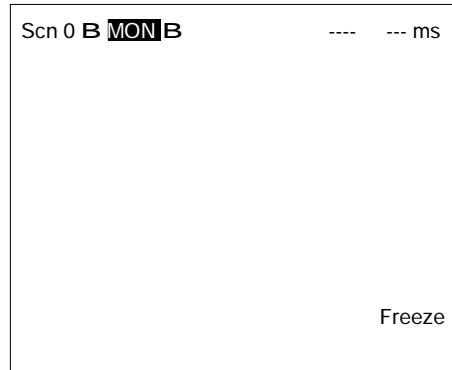

- 2 Move the cursor to **MON** or **RUN** and press the **ENT** key.

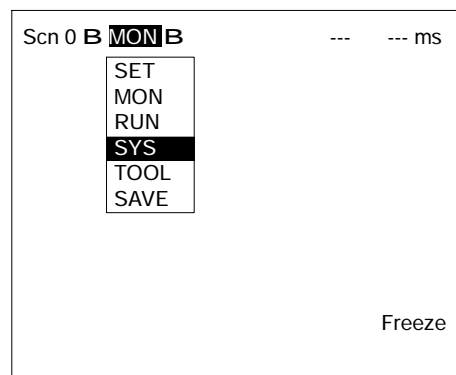

- 3 Select **SYS**.

4 Select **Communications**.

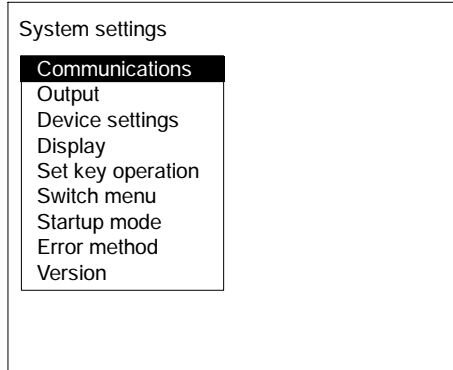

5 Select **Terminal block**.

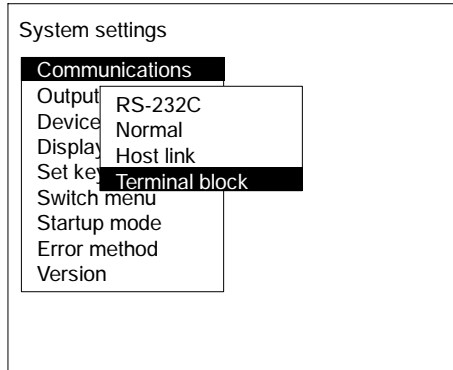

6 Set the items.

Refer to the following page for details on inputting values: → p. 26

F150-C10E-3, F150-C15E-3

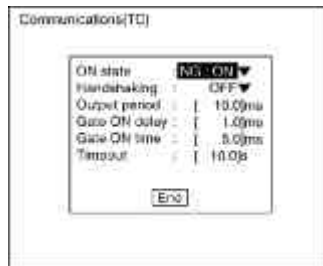

F150-C10E-3-DRT

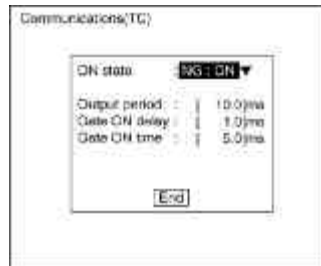

7 Select **End** to exit this screen and enter the settings.

7-2 I/O Formats

The terminal blocks can be used to input and output various signals, e.g., to input a measurement trigger from a photoelectric or other sensor and to output the overall judgement to a Programmable Controller or other external device.

7-2-1 Inputs

The following commands can be input in Monitor mode or Run mode.

STEP Terminal

One measurement will be performed when the STEP terminal turns ON.

DI0 to DI7 Terminals (F150-C10E-3, F150-C15E-3)

The following commands can be input.

To use these inputs, turn ON DI7 for 1 ms or more after setting the status of the DI0 to DI6 inputs.

The F150-C10E-3-DRT does not have any DI inputs and therefore does not support the following commands.

Command	DI inputs								Function
	Execute	Command			Operand				
	7	6	5	4	3	2	1	0	
Continuous measurement	1	0	0	1	*	*	*	*	Measurement is performed continually during command input.
Switching scenes	1	0	1	0	Scene No.				Switches the scene.
Example	1	0	1	0	0	0	1	0	Switches to scene 2.
Model registration	1	1	0	0	Region number				Re-registers the model based on the measurement image input immediately before. (This command is only valid if a region for gray search or precise search has been specified. If other regions have been specified this command will be ignored.)
Example	1	1	0	0	0	1	1	0	Registers the model for region 6.

- 0: OFF
- 1: ON
- *: Status is not read by F150, i.e., the status does not matter.

7-2-2 Outputs

Whenever a measurement is performed, the judgement is output.

The data is only output in Run mode. There is no output to the terminals in Monitor mode.

The F150 can be set to turn ON terminals for either OK or NG results. The default is for output to be ON for NG results.
→ p 182

 **Caution** After measurement is performed in Run mode, the data output to the OR terminal and DO terminal will be held until the next time measurement is performed in Run mode. The output status will be held even if the mode is changed.

 **Caution** The initial status of the output terminals is OFF. The terminals, however, may turn ON for approximately 0.5 s when the power is turned ON. Be sure to allow for this when reading the status at an external device.

OR Terminal

The overall judgement is output to the OR terminal. This overall judgement will be NG if there is one or more NG judgements for the set measurement regions or output expressions.

DO0 to DO15 Terminals (F150-C10E-3, F150-C15E-3)

Judgement Output Judgement outputs 0 to 15 set in *Expression/Judge* will be output from terminals DO0 to DO15.

Data Output If *Terminal block* is selected as the data output destination in *SYS/Output*, before judgement results are output, the results of the expressions set for data outputs 0 to 7 in *Expression/Data* will be output from the terminal blocks.

Refer to the following page for details on how to select the output destination: → p. 155

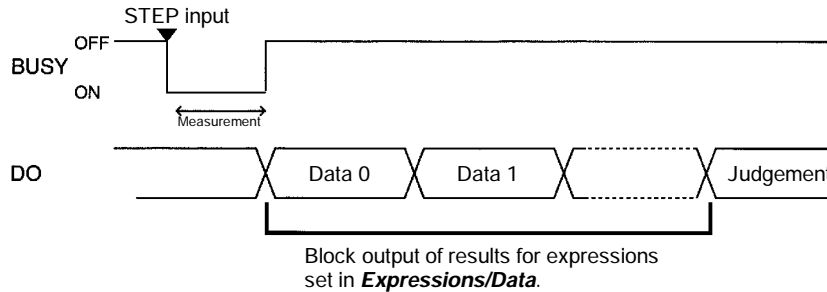

Only integral values are output. Values with digits after the decimal point are rounded to the nearest integer.

Values can be output in the range -32768 to 32767.

Values less than -32768 are output as -32768.

Values greater than 32767 are output as 32767.

Data is output in two's complement binary format.

! Caution After measurement is performed in Run mode, the data output to the OR terminal and DO terminal will be held until the next time measurement is performed in Run mode. The output status will be held even if the mode is changed.

! Caution The initial status of the output terminals is OFF. The terminals, however, may turn ON for approximately 0.5 s when the power is turned ON. Be sure to allow for this when reading the status at an external device.

7-3 Terminal Signal Operation and Timing

The following explains the operation of the terminal signals based on the various communications settings that are possible. Use the information provided here to determine which settings to make.

7-3-1 No Handshaking

The F150 outputs the measurement results without synchronization with the external device. Read the measurement results at the external device while the GATE terminal is ON.

Using the STEP Terminal as a Measurement Trigger

Judgement and Data Output Destinations Both Set to Terminal Block

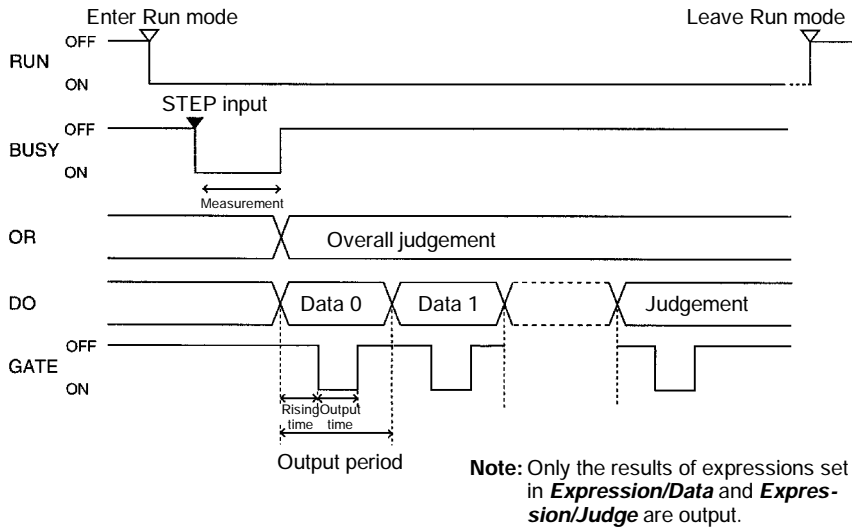

Judgement Output Destination Set to Terminal Block, Data Output Destination Set to RS-232C

Only judgement results are output via the terminal block.

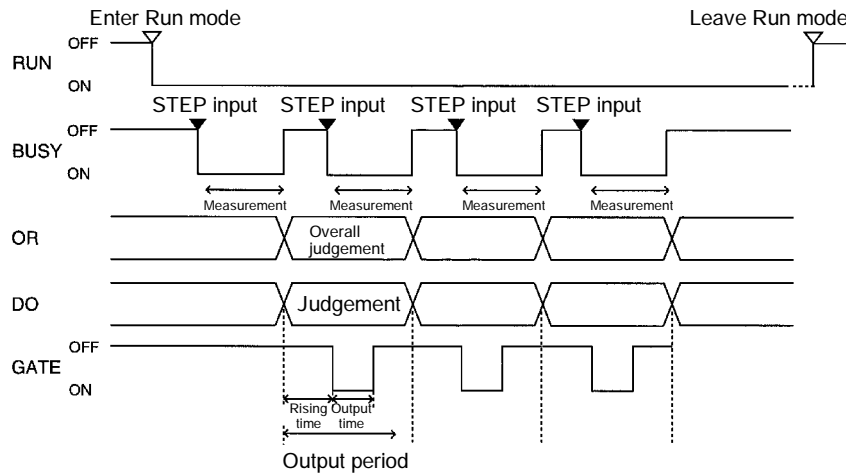

Output Terminals

Terminal	Function
RUN	Turns ON during Run mode.
BUSY	Shows that the F150 is reading an image, changing a scene, etc. Do not input the next command while the BUSY terminal is ON. Otherwise, commands may not be properly executed.
OR	Outputs the overall judgements. (Can be set to turn ON for either OK or NG judgement.) The overall result will be NG if there is one or more NG judgements for the measurement regions or output expressions.
DO	Outputs the results of the expressions set in Expression/Judge and Expression/Data and the judgement results for the output expressions. (Can be set to turn ON for either OK or NG judgement.) Note There are no DO terminals for the F150-C10E-3-DRT.
GATE	Used to time the reading of the measurement result at the external device. The time that GATE is turned ON can be set as required for the external device to correctly read the measurement result. Make the output time shorter than the duration of the measurement (STEP input). If the period is longer, the output timing will fall behind as measurements are repeated. Note If the GATE terminal control output is set to user output in the communications specifications setting menu for CompoBus/D, the GATE terminal cannot be used to control timing.

Input Terminals

Terminal	Function
STEP	Inputs a measurement trigger from a photoelectric sensor or other external device. One measurement will be taken on the rising edge of the STEP signal. Turn ON the STEP for at least 0.5 ms.

Note If a STEP signal is input while the BUSY terminal is ON, the ERR terminal will come ON. → p. 172

Performing Continuous Measurements (F150-C10E-3, F150-C15E-3)

Set the output period so that the total output time is less than the measurement time. If the total output time is more than the mea-

surement time, as measurement is repeated, the output timing will lag behind.

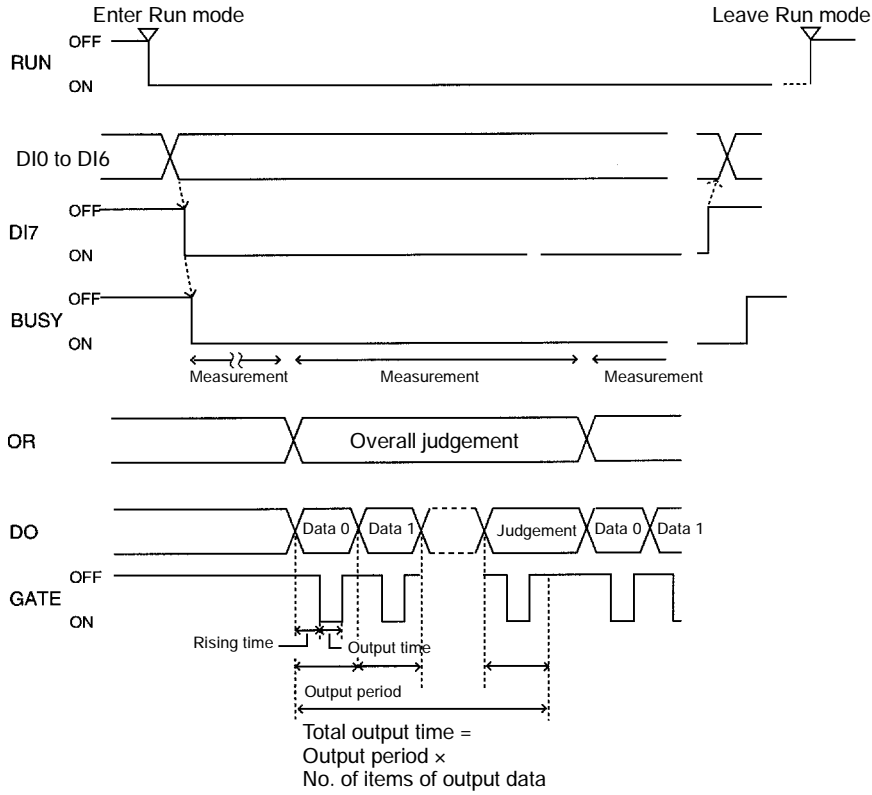

Output Terminals

The function of the output terminals is the same as when inputting a measurement trigger using the STEP terminal, as described previously.

Input Terminals

Terminal	Function
DI 0 to DI 3	OFF
DI4	ON
DI5 to DI6	OFF
DI7	Execution trigger. Leave at least 1 ms after setting DI 0 to 6 before turning DI 7 ON. During command execution, the BUSY terminal will turn ON. During execution of continuous measurement, the BUSY terminal will stay ON.

7-3-2 Using Handshaking (F150-C10E-3, F150-C15E-3)

Handshaking can be used to synchronize the F150 with an external device to output measurement results. This is an effective way to output several measurement results in order, allowing data to be properly transferred.

Using the STEP Terminal as a Measurement Trigger

Judgement and Data Output Destinations Both Set to Terminal Block

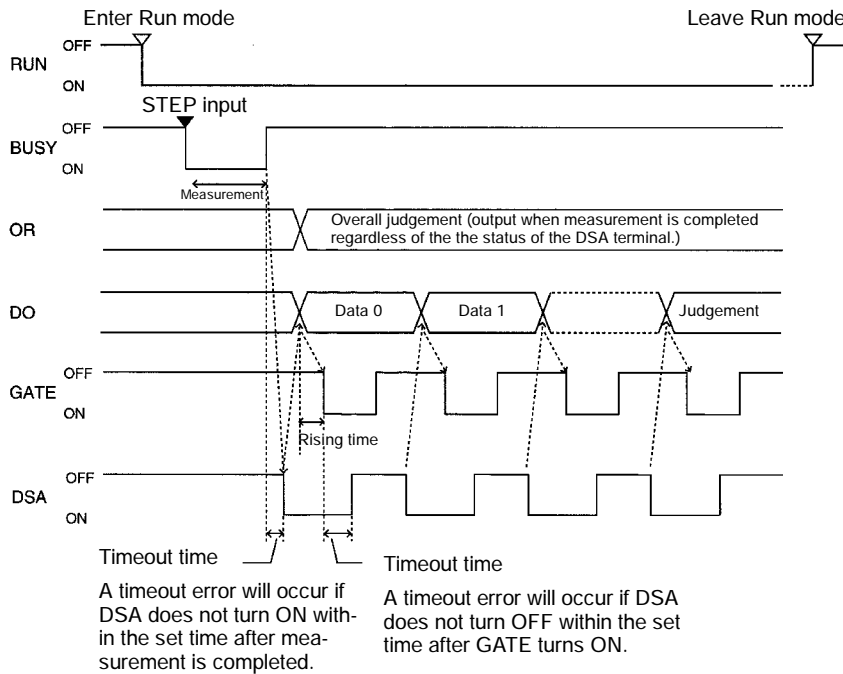

Note: Only the results of expressions set in **Expression/Data** and **Expression/Judge** are output.

The function of all terminals except the DSA terminal is the same as for communications without handshaking. The DSA terminal is only used with handshaking.

Input Terminal

Terminal	Function
DSA	<p>Requests the next data output from the external device. The F150 will not output data until this terminal is turned ON.</p> <p>Turn ON the DSA terminal when the external device is ready to receive data and the F150 has finished measurement.</p> <p>The BUSY terminal is ON during measurement, i.e., measurement will be completed when the BUSY terminal turns OFF. Use the BUSY signal to time reading measurement results.</p>

Note If a STEP signal is input while the BUSY terminal is ON, the ERR terminal will come ON. → p. 172

Scene Changing and Model Registration (F150-C10E-3, F150-C15E-3)

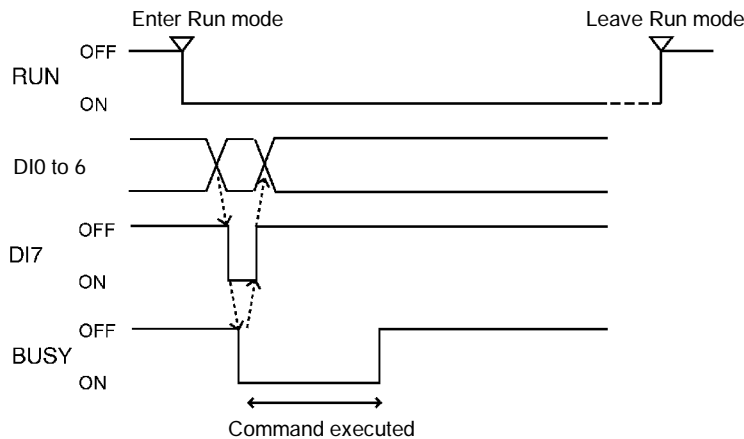

Output Terminals

Terminal	Function
RUN	Turns ON during Run mode.
BUSY	<p>Shows that the F150 is reading an image, changing a scene, etc.</p> <p>Do not input the next command while the BUSY terminal is ON. Otherwise, commands may not be properly executed.</p>

Input Terminals

Scene Changing

Terminal	Function
DI 0 to DI 3	Set the scene number (0 to 15).
DI4	OFF
DI5	ON
DI6	OFF
DI7	Execution trigger. Leave at least 1 ms after setting DI 0 to 6 before turning DI 7 ON. During command execution, the BUSY terminal will turn ON. After confirming that the BUSY terminal has turned ON, turn OFF DI 7 before turning OFF DI 0 to 6.

Model Registration

Terminal	Function
DI 0 to DI 3	Set the region number (0 to 15).
DI4	OFF
DI5	OFF
DI6	ON
DI7	Execution trigger. Leave at least 1 ms after setting DI 0 to 6 before turning DI 7 ON. During command execution, the BUSY terminal will turn ON. After confirming that the BUSY terminal has turned ON, turn OFF DI 7 before turning OFF DI 0 to 6.

SECTION 8

RS-232C Normal Settings

This section describes the communications settings for the RS-232C port when communications are set for Normal mode.

8-1	Communications Settings	198
8-1-1	Flowcharts	198
8-1-2	Communications Settings	200
8-2	Command List	205
8-3	Input Format	207
8-4	Input Commands	207
8-4-1	DATASAVE: Data Save	207
8-4-2	DISPIMG: Display Image	207
8-4-3	EXP: Expression	208
8-4-4	EXPPARA (EP): Expression Parameter	209
8-4-5	IMGLOAD: Image Load	210
8-4-6	IMGSAVE: Image Save	210
8-4-7	LITPARA: Light Parameter	211
8-4-8	MEASDATA (MD): Measure Data	213
8-4-9	MEASPARA (MP): Measure Parameter	216
8-4-10	MEASURE: Measure	221
8-4-11	MENUKEY	223
8-4-12	MODELSET: Model Set	223
8-4-13	POSIDATA (PD): Position Data	224
8-4-14	POSIPARA (PP): Position Parameter	225
8-4-15	RESET: Reset	226
8-4-16	SCENE: Scene	227
8-4-17	SCNLOAD: Scene Load	227
8-4-18	SCNSAVE: Scene Save	228
8-4-19	SYSLOAD: System Load	228
8-4-20	SYSSAVE: System Save	229
8-4-21	VERGET: Version Get	229
8-5	Measurement Results Output Format	229

8-1 Communications Settings

8-1-1 Flowcharts

If the Normal communications mode is selected, data can be output in non-procedural format to an external device via the RS-232C port.

Set Mode Command inputs cannot be received.

Monitor Mode Command inputs can be received, but measurement results are not output to external devices. Only the execution result itself (i.e.: OK or ER) is output. If a command to read a set value is input, that value will be output.

Run Mode Both command input and measurement result output are supported.

Note The output of data after measurement is performed in Run mode will continue until all of the data has been output, even if the mode is changed. Data output will not be interrupted.

Measurement Commands

I/O via RS-232C Port

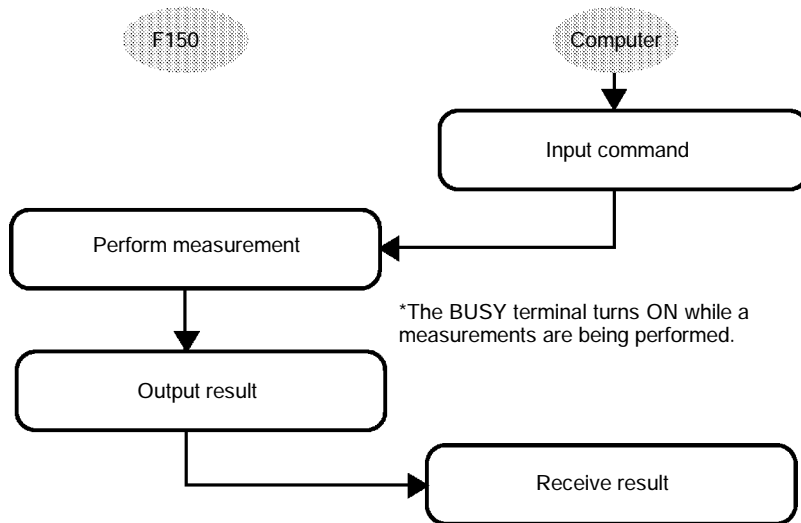

Note When RC/CS or Xon/off flow control is selected, if a response is not received from the computer within a set time, the F150 will conclude that there is a disconnection or that the computer is not operating normally, and will generate a timeout error. An error message will be displayed and the error terminal will turn ON.

Inputting Measurement Trigger from STEP Terminal

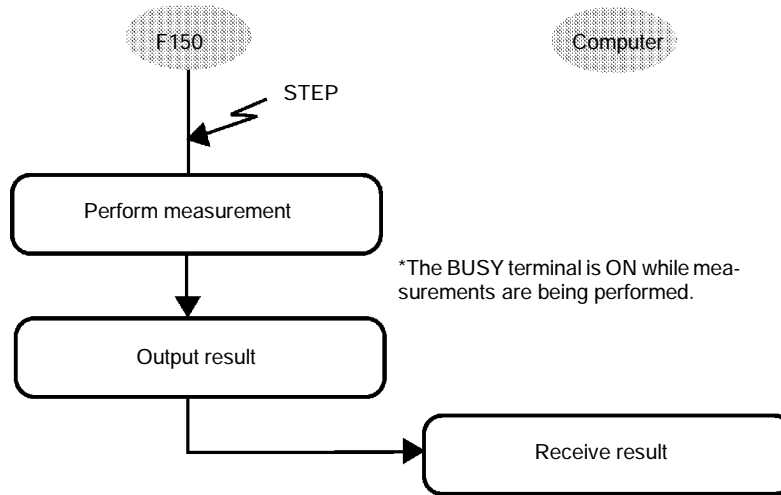

Note When RC/CS or Xon/off flow control is selected, if a response is not received from the computer within a set time, the F150 will conclude that there is a disconnection or that the computer is not operating normally, and will generate a timeout error. An error message will be displayed and the error terminal will turn ON.

Non-measurement Commands

The following timing chart shows the basic flow of command execution.

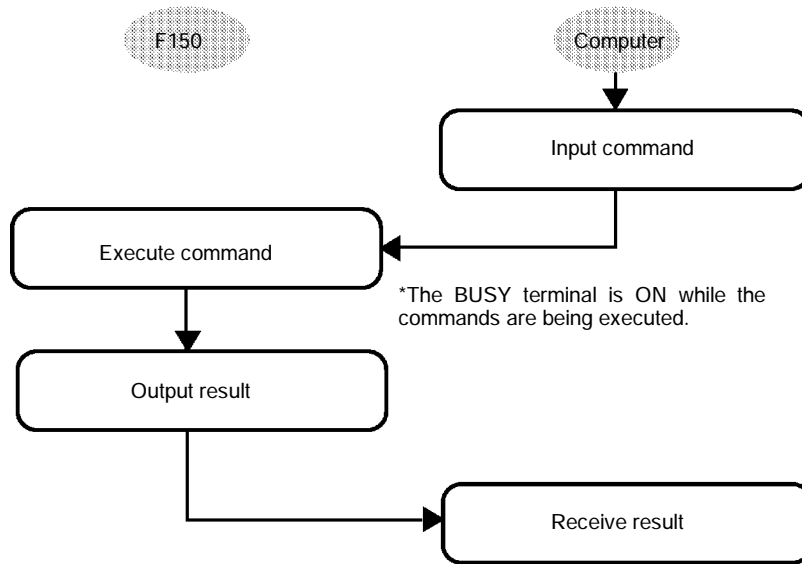

Note When RC/CS or Xon/off flow control is selected, if a response is not received from the computer within a set time, the F150 will conclude that there is a disconnection or that the computer is not operating normally, and will generate a timeout error. An error message will be displayed and the error terminal will turn ON.

8-1-2 Communications Settings

Baud Rate and Communications Mode

The following explains how to set the baud rate, data length, and other communications specifications.

The same communications settings must be used for both the F150 and the external device.

Item	Setting	
Baud rate	2,400, 4,800, 9,600, 19,200, 38,400* (bps)	Use the same settings on the IBM Programmable Controller/AT or compatible computer.
Data length	7, 8* (bits)	
Parity bits	None*, even, odd	
Stop bits	1*, 2 (bits)	
Delimiter	CR*, LF, CR+LF	
Mode	Normal*, Host Link, Menu. Select Normal.	

Note The default settings are marked with asterisks.*

Save and Load Commands

Make the following settings when using commands for save or load operations.

Item	Setting
Data length	8 bits
Parity bits	None
Stop bits	1 bit
Flow control	None

Procedure

- 1 Display the Basic Screen for Monitor mode or Run mode.

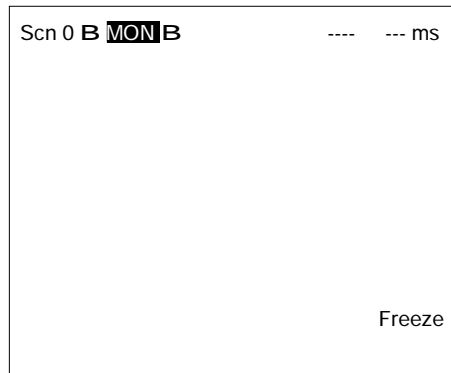

2 Move the cursor to **MON** or **RUN** and press the **ENT** Key.

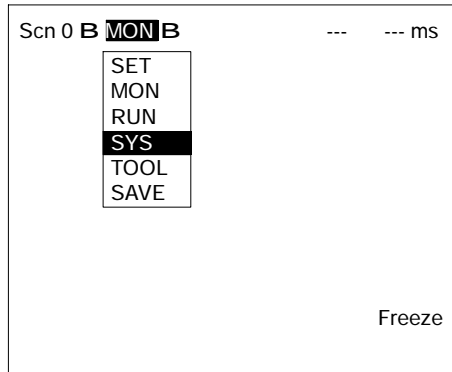

3 Select **SYS**.

4 Select **Communications**.

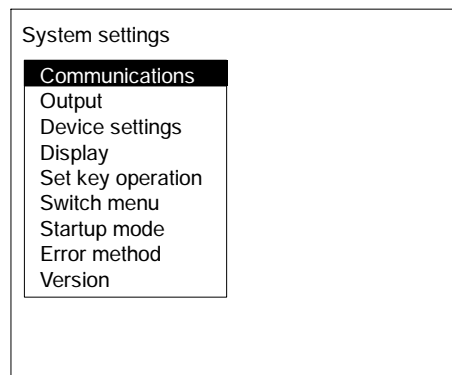

5 Select **RS-232C**.

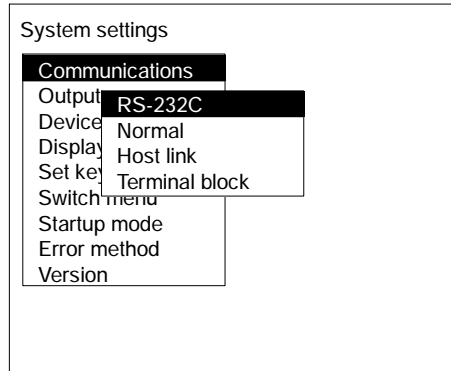

6 Set the items.

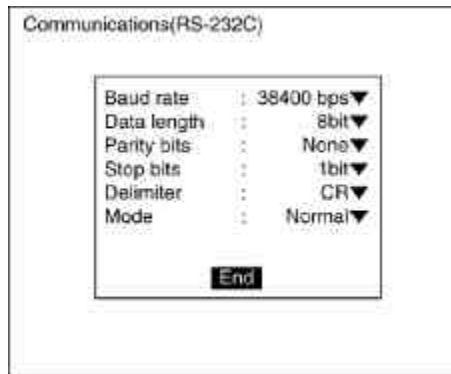

7 Select **End** to enter the settings.

Flow Control Settings

Flow control allows communications to be performed while checking the status of the external device. Timeout errors can be set to occur when there is no response from the external device after a set number of seconds.

An error message will appear on the screen if a timeout error has occurred, and the error terminal will turn ON.

Item	Setting	
Flow control	None*	No flow control.
	RS/CS	The hardware performs flow control. Use a cable that connects the RS and CS signals of the F150 and external device. Data is transferred when the CS signal from the external device is ON.
	Xon/off	The software performs flow control. Data is transferred according to the Xon/off codes from the external device.
Timeout	Set the number of seconds (1 to 120 s) before a timeout error occurs. The default is 5 s.	

Note The default settings are marked with asterisks.*

Procedure

1 Select **Normal**.

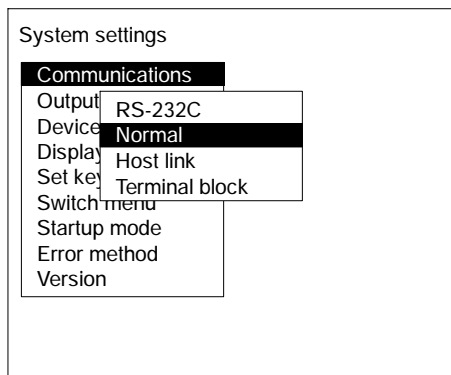

2 Set the items.

Refer to the following page for details on inputting values: → **p. 26**

3 Select **End** to enter the settings and to exit this screen.

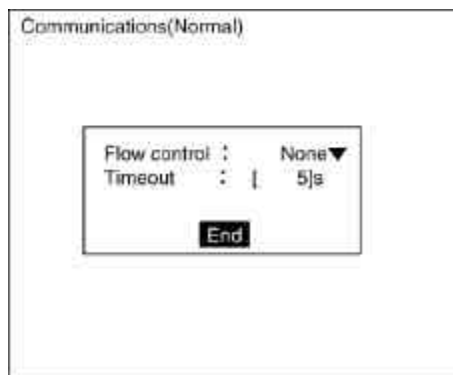

8-2 Command List

The following commands can be input from a computer or other host device connected to the RS-232C port. Commands are input in ASCII.

Ensure that the communications settings for the F150 and the external device are the same.

Commands that Control Operation

The following commands are used to control F150 operation.

Command	Function	Page
DISPIMG	Reads the memory number of the currently displayed image.	205
	Changes the displayed image.	206
MEASURE or M	Performs one measurement.	219
	Performs one measurement on the currently displayed image.	220
	Starts continuous measurement.	220
	Stops continuous measurement.	220
MENUKEY	Switches RS-232C input to menu operation.	221
MODELSET	Registers the model.	221
RESET	Resets the F150.	224
SCENE	Reads the scene number of the currently displayed scene.	225
	Changes the scene.	225

Commands that Read Measurement Results

The following commands read the results of the most recent measurement.

Command	Function	Page
POSIDATA (PD)	Reads the position compensation result or the displacement value.	222
MEASDATA (MD)	Reads the measurement result.	211
EXP	Reads the calculation result for output expressions.	206

Commands that Save/Load Data

The following commands are used to make and retrieve backup for data set at the F150.

Command	Function	Page
DATASAVE	Saves all data to flash memory.	205
SCNLOAD	Loads scene data from an external device.	225
SCNSAVE	Saves scene data to an external device.	226
SYSLOAD	Loads system data from an external device.	226
SYSSAVE	Saves system data to an external device.	227
IMGLOAD	Loads image data from an external device.	208
IMGSAVE	Saves image data to an external device.	208

Commands that Read/Change Current Settings

The following commands are used to read or change settings such as evaluation criteria. Operation can be controlled from the host by changing parameters for settings at the F150.

Command	Setting	Page
POSIPARA (PP)	Reads/sets parameters for position compensation regions.	223
MEASPARA (MP)	Reads/sets parameters for measurement regions.	214
EXPPARA (EP)	Reads/sets evaluation criteria for judgement output expressions.	207
LITPARA	Reads/sets light level of Intelligent Light Source.	209
VERGET	Reads version information for the system.	227

8-3 Input Format

The commands are input in ASCII. Commands can be made in either upper-case letters or lower-case letters.

a)
b)
c)

MEASDATA *<Measurement_region_number>* *<Parameter>* **delimit er**

- a) Variables are indicated in italics in pointed brackets< >. Actual values must be input for the variables.
- b) A space is required between each of the parameters (but not before a delimiter).
- c) A delimiter is required at the end of the command.

Note The delimiters have been omitted from the commands and responses in this manual except where required for clarity. Be sure to allow for delimiters in programming.

8-4 Input Commands

The commands are explained in alphabetical order.

8-4-1 DATASAVE: Data Save

DATASAVE is used to save all data to flash memory.

Input

DATASAVE

Output

Data correctly saved: **OK**
 Data not correctly saved: **ER**

Note Do not turn OFF the power until a response has been received.

8-4-2 DISPIMG: Display Image

DISPIMG is used to read or change the memory number of the currently displayed image.

Reading Memory Number of Currently Displayed Image

Input

DISPIMG

Output

Data correctly read: *<Memory_number>*
OK
 Command not correct: **ER**

When a through or freeze image is being displayed, the memory number for the latest measurement image is output. If there is no measurement image stored in memory, -1 will be output.

Example

Input: DISPIMG
Output: 12
OK

The memory image number 12 is being displayed.

Changing Currently Displayed Image

Input

DISPIMG <Memory_number>

- Specify a memory number in the range -1 to 23. If -1 is specified, the display will change to a through or freeze image, depending on the display settings. → p. 158

Output

Command correctly executed: **OK**
 Command not correct: **ER**

Example

Input: DISPIMG 8
 Memory image number 8 is displayed.
Output: OK

8-4-3 EXP: Expression

EXP is used to read the results of output expressions.

Input

EXP <Output_type> <Output_number>

- Specify the following values for output type and output number:

Item	Output type	Output number
Judgement	0	0 to 15
Data	1	0 to 7

Output

Data correctly read: <Measurement_result>
OK
 Command not correct: **ER**

Example

Input: EXP 1 0

The measurement result of the output expression for data 0 is read.

**Output: 28.195
OK**

The measurement value is 28.195.

8-4-4 EXPPARA (EP): Expression Parameter

EXPPARA can be used to read or set evaluation criteria for judgement output expressions.

Reading Evaluation Criteria for Judgement Output Expressions

Input

EXPPARA <Judgement_number> <Parameter>

or

EP <Judgement_number> <Parameter>

- Specify a judgment number in the range 0 to 15.
- The contents of the parameters are as follows:

Parameter	Contents
0	Upper limit
1	Lower limit

Output

Data correctly read: <Evaluation_criteria>
OK

Command not correct: **ER**

Example

Input: EXPPARA 0 0

The upper limit for judgement 0 is read.

**Output: 100.000
OK**

The upper limit is 100.000.

Setting Evaluation Criteria for Judgement Output Expressions

Input

EXPPARA <Judgement_number> <Parameter>
<Value>

or

EP <Judgement_number> <Parameter> <Value>

- Specify a judgement number in the range 0 to 15.
- The contents and setting range for the parameters are as follows:

Parameter	Contents
0	Upper-limit value (-9,999,999.999 to 9,999,999.999)
1	Lower-limit value (-9,999,999.999 to 9,999,999.999)

Output

Correct settings made: **OK**
 Correct settings not made: **ER**

Example

Input: EXPPARA 0 0 150.000

The upper limit for judgement 0 is changed to 150.000.

Output: OK

8-4-5 IMGLOAD: Image Load

IMGLOAD is used to load image data from an external device.

Input

IMGLOAD <Memory_image_number>

- Specify a memory image number in the range 0 to 23. The image data is loaded with Xmodem (-CRC or -SUM) protocol.
- When preparations to receive the data are completed, the F150 will send a READY signal to the external device. Send the data from the external device when the READY signal has been received.
- Only image data that has been saved from an F150 can be loaded.

Output

Data correctly loaded: **OK**
 Data not correctly loaded: **ER**

Example

Input: IMGLOAD 2

Image data is loaded from the external device to memory image 2.

Output: OK

8-4-6 IMGSAVE: Image Save

IMGSAVE is used to save image data to an external device.

Input

IMGSAVE <Memory_image_number>

- Specify a memory image number in the range 0 to 23. The image data is saved with Xmodem (-CRC or -SUM) protocol.
- The memory image is transferred in BMP format.

Output

Data correctly saved: **OK**
 Data not correctly saved: **ER**

Example

Input: IMGSAVE 2

The data in memory image 2 is saved to the external device.

Output: OK

8-4-7 LITPARA: Light Parameter

LITPARA is used to read or change the light level of the Intelligent Light Source.

Reading Light Level of Intelligent Light Source

Input

LITPARA <Camera_number>

Specify either 0 or 1 as the Camera number. If the 2-Camera Unit is not used, specify 0.

Output

The light level is output as either a 5 or 8-digit number. Each digit represents the level for one illuminated region in the range 0 to 7 (0 = not lit).

- F150-LTC20

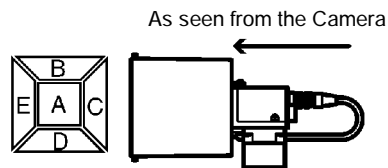
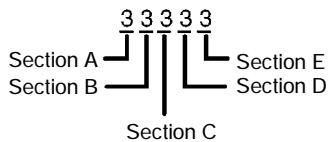

- F150-LTC50

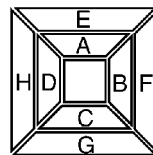
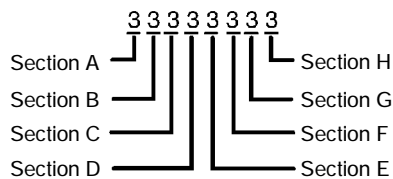

Data correctly read: <Light_level>
OK
Command not correct: ER

Example

Input: LITPARA 0

The light level for the Intelligent Light Source (F150-LTC20) connected to Camera 0 is read.

Output: 05555
OK

The distribution of light level is as shown below.

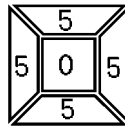

Changing Light Level of Intelligent Light Source

Input

LITPARA <Camera_number> <Light_level>

- Specify either 0 or 1 as the Camera number. If the 2-Camera Unit is not used, specify 0.
- Depending on the model used, set either a 5 or 8-digit figure as the light level. Refer to the graphics given in *Reading Light Level of Intelligent Light Source* for details of the correspondence between digits and sections. Set a value between 0 and 7 for each digit. "0" represents the unlit state; the higher the number the higher the light level.

Output

Data correctly set: OK
Command not correct: ER

Example

Input: LITPARA 0 77777

The light level for the Intelligent Light Source (F150-LTC20) connected to Camera 0 will be set in the way shown below.

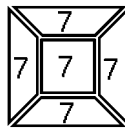

Output: OK

8-4-8 MEASDATA (MD): Measure Data

MEASDATA is used to read measurement results.

Input

MEASDATA <Region_number> <Parameter>

or

MD <Region_number> <Parameter>

- Specify a region number in the range 0 to 15.
- The meaning of the parameter will vary according to the measurement method set for the region number specified. Refer to the parameter lists following.

Output

Data correctly read: <Measurement_result>

OK

Command not correct: **ER**

Example

Input: MD 0 2

Y coordinate measurement result for region 0 (gray search) is read.

Output: 200.000

OK

The Y coordinate measurement value is 200.000.

Lists of Parameters (Common to MEASDATA/POSIDATA)**Binary Center of Gravity and Area, Binary Center of Gravity and Axis Angle**

Parameter	Meaning
0	Judgement result (0: OK, -1: NG, -2: no measurement)
1	X coordinate of measured center of gravity
2	Y coordinate of measured center of gravity
3	X coordinate of reference center of gravity
4	Y coordinate of reference center of gravity
5	Displacement in X direction (measured X coordinate of center of gravity - reference X coordinate of center of gravity)
6	Displacement in Y direction (measured Y coordinate of center of gravity - reference Y coordinate of center of gravity)
7	Measured value for area
8	Reference value for area
9	Measured value for area - reference value for area
10	Inverted area (area of measurement region - measured area)
11	Measured axis angle
12	Reference axis angle
13	Axis displacement (measured axis angle - reference axis angle)

Note Parameters 11 to 13 are only used when the measurement method is binary center of gravity and axis angle.

Edge Pitch (MEASDATA Command Only)

Parameter	Meaning
0	Judgement result (0: OK, -1: NG, -2: no measurement)
1	Number of detected objects
2	Average pitch
3	Maximum pitch
4	Minimum pitch
5	Average width
6	Maximum width
7	Minimum width

Gray Search, Precise Search

Parameter	Meaning
0	Judgement result (0: OK, -1: NG, -2: no measurement)
1	Measured X coordinate
2	Measured Y coordinate
3	Reference X coordinate
4	Reference Y coordinate
5	Displacement in X direction (measured X coordinate - reference X coordinate)
6	Displacement in Y direction (measured Y coordinate - reference Y coordinate)
7	Correlation value

Gray Edge Position

Parameter	Meaning
0	Judgement result (0: OK, -1: NG, -2: no measurement)
1	Measured edge coordinate
2	Reference edge coordinate
3	Displacement (measured coordinate - reference coordinate)

Surface Defect (MEASDATA Command Only)

Parameter	Meaning
0	Judgement result (0: OK, -1: NG, -2: no measurement)
1	Measured defect
2	Maximum density value
3	Minimum density value

Density Averaging (MEASDATA Command Only)

Parameter	Meaning
0	Judgement result (0: OK, -1: NG, -2: no measurement)
1	Measured average density
2	Reference average density
3	Difference between measured average density and reference average density

Relative Search (MEASDATA Command Only)

Parameter	Meaning
0	Judgement result (0: OK, -1: NG, -2: no measurement)
1	Measured X width
2	Measured Y width
3	Measured distance
4	Reference X width
5	Reference Y width
6	Reference distance
7	Difference in X widths (measured width - reference width)
8	Difference in Y widths (measured width - reference width)
9	Difference in distances (measured distance - reference distance)
10	Correlation with model 0
11	Correlation with model 1

8-4-9 MEASPARA (MP): Measure Parameter

MEASPARA can be used to read or set parameters for measurement regions.

Reading Measurement Region Parameters

Input

MEASPARA <Region_number> <Parameter>

or

MP <Region_number> <Parameter>

- Specify a region number in the range 0 to 15.
- The meaning of the parameter will vary according to the measurement method set for the region number specified. Refer to the parameter lists following.

Output

Parameter correctly read: <Value>
OK

Command not correct: **ER**

Example

Input: MP 0 1

Lower limit for X coordinate for region 0 (gray search) is read.

**Output: 200.000
OK**

The parameter is set to 200.000.

Setting Measurement Region Parameters

Input

MEASPARA <Region_number> <Parameter> <Value>

or

MP <Region_number> <Parameter> <Value>

- Specify a region number in the range 0 to 15.
- The meaning of the parameter and the possible values will vary according to the measurement method set for the region number specified. Refer to the parameter lists following.

Output

Parameter correctly set: **OK**

Parameter not correctly set: **ER**

Example

Input: MP 0 1 400.000

Lower limit for X coordinate for region 0 (gray search) is set to 400.000.

Output: OK

Lists of Parameters (Common to MEASPARA/POSIPARA)**Binary Center of Gravity and Area, Binary Center of Gravity and Axis Angle**

Parameter	Meaning
0	Upper limit of X coordinate of center of gravity (-9,999.999 to 9,999.999)
1	Lower limit of X coordinate of center of gravity (-9,999.999 to 9,999.999)
2	Upper limit of Y coordinate of center of gravity (-9,999.999 to 9,999.999)
3	Lower limit of Y coordinate of center of gravity (-9,999.999 to 9,999.999)
4	Upper limit of area (0 to 9,999,999.999)
5	Lower limit of area (0 to 9,999,999.999)
6	Upper-left X coordinate of region (0 to 511)
7	Upper-left Y coordinate of region (0 to 483)
8	Lower-right X coordinate of region (0 to 511)
9	Lower-right Y coordinate of region (0 to 483)
10	Upper limit of binary level (0 to 255)
11	Lower limit of binary level (0 to 255)
12	Binary level inversion (0: not inverted, 1: inverted)
13	Upper limit of axis angle (-180.000 to 180.000)
14	Lower limit of axis angle (-180.000 to 180.000)

Note Parameters 13 and 14 are only used when measurement method is binary center of gravity and axis angle.

Gray Edge Position

Parameter	Meaning
0	Upper limit of position (-9,999.999 to 9,999.999)
1	Lower limit of position (-9,999.999 to 9,999.999)
2	Upper-left X coordinate of region (0 to 511)
3	Upper-left Y coordinate of region (0 to 483)
4	Lower-right X coordinate of region (0 to 511)
5	Lower-right Y coordinate of region (0 to 483)
6	Edge search direction (↑: 0, ↓: 1, →: 2, ←: 3)
7	Edge color (Light → Dark: 0, Dark → Light: 1)
8	Level (0 to 100)

Gray Search, Precise Search

Parameter	Meaning
0	Upper limit of X coordinate (-9,999.999 to 9,999.999)
1	Lower limit of X coordinate (-9,999.999 to 9,999.999)
2	Upper limit of Y coordinate (-9,999.999 to 9,999.999)
3	Lower limit of Y coordinate (-9,999.999 to 9,999.999)
4	Upper limit of correlation value (0 to 100)
5	Lower limit of correlation value (0 to 100)
6	Upper-left X coordinate of search region (0 to 511)
7	Upper-left Y coordinate of search region (0 to 483)
8	Lower-right X coordinate of search region (0 to 511)
9	Lower-right Y coordinate of search region (0 to 483)
10	X coordinate of reference position (0 to 511)
11	Y coordinate of reference position (0 to 483)
12	Search speed (0: LOW → 1 → 2 → 3 → 4: HIGH)

Edge Pitch (MEASPARA Command Only)

Parameter	Meaning
0	Upper limit of number of objects (0 to 255)
1	Lower limit of number of objects (0 to 255)
2	Upper limit of pitch (0 to 9,999.999)
3	Lower limit of pitch (0 to 9,999.999)
4	Upper limit of width (0 to 9,999.999)
5	Lower limit of width (0 to 9,999.999)
6	Upper-left X coordinate of region (0 to 511)
7	Upper-left Y coordinate of region (0 to 483)
8	Lower-right X coordinate of region (0 to 511)
9	Lower-right Y coordinate of region (0 to 483)
10	Counted object color (White: 0, Black: 1)
11	Edge level (0 to 100)
12	Minimum level (0 to 255)

Surface Defect (MEASPARA Command Only)

Parameter	Meaning
0	Defect (0 to 255)
1	Upper limit of density value (0 to 255)
2	Lower limit of density value (0 to 255)
3	Element size (4 to 80)
4	Compare pitch (1 to 6)
5 to 10	See note

Note The meaning of parameters 5 to 10 varies according to the shape of the region.

Parameter	Box	Line	Circumference	Arc
5	Upper-left X coordinate of region (0 to 511)	X coordinate of start point (0 to 511)	X coordinate of center (0 to 511)	X coordinate of center (0 to 511)
6	Upper-left Y coordinate of region (0 to 483)	Y coordinate of start point (0 to 483)	Y coordinate of center (0 to 483)	Y coordinate of center (0 to 483)
7	Lower-right X coordinate of region (0 to 511)	X coordinate of end point (0 to 511)	Radius (1 to 512)	Radius (1 to 512)
8	Lower-right Y coordinate of region (0 to 483)	Y coordinate of end point (0 to 483)	Width (1 to 64)	Width (1 to 64)
9	---	Width (1 to 64)	---	Start angle (-180.00 to 180.00)
10	---	---	---	End angle (-180.00 to 180.00)

Density Averaging (MEASPARA Command Only)

Parameter	Meaning
0	Upper limit of average density (0.000 to 255.000)
1	Lower limit of average density (0.000 to 255.000)
2	Upper-left X coordinate of region (0 to 511)
3	Upper-left Y coordinate of region (0 to 483)
4	Lower-right X coordinate of region (0 to 511)
5	Lower-right Y coordinate of region (0 to 483)

Relative Search (MEASPARA Command Only)

Parameter	Meaning
0	Upper limit of width X (-9999.999 to 9999.999)
1	Lower limit of width X (-9999.999 to 9999.999)
2	Upper limit of width Y (-9999.999 to 9999.999)
3	Lower limit of width Y (-9999.999 to 9999.999)
4	Upper limit of distance (0 to 9999.999)
5	Lower limit of distance (0 to 9999.999)
6	Upper limit of correlation with model 0 (0 to 100)
7	Lower limit of correlation with model 0 (0 to 100)
8	Upper limit of correlation with model 1 (0 to 100)
9	Lower limit of correlation with model 1 (0 to 100)
10	Upper-left X coordinate of search region for model 0 (0 to 511)
11	Upper-left Y coordinate of search region for model 0 (0 to 483)
12	Lower-right X coordinate of search region for model 0 (0 to 511)
13	Lower-right Y coordinate of search region for model 0 (0 to 483)
14	Upper-left X coordinate of search region for model 1 (0 to 511)
15	Upper-left Y coordinate of search region for model 1 (0 to 483)
16	Lower-right X coordinate of search region for model 1 (0 to 511)
17	Lower-right Y coordinate of search region for model 1 (0 to 483)
18	X coordinate of reference position for model 0 (0 to 511)
19	Y coordinate of reference position for model 0 (0 to 483)
20	X coordinate of reference position for model 1 (0 to 511)
21	Y coordinate of reference position for model 1 (0 to 483)
22	Search speed (0: LOW → 1 → 2 → 3 → 4: HIGH)

8-4-10 MEASURE: Measure

MEASURE is used to perform measurements one at a time or to stop and start continuous measurements.

Performing One Measurement

Input

MEASURE
or
M

Output

Measurement correctly performed:
 <Measurement_results> → p 227
 OK
Measurement not correctly performed: **ER**

Executing One Measurement on Currently Displayed Image

MEASURE /I
or
M /I

Output

Measurement correctly performed:
 <Measurement_results> → p 227
 OK
Measurement not correctly performed: **ER**

Starting Continuous Measurements

Input

MEASURE /C
or
M /C

Output

Measurement correctly performed:
 OK delimiter <Continuous_measurement_results>
 → p 227
Measurement not correctly performed: **ER**

Stopping Continuous Measurements

Input

MEASURE /E
or
M /E

Output

Measurement correctly stopped: **OK**

Measurement not correctly stopped: **ER**

8-4-11 MENUKEY

MENUKEY is used to switch RS-232C input to Menu operation mode.

Input

MENUKEY

Output

Nothing is output for this command.

Return to Normal mode from Menu operation mode by inputting **CTRL + Q(\$11)**.

8-4-12 MODELSET: Model Set

MODELSET is used to re-register the model based on the currently displayed image.

Input

MODELSET <Region_number>

- Specify a region number in the range 0 to 15. This command is only valid for regions where the measurement method is gray search or precise search.

Output

Model correctly registered: **OK**

Model not correctly registered: **ER**

Example

Input: MODELSET 2

The model for region 2 (gray search) is registered.

Output: OK

If a region for which the measurement method is not gray search or precise search is specified, the command will be ignored but an OK will be output.

Example

If region 1, for which the measurement method is set to binary center of gravity and area, is specified:

Input: MODELSET 1

Output: OK

No settings are made.

Two-camera Operation

If the camera mode is Two-camera Switching mode, since MODELSET registers the image currently displayed, display the

region for the desired Camera before execution. Use the **Up/Down** Console Keys to switch Camera images. By executing the MENUKEY command, Camera images can be switched from a personal computer using the key codes equivalent to the **Up/Down** Console keys.

8-4-13 POSIDATA (PD): Position Data

POSIDATA is used to read position compensation results or position displacements.

Reading Position Compensation Result

Input

POSIDATA

<Position_Compensation_Region_Number>
<Parameter>

- Specify a position compensation region number of 0 or 1.

Two-camera Operation

If two Cameras are used, specify 0 or 1 (for **Position compensation 0**), or 10 or 11 (for **Position compensation 1**).

- The meaning of the parameter will vary according to the position compensation method for the specified region. The parameters are the same as for MEASDATA. Refer to the MEASDATA parameter lists given previously in this section.

Output

Data correctly read: <Position_compensation_result>
 OK
Command not correct: **ER**

Example

Input: POSIDATA 0 2

Y coordinate measurement value for position compensation region 0 (gray search) is read.

Output: 200.000
 OK

Y coordinate measurement value is 200.000.

Reading Displacement Value

Input

POSIDATA <Parameter 1> <Parameter 2>

- Specify 2 for parameter 1.

Two-camera Operation

If two Cameras are used, specify 2 (for **Position compensation 0**) or 12 (for **Position compensation 1**) for parameter 1.

- The meanings of parameter 2 settings are as follows:

Parameter	Meaning
0	Displacement in X direction (reference X coordinate - measured X coordinate)
1	Displacement in Y direction (reference Y coordinate - measured Y coordinate)
2	Angle displacement (reference angle - measured angle)

Output

Data correctly read: <Position_displacement>

OK

Command not correct:

ER

Example

Input: POSIDATA 2 0

Position displacement in the X direction is read.

Output: 95.65

OK

Displacement in the X direction is 95.65.

8-4-14 POSIPARA (PP): Position Parameter

POSIPARA is used to read or set position compensation region parameters.

Reading Position Compensation Region Parameters**Input**

POSIPARA <Position_compensation_region_number>
<Parameter>

or

PP <Position_compensation_region_number>
<Parameter>

- Select a position compensation region number of 0 or 1.

**Two-camera
Operation**

If two Cameras are used, specify 0 or 1 (for *Position compensation 0*), or 10 or 11 (for *Position compensation 1*).

- The meaning of the parameter will vary according to the position compensation method for the specified region. The parameters are the same as for MEASPARA. Refer to the MEASPARA parameter lists given previously in this section.

Output

Parameter correctly read: <Value>

OK

Command not correct: **ER**

Example

Input: PP 0 1

Lower limit of the X coordinate for position compensation region 0 (gray search) is read.

**Output: 200.000
OK**

Lower limit of the X coordinate is set to 200.000.

Setting Position Compensation Region Parameters

Input

POSI PARA <Position_compensation_region_number>
<Parameter> <Value>

or

PP <Position_compensation_region_number>
<Parameter> <Value>

- Select a position compensation region number of 0 or 1.

Two-camera Operation

If two Cameras are used, specify 0 or 1 (for **Position compensation 0**), or 10 or 11 (for **Position compensation 1**).

- The meaning of the parameter will vary according to the position compensation method for the specified region. The parameters are the same as for MEASPARA. Refer to the MEASPARA parameter lists given previously in this section.

Output

Parameter correctly set: **OK**

Parameter not correctly set: **ER**

Example

Input: PP 0 1 400

Lower limit of the X coordinate for position compensation region 0 (gray search) is changed to 400.000.

Output: OK

8-4-15 RESET: Reset

RESET is used to reset the F150.

Input

RESET

Output

Nothing is output for this command.

8-4-16 SCENE: Scene

SCENE is used to read the currently displayed scene number or switch scene.

Reading the Scene Number

Input

SCENE

Output

Data correctly read: <Scene_number>
 OK
Command not correct: **ER**

Example

Input: SCENE
Output: 0
 OK
 Scene 0 is displayed.

Switching the Scene

Input

SCENE <Scene_number>
• Specify a scene number in the range 0 to 15.

Output

Scene correctly switched: **OK**
Scene not correctly switched: **ER**

Example

Input: SCENE 2
 The measurement scene is changed to scene 2.
Output: OK

8-4-17 SCNLOAD: Scene Load

SCNLOAD is used to load scene data from a computer or other external device.

Input

SCNLOAD <Scene_number>
• Specify a scene number in the range 0 to 15. The scene data is transferred with Xmodem (-CRC or -SUM) protocol.
• When preparations to receive the data are completed, the F150 will send a READY signal to the external device. Send

the data from the external device when the READY signal has been received.

Output

Data correctly loaded: **OK**
Data not correctly loaded: **ER**

Example

Input: **SCNLOAD 2**

Data is loaded to scene 2 from an external device.

Output: **OK**

8-4-18 SCNSAVE: Scene Save

SCNSAVE is used to save scene data to a computer or other external device.

Input

SCNSAVE <Scene_number>

- Specify a scene number in the range 0 to 15. The scene data is transferred with Xmodem (-CRC or -SUM) protocol.

Output

Data correctly saved: **OK**
Data not correctly saved: **ER**

Example

Input: **SCNSAVE 2**

Data from scene 2 is saved to an external device.

Output: **OK**

8-4-19 SYSLOAD: System Load

SYSLOAD is used to load system data from a computer or other external device.

Input

SYSLOAD

- When preparations to receive the data are completed, the F150 will send a READY signal to the external device. Send the data from the external device when the READY signal has been received.

Output

Data correctly loaded: **OK**
Data not correctly loaded: **ER**

Example

Input: **SYSLOAD**

System data is loaded from an external device.

Output: OK

8-4-20 SYSSAVE: System Save

SYSSAVE is used to save system data to a computer or other external device.

Input

SYSSAVE

Output

Data correctly saved: **OK**

Data not correctly saved: **ER**

Example

Input: SYSSAVE

System data is saved to an external device.

Output: OK

8-4-21 VERGET: Version Get

VERGET is used to read information about the system version.

Input

VERGET

Output

Data correctly read: *<Version_information>*

OK

Data not correctly read: **ER**

Example

Input: VERGET

Version information is read.

Output: F150-C10E-3 Ver3.00 XXXX/XX/XX

XX:XX

OK

8-5 Measurement Results Output Format

Measurement results are output in ASCII in order from the smallest output number to the largest.

The measurement results are output in the normal format even in Menu operation mode.

The amount of output data will depend on the number of digits in the measurement values.

[<Measurement_results_for_data_0>],
[<Measurement_results_for_data_1>],
[<Measurement_results_for_data_2>],
[<Measurement_results_for_data_3>],
[<Measurement_results_for_data_4>],
[<Measurement_results_for_data_5>],
[<Measurement_results_for_data_6>],
[<Measurement_results_for_data_7>]

- Outputs are made in decimal, with a maximum of 7 digits before the decimal point and 3 digits after. The number of digits before the decimal point that are actually displayed will vary according to the measurement value but the number of digits after the decimal point is fixed to 3.
- Calibrated values are output. Output values will be in the range -9,999,999.999 to 9,999,999.999. If the measurement value is less than -9,999,999.999, then -9,999,999.999 will be output. If the measurement value is greater than 9,999,999.999, then 9,999,999.999 will be output.
- When a judgement is set, either 0 (OK) or -1 (NG) will be output.

Note The output of data after measurement is performed in Run mode will continue until all of the data has been output, even if the mode is changed. Data output will not be interrupted.

SECTION 9

RS-232C Host Link Settings

This section describes the communications settings for the RS-232C port when communications are in Host Link mode.

Communications in Host Link mode are only supported for the F150-C10E-3 and F150-C15E-3.

9-1	Communications Settings	232
9-1-1	FlowCharts	232
9-1-2	Communications Settings	236
9-2	Command Tables	241
9-3	Input Format	242
9-3-1	0010: ONE MEASUREMENT	242
9-3-2	0011: CONTINUOUS MEASUREMENT	243
9-3-3	0012: STOP MEASUREMENT	243
9-3-4	0020: SWITCH SCENE	243
9-3-5	0021: INCREMENT SCENE	243
9-3-6	0022: DECREMENT SCENE	243
9-3-7	0023: READ SCENE NUMBER	244
9-3-8	0040: MODEL REGISTER	244
9-3-9	0066: SAVE DATA	244
9-3-10	0092: RESET	245
9-3-11	0080: READ MEASUREMENT	245
9-3-12	1060: SET PARAMETER	248
9-3-13	1070: READ PARAMETER	253
9-3-14	1100: SET JUDGEMENT OUTPUT EXPRESSION CRITERIA	254
9-3-15	1110: READ JUDGEMENT OUTPUT EXPRESSION CRITERIA	255
9-3-16	1120: SET LIGHT LEVEL	256
9-3-17	1130: READ LIGHT LEVEL	256
9-3-18	1210: READ POSITION	257
9-3-19	1220: READ JUDGEMENT OUTPUT EXPRESSION RESULT	260
9-3-20	1221: READ DATA OUTPUT EXPRESSION RESULT	261
9-4	Output Format	262
9-5	Sample Ladder Program	265

9-1 Communications Settings

9-1-1 FlowCharts

Select Host Link for the communications mode to communicate in Host Link format with a Programmable Controller or other host device via the RS-232C port.

Set Mode Command inputs cannot be received.

Monitor Mode Command inputs can be received, but measurement results are not output to external devices. If a command to read a set value is input, that value will be output.

Run Mode Both command input and measurement result output are supported.

Note The output of data after measurement is performed in Run mode, will continue until all of the data has been output, even if the mode is changed. Data output will not be interrupted.

I/O via RS-232C Port

Commands for the F150 are written to the Read Area in the Programmable Controller. The F150 will automatically read these commands, execute them, and write any results to the Write Area.

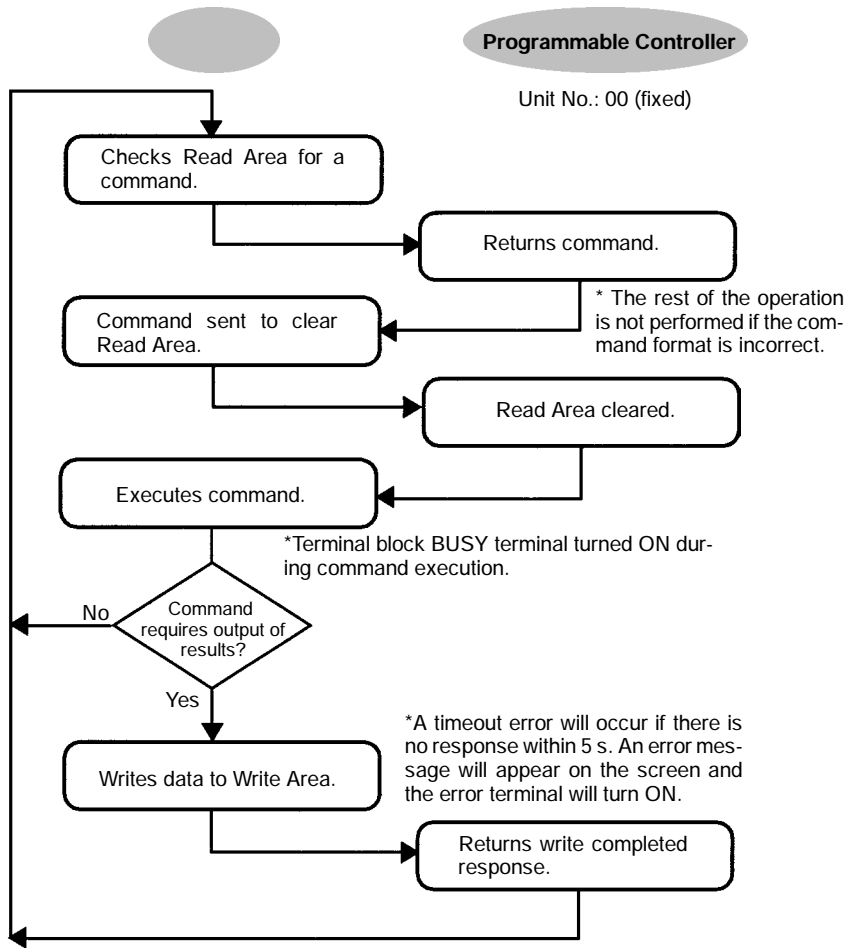

Inputting Measurement Trigger from STEP Terminal

If measurement triggers are to be input from the STEP terminal, set the Read Area to "None."

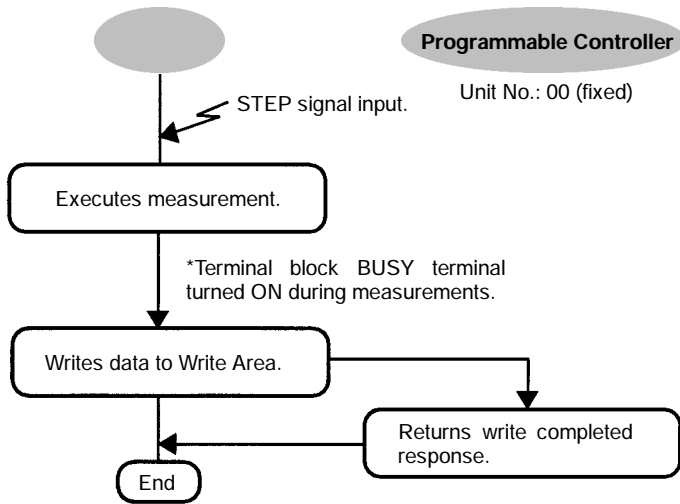

*A timeout error will occur if there is no response within 5 s. An error message will appear on the screen and the error terminal will turn ON.

Input the next STEP signal after all data output has been completed.

Using TXD Instructions

Commands are sent from the Programmable Controller to the F150 using TXD instructions in the Programmable Controller's ladder program instead of the Read Area.

If TXD instructions are to be used to send commands, set the Read Area to "None."

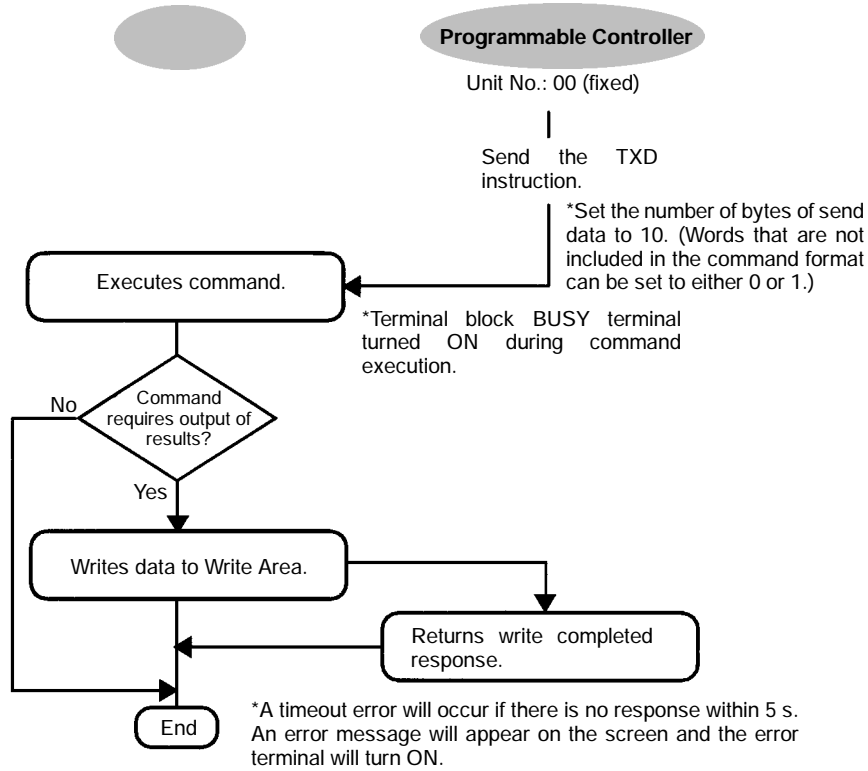

9-1-2 Communications Settings

Baud Rate and Communications Mode

The following explains how to set the baud rate, data length, and other communications specifications.

The same communications settings must be used on both the F150 and the external device (Programmable Controller).

Item	Setting	
Baud rate	2,400/4,800/9,600/19,200/ 38,400* (bps)	Use the same settings on the Programmable Controller.
Data length	7, 8* (bits)	
Parity bits	None*, even, odd	
Stop bits	1*, 2 (bits)	Use at a baud rate of 9,600 bps or less.
Delimiter	CR*, LF, CR+LF	
Mode	Normal*, Host Link, Menu. Select Host Link	

Note The default settings are marked with asterisks (*).

Procedure

- 1 Display the Basic Screen for Monitor mode or Run mode.



2 Move the cursor to **MON** or **RUN** and press the **ENT** Key.

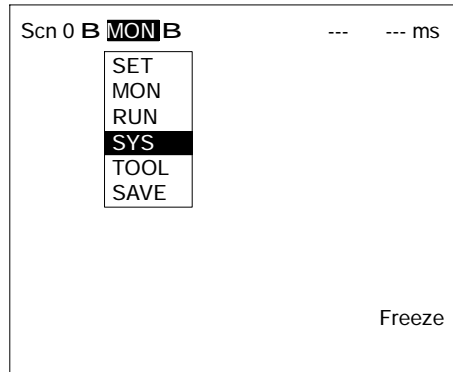

3 Select **SYS**.

4 Select **Communications**.

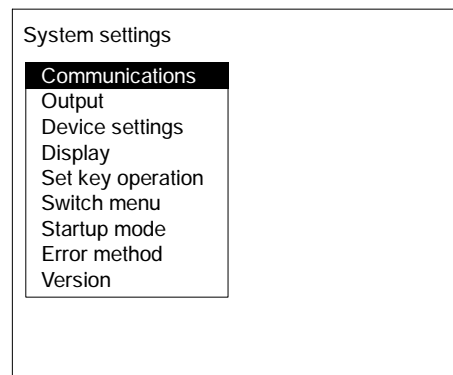

5 Select **RS-232C**.

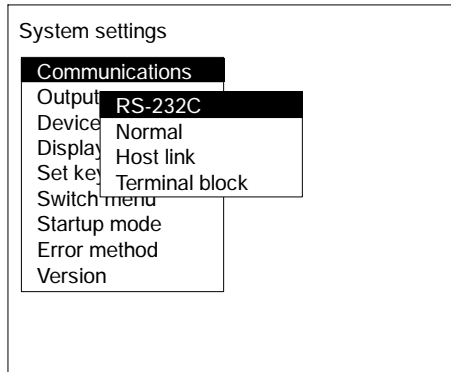

6 Set the items.

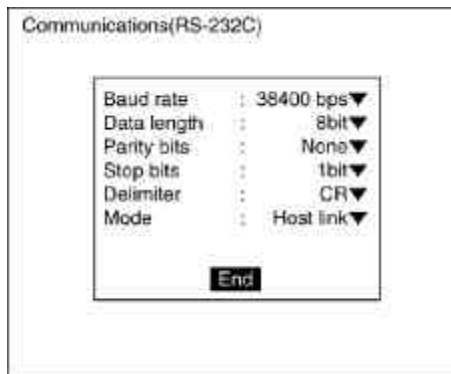

7 Select **End** to enter the settings.

Setting the Read and Write Areas in the Programmable Controller

This section explains how to set the Read Area from which the F150 reads commands and the Write Area to which the F150 outputs results. Both of these areas are in the memory of the Programmable Controller.

Item		Selection
Read Area		Select the Read Area from which the F150 reads commands. I/O*, HR (holding relay), LR (link relay), DM (data memory), None (See note 2.)
Begin read word		Set the first word to read in area specified above (0 to 9995). The default setting is 0.
Write Area		Select the Write Area to which the F150 outputs results. I/O*, HR (holding relay), LR (link relay), DM (data memory), None (See note 3.)
Begin write word		Set the first word to write in the area specified above (0 to 9996). The default is 100.
Programmable Controller mode check	ON*	Checks the mode of the Programmable Controller when the F150 enters Monitor or Run mode. Measurement will not be performed unless the Programmable Controller is in Monitor mode. (An error message will be displayed.)
	OFF	Sends a command to the Programmable Controller to change mode to Monitor mode when the F150 enters Monitor or Run mode.

- Note**
1. The default settings are marked with asterisks (*).
 2. When the read area setting is "None," the F150 will not read data. However, TXD instructions are received.
 3. When the write area setting is "None," the F150 will not output data.

Procedure

1 Select **Host link**.

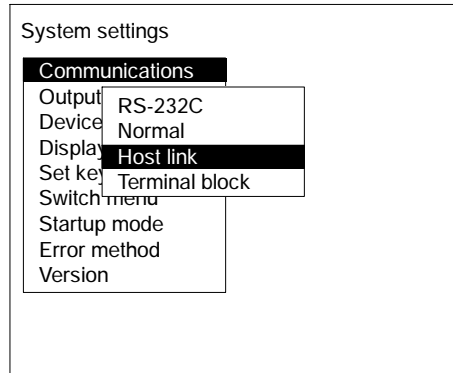

2 Set the items.

Refer to the following page for details on inputting values: → **p. 26**

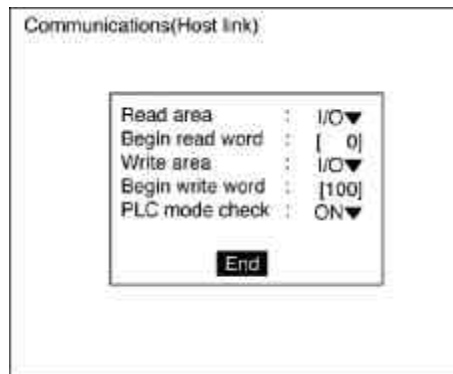

3 Select **End** to enter the settings.

9-2 Command Tables

The following commands can be input from the host device to the F150.

Set the command to be executed in the Read Area of the Programmable Controller.

Commands that Control F150 Operation

The following commands control F150 operation.

Command code	Function	Page
0010	Executes one measurement.	240
0011	Starts continuous measurement.	241
0012	Stops continuous measurement.	241
0020	Changes to a specified scene number.	241
0021	Increases the displayed scene number by one.	241
0022	Decreases the displayed scene number by one.	241
0040	Registers the model.	242
0066	Saves all data to flash memory.	242
0092	Resets the F150.	243

Commands that Read Measurement Results

The following commands read the results of the most recent measurement.

Command code	Function	Page
0080	Reads measurement results of the measurement region.	243
1210	Reads distances scrolled for position displacement compensation.	255
1220	Reads calculation results for judgement output expressions.	258
1221	Reads calculation results for data output expressions.	259

Commands that Read Current Settings

The following commands read settings such as evaluation criteria. F150 operation can be controlled from the host while monitoring F150 settings.

Command code	Function	Page
0023	Reads number of currently displayed scene.	242
1070	Reads parameters for measurement region.	251
1110	Reads evaluation criteria for judgement output expressions.	253
1130	Reads light level of Intelligent Light Source.	254

Commands that Change F150 Settings

The following commands perform settings such as for evaluation criteria. F150 operation can be controlled from the host while monitoring F150 settings.

Command code	Function	Page
1060	Sets parameters for measurement region.	246
1100	Sets evaluation criteria for judgement output expressions.	252
1120	Sets light level of Intelligent Light Source.	254

9-3 Input Format

This section explains the command formats in order of the command codes. Commands are input in BCD. Set the commands starting from the begin read word of the Read Area. The "-" indicates that either 0 or 1 can be set.

9-3-1 0010: ONE MEASUREMENT

Executes one measurement.

Input

Begin read word	Bits				Setting
	15 to 12	11 to 8	7 to 4	3 to 0	
+0	0000	0000	0001	0000	Command code

The measurement results are output. → p 260

9-3-2 0011: CONTINUOUS MEASUREMENT

Starts continuous measurement.

Input

Begin read word	Bits				Setting
	15 to 12	11 to 8	7 to 4	3 to 0	
+0	0000	0000	0001	0001	Command code

The measurement results are output. → p 260

9-3-3 0012: STOP MEASUREMENT

Stops continuous measurement.

Input

Begin read word	Bits				Setting
	15 to 12	11 to 8	7 to 4	3 to 0	
+0	0000	0000	0001	0010	Command code

9-3-4 0020: SWITCH SCENE

Switches to a specified scene number.

Input

Begin read word	Bits				Setting
	15 to 12	11 to 8	7 to 4	3 to 0	
+0	0000	0000	0010	0000	Command code
+1	----	----	10's digit	1's digit	Scene No. (00 to 15)

9-3-5 0021: INCREMENT SCENE

Increments the current scene number.

If the current scene number is 15, switches to scene 0.

Input

Begin read word	Bits				Setting
	15 to 12	11 to 8	7 to 4	3 to 0	
+0	0000	0000	0010	0001	Command code

9-3-6 0022: DECREMENT SCENE

Decrements the current scene number.

If the current scene number is 0, switches to scene 15.

Input

Begin read word	Bits				Setting
	15 to 12	11 to 8	7 to 4	3 to 0	
+0	0000	0000	0010	0010	Command code

9-3-7 0023: READ SCENE NUMBER

Reads the currently displayed scene number.

Input

Begin read word	Bits				Setting
	15 to 12	11 to 8	7 to 4	3 to 0	
+0	0000	0000	0010	0011	Command code

Output

Begin write word	Bits				Setting
	15 to 12	11 to 8	7 to 4	3 to 0	
+0	Write Flag	0000	0000	0000	Write Flag
+1	0000	0000	10's digit	1's digit	Scene No. (00 to 15)

Write Flag: Changes between 0000 and 1111 each time data is output. Monitor the flag to check if the data has been written.

9-3-8 0040: MODEL REGISTER

Re-registers the model based on the currently displayed image. (With through display, re-registers the model based on the measurement image input immediately before.) Only valid when the measurement method for the specified region is gray search or precise search. If any other regions are specified the command will be ignored.

Input

Begin read word	Bits				Setting
	15 to 12	11 to 8	7 to 4	3 to 0	
+0	0000	0000	0100	0000	Command code
+1	----	----	10's digit	1's digit	Region No. (00 to 15)

Two-camera Operation

If the camera mode is Two-camera Switching mode, since MODELSET registers the image currently displayed, display the region for the desired Camera before execution. Use the **Up/Down** Console Keys to switch Camera images.

9-3-9 0066: SAVE DATA

Saves all data to flash memory.

Input

Begin read word	Bits				Setting
	15 to 12	11 to 8	7 to 4	3 to 0	
+0	0000	0000	0110	0110	Command code

9-3-10 0092: RESET

Resets the F150.

Input

Begin read word	Bits				Setting
	15 to 12	11 to 8	7 to 4	3 to 0	
+0	0000	0000	1001	0010	Command code

9-3-11 0080: READ MEASUREMENT

Reads measurement results for the region measured last.

Input

Begin read word	Bits				Setting
	15 to 12	11 to 8	7 to 4	3 to 0	
+0	0000	0000	1000	0000	Command code
+1	10's digit of region number	1's digit of region number	10's digit of data type	1's digit of data type	Region No. (00 to 15) Data type (00 to 13)

Output

Begin write word	Bits				Setting
	15 to 12	11 to 8	7 to 4	3 to 0	
+0	Write Flag	0000	0000	0000	Write Flag
+1	1,000's digit	100's digit	10's digit	1's digit	Rightmost 4 digits of integral portion.
+2	Sign	1,000,000's digit	100,000's digit	10,000's digit	Leftmost 3 digits of integral portion and sign.
+3	0000	1st decimal	2nd decimal	3rd decimal	Decimal portion

Write Flag: Changes between 0000 and 1111 each time data is output. Monitor the flag to check if the data has been written.

Sign: Positive: 0000, Negative: 1111

Data Types

The data types that can be read will vary according to the measurement method for the specified region.

Binary Center of Gravity and Area, Binary Center of Gravity and Axis Angle

Parameter	Meaning
00	Judgement result (0: OK, -1: NG, -2: no measurement)
01	X coordinate of measured center of gravity
02	Y coordinate of measured center of gravity
03	X coordinate of reference center of gravity
04	Y coordinate of reference center of gravity
05	Displacement in X direction (measured X coordinate of center of gravity - reference X coordinate of center of gravity)
06	Displacement in Y direction (measured Y coordinate of center of gravity - reference Y coordinate of center of gravity)
07	Measured value for area
08	Reference value for area
09	Difference between reference and measured area
10	Inverted area (area of measurement region - measured area)
11	Measured axis angle
12	Reference axis angle
13	Axis displacement (measured axis angle - reference axis angle)

Note Parameters 11 to 13 are only used when measurement method is binary center of gravity and axis angle.

Gray Edge Position

Parameter	Meaning
00	Judgement result (0: OK, -1: NG, -2: no measurement)
01	Measured edge coordinate
02	Reference edge coordinate
03	Displacement (measured coordinate - reference coordinate)

Surface Defect

Parameter	Meaning
00	Judgement result (0: OK, -1: NG, -2: no measurement)
01	Measured defect
02	Maximum density value
03	Minimum density value

Density Averaging

Parameter	Meaning
00	Judgement result (0: OK, -1: NG, -2: no measurement)
01	Measured average density
02	Reference average density
03	Difference between measured average density and reference average density

Gray Search, Precise Search

Parameter	Meaning
00	Judgement result (0: OK, -1: NG, -2: no measurement)
01	Measured X coordinate
02	Measured Y coordinate
03	Reference X coordinate
04	Reference Y coordinate
05	Displacement in X direction (measured X coordinate - reference X coordinate)
06	Displacement in Y direction (measured Y coordinate - reference Y coordinate)
07	Correlation value

Edge Pitch

Parameter	Meaning
00	Judgement result (0: OK, -1: NG, -2: no measurement)
01	Number of detected objects
02	Average pitch
03	Maximum pitch
04	Minimum pitch
05	Average width
06	Maximum width
07	Minimum width

Relative Search

Parameter	Meaning
00	Judgement result (0: OK, -1: NG, -2: no measurement)
01	Measured X width
02	Measured Y width
03	Measured distance
04	Reference X width
05	Reference Y width
06	Reference distance
07	Difference in X widths (measured width - reference width)
08	Difference in Y widths (measured width - reference width)
09	Difference in distances (measured distance - reference distance)
10	Correlation with model 0
11	Correlation with model 1

9-3-12 1060: SET PARAMETER

Sets parameters for measurement regions.

Input

Begin read word	Bits				Setting
	15 to 12	11 to 8	7 to 4	3 to 0	
+0	0001	0000	0110	0000	Command code
+1	10's digit of region number	1's digit of region number	10's digit of data type	1's digit of data type	Region No. (00 to 15) Data type (00 to 14)
+2	1,000's digit	100's digit	10's digit	1's digit	Rightmost 4 digits of integral portion of setting data.
+3	Sign	1,000,000's digit	100,000's digit	10,000's digit	Leftmost 3 digits of integral portion of setting data and sign.
+4	0000	1st decimal	2nd decimal	3rd decimal	Decimal portion of setting data.

Data Types

The data types that can be set will vary according to the measurement method for the specified region.

Binary Center of Gravity and Area, Binary Center of Gravity and Axis Angle

Parameter	Meaning
00	Upper limit of X coordinate of center of gravity (-9,999.999 to 9,999.999)
01	Lower limit of X coordinate of center of gravity (-9,999.999 to 9,999.999)
02	Upper limit of Y coordinate of center of gravity (-9,999.999 to 9,999.999)
03	Lower limit of Y coordinate of center of gravity (-9,999.999 to 9,999.999)
04	Upper limit of area (0 to 9,999,999.999)
05	Lower limit of area (0 to 9,999,999.999)
06	Upper-left X coordinate of region (0 to 511)
07	Upper-left Y coordinate of region (0 to 483)
08	Lower-right X coordinate of region (0 to 511)
09	Lower-right Y coordinate of region (0 to 483)
10	Upper limit of binary level (0 to 255)
11	Lower limit of binary level (0 to 255)
12	Binary level inversion (0: not inverted, 1: inverted)
13	Upper limit of axis angle (-180.000 to 180.000)
14	Lower limit of axis angle (-180.000 to 180.000)

Note Parameters 13 and 14 are only used when measurement method is binary center of gravity and axis angle.

Gray Edge Position

Parameter	Meaning
00	Upper limit of position (-9,999.999 to 9,999.999)
01	Lower limit of position (-9,999.999 to 9,999.999)
02	Upper-left X coordinate of region (0 to 511)
03	Upper-left Y coordinate of region (0 to 483)
04	Lower-right X coordinate of region (0 to 511)
05	Lower-right Y coordinate of region (0 to 483)
06	Edge search direction (↑: 0, ↓: 1, →: 2, ←: 3)
07	Edge color (Light → Dark: 0, Dark → Light: 1)
08	Level (0 to 100)

Gray Search, Precise Search

Parameter	Meaning
00	Upper limit of X coordinate (-9,999.999 to 9,999.999)
01	Lower limit of X coordinate (-9,999.999 to 9,999.999)
02	Upper limit of Y coordinate (-9,999.999 to 9,999.999)
03	Lower limit of Y coordinate (-9,999.999 to 9,999.999)
04	Upper limit of correlation value (0 to 100)
05	Lower limit of correlation value (0 to 100)
06	Upper-left X coordinate of search region (0 to 511)
07	Upper-left Y coordinate of search region (0 to 483)
08	Lower-right X coordinate of search region (0 to 511)
09	Lower-right Y coordinate of search region (0 to 483)
10	X coordinate of reference position (0 to 511)
11	Y coordinate of reference position (0 to 483)
12	Search speed (0: LOW → 1 → 2 → 3 → 4: HIGH)

Edge Pitch

Parameter	Meaning
00	Upper limit of number of objects (0 to 255)
01	Lower limit of number of objects (0 to 255)
02	Upper limit of pitch (0 to 9,999.999)
03	Lower limit of pitch (0 to 9,999.999)
04	Upper limit of width (0 to 9,999.999)
05	Lower limit of width (0 to 9,999.999)
06	Upper-left X coordinate of region (0 to 511)
07	Upper-left Y coordinate of region (0 to 483)
08	Lower-right X coordinate of region (0 to 511)
09	Lower-right Y coordinate of region (0 to 483)
10	Counted object color (White: 0, Black: 1)
11	Edge level (0 to 100)
12	Minimum level (0 to 255)

Density Averaging

Parameter	Meaning
00	Upper limit of average density (0.000 to 255.000)
01	Lower limit of average density (0.000 to 255.000)
02	Upper-left X coordinate of region (0 to 511)
03	Upper-left Y coordinate of region (0 to 483)
04	Lower-right X coordinate of region (0 to 511)
05	Lower-right Y coordinate of region (0 to 483)

Relative Search

Parameter	Meaning
00	Upper limit of width X (-9999.999 to 9999.999)
01	Lower limit of width X (-9999.999 to 9999.999)
02	Upper limit of width Y (-9999.999 to 9999.999)
03	Lower limit of width Y (-9999.999 to 9999.999)
04	Upper limit of distance (0 to 9999.999)
05	Lower limit of distance (0 to 9999.999)
06	Upper limit of correlation with model 0 (0 to 100)
07	Lower limit of correlation with model 0 (0 to 100)
08	Upper limit of correlation with model 1 (0 to 100)
09	Lower limit of correlation with model 1 (0 to 100)
10	Upper-left X coordinate of search region for model 0 (0 to 511)
11	Upper-left Y coordinate of search region for model 0 (0 to 483)
12	Lower-right X coordinate of search region for model 0 (0 to 511)
13	Lower-right Y coordinate of search region for model 0 (0 to 483)
14	Upper-left X coordinate of search region for model 1 (0 to 511)
15	Upper-left Y coordinate of search region for model 1 (0 to 483)
16	Lower-right X coordinate of search region for model 1 (0 to 511)
17	Lower-right Y coordinate of search region for model 1 (0 to 483)
18	X coordinate of reference position for model 0 (0 to 511)
19	Y coordinate of reference position for model 0 (0 to 483)
20	X coordinate of reference position for model 1 (0 to 511)
21	Y coordinate of reference position for model 1 (0 to 483)
22	Search speed (0: LOW → 1 → 2 → 3 → 4: HIGH)

Surface Defect

Parameter	Meaning
00	Defect (0 to 255)
01	Upper limit of density value (0 to 255)
02	Lower limit of density value (0 to 255)
03	Element size (4 to 80)
04	Compare pitch (1 to 6)
05 to 10	See note

Note The meanings of parameters 5 to 10 vary according to the shape of the region.

Parameter	Box	Line	Circumference	Arc
05	Upper-left X coordinate of region (0 to 511)	X coordinate of start point (0 to 511)	X coordinate of center (0 to 511)	X coordinate of center (0 to 511)
06	Upper-left Y coordinate of region (0 to 483)	Y coordinate of start point (0 to 483)	Y coordinate of center (0 to 483)	Y coordinate of center (0 to 483)
07	Lower-right X coordinate of region (0 to 511)	X coordinate of end point (0 to 511)	Radius (1 to 512)	Radius (1 to 512)
08	Lower-right Y coordinate of region (0 to 483)	Y coordinate of end point (0 to 483)	Width (1 to 64)	Width (1 to 64)
09	---	Width (1 to 64)	---	Start angle (-180.00 to 180.00)
10	---	---	---	End angle (-180.00 to 180.00)

9-3-13 1070: READ PARAMETER

Reads parameters for measurement regions. The data types are the same as for command 1060. Refer to the parameter lists above.

Input

Begin read word	Bits				Setting
	15 to 12	11 to 8	7 to 4	3 to 0	
+0	0001	0000	0111	0000	Command code
+1	10's digit of region number	1's digit of region number	10's digit of data type	1's digit of data type	Region No. (00 to 15) Data type (00 to 14)

Output

Begin write word	Bits				Setting
	15 to 12	11 to 8	7 to 4	3 to 0	
+0	Write Flag	0000	0000	0000	Write Flag
+1	1,000's digit	100's digit	10's digit	1's digit	Rightmost 4 digits of integral portion
+2	Sign	1,000,000's digit	100,000's digit	10,000's digit	Leftmost 3 digits of integral portion and sign
+3	0000	1st decimal	2nd decimal	3rd decimal	Decimal portion

Write Flag: Changes between 0000 and 1111 each time data is output. Monitor the flag to check if the data has been written.

Sign: Positive: 0000, Negative: 1111

9-3-14 1100: SET JUDGEMENT OUTPUT EXPRESSION CRITERIA

Sets evaluation criteria for judgement output expressions.

Input

Begin read word	Bits				Setting
	15 to 12	11 to 8	7 to 4	3 to 0	
+0	0001	0001	0000	0000	Command code
+1	0000	Type	10's digit	1's digit	Judgement number (00 to 15) and type
+2	1,000's digit	100's digit	10's digit	1's digit	Rightmost 4 digits of integral portion
+3	Sign	1,000,000's digit	100,000's digit	10,000's digit	Leftmost 3 digits of integral portion and sign
+4	0000	1st decimal	2nd decimal	3rd decimal	Decimal portion

Type: Upper limit: 0000, Lower limit: 0001

Sign: Positive: 0000, Negative: 1111

**9-3-15 1110: READ JUDGEMENT OUTPUT
EXPRESSION CRITERIA**

Reads evaluation criteria for judgement output expressions.

Input

Begin read word	Bits				Setting
	15 to 12	11 to 8	7 to 4	3 to 0	
+0	0001	0001	0001	0000	Command code
+1	0000	Type	10's digit of judgement number	1's digit of judgement number	Judgement number (00 to 15) and type

Type: Upper limit: 0000, Lower limit: 0001

Output

Begin write word	Bits				Setting
	15 to 12	11 to 8	7 to 4	3 to 0	
+0	Write Flag	0000	0000	0000	Write Flag
+1	1,000's digit	100's digit	10's digit	1's digit	Rightmost 4 digits of integral portion
+2	Sign	1,000,000's digit	100,000's digit	10,000's digit	Leftmost 3 digits of integral portion and sign.
+3	0000	1st decimal	2nd decimal	3rd decimal	Decimal portion

Write Flag: Changes between 0000 and 1111 each time data is output. Monitor the flag to check if the data has been written.

Sign: Positive: 0000, Negative: 1111

9-3-16 1120: SET LIGHT LEVEL

Sets the light level for the Intelligent Light Source.

Input

Begin read word	Bits				Setting
	15 to 12	11 to 8	7 to 4	3 to 0	
+0	0001	0001	0010	0000	Command code
+1	0000	0000	0000	Camera number	Camera number (0 or 1)
+2	Light level for section B	Light level for section C	Light level for section D	Light level for section E	Light level for each section (0 to 7; 0 = unlit)
+3	0000	0000	0000	Light level for section A	
+4	0000	Light level for section F	Light level for section G	Light level for section H	

F150-LTC20



F to H always set to 0

F150-LTC50

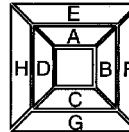

9-3-17 1130: READ LIGHT LEVEL

Reads the light level for the Intelligent Light Source. For details of the positions of the sections, refer to 1120: SET LIGHT LEVEL.

Input

Begin read word	Bits				Setting
	15 to 12	11 to 8	7 to 4	3 to 0	
+0	0001	0001	0011	0000	Command code
+1	0000	0000	0000	Camera number	Camera number (0 or 1)

Output

Begin write word	Bits				Setting
	15 to 12	11 to 8	7 to 4	3 to 0	
+0	Write Flag	0000	0000	0000	Write Flag
+1	Light level for section B	Light level for section C	Light level for section D	Light level for section E	Light level for each section (0 to 7; 0 = unlit)
+2	0000	0000	0000	Light level for section A	
+3	0000	Light level for section F	Light level for section G	Light level for section H	

Write Flag: Changes between 0000 and 1111 each time data is output. Monitor the flag to check if the data has been written.

9-3-18 1210: READ POSITION

Reads measurement values related to position displacement compensation for most recent measurement.

Input

Begin read word	Bits				Setting
	15 to 12	11 to 8	7 to 4	3 to 0	
+0	0001	0010	0001	0000	Command code
+1	0000	Region No.	10's digit of data type	1's digit of data type	Region No. (0 or 1; to read displacement: 2) Data type (00 to 13)

Two-camera Operation If two Cameras are used, specify 0 or 1 (for **Position compensation 0**), or 10 or 11 (for **Position compensation 1**) for the region number. To read the displacement, specify 2 (for **Position compensation 0**) or 12 (for **Position compensation 1**).

Output

Begin write word	Bits				Setting
	15 to 12	11 to 8	7 to 4	3 to 0	
+0	Write Flag	0000	0000	0000	Write flag
+1	1,000's digit	100's digit	10's digit	1's digit	Rightmost 4 digits of integral portion
+2	Sign	1,000,000's digit	100,000's digit	10,000's digit	Leftmost 3 digits of integral portion and sign
+3	0000	1st decimal	2nd decimal	3rd decimal	Decimal portion

Write Flag: Changes between 0000 and 1111 each time data is output. Monitor the flag to check if the data has been written.

Sign: Positive: 0000, Negative: 1111

Data Types

The data types that can be read will vary according to the measurement method for the specified region.

Gray Edge Position

Parameter	Meaning
00	Judgement result (0: OK, -1: NG, -2: no measurement)
01	Measured edge coordinate
02	Reference edge coordinate
03	Displacement (measured coordinate - reference coordinate)

Position Displacement

Parameter	Meaning
00	Displacement in X direction (reference X coordinate - measured X coordinate)
01	Displacement in Y direction (reference Y coordinate - measured Y coordinate)
02	Angle displacement (reference angle - measured angle)

Binary Center of Gravity and Area, Binary Center of Gravity and Axis Angle

Parameter	Meaning
00	Judgement result (0: OK, -1: NG, -2: no measurement)
01	X coordinate of measured center of gravity
02	Y coordinate of measured center of gravity
03	X coordinate of reference center of gravity
04	Y coordinate of reference center of gravity
05	Displacement in X direction (measured X coordinate of center of gravity - reference X coordinate of center of gravity)
06	Displacement in Y direction (measured Y coordinate of center of gravity - reference Y coordinate of center of gravity)
07	Measured value for area
08	Reference value for area
09	Difference between reference and measured area
10	Inverted area (area of measurement region - measured area)
11	Measured axis angle
12	Reference axis angle
13	Axis displacement (measured axis angle - reference axis angle)

Note Parameters 11 to 13 are only used when the measurement method is binary center of gravity and axis angle.

Gray Search

Parameter	Meaning
00	Judgement result (0: OK, -1: NG, -2: no measurement)
01	Measured X coordinate
02	Measured Y coordinate
03	Reference X coordinate
04	Reference Y coordinate
05	Displacement in X direction (measured X coordinate - reference X coordinate)
06	Displacement in Y direction (measured Y coordinate - reference Y coordinate)
07	Correlation value

**9-3-19 1220: READ JUDGEMENT OUTPUT
EXPRESSION RESULT**

Reads calculation results of judgement output expressions for the most recent measurement.

Input

Begin read word	Bits				Setting
	15 to 12	11 to 8	7 to 4	3 to 0	
+0	0001	0010	0010	0000	Command code
+1	0000	0000	10's digit	1's digit	Judgement number (00 to 15)

Output

Begin write word	Bits				Setting
	15 to 12	11 to 8	7 to 4	3 to 0	
+0	Write Flag	0000	0000	0000	Write Flag
+1	1,000's digit	100's digit	10's digit	1's digit	Rightmost 4 digits of integral portion of calculation result
+2	Sign	1,000,000's digit	100,000's digit	10,000's digit	Leftmost 3 digits of integral portion of calculation result and sign
+3	0000	1st decimal	2nd decimal	3rd decimal	Decimal portion

Write Flag: Changes between 0000 and 1111 each time data is output. Monitor the flag to check if the data has been written.

Sign: Positive: 0000, Negative: 1111

9-3-20 1221: READ DATA OUTPUT EXPRESSION RESULT

Reads calculation results of data output expressions for the most recent measurement.

Input

Begin read word	Bits				Setting
	15 to 12	11 to 8	7 to 4	3 to 0	
+0	0001	0010	0010	0001	Command code
+1	0000	0000	0000	1's digit	Data number (0 to 7)

Output

Begin write word	Bits				Setting
	15 to 12	11 to 8	7 to 4	3 to 0	
+0	Write Flag	0000	0000	0000	Write Flag
+1	1,000's digit	100's digit	10's digit	1's digit	Rightmost 4 digits of integral portion calculation result
+2	Sign	1,000,000's digit	100,000's digit	10,000's digit	Leftmost 3 digits of integral portion of calculation result and sign
+3	0000	1st decimal	2nd decimal	3rd decimal	Decimal portion

Write Flag: Changes between 0000 and 1111 each time data is output. Monitor the flag to check if the data has been written.

Sign: Positive: 0000, Negative: 1111

9-4 Output Format

When a measurement is executed, the results are output in BCD to the Write Area of the Programmable Controller. The output will be in order, starting with the smallest output number.

Write Flag switches between 0000 and 1111 each time data is output. Monitor this flag to see when measurement results have been written. The Write Flag will be 0000 after the first measurement and so set the flag to an initial setting of 1111.

Begin write word	Bits				Setting
	15 to 12	11 to 8	7 to 4	3 to 0	
+0	Write Flag	0000	0000	0000	Write Flag
+1	1,000's digit	100's digit	10's digit	1's digit	Rightmost 4 digits of integral portion
+2	Sign	1,000,000's digit	100,000's digit	10,000's digit	Leftmost 3 digits of integral portion and sign
+3	0000	1st decimal	2nd decimal	3rd decimal	Decimal portion

0000: Positive
1111: Negative

Calibrated values are output.

Measurements from -9,999,999.999 to 9,999,999.999 can be output.

Measurements less than -9,999,999.999 are output as "-9,999,999.999."

Measurement greater than 9,999,999.999 are output as "9,999,999.999."

When the output is set to a judgment, the output will be one of the following:

OK: 0

NG: -1

Note The output of data after measurement is performed in Run mode, will continue until all of the data has been output, even if the mode is changed. Data output will not be interrupted.

Example 1:

Calculation result of 143.250 for data output 0.

No setting for data output 1.

Calculation result of -6943.298 for data output 2.

Begin write word	Bits				Setting
	15 to 12	11 to 8	7 to 4	3 to 0	
+0	0000	0000	0000	0000	Write Flag (0000)
+1	0000	0001	0100	0011	Rightmost 4 digits of integral portion
+2	0000	0000	0000	0000	Leftmost 2 digits of integral portion and sign
+3	0000	0010	0101	0000	Decimal portion
+4	0000	0000	0000	0000	Write Flag (0000)
+5	0110	1001	0100	0011	Rightmost 4 digits of integral portion
+6	1111	0000	0000	0000	Leftmost 2 digits of integral portion and sign
+7	0000	0010	1001	1000	Decimal portion

Data 0 {
Data 2 {

Output numbers for which settings have not been made are not output (as data output 1 above).

Example 2:

If expressions are set for all data outputs (0 to 7), the measurement results will be output in two groups.

Group 1: Calculation results for data outputs 0 to 6.

Group 2: Calculation result for data output 7.

Begin write word	Bits				Setting
	15 to 12	11 to 8	7 to 4	3 to 0	
+0	0000	0000	0000	0000	Write Flag (0000)
+1	0000	0001	0100	0011	Rightmost 4 digits of integral portion
+2	0000	0000	0000	0000	Leftmost 2 digits of integral portion and sign
+3	0000	0010	0101	0000	Decimal portion
⋮					
+ (4 x n) + 0	0000	0000	0000	0000	Write Flag (0000)
+ (4 x n) + 1	0110	1001	0100	0011	Rightmost 4 digits of integral portion
+ (4 x n) + 2	1111	0000	0000	0000	Leftmost 2 digits of integral portion and sign
+ (4 x n) + 3	0000	0010	1001	1000	Decimal portion
⋮					
+28	1111	0000	0000	0000	Write Flag (1111)
+29	0000	0001	0100	0011	Rightmost 4 digits of integral portion
+30	0000	0000	0000	0000	Leftmost 2 digits of integral portion and sign
+31	0000	0010	0101	0000	Decimal portion

Group 1

Group 2

9-5 Sample Ladder Program

This section provides a sample ladder program for the OMRON C200H/C200HS Programmable Controller.

In this program, the Run command is input from the Programmable Controller to the F150, and the judgement results are output back to the Programmable Controller from the F150.

Programmable Controller Settings

Use the following communications settings for a Host Link Unit on the Programmable Controller, or the Host Link port built into the CPU Unit.

Refer to the Programmable Controller manuals for detailed setting instructions.

Item	Setting
Communications protocol	SYSWAY (Host Link)
1:1/1:N	1:N
Unit no.	00
Baud rate	Make the same settings as for the F150.
Data length	
Parity bits	
Stop bits	

F150 Settings

Settings for Communications Specifications

Item	Setting
Baud rate	Make the same settings as for the Programmable Controller.
Data length	
Parity bits	
Stop bits	
Read Area	DM
Begin read word	0100
Write Area	DM
Begin write word	0105

Settings for Output Expressions

Go to **Expression/Data**, and make the following settings in data 0 and data 1.

Data 0: R0.JG

Data 1: R1.JG

Data Area Allocations

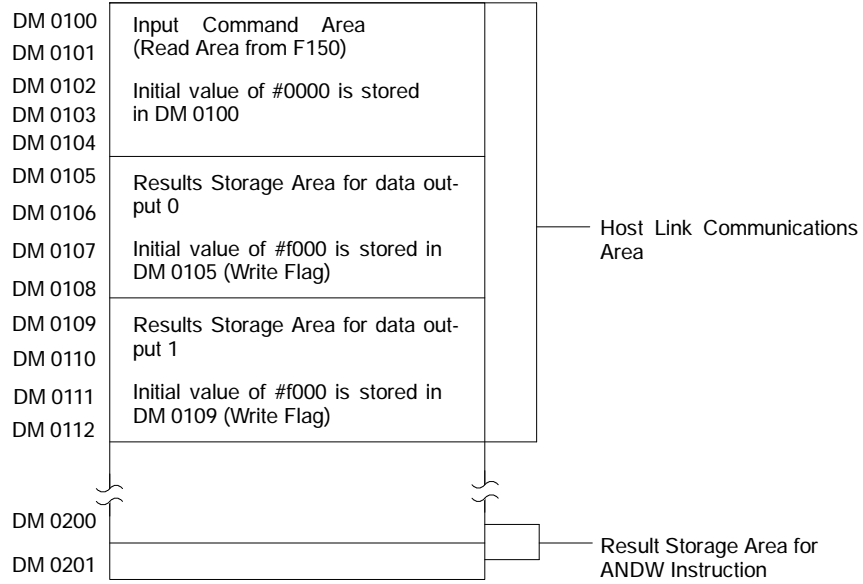

Ladder Diagram

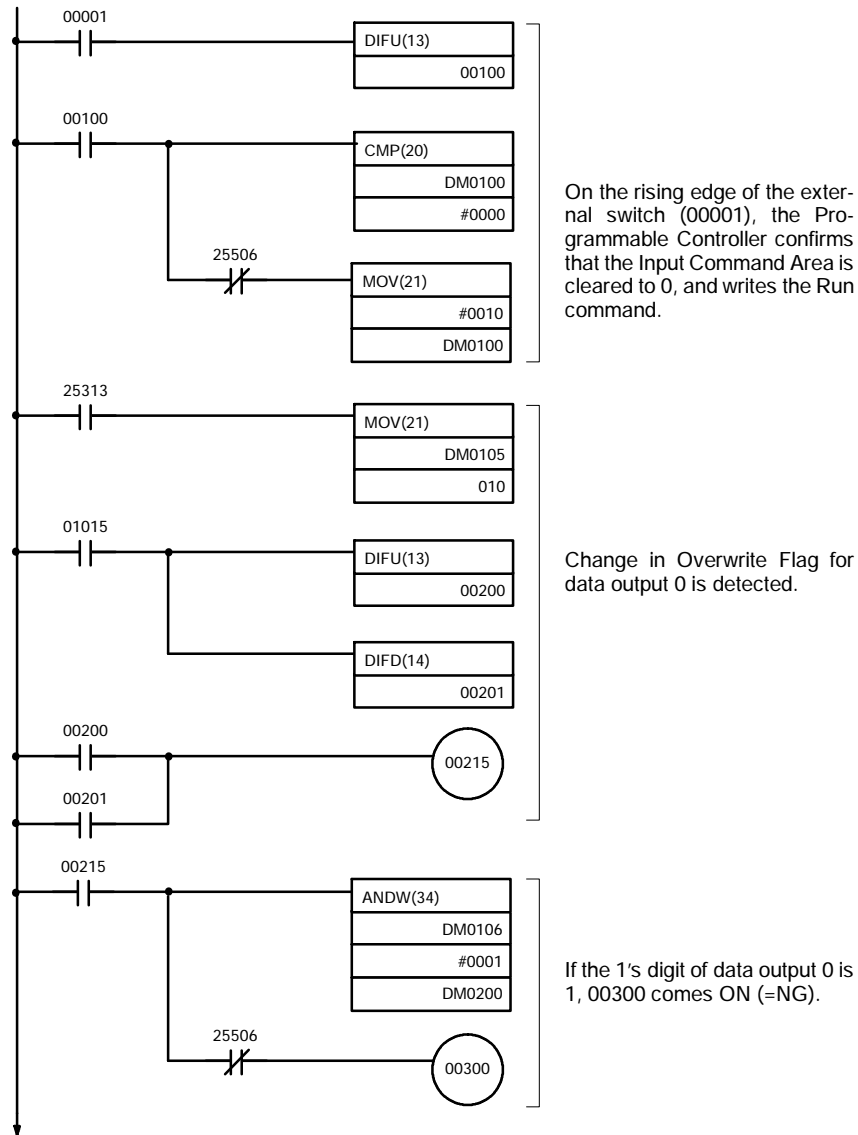

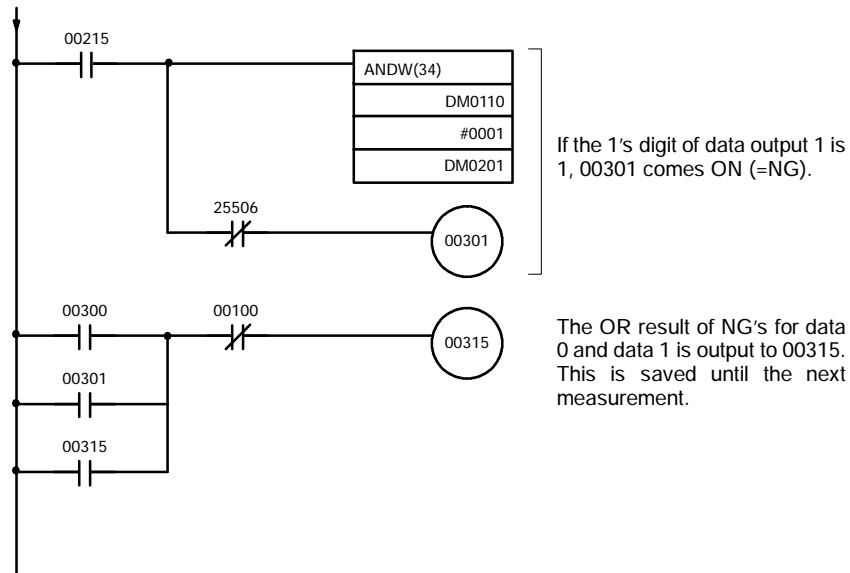

SECTION 10

CompoBus/D Settings

This section describes the communications settings required when the F150 is used as a CompoBus/D Slave.

CompoBus/D communications are only supported for the F150-C10E-3-DRT.

For details on the baud rate and node address settings, refer to the *Setup Manual*.

For detailed information relating to CompoBus/D, such as system configuration and cable connections, refer to the *CompoBus/D (DeviceNet) Operation Manual (W267)*.

10-1	Communications Settings	270
10-1-1	Communications Settings	273
10-1-2	Confirming CompoBus/D Communications Settings	277
10-2	Input Format	278
10-2-1	Basic Mode	278
10-2-2	Expand Mode	281
10-3	Output Format	301
10-3-1	Control Output (Word +0)	303
10-3-2	Judgement Output (+1)	304
10-3-3	F150 Status Output (+2)	305
10-3-4	Expand Command Response Output (+3 to 7) ...	305
10-3-5	Data Output in BCD or Binary (+3 to 26 or +8 to 31)	306
10-4	Timing Charts	309
10-4-1	Basic Mode	309
10-4-2	Expand Mode	312
10-5	Allocation Charts	315
10-6	Sample Ladder Program	318
10-6-1	Programmable Controller Settings	318
10-6-2	Allocations for Programmable Controller	318
10-6-3	Timing Charts	319
10-6-4	Ladder Program	321

10-1 Communications Settings

The F150-C10E-3-DRT operates as a CompoBus/D Slave. Data is automatically exchanged with the Master Unit using remote I/O.

- | | |
|---------------------|--|
| Set Mode | Command inputs cannot be received. |
| Monitor Mode | Command inputs can be received, but measurement results (judgement output and data output) are not output to external devices. Control output and F150 status output are supported, however. |
| Run Mode | Both command input and output of measurement results are supported. |

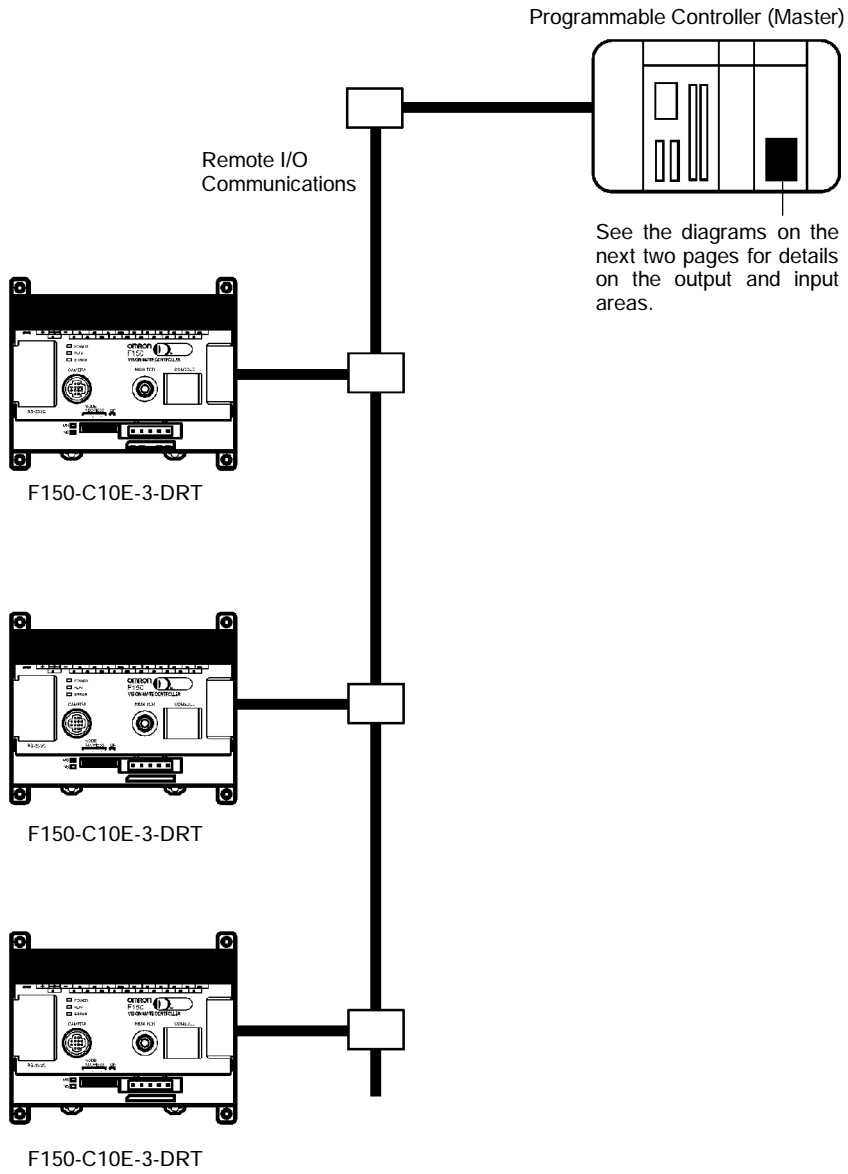

Output Area

Set operational commands to be sent to the F150 here. Select the input mode (Basic/Expand) in the communications specifications settings menu.

Basic

Word +0	Basic command (2 bytes)
---------	-------------------------

Only a small number of allocated areas are required.
Commands for measurement and scene changing can be used.

Expand

Word +0	Expand command (10 bytes)
Word +1	
Word +2	
Word +3	
Word +4	

A variety of commands other than the measurement command can be used, such as parameter setting and reading commands. Various F150's functions can be used.

Input Area

Measurement results are output from the F150 to this area.

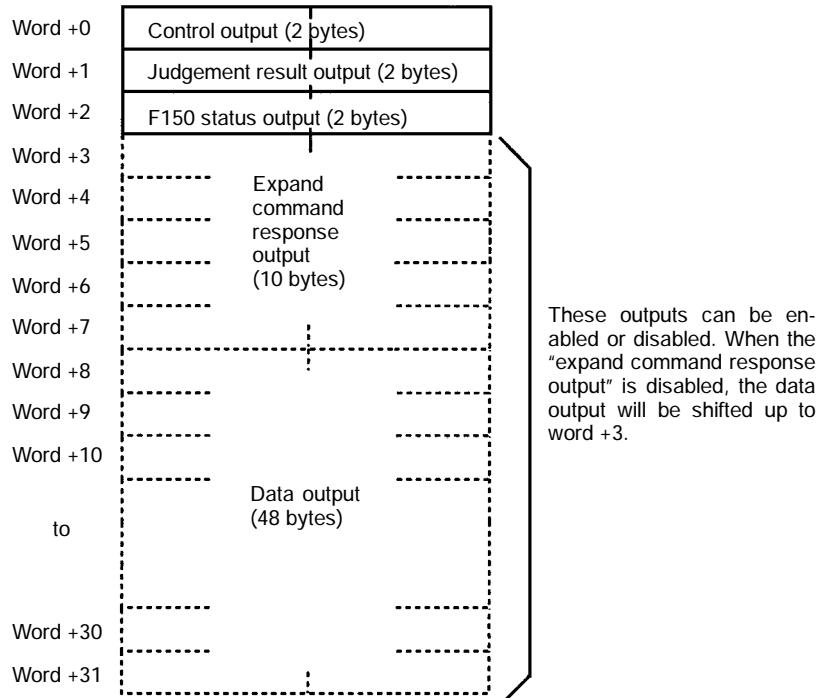

10-1-1 Communications Settings

This section explains the setting methods required for communications specifications when performing communications with the CompoBus/D.

Item	Selections	Details
Input mode	Basic (default setting)	Use this mode for measurement commands and scene changing. The number of allocated areas required in the Master in this mode is less than that required in Expand mode (2 bytes).
	Expand	In addition to measurement commands, commands for reading and setting parameters are also available. The number of allocated areas required in this mode is greater than that required in Basic mode (10 bytes).

Item	Selections	Details
GATE terminal control	Measure output (default setting)	The GATE terminal on the terminal block is used as a timing signal for obtaining measurement results output from the terminal block.
	Any output	The GATE terminal on the terminal block is controlled by commands, and used as required by the user. (e.g.: Lighting control, etc.)
Data output	OFF (default setting)	Measurement results (data) are not output. There are a fewer number of output bytes and so the number of allocated areas can be decreased.
	BCD	Measurement results (data) are output in BCD format.
	Binary	Measurement results (data) are output in binary format.
Response output	OFF (default setting)	Responses to expand commands are not output. There are a fewer number of output bytes and so the number of allocated areas can be decreased. However, even if commands for reading setting values are input, the values will not be output. Normally, if the input mode is Basic mode, this setting should be OFF.
	ON	Responses to expand commands are output. The command code for the executed command will be entered in the first read word. Commands that are executed can be monitored with this word.
Communications errors (see below)	Keep (default setting)	When a network error occurs, the data that was sent from the Programmable Controller to the F150 immediately before the error occurred (in the output area) is saved, and the F150 continues operation based on this data.
	Clear	When a network error occurs, the data sent from the Programmable Controller to the F150 is cleared to 0, and the F150 continues operation based on this data. The Command Enable Bit will also be reset to 0. Therefore, when the network error has been cleared, if the output area of the Programmable Controller is in the same state as it was when the error occurred, the same command will be executed twice.

Communications Errors

When a network error occurs, the status of data input from the Programmable Controller to the F150 via the network may change. Therefore, select the way the status of data input from the Programmable Controller to the F150 is to be defined when an error occurs.

Note Select CompoBus/D as the data output destination in **SYS/Output**. If RS-232C is selected, no value will be output to CompoBus/D regardless of whether BCD or binary is set for the data output format. → p. 155

Procedure

- 1 Display the Basic Screen for Monitor mode or Run mode.

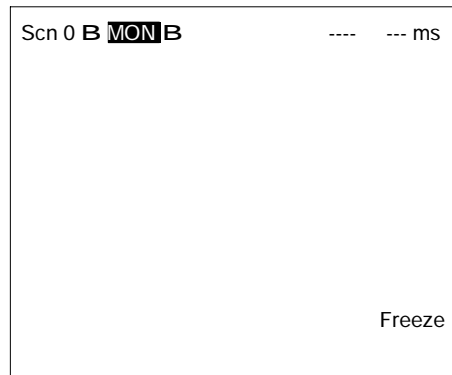

- 2 Move the cursor to **MON** or **RUN** and press the **ENT** Key.

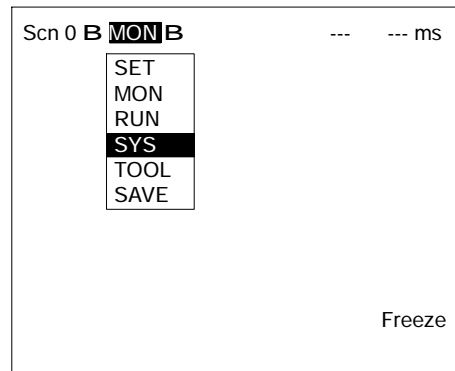

- 3 Select **SYS**.

4 Select *Communications*.

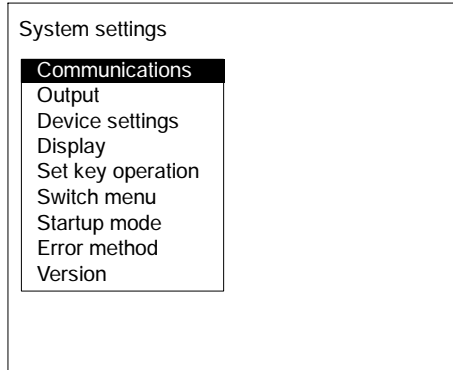

5 Select *CompoBus/D set*.

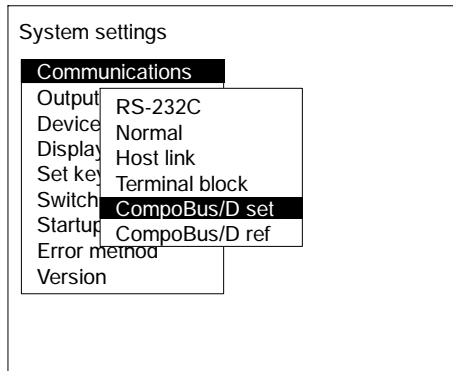

6 Set the required items.

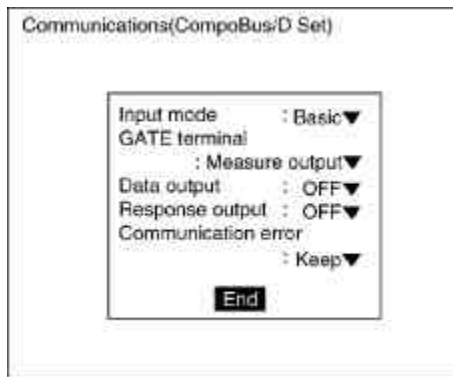

7 Select **End**.
A confirmation message will be displayed.

8 Select **OK**.

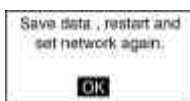

Note In order to register these settings it is necessary to save the settings to flash memory and restart the F150. Also, the number of I/O bytes will change in accordance with the new settings. Therefore, restart the whole network. → p. 179

10-1-2 Confirming CompoBus/D Communications Settings

CompoBus/D communications settings can be confirmed by displaying them on the screen. If an error occurs in CompoBus/D communications, take note of the contents of this screen and contact your OMRON representative.

Item	Details
ID	Vendor ID (A), product type (B), product code (C). <u>47, 0, 203</u> (A) (B) (C)
Rev.	DeviceNet specifications version.
Serial number	Serial number for the model. (20200001 on)
Baud rate	Baud rate set with DIP switch.
Node address	Node address set with DIP switch.
Number of input bytes	Depends on the input mode in the CompoBus/D settings. 2: Basic; 10: Expand
Number of output bytes	Depends on the data outputs and response outputs in the CompoBus/D settings. 6: Data output OFF; Response OFF 16: Data output OFF; Response ON 54: Data output BCD or binary; Response OFF 64: Data output BCD or binary; Response ON

Procedure

1 Select **CompoBus/D ref.**

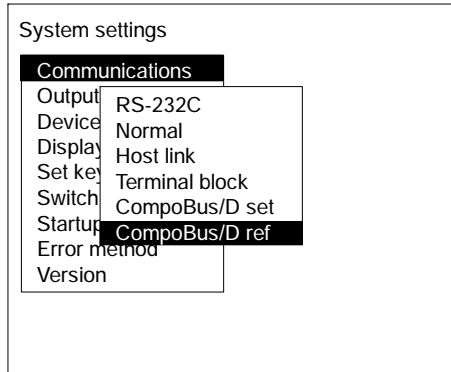

2 Select **OK** to exit this screen.

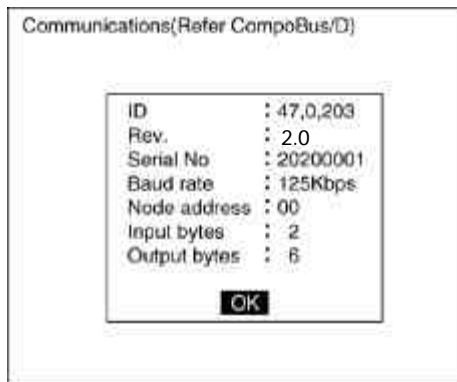

10-2 Input Format

This section explains the format of commands that are set in the output area of the Programmable Controller in order to control F150 operation.

10-2-1 Basic Mode

The word numbers given here are the offset values from the first word in the allocated area of the Master. The "-" indicates that either 0 or 1 can be set without affecting the setting.

ONE MEASUREMENT

When bit 8 turns ON, one measurement is executed.

Input Format**Section 10-2**

Word	Bits				Setting
	15 to 12	11 to 8	7 to 4	3 to 0	
+0	0000	-001	0000	----	Bit 8: one measurement

CONTINUOUS MEASUREMENT

Starts continuous measurement. Measurements are continued until the STOP MEASUREMENT is input. To input other commands, input the STOP MEASUREMENT command. If other commands are input while continuous measurement is being executed, continuous measurement will be stopped temporarily and start up again once processing for the input command has been completed.

Word	Bits				Setting
	15 to 12	11 to 8	7 to 4	3 to 0	
+0	0000	-000	1001	----	Bit 4: Start continuous measurement Bit 7: Command Enable Bit

After the command has been input, set bit 7 to 0 to start measurement.

STOP MEASUREMENT

Stops continuous measurement.

Word	Bits				Setting
	15 to 12	11 to 8	7 to 4	3 to 0	
+0	0000	-000	1000	----	Bit 4: Stops continuous measurement Bit 7: Command Enable Bit

SWITCH SCENE

Switches to a specified scene number.

Word	Bits				Setting
	15 to 12	11 to 8	7 to 4	3 to 0	
+0	0000	-000	1010	Scene number	Bit 5: Switch scene Bit 7: Command Enable Bit

Specify a number in the range 0 to 15 in binary format.

MODEL REGISTER

Re-registers the model based on the currently displayed image. (With through display, re-registers the model based on the measurement image input immediately before.) Only valid when the measurement method for the specified region is gray search or precise search. If other regions are specified, this command will be ignored.

Word	Bits				Setting
	15 to 12	11 to 8	7 to 4	3 to 0	
+0	0000	-000	1100	Region No.	Bit 6: Register model Bit 7: Command Enable Bit

Specify a number in the range 0 to 15 in binary format.

Two-camera Operation

If the camera mode is Two-camera Switching mode, since this command registers the image currently displayed, display the region for the desired Camera before execution. Use the **Up/Down** Console Keys to switch Camera images.

GATE TERMINAL OUTPUT CONTROL

When "any output" has been selected for GATE terminal control in the communications specifications setting menu, bit 11 will control the GATE terminal. If the GATE terminal is used for measurement output, the status of bit 11 will be ignored.

Word	Bits				Setting
	15 to 12	11 to 8	7 to 4	3 to 0	
+0	----	*-0-	----	----	Bit 11: GATE terminal control

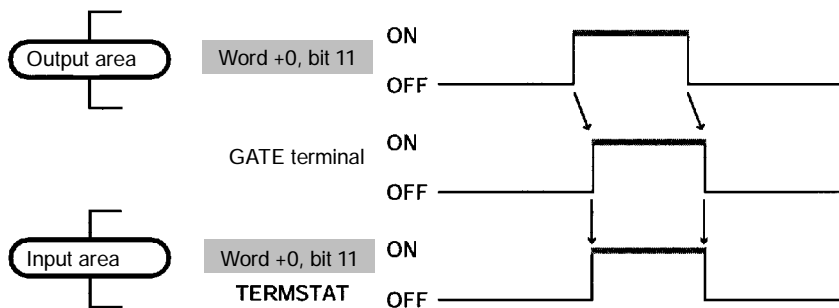

Area	Bits	Function
OUT	Bit 11	Controls the output from the user terminal (GATE terminal).
IN	TERMSTAT	The status of the GATE terminal will be reflected by the status of word +0, bit 11 of the input area (TERMSTAT). Therefore, the status of the GATE terminal can be obtained by monitoring this bit. There will be a time lag before changes in bit 11 of the output area are reflected in the GATE terminal due to DeviceNet communications delays and the status of the F150.

RESET

Resets the F150.

Word	Bits				Setting
	15 to 12	11 to 8	7 to 4	3 to 0	
+0	0000	-010	0000	0000	Bit 9: system reset

10-2-2 Expand Mode

Commands that Control F150 Operation

The following commands control F150 operation.

Command code	Function	Page
0010	Executes one measurement.	281
0011	Starts continuous measurement.	281
0012	Stops continuous measurement.	281
0020	Changes to a specified scene number.	282
0021	Increases the displayed scene number by one.	282
0022	Decreases the displayed scene number by one.	282
0040	Registers the model.	283
0066	Saves all data to flash memory.	283
0092	Resets the F150.	283

Commands that Read Measurement Results

The following commands read the results of the most recent measurement.

Command code	Function	Page
0080	Reads measurement results of the measurement region.	283
1210	Reads distances scrolled for position displacement compensation.	294
1220	Reads calculation results for judgement output expressions.	297
1221	Reads calculation results for data output expressions.	297

Commands that Read Current Settings

The following commands read settings such as evaluation criteria. F150 operation can be controlled from the Master while monitoring F150 settings.

Command code	Function	Page
0023	Reads number of currently displayed scene.	282
1070	Reads parameters for measurement region.	291
1110	Reads evaluation criteria for judgement output expressions.	292
1130	Reads light level of Intelligent Light Source.	293

Commands that Change F150 Settings

The following commands perform settings such as for evaluation criteria. F150 operation can be controlled from the Master while monitoring F150 settings.

Command code	Function	Page
1060	Sets parameters for measurement region.	287
1100	Sets evaluation criteria for judgement output expressions.	292
1120	Sets light level of Intelligent Light Source.	293

Commands that Control User Terminal (GATE) Output

Command code	Function	Page
1300	Turns user terminal (GATE) output ON/OFF.	298
1301	Reads the status of the user terminal (GATE).	299

Format

The word numbers given here are the offset values from the first word in the allocated area of the Master. "-" indicates that either 0 or 1 can be entered without affecting the setting. Commands are set in words +0 to +4. Word +0, bit 15 is a command trigger. Commands are executed when the status of this bit changes (0 ↔ 1).

Response

If the response output has been set to ON in the communications specifications settings menu, a response will be output from the F150 when a command has been completed. For commands that are given here without responses, the content of the

Input Format**Section 10-2**

response that is output in words +3 to +7 will be the same as for the commands in +0 to +4.

Example: for measurement (0010) commands.

Word	Bits				Setting
	15 to 12	11 to 8	7 to 4	3 to 0	
+0	*000	0000	0001	0000	Command code

All the bits in words +1 to +4 set to 0.

Response

Word	Bits				Setting
	15 to 12	11 to 8	7 to 4	3 to 0	
+3	*000	0000	0001	0000	Command code
+4	0000	0000	0000	0000	All 0
+5	0000	0000	0000	0000	
+6	0000	0000	0000	0000	
+7	0000	0000	0000	0000	

0010: ONE MEASUREMENT

Executes one measurement of the camera image.

Word	Bits				Setting
	15 to 12	11 to 8	7 to 4	3 to 0	
+0	*000	0000	0001	0000	Command code

Set all bits in words +1 to +4 to 0.

0011: CONTINUOUS MEASUREMENT

Starts continuous measurement.

To input other commands, input the STOP MEASUREMENT command. If other commands are input while continuous measurement is being executed, continuous measurement will be stopped temporarily and started up again once processing for the input command has been completed.

Word	Bits				Setting
	15 to 12	11 to 8	7 to 4	3 to 0	
+0	*000	0000	0001	0001	Command code

Set all bits in words +1 to +4 to 0.

0012: STOP MEASUREMENT

Stops continuous measurement.

Word	Bits				Setting
	15 to 12	11 to 8	7 to 4	3 to 0	
+0	*000	0000	0001	0010	Command code

Set all bits in words +1 to +4 to 0.

0020: SWITCH SCENE

Switches to a specified scene number.

Word	Bits				Setting
	15 to 12	11 to 8	7 to 4	3 to 0	
+0	*000	0000	0010	0000	Command code
+1	----	----	10's digit	1's digit	Scene No. (00 to 15)

Set all bits in words +2 to +4 to 0.

0021: INCREMENT SCENE

Increments the current scene number.

If the current scene number is 15, switches to scene 0.

Word	Bits				Setting
	15 to 12	11 to 8	7 to 4	3 to 0	
+0	*000	0000	0010	0001	Command code

Set all bits in words +1 to +4 to 0.

0022: DECREMENT SCENE

Decrements the current scene number.

If the current scene number is 0, switches to scene 15.

Word	Bits				Setting
	15 to 12	11 to 8	7 to 4	3 to 0	
+0	*000	0000	0010	0010	Command code

Set all bits in words +1 to +4 to 0.

0023: READ SCENE NUMBER

Reads the scene number of the image being displayed.

Word	Bits				Setting
	15 to 12	11 to 8	7 to 4	3 to 0	
+0	*000	0000	0010	0011	Command code

Set all bits in words +1 to +4 to 0.

Response

Word	Bits				Setting
	15 to 12	11 to 8	7 to 4	3 to 0	
+3	*000	0000	0001	0011	Command code
+4	0000	0000	0000	0000	All 0
+5	0000	0000	10's digit	1's digit	Scene No. (00 to 15)
+6	0000	0000	0000	0000	All 0
+7	0000	0000	0000	0000	All 0

0040: MODEL REGISTER

Re-registers the model based on the currently displayed image. (With through display, re-registers the model based on the measurement image input immediately before.) Only valid when the measurement method for the specified region is gray search or precise search. If any other regions are specified the command will be ignored.

Word	Bits				Setting
	15 to 12	11 to 8	7 to 4	3 to 0	
+0	*000	0000	0100	0000	Command code
+1	----	----	10's digit	1's digit	Region No. (00 to 15)

Set all bits in words +2 to +4 to 0.

Two-camera Operation

If the camera mode is Two-camera Switching mode, since this command registers the image currently displayed, display the region for the desired Camera before execution. Use the **Up/Down** Console Keys to switch Camera images.

0066: SAVE DATA

Saves all data to flash memory.

Word	Bits				Setting
	15 to 12	11 to 8	7 to 4	3 to 0	
+0	*000	0000	0110	0110	Command code

Set all bits in words +1 to +4 to 0.

0092: RESET

Resets the F150.

Word	Bits				Setting
	15 to 12	11 to 8	7 to 4	3 to 0	
+0	*000	0000	1001	0010	Command code

Set all bits in words +1 to +4 to 0.

0080: READ MEASUREMENT

Reads measurement results for the region measured last.

Word	Bits				Setting
	15 to 12	11 to 8	7 to 4	3 to 0	
+0	*000	0000	1000	0000	Command code
+1	10's digit of region number	1's digit of region number	10's digit of data type	1's digit of data type	Region No. (00 to 15) Data type (00 to 13)

Set all bits in words +2 to +4 to 0.

Response

Word	Bits				Setting
	15 to 12	11 to 8	7 to 4	3 to 0	
+3	*000	0000	1000	0000	Command code
+4	10's digit of region number	1's digit of region number	10's digit of data type	1's digit of data type	Region No. (00 to 15) Data type (00 to 13)
+5	1,000's digit	100's digit	10's digit	1's digit	Rightmost 4 digits of integral portion.
+6	Sign	1,000,000's digit	100,000's digit	10,000's digit	Leftmost 3 digits of integral portion and sign.
+7	0000	1st decimal	2nd decimal	3rd decimal	Decimal portion

Sign: Positive: 0000, Negative: 1111

Data Types

The data types that can be read will vary according to the measurement method for the specified region.

Binary Center of Gravity and Area, Binary Center of Gravity and Axis Angle

Parameter	Meaning
00	Judgement result (0: OK, -1: NG, -2: no measurement)
01	X coordinate of measured center of gravity
02	Y coordinate of measured center of gravity
03	X coordinate of reference center of gravity
04	Y coordinate of reference center of gravity
05	Displacement in X direction (measured X coordinate of center of gravity - reference X coordinate of center of gravity)
06	Displacement in Y direction (measured Y coordinate of center of gravity - reference Y coordinate of center of gravity)
07	Measured value for area
08	Reference value for area
09	Difference between reference and measured area
10	Inverted area (area of measurement region - measured area)
11	Measured axis angle
12	Reference axis angle
13	Axis displacement (measured axis angle - reference axis angle)

Note Parameters 11 to 13 are only used when measurement method is binary center of gravity and axis angle.

Gray Edge Position

Parameter	Meaning
00	Judgement result (0: OK, -1: NG, -2: no measurement)
01	Measured edge coordinate
02	Reference edge coordinate
03	Displacement (measured coordinate - reference coordinate)

Surface Defect

Parameter	Meaning
00	Judgement result (0: OK, -1: NG, -2: no measurement)
01	Measured defect
02	Maximum density value
03	Minimum density value

Density Averaging

Parameter	Meaning
00	Judgement result (0: OK, -1: NG, -2: no measurement)
01	Measured average density
02	Reference average density
03	Difference between measured average density and reference average density

Gray Search, Precise Search

Parameter	Meaning
00	Judgement result (0: OK, -1: NG, -2: no measurement)
01	Measured X coordinate
02	Measured Y coordinate
03	Reference X coordinate
04	Reference Y coordinate
05	Displacement in X direction (measured X coordinate - reference X coordinate)
06	Displacement in Y direction (measured Y coordinate - reference Y coordinate)
07	Correlation value

Edge Pitch

Parameter	Meaning
00	Judgement result (0: OK, -1: NG, -2: no measurement)
01	Number of detected objects
02	Average pitch
03	Maximum pitch
04	Minimum pitch
05	Average width
06	Maximum width
07	Minimum width

Relative Search

Parameter	Meaning
00	Judgement result (0: OK, -1: NG, -2: no measurement)
01	Measured X width
02	Measured Y width
03	Measured distance
04	Reference X width
05	Reference Y width
06	Reference distance
07	Difference in X widths (measured width - reference width)
08	Difference in Y widths (measured width - reference width)
09	Difference in distances (measured distance - reference distance)
10	Correlation with model 0
11	Correlation with model 1

1060: SET PARAMETER

Sets parameters for measurement regions.

Word	Bits				Setting
	15 to 12	11 to 8	7 to 4	3 to 0	
+0	*001	0000	0110	0000	Command code
+1	10's digit of region number	1's digit of region number	10's digit of data type	1's digit of data type	Region No. (00 to 15) Data type (00 to 14)
+2	1,000's digit	100's digit	10's digit	1's digit	Rightmost 4 digits of setting data.
+3	Sign	1,000,000's digit	100,000's digit	10,000's digit	Leftmost 3 digits of setting data and sign.
+4	0000	1st decimal	2nd decimal	3rd decimal	Decimal portion of setting data.

Data Types

The data types that can be set will vary according to the measurement method for the specified region.

Binary Center of Gravity and Area, Binary Center of Gravity and Axis Angle

Parameter	Meaning
00	Upper limit of X coordinate of center of gravity (-9,999.999 to 9,999.999)
01	Lower limit of X coordinate of center of gravity (-9,999.999 to 9,999.999)
02	Upper limit of Y coordinate of center of gravity (-9,999.999 to 9,999.999)
03	Lower limit of Y coordinate of center of gravity (-9,999.999 to 9,999.999)
04	Upper limit of area (0 to 9,999,999.999)
05	Lower limit of area (0 to 9,999,999.999)
06	Upper-left X coordinate of region (0 to 511)
07	Upper-left Y coordinate of region (0 to 483)
08	Lower-right X coordinate of region (0 to 511)
09	Lower-right Y coordinate of region (0 to 483)
10	Upper limit of binary level (0 to 255)
11	Lower limit of binary level (0 to 255)
12	Binary level inversion (0: not inverted, 1: inverted)
13	Upper limit of axis angle (-180.000 to 180.000)
14	Lower limit of axis angle (-180.000 to 180.000)

Note Parameters 13 and 14 are only used when the measurement method is binary center of gravity and axis angle.

Gray Edge Position

Parameter	Meaning
00	Upper limit of position (-9,999.999 to 9,999.999)
01	Lower limit of position (-9,999.999 to 9,999.999)
02	Upper-left X coordinate of region (0 to 511)
03	Upper-left Y coordinate of region (0 to 483)
04	Lower-right X coordinate of region (0 to 511)
05	Lower-right Y coordinate of region (0 to 483)
06	Edge search direction (↑: 0, ↓: 1, →: 2, ←: 3)
07	Edge color (Light → Dark: 0, Dark → Light: 1)
08	Level (0 to 100)

Gray Search, Precise Search

Parameter	Meaning
00	Upper limit of X coordinate (-9,999.999 to 9,999.999)
01	Lower limit of X coordinate (-9,999.999 to 9,999.999)
02	Upper limit of Y coordinate (-9,999.999 to 9,999.999)
03	Lower limit of Y coordinate (-9,999.999 to 9,999.999)
04	Upper limit of correlation value (0 to 100)
05	Lower limit of correlation value (0 to 100)
06	Upper-left X coordinate of search region (0 to 511)
07	Upper-left Y coordinate of search region (0 to 483)
08	Lower-right X coordinate of search region (0 to 511)
09	Lower-right Y coordinate of search region (0 to 483)
10	X coordinate of reference position (0 to 511)
11	Y coordinate of reference position (0 to 483)
12	Search speed (0: LOW → 1 → 2 → 3 → 4: HIGH)

Edge Pitch

Parameter	Meaning
00	Upper limit of number of objects (0 to 255)
01	Lower limit of number of objects (0 to 255)
02	Upper limit of pitch (0 to 9,999.999)
03	Lower limit of pitch (0 to 9,999.999)
04	Upper limit of width (0 to 9,999.999)
05	Lower limit of width (0 to 9,999.999)
06	Upper-left X coordinate of region (0 to 511)
07	Upper-left Y coordinate of region (0 to 483)
08	Lower-right X coordinate of region (0 to 511)
09	Lower-right Y coordinate of region (0 to 483)
10	Counted object color (White: 0, Black: 1)
11	Edge level (0 to 100)
12	Minimum level (0 to 255)

Density Averaging

Parameter	Meaning
00	Upper limit of average density (0.000 to 255.000)
01	Lower limit of average density (0.000 to 255.000)
02	Upper-left X coordinate of region (0 to 511)
03	Upper-left Y coordinate of region (0 to 483)
04	Lower-right X coordinate of region (0 to 511)
05	Lower-right Y coordinate of region (0 to 483)

Relative Search

Parameter	Meaning
00	Upper limit of width X (-9999.999 to 9999.999)
01	Lower limit of width X (-9999.999 to 9999.999)
02	Upper limit of width Y (-9999.999 to 9999.999)
03	Lower limit of width Y (-9999.999 to 9999.999)
04	Upper limit of distance (0 to 9999.999)
05	Lower limit of distance (0 to 9999.999)
06	Upper limit of correlation with model 0 (0 to 100)
07	Lower limit of correlation with model 0 (0 to 100)
08	Upper limit of correlation with model 1 (0 to 100)
09	Lower limit of correlation with model 1 (0 to 100)
10	Upper-left X coordinate of search region for model 0 (0 to 511)
11	Upper-left Y coordinate of search region for model 0 (0 to 483)
12	Lower-right X coordinate of search region for model 0 (0 to 511)
13	Lower-right Y coordinate of search region for model 0 (0 to 483)
14	Upper-left X coordinate of search region for model 1 (0 to 511)
15	Upper-left Y coordinate of search region for model 1 (0 to 483)
16	Lower-right X coordinate of search region for model 1 (0 to 511)
17	Lower-right Y coordinate of search region for model 1 (0 to 483)
18	X coordinate of reference position for model 0 (0 to 511)
19	Y coordinate of reference position for model 0 (0 to 483)
20	X coordinate of reference position for model 1 (0 to 511)
21	Y coordinate of reference position for model 1 (0 to 483)
22	Search speed (0: LOW → 1 → 2 → 3 → 4: HIGH)

Surface Defect

Parameter	Meaning
00	Defect (0 to 255)
01	Upper limit of density value (0 to 255)
02	Lower limit of density value (0 to 255)
03	Element size (4 to 80)
04	Compare pitch (1 to 6)
05 to 10	See note

Note The meanings of parameters 5 to 10 vary according to the shape of the region.

Parameter	Box	Line	Circumference	Arc
05	Upper-left X coordinate of region (0 to 511)	X coordinate of start point (0 to 511)	X coordinate of center (0 to 511)	X coordinate of center (0 to 511)
06	Upper-left Y coordinate of region (0 to 483)	Y coordinate of start point (0 to 483)	Y coordinate of center (0 to 483)	Y coordinate of center (0 to 483)
07	Lower-right X coordinate of region (0 to 511)	X coordinate of end point (0 to 511)	Radius (1 to 512)	Radius (1 to 512)
08	Lower-right Y coordinate of region (0 to 483)	Y coordinate of end point (0 to 483)	Width (1 to 64)	Width (1 to 64)
09	---	Width (1 to 64)	---	Start angle (-180.00 to 180.00)
10	---	---	---	End angle (-180.00 to 180.00)

1070: READ PARAMETER

Reads parameters for measurement regions. The data types are the same as for command 1060. Refer to the parameter listed above.

Word	Bits				Setting
	15 to 12	11 to 8	7 to 4	3 to 0	
+0	*001	0000	0111	0000	Command code
+1	10's digit of region number	1's digit of region number	10's digit of data type	1's digit of data type	Region No. (00 to 15) Data type (00 to 14)

Set all bits in words +2 to +4 to 0.

Response

Word	Bits				Setting
	15 to 12	11 to 8	7 to 4	3 to 0	
+3	*001	0000	0111	0000	Command code
+4	10's digit of region number	1's digit of region number	10's digit of data type	1's digit of data type	Region No. (00 to 15) Data type (00 to 14)
+5	1,000's digit	100's digit	10's digit	1's digit	Rightmost 3 digits of integral portion.
+6	Sign	1,000,000's digit	100,000's digit	10,000's digit	Leftmost 3 digits of integral portion and sign.
+7	0000	1st decimal	2nd decimal	3rd decimal	Decimal portion

Sign: Positive: 0000, Negative: 1111

1100: SET JUDGEMENT OUTPUT EXPRESSION CRITERIA

Sets evaluation criteria for judgement output expressions.

Word	Bits				Setting
	15 to 12	11 to 8	7 to 4	3 to 0	
+0	*001	0001	0000	0000	Command code
+1	0000	Type	10's digit	1's digit	Judgement number (00 to 15) and type
+2	1,000's digit	100's digit	10's digit	1's digit	Rightmost 4 digits of integral portion
+3	Sign	1,000,000's digit	100,000's digit	10,000's digit	Leftmost 3 digits of integral portion and sign
+4	0000	1st decimal	2nd decimal	3rd decimal	Decimal portion

Type: Upper limit: 0000, Lower limit: 0001

Sign: Positive: 0000, Negative: 1111

1110: READ JUDGEMENT OUTPUT EXPRESSION CRITERIA

Reads evaluation criteria for judgement output expressions.

Word	Bits				Setting
	15 to 12	11 to 8	7 to 4	3 to 0	
+0	*001	0001	0001	0000	Command code
+1	0000	Type	10's digit of judgement number	1's digit of judgement number	Judgement number (00 to 15) and type

Type: Upper limit: 0000, Lower limit: 0001

Set all bits in words +2 to +4 to 0.

Response

Word	Bits				Setting
	15 to 12	11 to 8	7 to 4	3 to 0	
+3	*001	0001	0001	0000	Command code
+4	0000	Type	10's digit of judgement number	1's digit of judgement number	Judgement number (00 to 15) and type Write Verification Flag
+5	1,000's digit	100's digit	10's digit	1's digit	Rightmost 4 digits of integral portion
+6	Sign	1,000,000's digit	100,000's digit	10,000's digit	Leftmost 3 digits of integral portion and sign.
+7	0000	1st decimal	2nd decimal	3rd decimal	Decimal portion

Sign: Positive: 0000, Negative: 1111

1120: SET LIGHT LEVEL

Sets the light level for the Intelligent Light Source.

Word	Bits				Setting
	15 to 12	11 to 8	7 to 4	3 to 0	
+0	*001	0001	0010	0000	Command code
+1	0000	0000	0000	Camera number	Camera number (0 to 1)
+2	Light level for section B	Light level for section C	Light level for section D	Light level for section E	Light level for each section (0 to 7; 0 = unlit)
+3	0000	0000	0000	Light level for section A	
+4	0000	Light level for section F	Light level for section G	Light level for section H	

F150-LTC20



F to H always set to 0

F150-LTC50

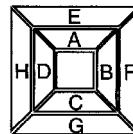

1130: READ LIGHT LEVEL

Reads the light level for the Intelligent Light Source. For details of the positions of the sections, refer to 1120: SET LIGHT LEVEL.

Input Format**Section 10-2**

Word	Bits				Setting
	15 to 12	11 to 8	7 to 4	3 to 0	
+0	*001	0001	0011	0000	Command code
+1	0000	0000	0000	Camera number	Camera number (0 or 1)

Response

Word	Bits				Setting
	15 to 12	11 to 8	7 to 4	3 to 0	
+0	*001	0001	0011	0000	Command code
+1	Light level for section B	Light level for section C	Light level for section D	Light level for section E	Light level for each section (0 to 7; 0 = unlit)
+2	0000	0000	0000	Light level for section A	
+3	0000	Light level for section F	Light level for section G	Light level for section H	

1210: READ POSITION

Reads measurement values related to position displacement compensation for most recent measurement.

Word	Bits				Setting
	15 to 12	11 to 8	7 to 4	3 to 0	
+0	*001	0010	0001	0000	Command code
+1	10's digit of region number	1's digit of region number	10's digit of data type	1's digit of data type	Region No. (0 to 1; to read displacement: 2) Data type (00 to 13)

Set all bits in words +2 to +4 to 0.

Two-camera Operation

If two cameras are used, specify 0 or 1 (for **Position compensation 0**), or 10 or 11 (for **Position compensation 1**) for the region number. To read the displacement, specify 2 (for **Position compensation 0**) or 12 (for **Position compensation 1**).

Response

Word	Bits				Setting
	15 to 12	11 to 8	7 to 4	3 to 0	
+3	*001	0010	0001	0000	Command code
+4	0000	Region number	10's digit of data type	1's digit of data type	Region No. (0 to 1; to read displacement: 2) Data type (00 to 13)
+5	1,000's digit	100's digit	10's digit	1's digit	Rightmost 4 digits of integral portion
+6	Sign	1,000,000's digit	100,000's digit	10,000's digit	Leftmost 3 digits of integral portion and sign
+7	0000	1st decimal	2nd decimal	3rd decimal	Decimal portion

Sign: Positive: 0000, Negative: 1111

Data Types

The data types that can be read will vary according to the measurement method for the specified region.

Gray Edge Position

Parameter	Meaning
00	Judgement result (0: OK, -1: NG, -2: no measurement)
01	Measured edge coordinate
02	Reference edge coordinate
03	Displacement (measured coordinate - reference coordinate)

Position Displacement

Parameter	Meaning
00	Displacement in X direction (reference X coordinate - measured X coordinate)
01	Displacement in Y direction (reference Y coordinate - measured Y coordinate)
02	Angle displacement (reference angle - measured angle)

Binary Center of Gravity and Area, Binary Center of Gravity and Axis Angle

Parameter	Meaning
00	Judgement result (0: OK, -1: NG, -2: no measurement)
01	X coordinate of measured center of gravity
02	Y coordinate of measured center of gravity
03	X coordinate of reference center of gravity
04	Y coordinate of reference center of gravity
05	Displacement in X direction (measured X coordinate of center of gravity - reference X coordinate of center of gravity)
06	Displacement in Y direction (measured Y coordinate of center of gravity - reference Y coordinate of center of gravity)
07	Measured value for area
08	Reference value for area
09	Difference between reference and measured area
10	Inverted area (area of measurement region - measured area)
11	Measured axis angle
12	Reference axis angle
13	Axis displacement (measured axis angle - reference axis angle)

Note Parameters 11 to 13 are only used when measurement method is binary center of gravity and axis angle.

Gray Search

Parameter	Meaning
00	Judgement result (0: OK, -1: NG, -2: no measurement)
01	Measured X coordinate
02	Measured Y coordinate
03	Reference X coordinate
04	Reference Y coordinate
05	Displacement in X direction (measured X coordinate - reference X coordinate)
06	Displacement in Y direction (measured Y coordinate - reference Y coordinate)
07	Correlation value

Input Format**Section 10-2****1220: READ JUDGEMENT OUTPUT EXPRESSION RESULT**

Reads calculation results of judgement output expressions for the most recent measurement.

Word	Bits				Setting
	15 to 12	11 to 8	7 to 4	3 to 0	
+0	*001	0010	0010	0000	Command code
+1	0000	0000	10's digit	1's digit	Judgement number (00 to 15)

Set all bits in words +2 to +4 to 0.

Response

Word	Bits				Setting
	15 to 12	11 to 8	7 to 4	3 to 0	
+3	*001	0010	0010	0000	Command code
+4	0000	0000	10's digit	1's digit	Judgement number (00 to 15)
+5	1,000's digit	100's digit	10's digit	1's digit	Rightmost 4 digits of integral portion of calculation result
+6	Sign	1,000,000's digit	100,000's digit	10,000's digit	Leftmost 3 digits of integral portion of calculation result and sign
+7	0000	1st decimal	2nd decimal	3rd decimal	Decimal portion

Sign: Positive: 0000, Negative: 1111

1221: READ DATA OUTPUT EXPRESSION RESULT

Reads calculation results of data output expressions for the most recent measurement.

Word	Bits				Setting
	15 to 12	11 to 8	7 to 4	3 to 0	
+0	*001	0010	0010	0001	Command code
+1	0000	0000	0000	1's digit	Data number (0 to 7)

Set all bits in words +2 to +4 to 0.

Response

Word	Bits				Setting
	15 to 12	11 to 8	7 to 4	3 to 0	
+3	*001	0010	0010	0001	Command code
+4	0000	0000	0000	1's digit	Data number (0 to 7)
+5	1,000's digit	100's digit	10's digit	1's digit	Rightmost 4 digits of integral portion of calculation result
+6	Sign	1,000,000's digit	100,000's digit	10,000's digit	Leftmost 3 digits of integral portion of calculation result and sign
+7	0000	1st decimal	2nd decimal	3rd decimal	Decimal portion

Sign: Positive: 0000, Negative: 1111

1300: GATE TERMINAL OUTPUT CONTROL

Changes the output of the user terminal (GATE terminal). This setting is only valid if GATE terminal control has been set to user output in the communications specifications setting menu.

Word	Bits				Setting
	15 to 12	11 to 8	7 to 4	3 to 0	
+0	*001	0011	0000	0000	Command code
+1	0000	0000	0000	ON/OFF	Terminal output control

Set all bits in words +2 to +4 to 0.

ON/OFF: ON (0001), OFF (0000)

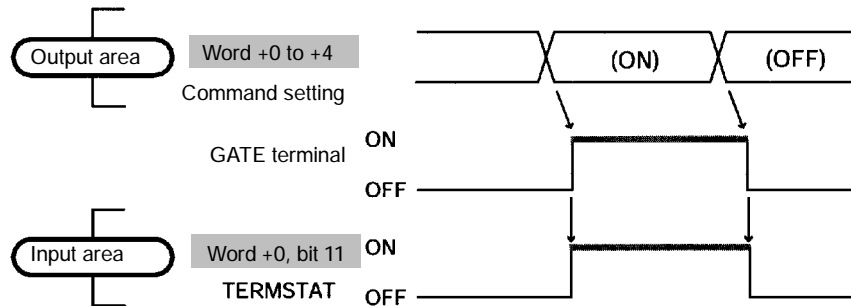

Area	Bits	Function
OUT	Word +0 to +1	Sets the command (ON/OFF).
IN	TERMSTAT	The status of the GATE terminal will be reflected by the status of word +0, bit 11 of the input area (TERMSTAT). Therefore, the status of the GATE terminal can be monitored with this bit. There will be a time lag before changes in bit 11 of the output area due to DeviceNet communications delays and the status of the F150.

1301: READ GATE TERMINAL STATUS

Reads the status of the user terminal (GATE terminal). This setting is only valid if GATE terminal control has been set to user output in the communications specifications setting menu.

Word	Bits				Setting
	15 to 12	11 to 8	7 to 4	3 to 0	
+0	*001	0011	0000	0001	Command code

Set all bits in words +1 to +4 to 0.

Response

Word	Bits				Setting
	15 to 12	11 to 8	7 to 4	3 to 0	
+3	*001	0011	0000	0001	Command code
+4	0000	0000	0000	0000	All 0
+5	0000	0000	0000	ON/OFF	ON/OFF status of terminal
+6	0000	0000	0000	0000	All 0
+7	0000	0000	0000	0000	All 0

ON/OFF: ON (0001), OFF (0000)

10-3 Output Format

The following explains the contents of output from the F150 to the input area of the Programmable Controller. Data output and response output settings can be made in the communications specifications setting menu. The number of bytes will vary according to these settings as shown below.

Data Output: OFF; Response Output: OFF

Word	Bits				Bytes
	15 to 12	11 to 8	7 to 4	3 to 0	
+0	Control output				6 bytes
+1	Judgement output				
+2	F150 status output				

Output Format**Section 10-3****Data Output: OFF; Response Output: ON**

Word	Bits				Bytes
	15 to 12	11 to 8	7 to 4	3 to 0	
+0	Control output				16 bytes
+1	Judgement output				
+2	F150 status output				
+3	Expand command response output				
+4					
+5					
+6					
+7					

Data Output: BCD/Binary; Response Output: OFF

Word	Bits				Bytes
	15 to 12	11 to 8	7 to 4	3 to 0	
+0	Control output				54 bytes
+1	Judgement output				
+2	F150 status output				
+3 to +26	Data output (BCD/binary)				

Data Output: ON; Response Output: ON

Word	Bits				Bytes
	15 to 12	11 to 8	7 to 4	3 to 0	
+0	Control output				64 bytes
+1	Judgement output				
+2	F150 status output				
+3	Expand command response output				
+4					
+5					
+6					
+7					
+8 to +31	Data output (BCD/binary)				

10-3-1 Control Output (Word +0)

Bits	Flag	Function
0	ERROR	Turns ON if an error is generated during F150 processing. Turns ON/OFF in synchronization with the ERR terminal on the terminal block.
1	RUN	ON while the F150 is in Run mode. Turns ON/OFF in synchronization with the RUN terminal on the terminal block.
2	BUSY	Indicates that the F150 is executing a command from CompoBus/D. Do not input a command while the BUSY Flag is ON. The currently executed command or the input command will not be executed properly. When commands are from RS-232C, or when using a STEP signal from a terminal board, this output will not turn ON. When inputting in this way, use the BUSY signal on the terminal board.
3	Empty	(Always 0)
4	OR	Outputs an overall judgement when a measurement command has been executed. If there is one NG in the specified measurement region or the output expressions, the overall judgement will be NG. Select whether to turn ON this output for OK or NG in the output polarity setting in SYS/Communications/Terminal block . (The default setting is ON for NG.) → p. 182
5 to 7	Empty	(Always 0)
8	JDGFLG	Alternates between 0 and 1 to indicate that judgement output has been refreshed.
9	DATAFLG	Alternates between 0 and 1 to indicate that data output has been refreshed.
10	CMDFLG (see note)	Alternates between 0 and 1 to indicate that expand command response output has been refreshed. Do not change the contents of an expand command until this flag has changed status. By comparing the Expand Command Bit and the Response Output Bit when the flag changes status, it is possible to verify whether the input command and the executed command correspond.
11	TERMSTAT	Indicates the current status of the GATE terminal. Only output when the GATE terminal control is set to any output.
12	CMDSTAT (see note)	Indicates expand command errors (wrong format, etc.). When an error occurs, this flag turns ON and expand command response is not output. The CMDFLG will change accordingly.
13 to 15	Empty	(Always 0)

Note CMDFLG and CMDSTAT are only valid when the input mode is Expand mode.

10-3-2 Judgement Output (+1)

When measurement commands are executed, the judgements and calculation results set in **Expression/Judge** are output. Select whether a bit is turned ON by an OK or an NG judgement, in the output polarity setting in **SYS/Communications/Terminal block**. (The default setting is for the bit to turn ON for an NG judgement.) → p. 182

Bits	Allocation
0	Judgement output 0
1	Judgement output 1
2	Judgement output 2
3	Judgement output 3
4	Judgement output 4
5	Judgement output 5
6	Judgement output 6
7	Judgement output 7
8	Judgement output 8
9	Judgement output 9
10	Judgement output 10
11	Judgement output 11
12	Judgement output 12
13	Judgement output 13
14	Judgement output 14
15	Judgement output 15

10-3-3 F150 Status Output (+2)

Bits	Allocation
0 to 3	Number of currently displayed scene (refreshed when the Switch Scene command is executed)
4 to 7	Empty (always 0)
8 (see note)	Continuous Measurement Start Flag
9 (see note)	Continuous Measurement Stop Flag
10 (see note)	Switch Scene Completed Flag
11 (see note)	Model Register Completed Flag
12 (see note)	One Measurement Completed Flag
13 to 15	Empty (always 0)

Note Bits 8 to 12 above are only valid when the input mode is Basic mode.

When a command has been executed, the corresponding flag will turn ON. Wait for the flag to turn ON, and turn OFF the command. When the command is turned OFF, the corresponding flag will also turn OFF. For details refer to the relevant timing chart.

10-3-4 Expand Command Response Output (+3 to 7)

After an expand command has been executed, a response is output. For details of responses to given commands refer to *10-2 Input Format*.

Since these words are allocated for expand command output, if the input mode is Basic mode, the output will always be 0. Accordingly, if the input mode is set to Basic mode, turn the response output OFF.

Example: 0023: Read Scene Number

Word	Bits				Setting
	15 to 12	11 to 8	7 to 4	3 to 0	
+0	*000	0000	0010	0011	Command code

Set words +1 to +4 OFF.

Response

Word	Bits				Setting
	15 to 12	11 to 8	7 to 4	3 to 0	
+3	*000	0000	0010	0011	Command code
+4	0000	0000	0000	0000	All 0
+5	0000	0000	10's digit	1's digit	Scene number (00 to 15)
+6	0000	0000	0000	0000	All 0
+7	0000	0000	0000	0000	All 0

Note For commands that are given here without responses, the content of the response that is output in words +3 to +7 will be the same as for the commands in +0 to +4.

10-3-5 Data Output in BCD or Binary (+3 to 26 or +8 to 31)

When measurement commands are executed, the results of calculations set in **Expression/Data** are output. The range for output values is -9,999,999.999 to 9,999,999.999 (after calibration).

If expand command response output is OFF, the results are output to words +3 to +26, and if it is ON, the results are output to words +8 to +31.

BCD Code

Word	Word	Bits				Setting
		15 to 12	11 to 8	7 to 4	3 to 0	
+3	+8	1,000's digit	100's digit	10's digit	1's digit	Rightmost 4 digits of integral portion of data 0 (decimal)
+4	+9	Sign	1,000,000's digit	100,000's digit	10,000's digit	Leftmost 3 digits of of integral portion of data 0 (decimal) and sign
+5	+10	0000	1st decimal	2nd decimal	3rd decimal	Decimal portion of data 0 (decimal)
+6	+11	1,000's digit	100's digit	10's digit	1's digit	Rightmost 4 digits of integral portion of data 1 (decimal)
+7	+12	Sign	1,000,000's digit	100,000's digit	10,000's digit	Leftmost 3 digits of of integral portion of data 1 (decimal) and sign
+8	+13	0000	1st decimal	2nd decimal	3rd decimal	Decimal portion of data 1 (decimal)
to	to					
$3 + (3 \times n) + 0$	$8 + (3 \times n) + 0$	1,000's digit	100's digit	10's digit	1's digit	Rightmost 4 digits of integral portion of data n (decimal)
$3 + (3 \times n) + 1$	$8 + (3 \times n) + 1$	Sign	1,000,000's digit	100,000's digit	10,000's digit	Leftmost 3 digits of of integral portion of data n (decimal) and sign
$3 + (3 \times n) + 2$	$8 + (3 \times n) + 2$	0000	1st decimal	2nd decimal	3rd decimal	Decimal portion of data n (decimal)
to	to					
+24	+29	1,000's digit	100's digit	10's digit	1's digit	Rightmost 4 digits of integral portion of data 7 (decimal)
+25	+30	Sign	1,000,000's digit	100,000's digit	10,000's digit	Leftmost 3 digits of of integral portion of data 7 (decimal) and sign
+26	+31	0000	1st decimal	2nd decimal	3rd decimal	Decimal portion of data 7 (decimal)

Sign: Positive: 0000, Negative: 1111

Values for output numbers which are not set will be 0.

Output Format**Section 10-3****Binary Code**

The binary 2's complement of the calculation results after multiplication by a factor of 1,000 are output. The output values are restricted to the range of values whose 2's complement can be expressed in 6 bytes.

Word	Word	Bits				Setting
		15 to 12	11 to 8	7 to 4	3 to 0	
+3	+8	Binary data				First 2 bytes of data 0.
+4	+9	Binary data				Middle 2 bytes of data 0.
+5	+10	Binary data				Last 2 bytes of data 0.
+6	+11	Binary data				First 2 bytes of data 1.
+7	+12	Binary data				Middle 2 bytes of data 1.
+8	+13	Binary data				Last 2 bytes of data 1.
to	to					
$3 + (3 \times n) + 0$	$8 + (3 \times n) + 0$	Binary data				First 2 bytes of data n.
$3 + (3 \times n) + 1$	$8 + (3 \times n) + 1$	Binary data				Middle 2 bytes of data n.
$3 + (3 \times n) + 2$	$8 + (3 \times n) + 2$	Binary data				Last 2 bytes of data n.
to	to					
+24	+29	Binary data				First 2 bytes of data 10.
+25	+30	Binary data				Middle 2 bytes of data 10.
+26	+31	Binary data				Last 2 bytes of data 10.

Values for output numbers which are not set will be 0.

10-4 Timing Charts

The meanings of the arrows and dotted lines used in this section are as follows:

↓	The F150 is controlled automatically according to the status of the bit at the base of the arrow.
↓	Perform ON/OFF control according to the status of the bit at the base of the arrow.
- - - - -	Dotted lines indicate optional output. By deselecting outputs, the number of bytes can be reduced.

10-4-1 Basic Mode

One Measurement

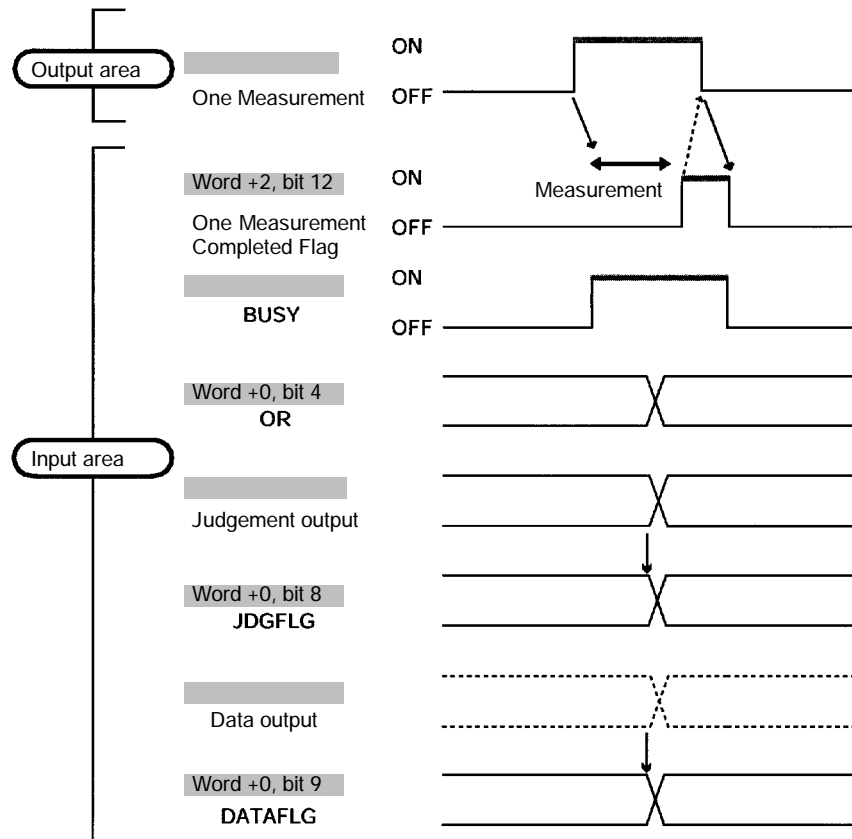

Note There is no expand command response output and the words allocated for this output will always be 0. The setting for response

output in the Communications Specifications Screen should be turned OFF before inputting a command.

Continuous Measurement

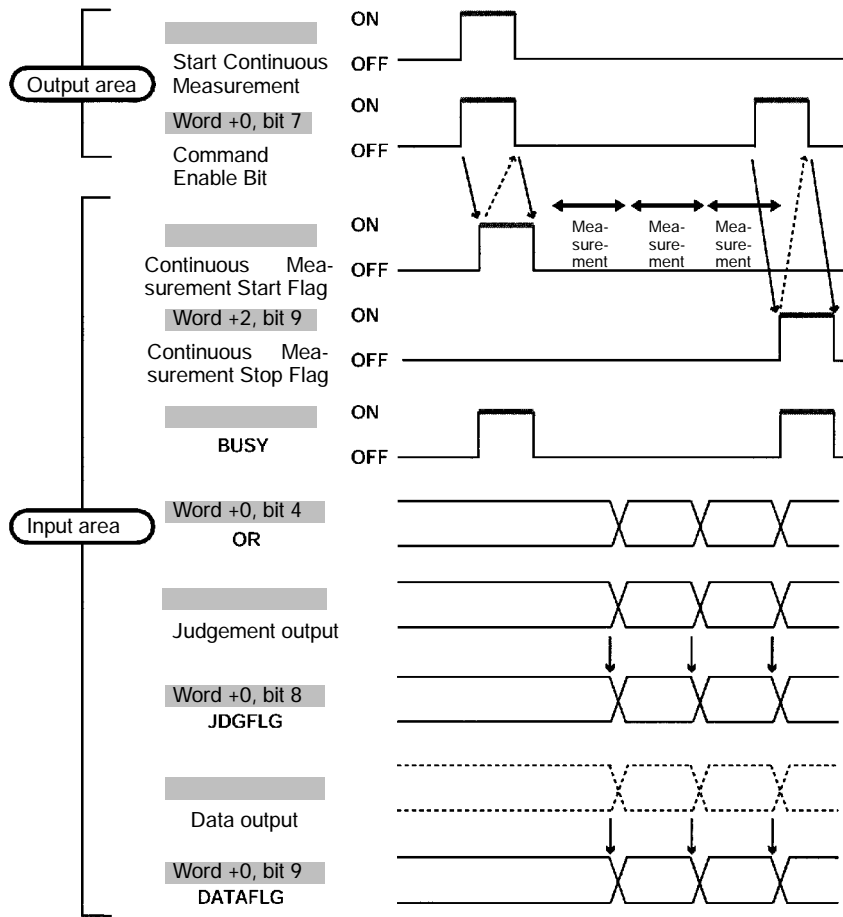

Note There is no expand command response output and the words allocated for this output will always be 0. The setting for response output in the Communications Specifications Screen should be turned OFF before inputting a command.

Switching Scenes

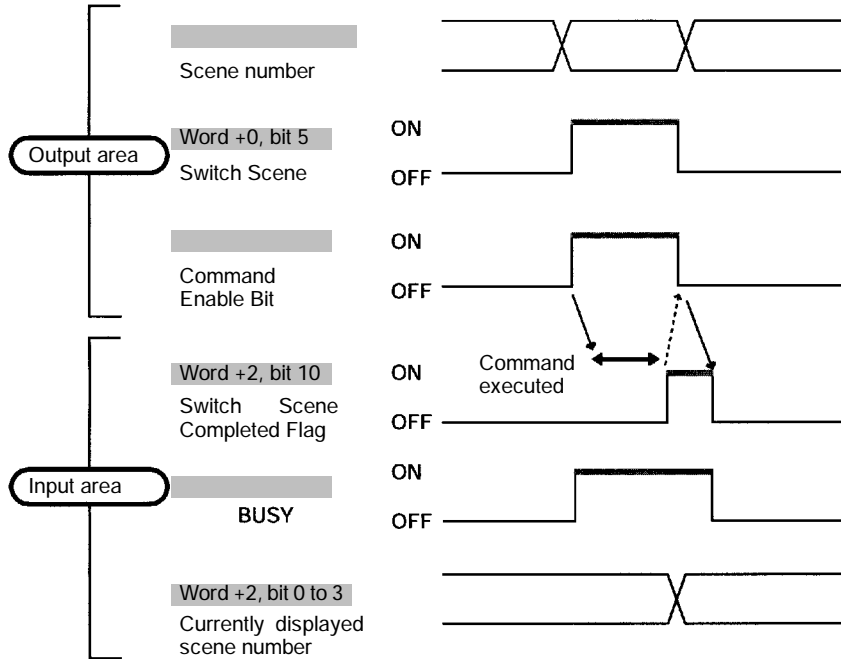

Re-registering the Model

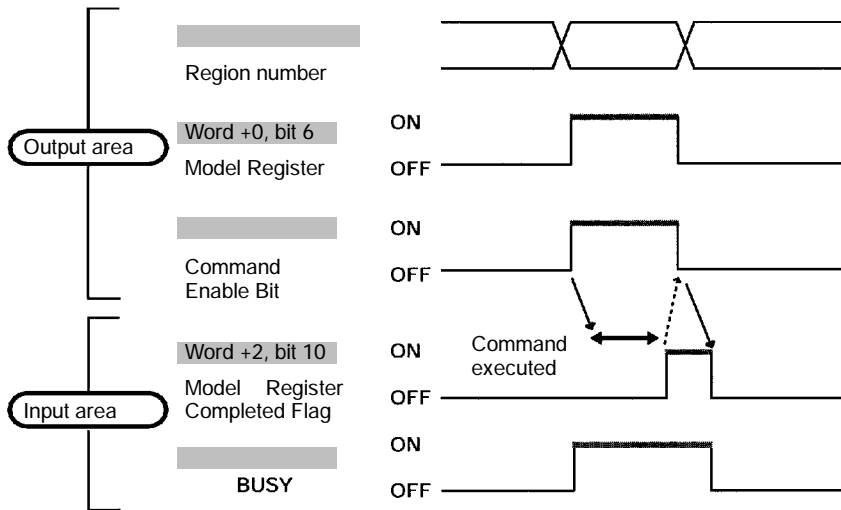

10-4-2 Expand Mode

One Measurement (0010)

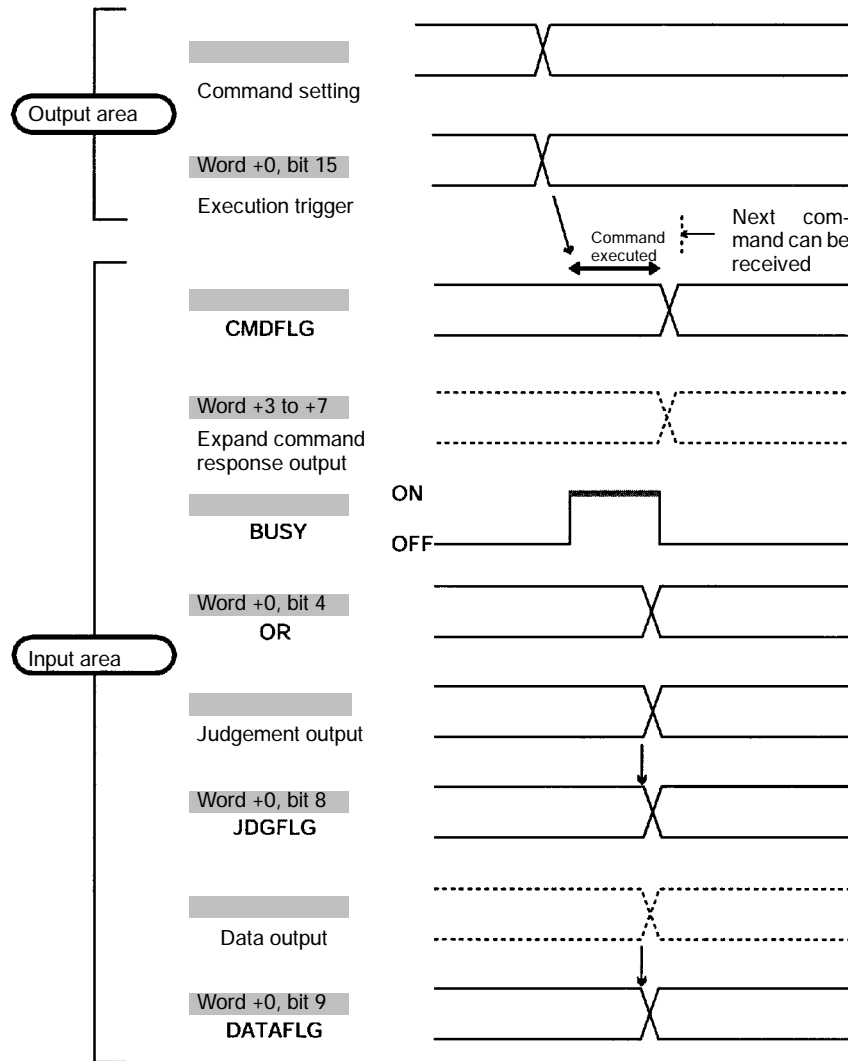

Note Word +2 of Input Area (F150 Status Output)
 The first 4 bits of this word are used to output the number of the currently displayed scene. All other bits are for responses in Basic mode, and therefore will always be output as 0.

Continuous Measurement (Start: 0011; Stop: 0012)

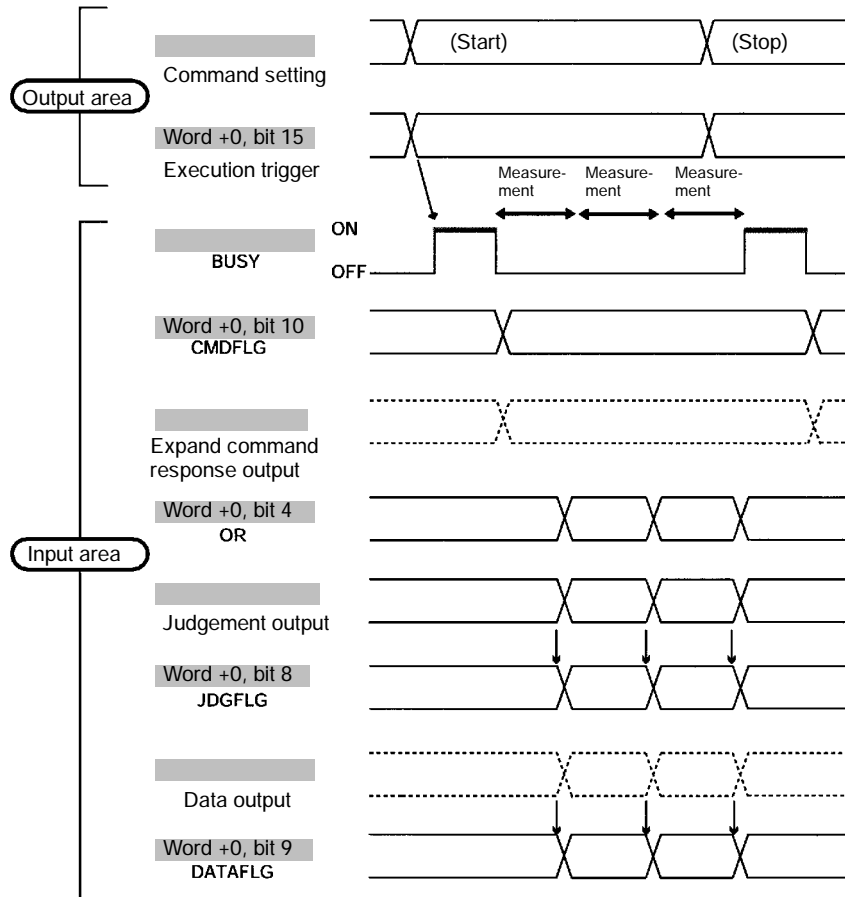

Note Word +2 of Input Area (F150 Status Output)

The first 4 bits of this word are used to output the number of the currently displayed scene. All other bits are for responses in Basic mode, and therefore will always be output as 0.

Commands for Reading Values (e.g. 0023 READ SCENE NUMBER)

Set the response output setting in the communications specifications settings menu to ON.

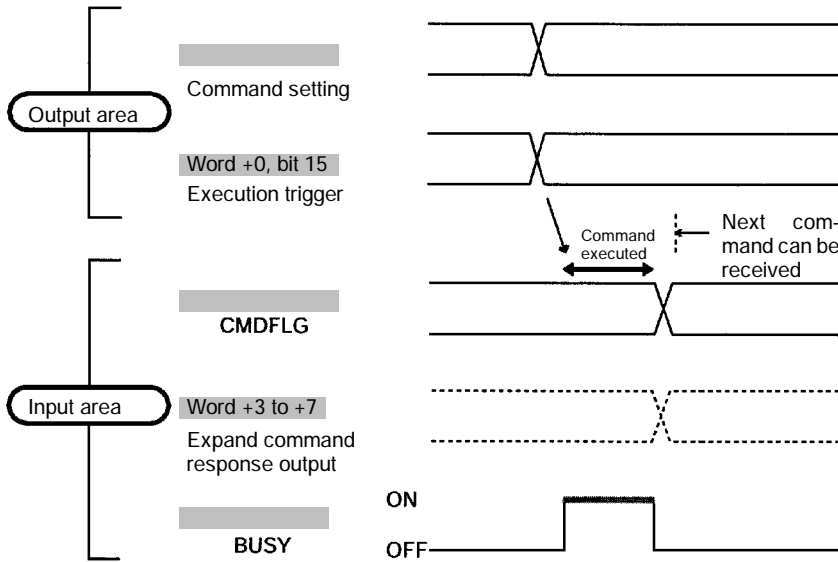

Note Word +2 of Input Area (F150 Status Output)

The first 4 bits of this word are used to output the number of the currently displayed scene. All other bits are for responses in Basic mode, and therefore will always be output as 0.

Commands that Control F150 Operation (e.g. 0020 SWITCH SCENE)

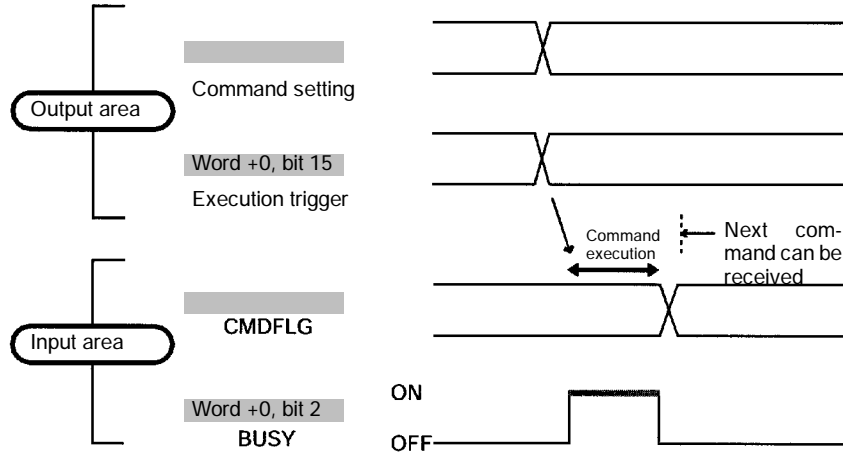

Note Word +2 of Input Area (F150 Status Output)

The first 4 bits of this word are used to output the number of the currently displayed scene. All other bits are for responses in Basic mode, and therefore will always be output as 0.

10-5 Allocation Charts

This section gives lists of allocations for the input and output area of the Programmable Controller. For details refer to *Input Format* and *Output Format*.

Output AreaFor details refer to *Input Format*. → p. 276**Basic Mode**

Bits	Word +0
0	Scene number/region number
1	
2	
3	
4	Continuous Measurement
5	Scene Switch
6	Model Register
7	Enable Bit
8	One Measurement
9	Reset
10	Empty
11	GATE Terminal
12	Empty
13	
14	
15	

Expand Mode

Bits	Word +0	Word +1	Word +2	Word +3	Word +4
0	Command code	Parameter			
1					
2					
3					
4					
5					
6					
7					
8					
9					
10					
11					
12					
13					
14					
15	Execution trigger				

Input AreaFor details refer to *Output Format*. → p. 299

Bits	Word +0	Word +1	Word +2	Word +3 to Word +7	Word +8 to Word +31
0	ERROR	Judgement for expression set in Expression/Judge . (Judgement 0: bit 0: ...Judgement 15: bit 15)	Number of currently displayed scene	Expand command responses (see note 1)	Calculation results for expressions set in Expression/Judge . (If the expand command responses are all set to OFF, these calculation results will be output to words +3 to +26.)
1	RUN				
2	BUSY				
3	Empty				
4	OR		Empty		
5	Empty				
6					
7					
8	JDGFLG		Continuous Measurement Start Flag (see note 2)		
9	DATAFLG		Continuous Measurement Stop Flag (see note 2)		
10	CMDFLG (see note 1)		Switch Scene Completed Flag (see note 2)		
11	TERMSTAT		Model Register Completed Flag (see note 2)		
12	CMDSTAT (see note 1)		One Measurement Completed Flag (see note 2)		
13	Empty		Empty		
14					
15					

- Note**
1. These bits are only valid if the input mode is Expand mode. (If the input mode is Basic mode these bits will always be 0.)
 2. These flags are only valid if the input mode is Basic mode. (If the input mode is Expand mode these bits will always be 0.)

10-6 Sample Ladder Program

This section gives a sample ladder program for the OMRON CVM1 Programmable Controller.

In this program, the scene is switched to scene 15 at power ON and one measurement is performed. The judgement for this measurement is then output back to the Programmable Controller.

10-6-1 Programmable Controller Settings

Node Address

Set the DIP switch to "2."

Settings Communications Specifications

Item	Setting	Bytes
Input mode	Basic	2 input bytes
Data output	OFF	6 output bytes
Response output	OFF	

Setting Expressions

Set the data 0 in *Expression/Data* to "R0.JG."

Setting Output Destinations

Select CompoBus/D as the output destination for data in *SYS/Output*.

10-6-2 Allocations for Programmable Controller

Word	Allocation
1902	Command input area. (Programmable Controller → F150)
2002	BUSY signal is allocated to bit 2 of this word.
2003	Judgement output area. (F150 → Programmable Controller)
2004	Response for the command input in word 1902 is allocated to the bits in this word.

10-6-3 Timing Charts

Scene Switching

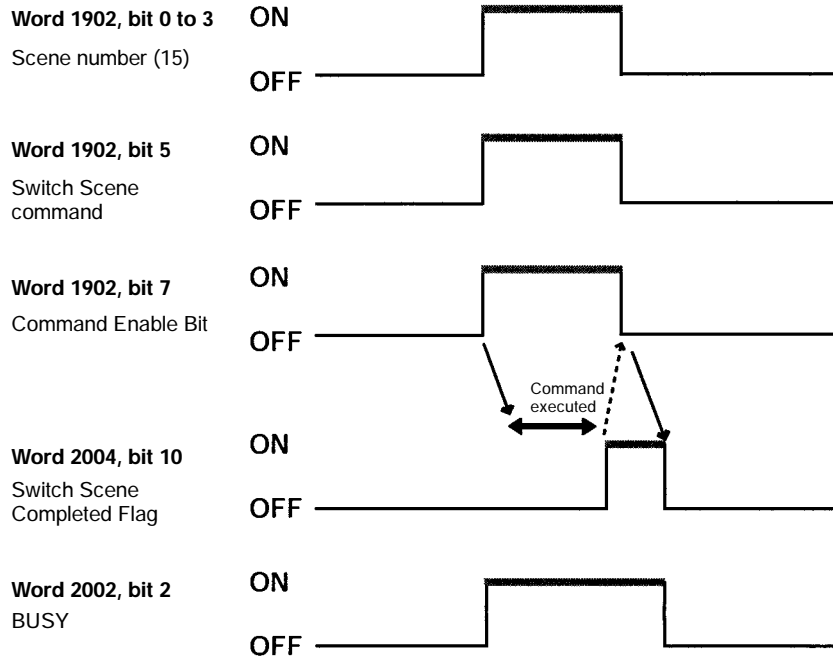

One Measurement

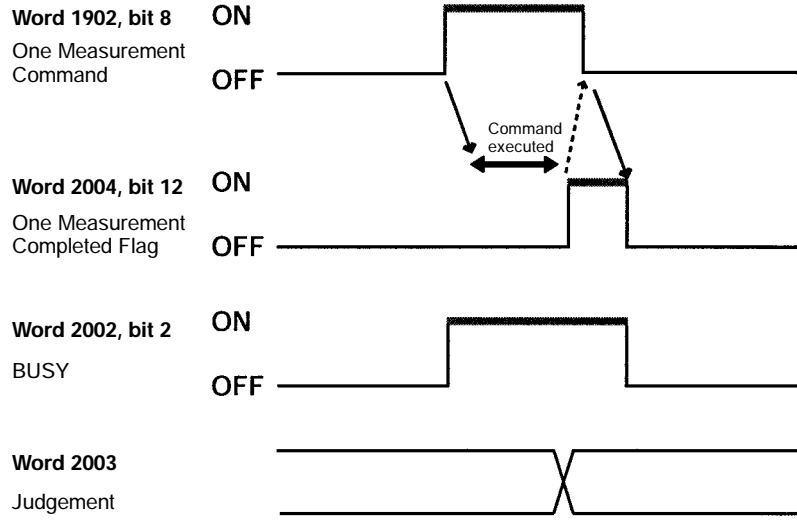

10-6-4 Ladder Program

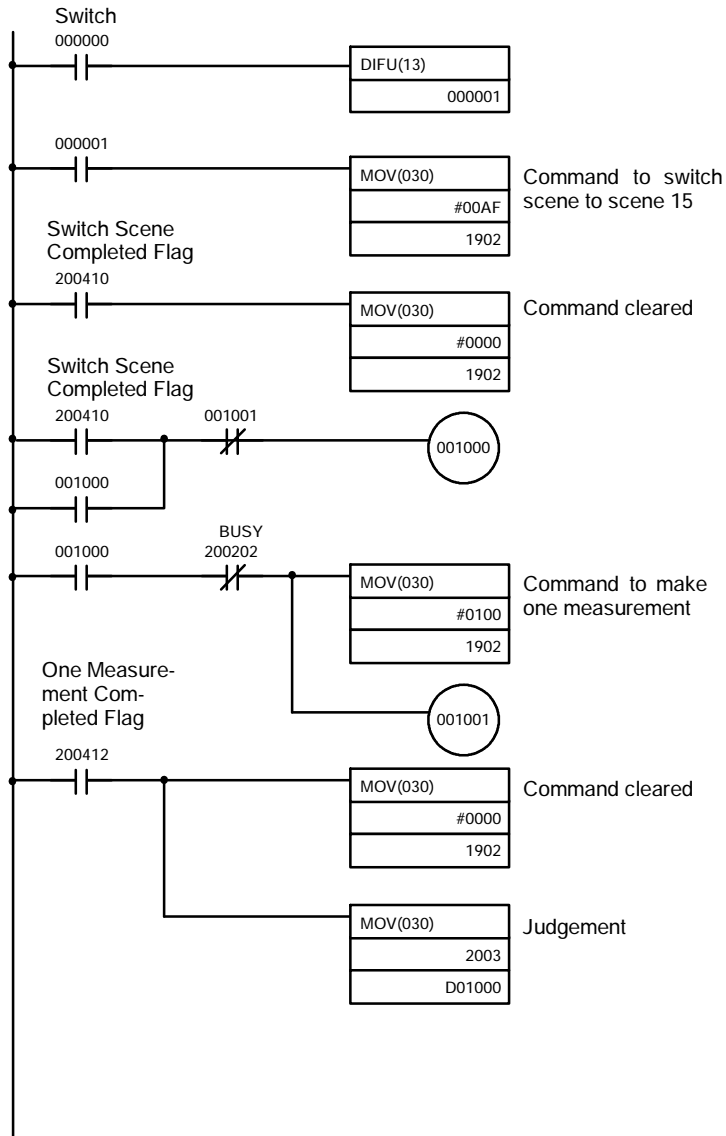

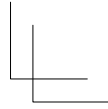
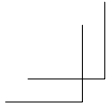

SECTION 11

RS-232C Menu Operation Settings

This section describes the communications settings for the RS-232C port when communications are in Menu operation mode. Menu operation mode allows F150 menus to be manipulated from a computer or other external device via the RS-232C port.

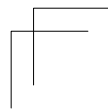
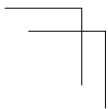

Make the same communications settings for the F150 and the external device. Set the F150 to Menu operation mode.

The measurement results will be output in Normal mode format in Menu operation mode. However, Xon/off flow control cannot be used (CTRL+S and CTRL+Q codes coincide).

Settings

Item	Settings	
Baud rate	2,400, 4,800, 9,600, 19,200, 38,400* (bps)	Use the same settings on the IBM PC/AT or compatible computer.
Data length	7, 8* (bits)	
Parity bits	None*, even, odd	
Stop bits	1*, 2 (bits)	
Delimiter	CR*, LF, CR+LF	
Mode	Select Menu (possible settings: Normal*, Host link, and Menu operation mode).	

Note The default settings are marked with asterisks.*

RS-232C Inputs Corresponding to Console Keys

The key codes shown in the right column in the following table can be input from an external device to perform the same functions as the Console keys shown on the left.

Console key	RS-232C input	
	Key	Code
ESC	CTRL + [(\$1B)
TRIG	CTRL + A	(\$01)
ENT	CTRL + M	(\$0D)
SHIFT + ESC	CTRL + I, Tab	(\$09)
SHIFT +TRIG	CTRL + T	(\$14)
SHIFT +ENT	CTRL + R	(\$12)
Up Key	CTRL + E	(\$05)
Down Key	CTRL + X	(\$18)
Left Key	CTRL + S	(\$13)
Right Key	CTRL + D	(\$04)
SHIFT +Up Key	CTRL + W	(\$17)
SHIFT +Down Key	CTRL + Z	(\$1A)
SHIFT +Left Key	CTRL + F	(\$06)
SHIFT +Right Key	CTRL + H	(\$08)
--- (see note)	CTRL + Q	(\$11)

Note CTRL + Q changes the RS-232C input to Normal mode. (Can only be input in Monitor or Run mode.)

Procedure

- 1** Display the Basic Screen for Monitor mode or Run mode.

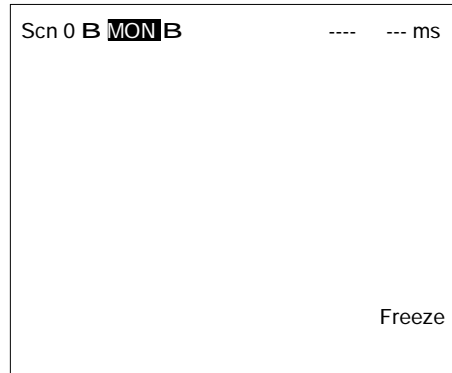

- 2** Move the cursor to **MON** or **RUN** and press the **ENT** Key.

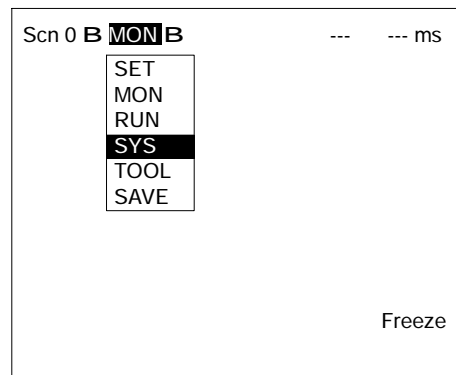

- 3** Select **SYS**.

4 Select **Communications**.

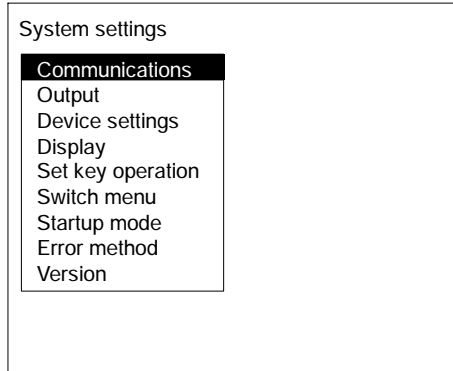

5 Select **RS-232C**.

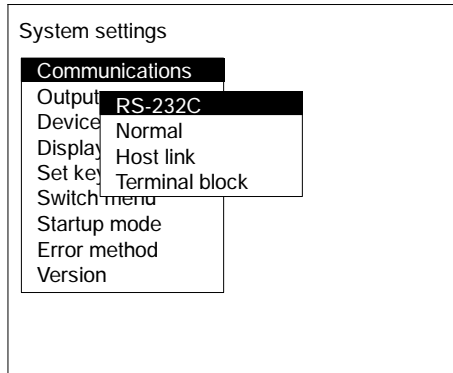

6 Set the items.

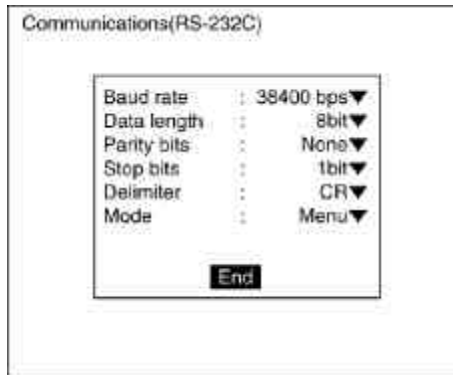

7 Select **End** to enter the settings.

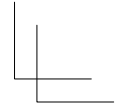
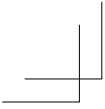

SECTION 12

Troubleshooting

This section lists the errors that may occur during F150 operation, along with their probable causes and remedies.

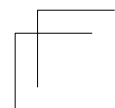
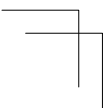

Message	Probable Cause and Countermeasure
Camera is not connected.*	Check the following: <ul style="list-style-type: none"> • Camera Cables are connected properly. • Both Cameras are connected when two Cameras are used.
Cannot measure the angle from one region.	Select a region for which binary center of gravity and axis angle has been set as the measurement method.
Communications error.*	Turn OFF the power to the F150 and restart. If the same error message appears, it may mean that the F150 is faulty. Contact your OMRON representative.
Set density so that the upper \neq the lower.	Set so that the lower limit of the density is smaller than the upper limit.
Draw at least one OR figure.	NOT mode is used to delete part of a drawn diagram. <ul style="list-style-type: none"> • Draw diagrams in OR mode.
Host link error. Change to normal mode. (see note)	After checking for the following items, either change the RS-232C mode to Host Link mode, or restart the F150: <ul style="list-style-type: none"> • The Programmable Controller is ON. • The RS-232C cable is connected properly. • The communications specifications for the Programmable Controller and the F150 are the same.
Illegal syntax in expression.	Check the following for the expression: <ul style="list-style-type: none"> • There are the same number of right and left parentheses. • There is not more than one operator in a row without a variable in between them. • There is not more than one function in a row without a variable in between them. • There is not more than one region number in a row. • There is not more than one constant in a row. • There are not too many, or too few arguments for a function.
Incorrect data format received.*	There is a mistake in the data for which transfer between the F150 and the external device was attempted. Turn OFF the power to the F150, and check for the following items before restarting the F150. <ul style="list-style-type: none"> • The RS-232C cable is connected properly. • The terminal block is wired correctly. If the same error message appears after restart, it may mean that the F150 is faulty. Contact your OMRON representative.

Message	Probable Cause and Countermeasure
Insufficient flash memory.	<p>An error has occurred in flash memory. Data cannot be saved because of insufficient available flash memory.</p> <ul style="list-style-type: none"> • Either make the region to be registered smaller, or clear unneeded regions from memory. <p>If the same error message appears after the regions have been reduced, it may mean that flash memory is faulty. Contact your OMRON representative.</p>
Insufficient work memory.	<p>No more regions can be registered because of insufficient available work memory.</p> <ul style="list-style-type: none"> • Either make the model or region to be registered smaller, or clear unneeded models or regions.
Intelligent Lighting is not selected.	<p>In SYS/Device settings, make the settings required for using an Intelligent Light Source.</p>
Programmable Controller is not in monitor mode.*	<p>Change the mode of the Programmable Controller to Monitor mode.</p>
Select midpoint between 2 regions for X and Y.	<p>If the relative angle of the 2 regions is set for the position compensation setting θ, the midpoint of the 2 regions must be set for X and Y.</p> <ul style="list-style-type: none"> • Either set midpoint of 2 regions for X and Y, or change the θ setting.
Select same region number for θ , X and Y.	<p>If position compensation region 0 or 1 is set for θ, then X and Y must be set to the same region number.</p> <ul style="list-style-type: none"> • Either set the same region number for X and Y, or change the θ setting.
Set parameters so that Output Period \square Gate ON delay + Gate ON time.	<p>The communications specifications for the terminal block are set incorrectly.</p> <ul style="list-style-type: none"> • Make the settings so that output period \square GATE ON delay + GATE ON time.
Setting calibration parameters is failed.	<p>The Camera magnification is outside the permitted setting range.</p> <ul style="list-style-type: none"> • Re-perform sampling so that the magnification is in the range 0.01 to 9.999.
	<p>Sampling has only been performed once.</p> <ul style="list-style-type: none"> • Perform sampling in at least 2 places.

Message	Probable Cause and Countermeasure
This region is not drawn.	A region that has not been drawn is selected as a displacement direction setting. <ul style="list-style-type: none">• Either draw the region, or select a region that has been drawn.
Timeout error.*	Data transfer has been interrupted due to a timeout error in communications between the F150 and an external device. Turn OFF the power to the F150, and check for the following items before restarting the F150. <ul style="list-style-type: none">• The RS-232C cable is connected properly.• The terminal block is wired correctly.• The communications specifications for the external device and the F150 are the same. If the same error message appears after restart, it may mean that the F150 is faulty. Contact your OMRON representative.

Note When the error messages marked with an asterisk are displayed, the ERR terminal will come ON.



Appendix A

Version Information

This appendix gives details of the functions that have been added as a result of software upgrading and provides information about data compatibility with previous versions of the software.

Data Compatibility

Scene Data

- Ver. 1.j j (F150-C10E) data cannot be used with this version.
- Ver. 2.j j (F150-C10E-2, F150-C15E-2, F150-C10E-2-DRT) data can be used with this version.

System Data

- Ver. 1.j j (F150-C10E) data cannot be used with this version.
- Ver. 2.j j (F150-C10E-2, F150-C15E-2, F150-C10E-2-DRT) data can be used with this version.

Functions (Ver. 2.1j to Ver. 3.0j)

Two Cameras with One Controller

With this version, by connecting a Two-camera Unit (F150-A20), two Cameras can be operated from just one Controller, and two images can be taken simultaneously. The default menu configuration is for operation with one Camera and so before using two Cameras, it is necessary to change the menu configuration. → p. 29

Light Control Menu

With this version, a menu for controlling light level has been added under **Set/Adjust**. When an Intelligent Light Source (F150-LTC20/LTC50) is used, this menu allows the light level to be controlled from the F150. RS-232C and CompoBus/D commands have been added that allow the light level to be controlled in this way from external devices. → p. 41, 59

Density Averaging and Relative Search

Two more measurement methods, density averaging and relative search, have been added with this version. → p. 10, 108, 112

Noise Level Added to Edge Detection Conditions

It is now possible to set a noise level that determines the existence of edges and so erroneous edge detection is reduced. → p. 93

Results Display Selection Increased

The following 5 items have been added to **Display result** under **SYS/Display settings**, enabling measurement results to be confirmed and judgement conditions to be adjusted with greater ease. In addition, the results of position compensation can be viewed in **All results of regions**. → p. 140

None	
Position compensation	
All results of regions	The results of position compensation have been added to All results of regions .
All positions of regions	
Individual region	
All judges	
Individual judge	
All data	
Individual data	
I/O monitor	Five new items have been added. Use I/O monitor to display the contents of I/O. Use Region, Judge, Data, and All to cyclically display data both individually and as a list.
[Region]	
[Judge]	
[Data]	
[All]	

Console Key Allocations

With this version, it is possible to change the functions assigned to the Console Keys in Monitor mode and Run mode. → p. 167

Output of Measurement Results via Terminal Block (F150-C10E-3, F150-C15E-3)

With the previous version, only judgement results could be output to the terminal block. With this version, however, data can also be output. Select **Terminal block** as the output destination in **SYS/Output**. → p. 155

Set the actual contents of data output in **Expressions/Data**. → p. 121

New Mode for Data Backup

A new mode, Tool mode, has been added. Select this menu to immediately display a menu showing the different kinds of data that can be saved. In addition, when saving image data, select the images to be saved from memory numbers displayed.

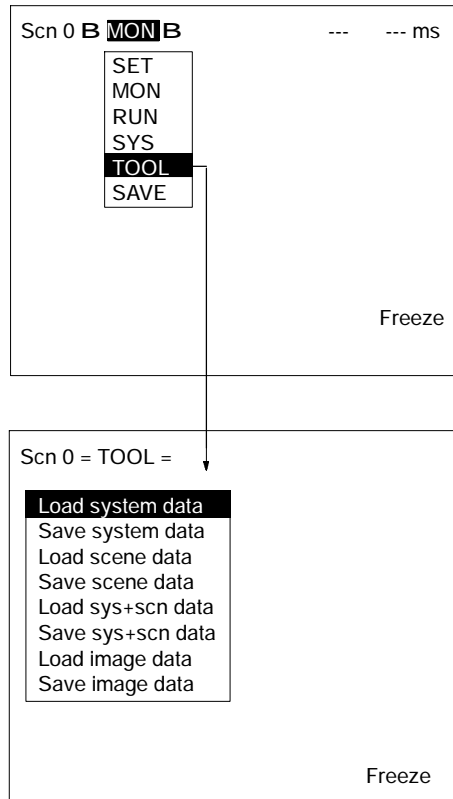

Index

A

ABS, 126
all data, 147
all judges, 146
all positions of regions, 145
allocations, 315, 318
ANGL, 127
ATAN, 127

B

background suppression
 object measurement, 49
 position compensation, 64
backup, 177
baud rate
 CompoBus/D, 277
 menu operation, 324
 RS-232C (host link), 236
 RS-232C (normal), 200
binary center of gravity and area
 object measurement, 82
 output expressions, 124
 overview, 4
 parameter lists, 214, 218, 246, 249, 259,
 286, 289, 298
 position compensation, 66
binary center of gravity and axis angle
 object measurement, 82
 output expressions, 124
 overview, 5
 parameter lists, 214, 218, 246, 249, 259,
 286, 289, 298
 position compensation, 67
binary level
 object measurement, 83
 position compensation, 68

C

calibration, 3
camera modes, 34
 Camera 0/1 modes, 39
 changing, 40
commands
 See also CompoBus/D commands;
 RS-232C (host link) commands;
 RS-232C (normal) commands; termi-
 nal blocks commands
 measurement, 198
 non-measurement, 200
communications
 errors, 274
 flowcharts
 RS-232C (host link), 232
 RS-232C (normal), 198
 mode
 RS-232C (host link), 236
 RS-232C (normal), 200
 monitoring I/O, 148
 settings
 CompoBus/D, 273
 menu operation, 324
 RS-232C (host link), 232, 236
 RS-232C (normal), 200
 terminal blocks, 184
 specifications, 17
compare pitch, 107
CompoBus/D, 3
 commands
 Continuous Measurement, 279, 283
 Decrement Scene, 284
 Increment Scene, 284
 Model Register, 280, 285
 One Measurement, 278, 283
 Read Data Output Expression Result,
 299
 Read Judgement Output Expression Cri-
 teria, 294
 Read Judgement Output Expression Re-
 sult, 299
 Read Light Level, 295
 Read Measurement, 285
 Read Parameter, 293
 Read Position, 296

Index

- Read Scene Number, 284
 - Reset, 281, 285
 - Save Data, 285
 - Set Judgement Output Expression Criteria, 294
 - Set Light Level, 295
 - Set Parameter, 289
 - Stop Measurement, 279, 283
 - Switch Scene, 279, 284
 - measurement results, 281
 - operation, 281
 - settings, 269, 282
 - console keys, 22
 - changing allocations, 169
 - combinations, 24
 - coordinates, obtaining, 224
 - cursor, 24
- D**
- data
 - compatibility between versions, 331
 - loading, 206
 - image data, 210
 - scenes, 178
 - system data, 178, 228
 - output destination, 123
 - output expressions, 129
 - saving, 206, 207, 244, 285
 - image data, 210
 - scenes, 178
 - system data, 178, 229
 - scene data
 - clearing, 135
 - copying, 134
 - data areas. *See* memory areas
 - defect, calculation, 107
 - density averaging, 331
 - object measurement, 108
 - output expressions, 124
 - overview, 10
 - parameter lists, 215, 220, 247, 251, 287, 291
 - DIP switch settings, Intelligent Light Source, 43
 - direction, position compensation, 77
 - DIST, 127
 - drawing mode, 28
- E**
- edge pitch
 - object measurement, 95
 - output expressions, 125
 - overview, 8
 - parameter lists, 214, 219, 247, 250, 288, 291
 - edges
 - enhancement. *See* filtering
 - extraction. *See* filtering
 - element size, 107
 - errors, 274
 - troubleshooting, 327
 - evaluation criteria, setting, 80, 88, 103, 112, 118
 - expressions
 - output, 122
 - possible settings, 123
- F**
- features, 2
 - filtering
 - object measurement, 48
 - position compensation, 64
 - flash memory, 181
 - flow control, RS-232C (normal), 203
 - functions
 - display, 24
 - output expressions, 126
 - upgrades, 331
- G**
- GATE terminal, 280, 282, 300
 - gray edge position
 - object measurement, 91
 - output expressions, 124
 - overview, 7

Index

- parameter lists, 215, 218, 246, 249, 258, 287, 290, 297
- position compensation, 71
- gray search
 - object measurement, 98
 - output expressions, 125
 - overview, 6
 - parameter lists, 215, 219, 247, 250, 259, 287, 290, 298
 - position compensation, 73
- input terminals
 - for continuous measurement, 192
 - non-measurement commands, 194, 195
 - using STEP signal, 190
- installation, overview, 16
- Intelligent Light Source, 41
 - adjusting light level, 59, 212
 - lighting control, 331
 - monitoring light level, 211
 - settings, 158

H-I

- handshaking
 - with, 193
 - without, 189
- Horizontal Composition modes, 38
- host link, commands. *See* RS-232C (host link) commands
- I/O formats. *See* input format; output format
- I/O monitor, 148
- images
 - adjusting, 47
 - for position compensation, 64
 - changing, 166
 - overview, 3
 - storing, 162, 207
 - types displayed, 24
- individual data, 147
- individual judge, 147
- individual region, 146
- input, 17
 - area, 273, 317
 - commands, 153
 - See also* CompoBus/D commands;
 - RS-232C (host link) commands;
 - RS-232C (normal) commands; terminal blocks commands
 - devices, overview, 22
 - DI0 to DI7, 187
 - format
 - CompoBus/D, 278, 282
 - RS-232C (host link), 242
 - RS-232C (normal), 207
 - terminal blocks, 187
 - numeric values, 26
 - parameters, 55

J-L

- JG, 127
- judgement
 - output, 304
 - output expressions, 122, 129, 209
- keys. *See* console keys
- ladder diagram, 267, 321
- lighting control, 2, 331
 - adjusting light level, 59, 212, 256, 295
 - Intelligent Light Source, 41
 - monitoring light level, 211, 256, 295
- loading. *See* data loading

M

- MAX, 126
- measurement
 - continuous, 187, 191
 - command, 222, 243, 279, 283
 - timing, 310, 313
 - enhancement, 2
 - performing, 152
 - single
 - command, 222, 242, 278, 283
 - timing, 309, 312, 320
 - stop, command, 222, 243, 283
- measurement conditions, 45
- measurement images. *See* images
- measurement methods, 4, 80
- measurement regions
 - drawing, 28
 - functions, 80
- measurement results

Index

- commands
 - CompoBus/D, 281
 - RS-232C (host link), 241
 - RS-232C (normal), 206
 - displaying, 142
 - reading, 213, 241, 245, 285
 - memory areas
 - allocations, 266
 - setting, 239
 - menus
 - hierarchy, 12
 - moving around, 25
 - midpoint, 77
 - MIN, 126
 - models, registering, 99, 187, 223, 244, 280, 285, 311
 - modes
 - camera modes, 34
 - overview, 24
 - Monitor mode, 138
 - monitoring
 - I/O monitor, 148
 - regions and results, 149
- ### N-O
- numeric values. *See* input
 - operation
 - basic, 19
 - commands
 - CompoBus/D, 281
 - RS-232C (host link), 241
 - RS-232C (normal), 205
 - timing, 315
 - menu, 22, 223
 - overview, 16
 - output, 17
 - area, 272, 316
 - calibration, 50
 - control output, 303
 - destinations, 157
 - expressions, 122
 - evaluation criteria, 254, 255, 294
 - functions, 126
 - reading results, 208, 260, 261, 299
 - format, 153
 - CompoBus/D, 301
 - RS-232C (host link), 262
 - RS-232C (normal), 229
 - terminal blocks, 188
 - response, 282, 305
 - status, 305
 - output terminals, 188
 - error terminal, 174
 - GATE terminal, 280, 282, 300
 - non-measurement commands, 194
 - with handshaking, 193, 194
 - without handshaking
 - for continuous measurement, 192
 - using STEP signal, 191
- ### P
- parameters
 - inputting, 55
 - position compensation, 225
 - reading/setting, 216, 248, 253, 289, 293
 - reference, 58
 - pixel-skipping parameter, 76, 104, 119
 - ports. *See* terminal blocks
 - position compensation, 2, 62
 - direction, 77
 - displaying results, 144, 224
 - midpoint, 77
 - parameter lists, 258, 297
 - parameters, 225
 - reading measurement values, 257, 296
 - relative angle, 77
 - position displacement compensation. *See* position compensation
 - precautions, general, xi
 - precise search
 - object measurement, 98
 - output expressions, 125
 - overview, 6
 - parameter lists, 215, 219, 247, 250, 287, 290
 - programming, sample, 265, 318

Q-R

- quitting, 20
- relative angle, 77
- relative search, 331
 - object measurement, 112
 - output expressions, 126
 - overview, 10
 - parameter lists, 216, 221, 248, 252, 288, 292
- resetting, 226, 245, 285
- response output, 282
- RS-232C
 - inputs, 324
 - menu operation, 23
 - settings, 323
- RS-232C (host link)
 - commands
 - Continuous Measurement, 243
 - Decrement Scene, 243
 - Increment Scene, 243
 - One Measurement, 242
 - Model Register, 244
 - Read Data Output Expression Result, 261
 - Read Judgement Output Expression Criteria, 255
 - Read Judgement Output Expression Result, 260
 - Read Light Level, 256
 - Read Measurement, 245
 - Read Parameter, 253
 - Read Position, 257
 - Read Scene Number, 244
 - Reset, 245
 - Save Data, 244
 - Set Judgement Output Expression Criteria, 254
 - Set Light Level, 256
 - Set Parameter, 248
 - Stop Measurement, 243
 - Switch Scene, 243
 - I/O, 233
 - measurement results, 241
 - operation, 241
 - settings, 231, 242
- RS-232C (normal)
 - commands
 - Data Save, 207
 - Display Image, 207
 - Expression, 208
 - Expression Parameter, 209
 - Image Load, 210
 - Image Save, 210
 - Light Parameter, 211
 - Measure, 221
 - Measure Data, 213
 - Measure Parameter, 216
 - MENUKEY, 223
 - Model Set, 223
 - Position Data, 224
 - Position Parameter, 225
 - Reset, 226
 - Scene, 227
 - Scene Load, 227
 - Scene Save, 228
 - System Load, 228
 - System Save, 229
 - Version Get, 229
 - I/O, 198
 - measurement results, 206
 - operation, 205
 - save/load, 206
 - settings, 197, 206
- Run mode
 - entering, 151
 - performing measurement, 152

S

- sampling, 51
- saving. *See* data saving
- scenes
 - changing, 2, 132, 187, 243, 279, 284, 311, 319
 - clearing, 135
 - copying, 134
 - data, 227
 - See also* data
 - loading, 227
 - number, 24
 - decrementing, 243, 284
 - incrementing, 243, 284
 - reading, 244, 284
 - saving, 228
- screen, display, 23
 - measurement results, 142
 - settings, 160
- search regions, setting, 102, 116



Index

Set mode, 46

settings

changing/clearing, 79, 120

commands

CompoBus/D, 282

RS-232C (host link), 242

RS-232C (normal), 206

displaying, 277

Programmable Controller, 318

shutter speed, 2, 47

smoothing. *See* filtering

software version, 175, 229, 331

SQRT, 126

starting, 20

startup scene and mode, 172

STEP signal

with handshaking, 193

without handshaking, 189, 190

STEP terminal, 187

RS-232C (host link), 234

RS-232C (normal), 199

surface defect, 105

output expressions, 125

overview, 9

parameter lists, 215, 220, 247, 253, 287,
293

system, data. *See* data

System mode, 156

T-W

terminal blocks, 3, 183

commands, 187

terminals

See also input terminals; output terminals

signal operation and timing, 189

test measurement, 139

timing, 309, 319

Tool mode, 179, 333

troubleshooting, 327

Two-camera Switching mode, 38

Two-camera Unit, 3, 29, 331

menus, 13, 32

settings, 158

TXD instructions, 235

values. *See* input

version. *See* software version

Vertical Composition mode, 38

wiring, overview, 16

Revision History

A manual revision code appears as a suffix to the catalog number on the front cover of the manual.

Cat. No. Z142-E3-1

↑
Revision code

The following table outlines the changes made to the manual during each revision.

Revision code	Date	Revised content
Z142-E1	April 2000	Original production
Z142-E1-1A	October 2000	Page 262: Added information on Write Flag to the description above the table. Page 266: Corrected values in the diagram. Address: Updated the addresses.
Z142-E3-1	August 2001	Page 29: corrected one statement near top of page.



OMRON ELECTRONICS LLC

1 Commerce Drive
Schaumburg, IL 60173 USA
800.55.OMRON (66766)

OMRON CANADA, INC.

885 Milner Avenue
Scarborough, Ontario M1B 5V8
416.286.6465

OMRON ON-LINE

Global - <http://www.omron.com>
USA - <http://www.omron.com/oei>
Canada - <http://www.omron.com/oci>

24 HOUR FAX ON DEMAND

USA - 847.843.1963
Canada - 788.599.4264

For Distributor Locations or Product Information, Call:

800.55.OMRON or 847.843.7900

UNITED STATES REGIONAL SALES OFFICES

Northeast	Boston, MA	508.303.8880
East	Philadelphia, PA	610.524.1897
Southeast	Atlanta, GA	770.798.6780
Central	Cincinnati, OH	513.469.6766
Midwest	Chicago, IL	847.843.7910
Southwest	Dallas, TX	972.871.2166
West	Los Angeles, CA	714.621.3455

CANADA REGIONAL SALES OFFICES

Ontario	Toronto	416.286.6465
	Kitchener	519.896.1144
	Kingston	613.376.3968
Quebec	Montreal	514.636.6676
	Ste-Foy	418.864.7378
British Columbia	Vancouver	604.522.8855
Alberta	Edmonton	403.440.0818
	Calgary	403.257.3095

BRAZIL SALES OFFICE

Sao Paulo 55.11.5564.6488

ARGENTINA SALES OFFICE

Buenos Aires 54.114.787.1129

MEXICO/LATIN AMERICA SALES OFFICE

Florida 954.227.2121