

RFID System

# V600 Series

**User's Manual**

Hand-held Reader Writer

V600-CHUD

Data Carriers

V600 Series

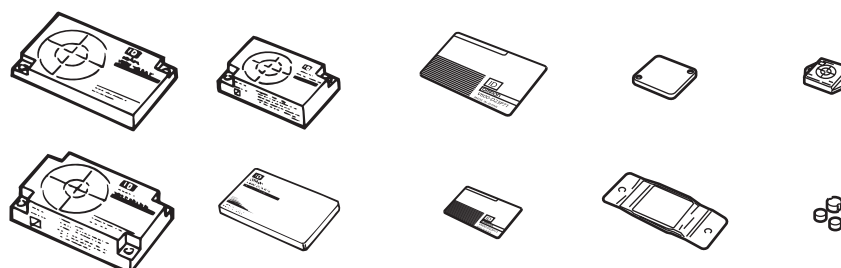
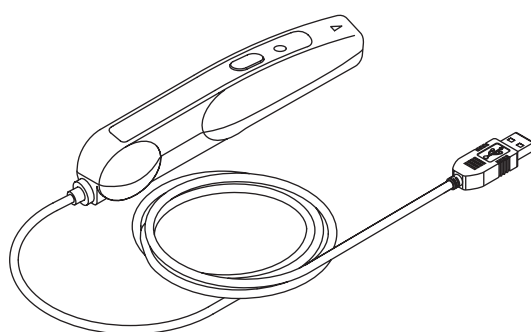



Introduction	Application Considerations (Read and understand this information first.)	Introduction
Section 1	Product Overview	Section 1
Section 2	Communications Preparations	Section 2
Section 3	Commands	Section 3
Section 4	Functions	Section 4
Section 5	Troubleshooting	Section 5
Section 6	Appendices	Section 6

# RFID System

V600-CHUD Hand-held Reader Writer

# User's Manual

**READ AND UNDERSTAND THIS DOCUMENT**

Please read and understand this document before using the products. Please consult your OMRON representative if you have any questions or comments.

**WARRANTY**

OMRON's exclusive warranty is that the products are free from defects in materials and workmanship for a period of one year (or other period if specified) from date of sale by OMRON.

OMRON MAKES NO WARRANTY OR REPRESENTATION, EXPRESS OR IMPLIED, REGARDING NON-INFRINGEMENT, MERCHANTABILITY, OR FITNESS FOR PARTICULAR PURPOSE OF THE PRODUCTS. ANY BUYER OR USER ACKNOWLEDGES THAT THE BUYER OR USER ALONE HAS DETERMINED THAT THE PRODUCTS WILL SUITABLY MEET THE REQUIREMENTS OF THEIR INTENDED USE. OMRON DISCLAIMS ALL OTHER WARRANTIES, EXPRESS OR IMPLIED.

**LIMITATIONS OF LIABILITY**

OMRON SHALL NOT BE RESPONSIBLE FOR SPECIAL, INDIRECT, OR CONSEQUENTIAL DAMAGES, LOSS OF PROFITS OR COMMERCIAL LOSS IN ANY WAY CONNECTED WITH THE PRODUCTS, WHETHER SUCH CLAIM IS BASED ON CONTRACT, WARRANTY, NEGLIGENCE, OR STRICT LIABILITY.

In no event shall responsibility of OMRON for any act exceed the individual price of the product on which liability is asserted.

IN NO EVENT SHALL OMRON BE RESPONSIBLE FOR WARRANTY, REPAIR, OR OTHER CLAIMS REGARDING THE PRODUCTS UNLESS OMRON'S ANALYSIS CONFIRMS THAT THE PRODUCTS WERE PROPERLY HANDLED, STORED, INSTALLED, AND MAINTAINED AND NOT SUBJECT TO CONTAMINATION, ABUSE, MISUSE, OR INAPPROPRIATE MODIFICATION OR REPAIR.

**SUITABILITY FOR USE**

THE PRODUCTS CONTAINED IN THIS DOCUMENT ARE NOT SAFETY RATED. THEY ARE NOT DESIGNED OR RATED FOR ENSURING SAFETY OF PERSONS, AND SHOULD NOT BE RELIED UPON AS A SAFETY COMPONENT OR PROTECTIVE DEVICE FOR SUCH PURPOSES. Please refer to separate catalogs for OMRON's safety rated products.

OMRON shall not be responsible for conformity with any standards, codes, or regulations that apply to the combination of products in the customer's application or use of the product.

At the customer's request, OMRON will provide applicable third party certification documents identifying ratings and limitations of use that apply to the products. This information by itself is not sufficient for a complete determination of the suitability of the products in combination with the end product, machine, system, or other application or use.

The following are some examples of applications for which particular attention must be given. This is not intended to be an exhaustive list of all possible uses of the products, nor is it intended to imply that the uses listed may be suitable for the products:

- Outdoor use, uses involving potential chemical contamination or electrical interference, or conditions or uses not described in this document.
- Nuclear energy control systems, combustion systems, railroad systems, aviation systems, medical equipment, amusement machines, vehicles, safety equipment, and installations subject to separate industry or government regulations.
- Systems, machines, and equipment that could present a risk to life or property.

Please know and observe all prohibitions of use applicable to the products.

NEVER USE THE PRODUCTS FOR AN APPLICATION INVOLVING SERIOUS RISK TO LIFE OR PROPERTY WITHOUT ENSURING THAT THE SYSTEM AS A WHOLE HAS BEEN DESIGNED TO ADDRESS THE RISKS, AND THAT THE OMRON PRODUCT IS PROPERLY RATED AND INSTALLED FOR THE INTENDED USE WITHIN THE OVERALL EQUIPMENT OR SYSTEM.

**PERFORMANCE DATA**

Performance data given in this document is provided as a guide for the user in determining suitability and does not constitute a warranty. It may represent the result of OMRON's test conditions, and the users must correlate it to actual application requirements. Actual performance is subject to the OMRON Warranty and Limitations of Liability.

**CHANGE IN SPECIFICATIONS**

Product specifications and accessories may be changed at any time based on improvements and other reasons.

It is our practice to change model numbers when published ratings or features are changed, or when significant construction changes are made. However, some specifications of the product may be changed without any notice. When in doubt, special model numbers may be assigned to fix or establish key specifications for your application on your request. Please consult with your OMRON representative at any time to confirm actual specifications of purchased products.

**DIMENSIONS AND WEIGHTS**

Dimensions and weights are nominal and are not to be used for manufacturing purposes, even when tolerances are shown.

**ERRORS AND OMISSIONS**

The information in this document has been carefully checked and is believed to be accurate; however, no responsibility is assumed for clerical, typographical, or proofreading errors, or omissions.

**PROGRAMMABLE PRODUCTS**

OMRON shall not be responsible for the user's programming of a programmable product, or any consequence thereof.

**COPYRIGHT AND COPY PERMISSION**

This document shall not be copied for sales or promotions without permission. This document is protected by copyright and is intended solely for use in conjunction with the product. Please notify us before copying or reproducing this document in any manner, for any other purpose. If copying or transmitting this document to another, please copy or transmit it in its entirety.

## Meanings of Signal Words

The following signal words are used in this manual.



**WARNING**

Indicates a potentially hazardous situation which, if not avoided, will result in minor or moderate injury, or may result in serious injury or death. Additionally, there may be significant property damage.



**CAUTION**

Indicates a potentially hazardous situation which, if not avoided, may result in minor or moderate injury or in property damage.

## Meanings of Alert Symbols

The following alert symbols are used in this manual.



Indicates the possibility of explosion under specific conditions.



Indicates general prohibitions for which there is no specific symbol.

## Alert statements in this Manual

The following alert statements apply to the products in this manual. Each alert statement also appears at the locations needed in this manual to attract your attention.



**WARNING**



This product is not designed to be used either directly or indirectly in applications that detect human presence for the purpose of maintaining safety. Do not use this product as a sensing device for protecting human lives.



A lithium battery is built into SRAM Data Carriers and may occasionally combust, explode, or burn if not treated properly. Dispose of SRAM Data Carriers as industrial waste and never disassemble, apply pressure that would deform, heat to higher than 100°C, or incinerate SRAM Data Carriers.

## Regulations and Standards

The V600-CHUD series complies with the following standards.

1. FCC (USA Federal Communications Commission)

FCC Part 15 Subpart C

FCC ID:E4E6CYCIDV6000203

2. Europe Radio and EMC Standards

The requirements of the EC/R&TTE Directive (Radio and Telecommunications Terminal Equipment Directive 1999/5/EC) have been met.

Radio: EN300330-2 V1.1.1(06-2001) EN300300-1 V1.3.1(06-2001)

EMC: EN301489-3 V1.4.1(08-2002) EN301489-1 V1.4.1(08-2002)

Safety: EN61010-1:2001(2<sup>ND</sup> Edition)



Countries of intended use:

Finland, Germany, Iceland, Sweden

English	Hereby, Omron, declares that this V600-CHUD(-X) is in compliance with the essential requirements and other relevant provisions of Directive 1999/5/EC.
Finnish	Omron vakuuttaa täten että V600-CHUD(-X) tyyppinen laite on direktiivin 1999/5/EY oleellisten vaatimusten ja sitä koskevien direktiivin muiden ehtojen mukainen.
Swedish	Härmed intygar Omron att denna V600-CHUD(-X) står i överensstämmelse med de väsentliga egenskapskrav och övriga relevanta bestämmelser som framgår av direktiv 1999/5/EG.
German	Hiermit erklärt Omron, dass sich dieser/diese/dieses V600-CHUD(-X) in Übereinstimmung mit den grundlegenden Anforderungen und den anderen relevanten Vorschriften der Richtlinie 1999/5/EG befindet. (BMW)

## Precautions for Safe Use

Observe the following precautions to ensure safe use of the product.

1. Do not use the product in environments with flammable, explosive, or corrosive gasses.
2. Do not attempt to disassemble, repair, or modify the product.
3. The USB driver must be installed in the personal computer before connecting the V600-CHUD to a personal computer.
4. Do not subject cables to excessive loads.
5. Observe all warnings and precautions given in the body of this manual.
6. Discontinue usage and turn OFF the power supply immediately if you notice any unusual odors, if the product is abnormally hot, or if the product starts smoking.
7. When disposing of the product, treat it as industrial waste.

## Precautions for Correct Use

Always observe the following precautions to prevent operation failures, malfunctions, and adverse effects on performance and equipment.

### 1. Installation Environment

Install the product in the following locations:

- Locations not subject to corrosive gas, dust, metallic powder, or salt.
- Locations within the specified operating temperature range.
- Locations not subject to rapid changes in temperature (with no condensation).
- Locations within the specified humidity range.
- Locations not subject to direct vibration or shock outside the specified ranges.
- Locations not subject to water, oil, or chemicals.

### 2. Installation

- The product communicates with Data Carriers using the 530-kHz frequency band. Some motors, inverters, switching power supplies, and other devices generate noise that can affect communications with the Data Carriers. If such devices are located near the Data Carriers, communications with the Data Carriers may be adversely affected or the Data Carriers may be destroyed. Whenever using the product near devices of this nature, always test operation in advance to confirm if the system will be affected.
- Observe the following precautions to minimize the effects of normal noise.
  - (1) Ground all metal objects in the vicinity to 100  $\Omega$  or less.
  - (2) Do not use the system near high-voltage or high-current lines.
- Connectors are not waterproof. Do not use the product where mists are present.
- Do not use chemicals that would affect the materials used in the product.
- Always be sure the USB connector is properly inserted when using the USB port.

### 3. Cleaning

- Do not clean the product with thinners, benzene, or other organic solvents. These will dissolve the resin parts and coating on the case.

# How to Read this Manual

---

## Meanings of Symbols



CHECK!

Indicates particularly important points related to a function, including precautions and application advice.



Indicates page numbers containing relevant information.



Indicates reference to helpful information and explanations for difficult terminology.



# Table of Contents

Meanings of Signal Words	3
Meanings of Alert Symbols	3
Alert statements in this Manual	3
Precautions for Safe Use	5
Precautions for Correct Use	5
How to Read this Manual	6
Table of Contents	7
<hr/>	
Section 1 Product Overview	9
<hr/>	
Features	10
Names and Functions of Components	11
System Configuration	12
Operation Flowchart	13
<hr/>	
Section 2 Communications Preparations	15
<hr/>	
Connections	16
Installing the USB Driver	17
Communications Test	26
<hr/>	
Section 3 Commands	29
<hr/>	
Communications with the Data Carrier	30
Command and Response Format	34
Communications Commands	38
Communications Subcommands	77
Host Commands	78
Evaluation Commands	79
Other Commands	81
End code List	82

Section 4 Functions	83
Hand-held Reader Writer Functions	84
Data Carrier	85
Section 5 Troubleshooting	95
Error Tables	96
Troubleshooting Flowchart	97
Section 6 Appendices	99
Specifications and Dimensions	100
Data Carrier Memory Map	106
Data Carrier Memory Capacity and Data Type (V600 Series)	107
List of ASCII Characters	108
Degree of Protection	109
Revision History	111

# Section 1

## Product Overview

☒ Features	10
☒ Names and Functions of Components	11
☒ System Configuration	12
☒ Operation Flowchart	13

# Features

The V600-CHUD Hand-held Reader Writer incorporates a V600-series Antenna and Controller into a compact device conforming to USB 1.1. Data can be read from or written to the Data Carrier simply by approaching or touching the Data Carrier with the Hand-held Reader Writer.

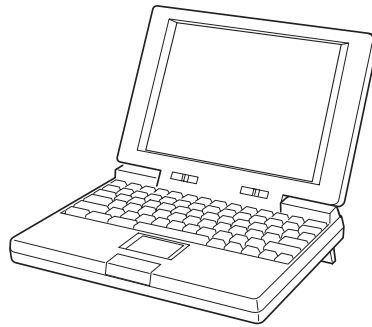

Personal computer

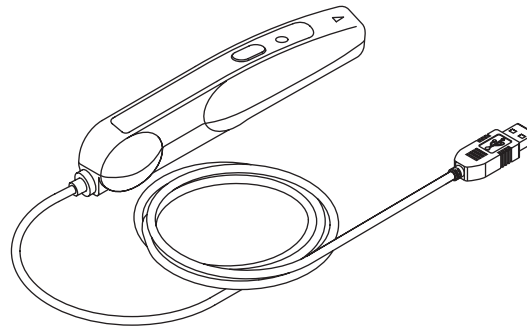

Hand-held Reader Writer

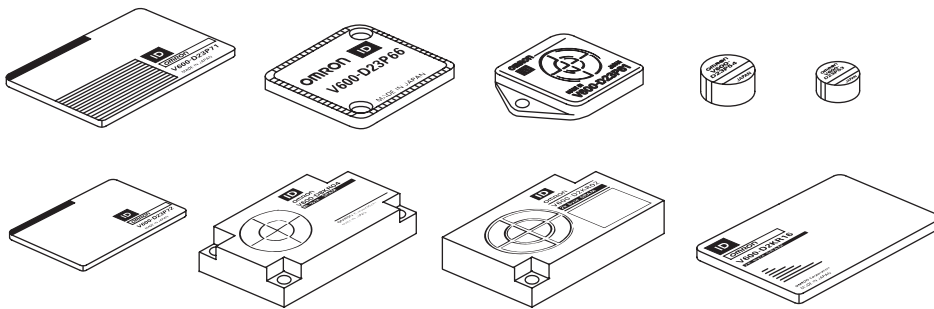



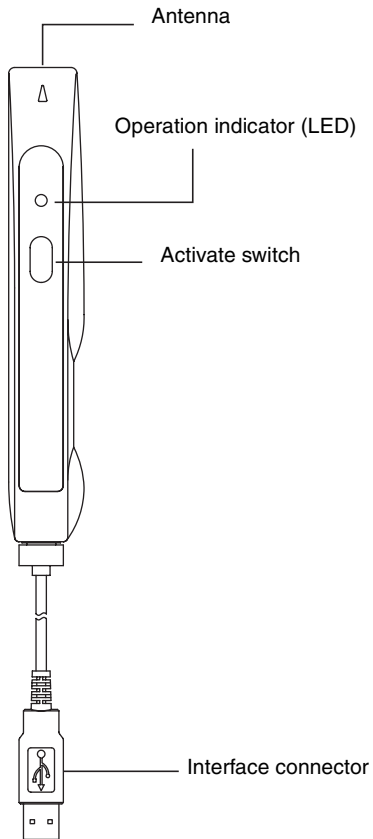

Data Carriers

# Names and Functions of Components

V600-CHUD



## •Operation Indicator (LED)

Display	Meaning
 Lit green	A command has been received from the host device.
	Communications with the Data Carrier have completed normally.
	The execution result of the noise detection command (NS) is "A" (low noise).
 Flashing green	The result of the error noise detection command (EN) is "0" (normal).
	When the power is turned ON, after initialization of the Hand-held Reader Writer is completed
 Lit red	Communications with the Data Carrier are in progress.
	A communications error with the Data Carrier has occurred.
 Flashing red	A CPU error has occurred.
	A Data Carrier non-existent error has occurred.
	A communications error with the host device has occurred.
	The execution result of the noise detection command (NS) is "B" (high noise).
	The result of the error noise detection command (EN) is "1" (error).



After the operation indicator is lit or flashing for a certain time, it will turn OFF.

CHECK!

## •Activate Switch

When button commands (button commands, button auto commands) are used and the activate switch is pressed, communications with the Data Carrier will commence. (For details on button commands, refer to Section 3 Commands.)

## •Interface Connector

This is a USB interface with an A-series plug based on USB 1.1.

## •Antenna

To communicate with the Data Carrier, move the antenna head closer to it.

# System Configuration

## V600-CHUD

The V600-CHUD Hand-held Reader Writer can communicate with host devices that have a USB interface such as personal computers.

### Host Devices

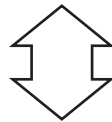
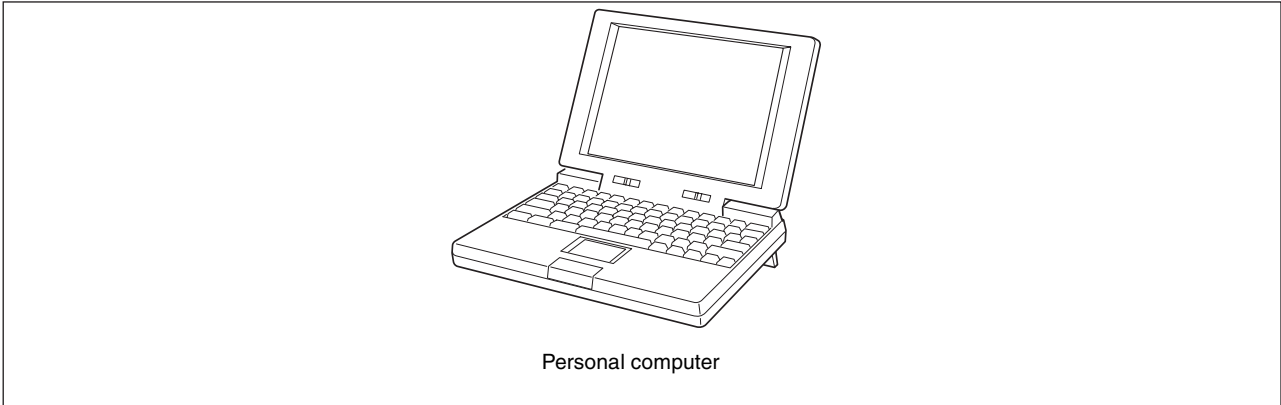

### Handheld Reader Writer

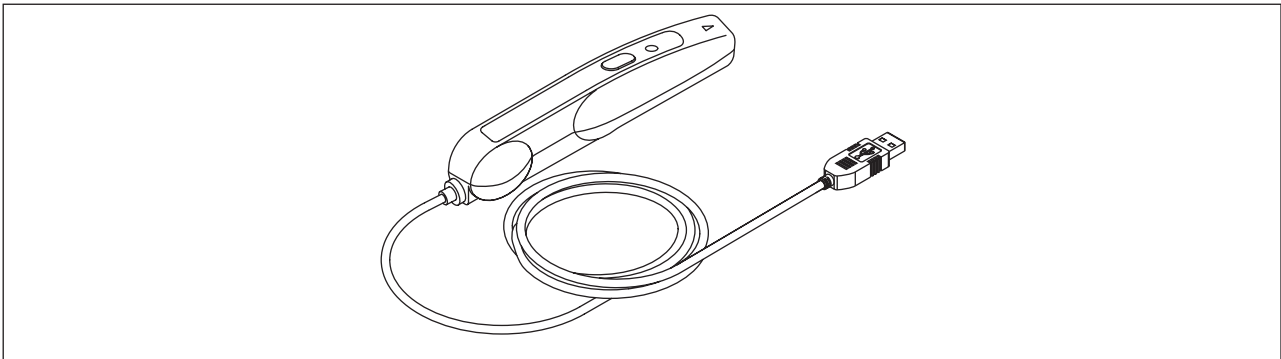

### Data Carriers

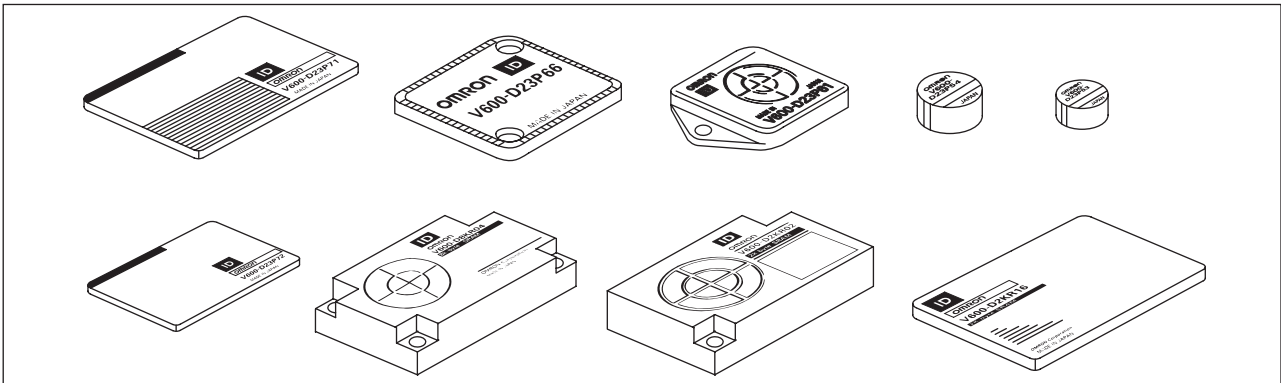

The V600-CHUD Hand-held Reader Writer can be used with any Data Carrier in the V600 Series.



For details on Hand-held Reader Writer and Data Carrier models, refer to Section 6 Appendices.

CHECK!



p.100, p.107

# Operation Flowchart

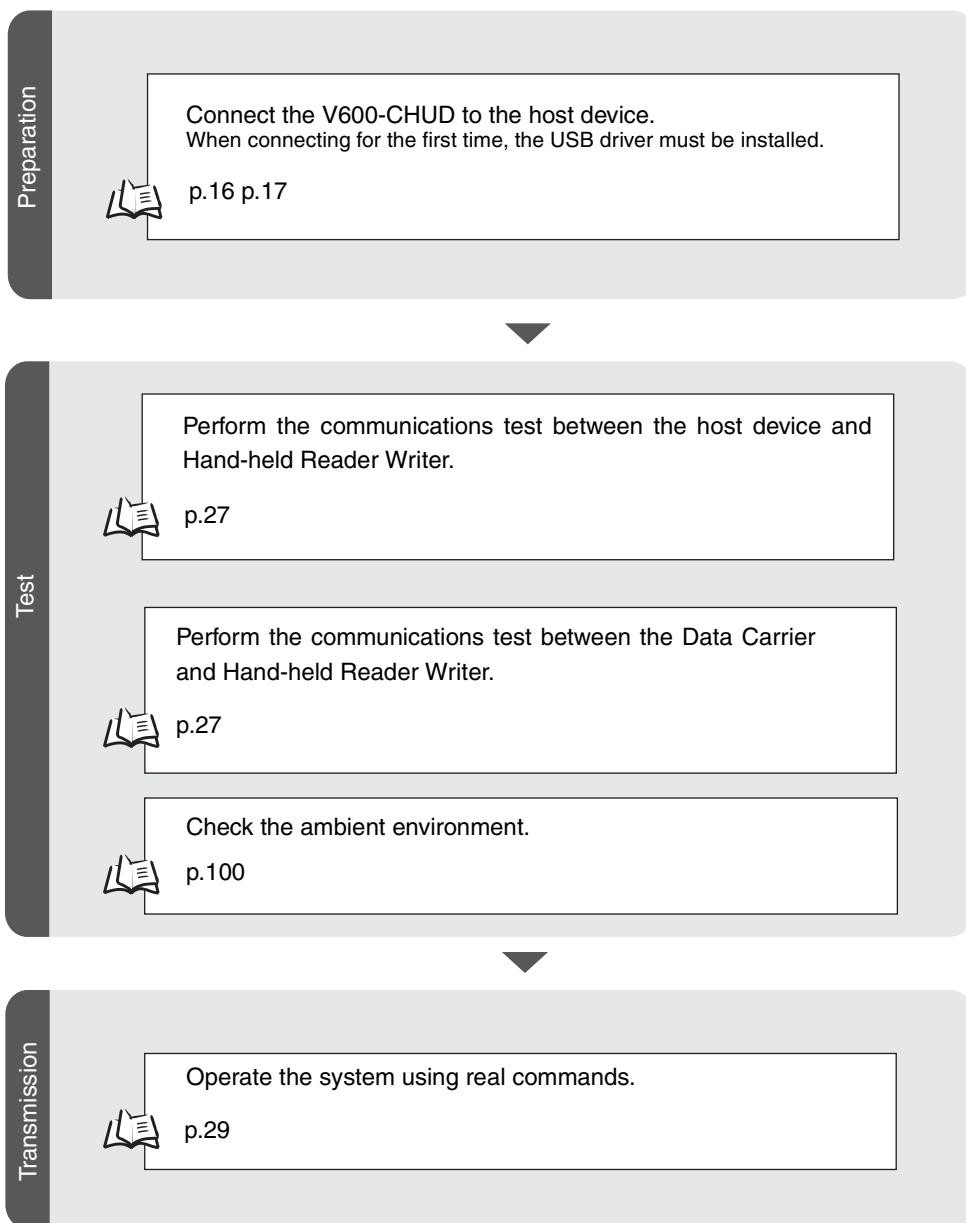

MEMO



## Section 2

# Communications Preparations

☒	Connections	16
☒	Installing the USB Driver	17
☒	Communications Test	26

# Connections

## Connecting the Cable

1. Connect the cable connector to the USB connector on the host device, making sure that the connector is oriented correctly and not inserted at an angle.

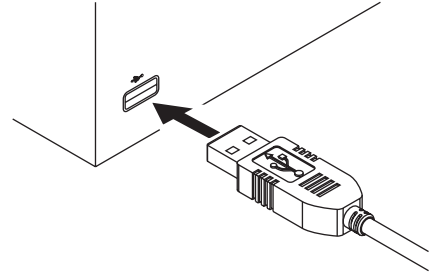

## Removing the Cable

1. Remove the cable.  
Close the software application at the host device and then pull out the connector in a straight line.



CHECK!

If the connector is removed while the software is running at the host device, operation may stop due to a software malfunction error.

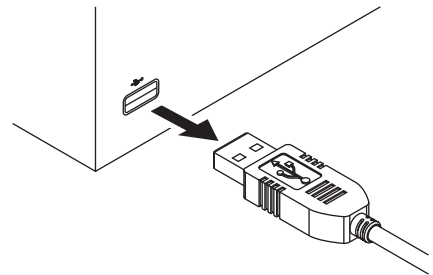

# Installing the USB Driver

When connecting the Hand-held Reader Writer to the host device for the first time, the USB driver must be installed at the host device.

## Install the USB Driver in the Personal Computer

The V600-CHUD supports Windows 2000 and Windows XP operating systems. Install the driver in the host device following the procedure corresponding to the OS being used. Operation on other OS is not supported.

- Windows 2000

1. Turn ON the power to the personal computer and start Windows 2000.

2. Connect the Hand-held Reader Writer to the personal computer.



For details on connection methods, refer to Connections.

The following window will be displayed when the Hand-held Reader Writer is connected.



3. When the following window is displayed, click the **Next** Button.



4. Select **Search for a suitable driver for my device (recommended)** and then click the **Next** Button.



5. Select **Specify a location** and then click the **Next** Button.



6. Click the **Browse** Button, and select the folder in which the downloaded file RFID-Win2kcom.inf is saved.



7. Click the **Next** Button.



The following window will be displayed when software installation is completed.



8. Click the **Finish** Button.

## Checking Installation

Check that the driver is correctly installed.

1. Connect the Hand-held Reader Writer to the personal computer.

2. On the Start Menu, select **Settings - Control Panel - System**.

3. Select the **Device Manager** Button on the Hardware Tab Page.

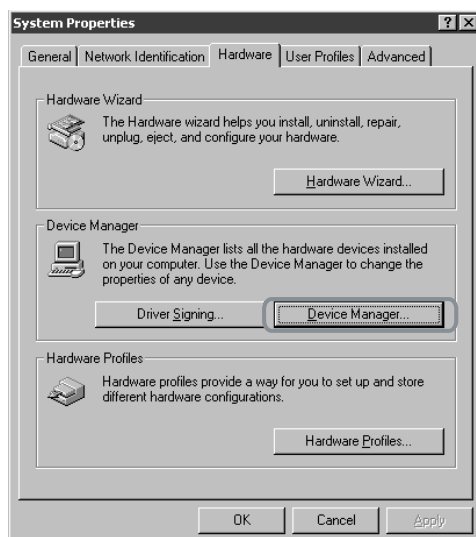

- 4. Select **Ports (COM & LPT)**, and check that *OMRON RFID USB COM* is displayed.  
The driver is correctly installed if this port is displayed.

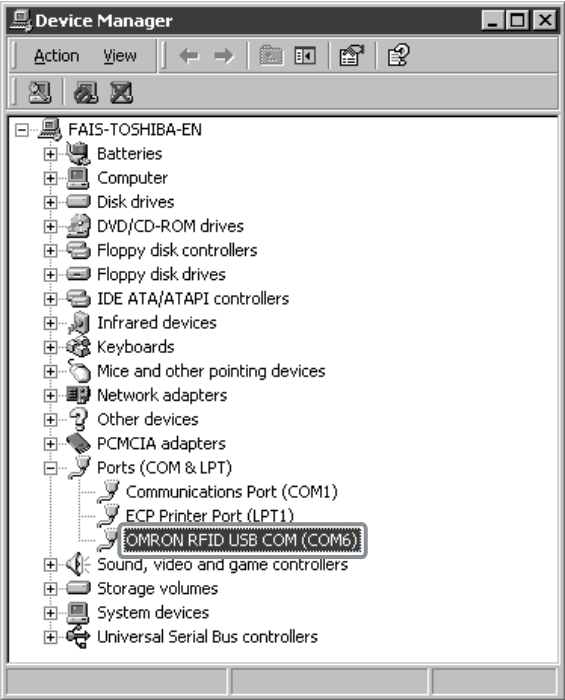

Communications with the Hand-held Reader Writer can be performed with the port number displayed in parentheses after *OMRON RFID USB COM*.

- WindowsXP (SP1)

---

1. Turn ON the power to the personal computer and start Windows XP.

---

2. Connect the Hand-held Reader Writer to the personal computer.



For details on connection methods, refer to Connections.

Wait for the following window to be displayed.

---

3. When the following window is displayed, select **Install from a list or specific location (Advanced)** and click the **Next** Button.





- Click the **Browse** Button, and select the folder in which the downloaded file *RFID-Win2kcom.inf* is saved. Then click the **Next** Button.

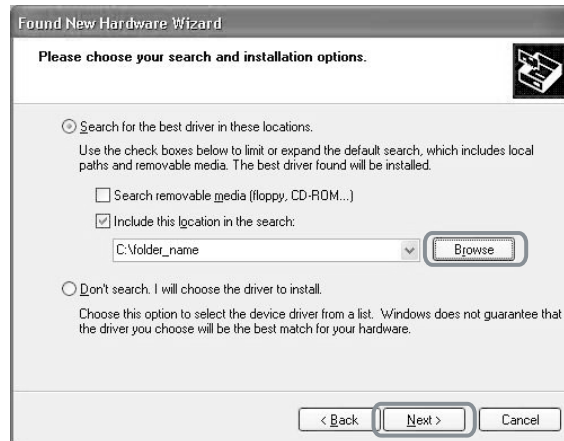

- Click the **Continue Anyway** Button.



When the following window is displayed, installation is completed.



- Click the **Finish** Button.

## Checking Installation

Check that the driver is correctly installed.

1. Connect the Hand-held Reader Writer to the personal computer.

2. On the Start Menu, select **Control Panel - Performance and Maintenance**.

3. Click the **System** Icon.

4. Click the **Device Manager** Button in the Hardware Tab Page.

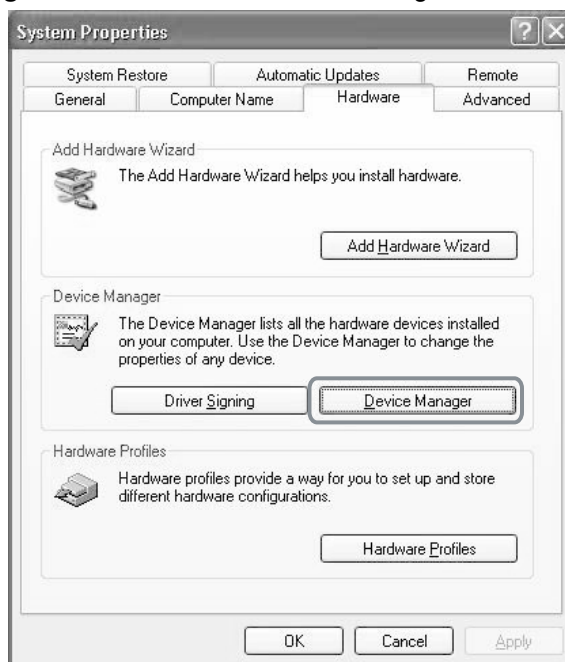

- 5. Select **Ports (COM & LPT)**, and check that *OMRON RFID USB COM* is displayed.  
The driver is correctly installed if this port is displayed.

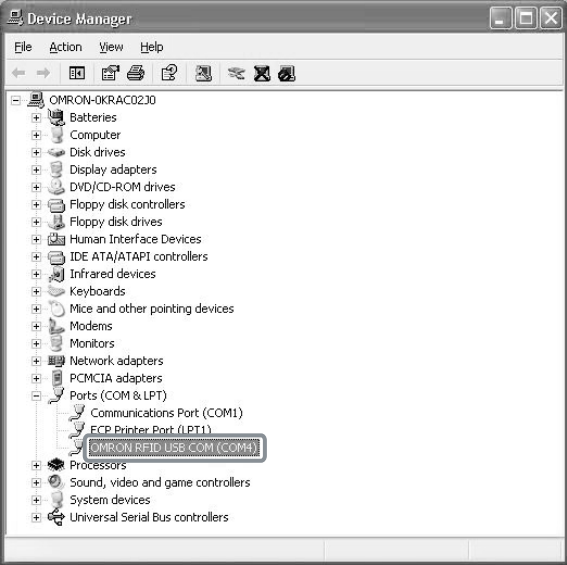

Communications with the Hand-held Reader Writer can be performed with the port number displayed in parentheses after *OMRON RFID USB COM*.

# Communications Test

## Test Run Procedure

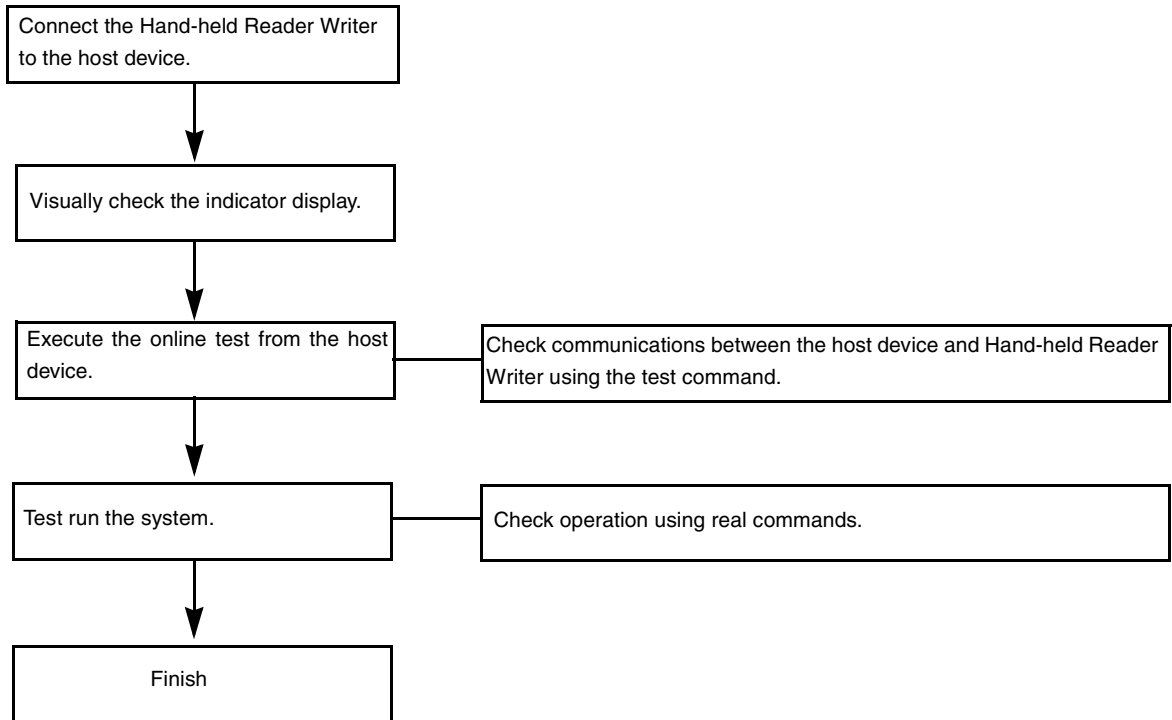

## Communications Test Between Host Device and Hand-held Reader Writer

Use the test command to test communications between the Hand-held Reader Writer and host device. Before performing communications with the Data Carrier, check the Hand-held Reader Writer connections and communications.

1. Send the test command from the host device.

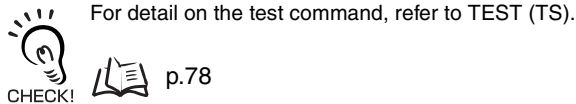

2. If communications is normal, the Hand-held Reader Writer will return the received data.

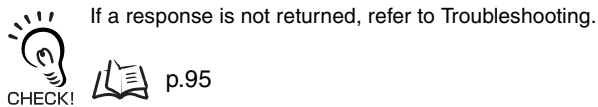

## Communications Test Between the Data Carrier and Hand-held Reader Writer

Use a real command to test communications between the Data Carrier and the Hand-held Reader Writer.

1. Send the auto read command (AR) from the host device.

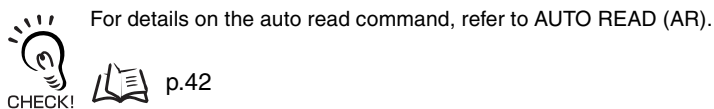

The Hand-held Reader Writer will communicate with the Data Carrier and the operation indicator will flash green.

2. Move the antenna section of the Hand-held Reader Writer close to the Data Carrier.

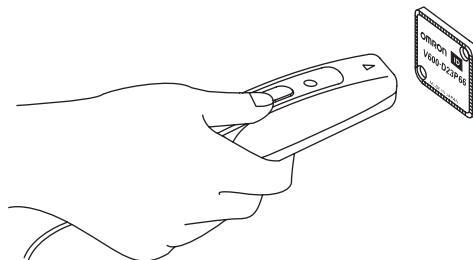

The Hand-held Reader Writer will read the data in the Data Carrier when the Hand-held Reader Writer moves within the communications range. As a result, the operation indicator will be light green and then turn OFF.

MEMO

# Section 3

## Commands

☒ Communications with the Data Carrier	30
☒ Command and Response Format	34
☒ Communications Commands	38
☒ Communications Subcommands	77
☒ Host Commands	78
☒ Evaluation Commands	79
☒ Other Commands	81
☒ End code List	82

# Communications with the Data Carrier

There are 4 types of commands for communicating with the Data Carrier using the Hand-held Reader Writer.

- Normal commands
- Button commands
- Auto commands
- Button auto commands

## Normal Commands

Normal commands are sent from the host device for communications with the Data Carrier, after the antenna end of the Hand-held Reader Writer has been moved close to the Data Carrier.

1. Move the antenna end of the Hand-held Reader Writer close to the Data Carrier.

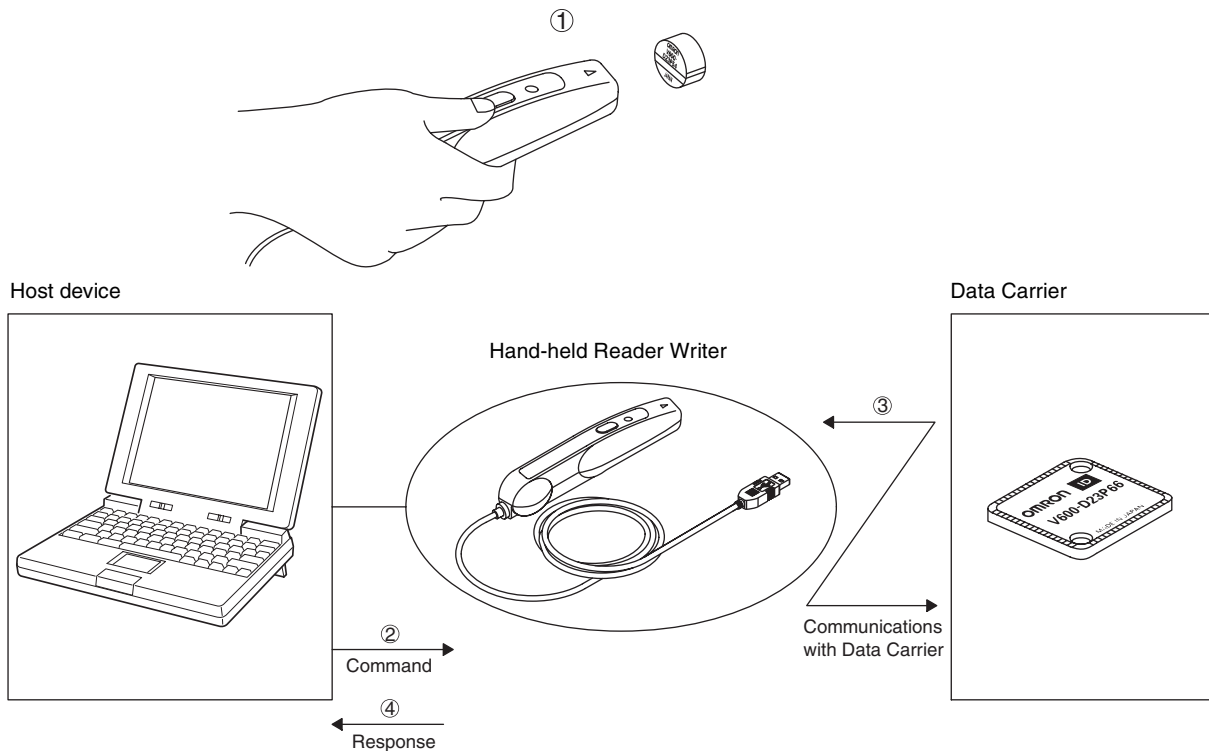

2. Commands are sent from the host device to the Hand-held Reader Writer.
3. The Hand-held Reader Writer communicates with the Data Carrier.
4. A response is returned from the Hand-held Reader Writer to the host device.

If communications are normal, the operation indicator (LED) lights green and then turns OFF.

If the Data Carrier is not detected within the Hand-held Reader Writer's communication area when the command is sent from the host device, a Data Carrier Non-existent Error will occur.

At this time, the operation indicator will flash red.



## Button Commands

Button commands used to perform communications with the Data Carrier are activated when the activate switch is pressed after commands are sent from the host device, and the antenna end of the Hand-held Reader Writer has been moved close to the Data Carrier.

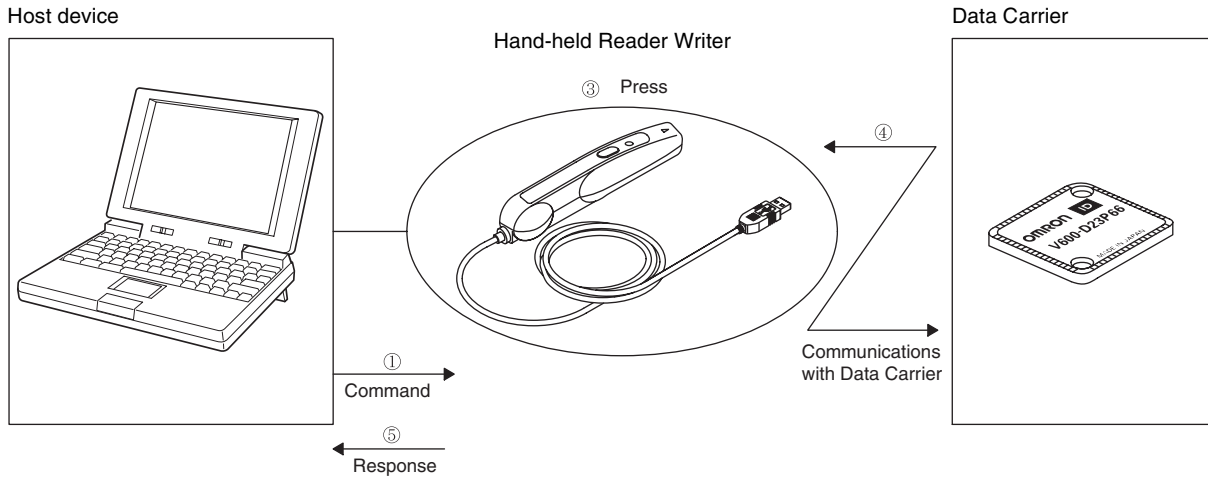

1. A command is sent from the host device to the Hand-held Reader Writer. As a result, the operation indicator will light green.
2. Move the antenna end of the Hand-held Reader Writer close to the Data Carrier.

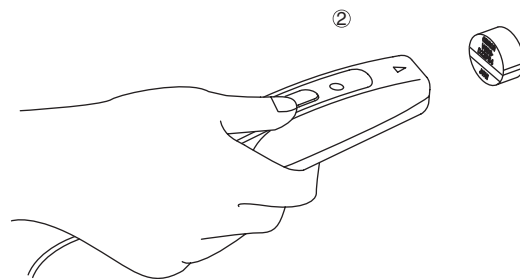

3. Press the Hand-held Reader Writer activate switch.
4. The Hand-held Reader Writer communicates with the Data Carrier.
5. A response is returned to the host device from the Hand-held Reader Writer.

If communications are normal, the operation indicator (LED) lights green and then turns OFF.

If the Data Carrier is not detected within the Hand-held Reader Writer's communication area when the activate switch is pressed, a Data Carrier Non-existent Error will occur.

At this time, the operation indicator will flash red.

## Auto Commands

Auto commands can execute communications with the Data Carrier when the antenna is moved near the front of the Data Carrier after a command is sent from the host device.

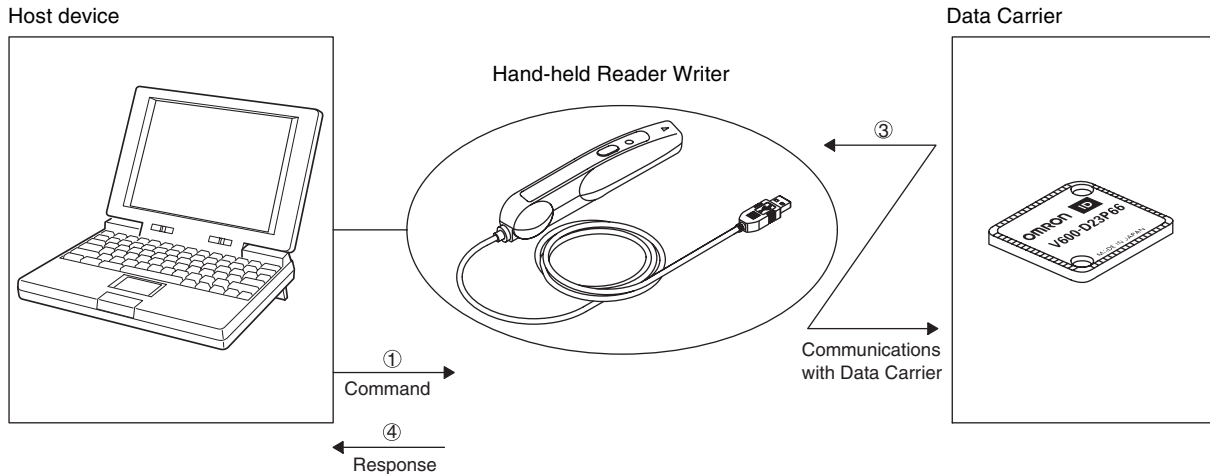

1. A command is sent from the host device to the Hand-held Reader Writer.
2. The Hand-held Reader Writer enters the communication stand-by state with the Data Carrier, and the operation indicator (LED) flashes green.



If the Data Carrier is not detected within one minute of sending the command, a timeout will occur and a Data Carrier Non-existent Error will occur. As a result, the operation indicator will flash red.

3. Communications with the Data Carrier are performed when the antenna end of the Hand-held Reader Writer is moved near the Data Carrier.

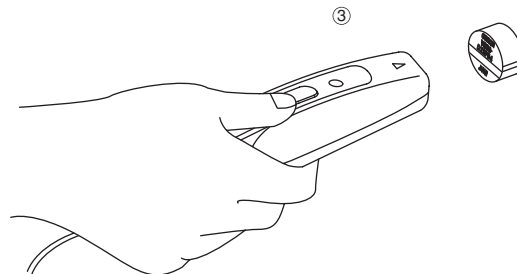

4. A response is returned from the Hand-held Reader Writer to the host device.  
If communications end normally, the operation indicator (LED) lights green and then turns OFF.

## Button Auto Commands

Button auto commands execute auto commands after a command is sent from the host device and the activate switch of the Hand-held Reader Writer is pressed.

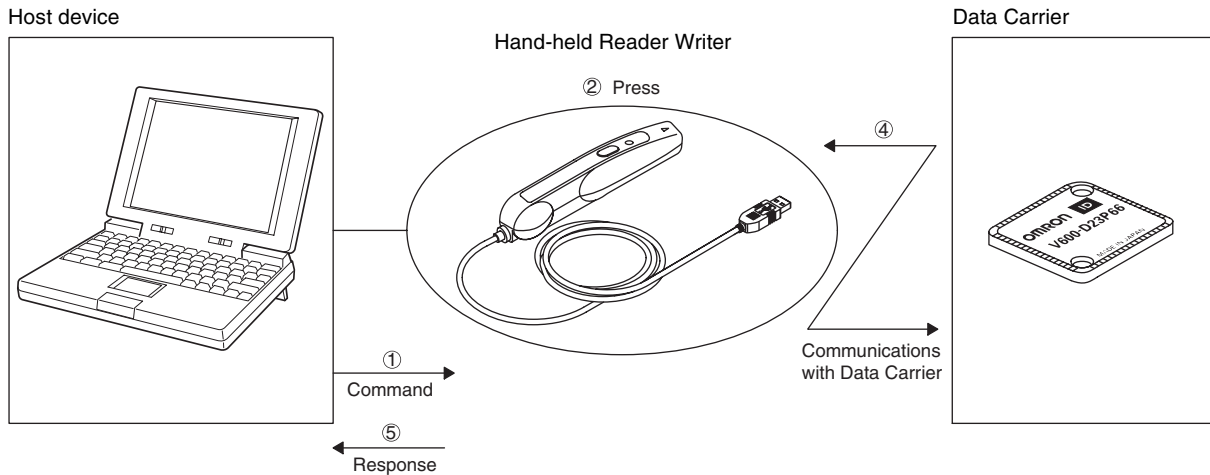

1. A command is sent from the host device to the Hand-held Reader Writer.
2. Press the Hand-held Reader Writer activate switch.
3. The Hand-held Reader Writer enters the communication stand-by state with the Data Carrier, and the operation indicator (LED) flashes green.



CHECK!

If the Data Carrier is not detected within one minute of sending the command, a timeout will occur and a Data Carrier Non-existent Error will occur. As a result, the operation indicator will flash red.

4. Communications with the Data Carrier are performed when the antenna end of the Hand-held Reader Writer is moved near the Data Carrier.

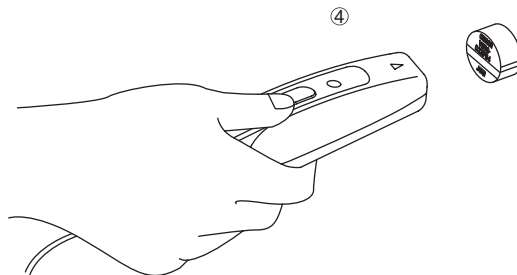

5. A response is returned from the Hand-held Reader Writer to the host device.  
If communications end normally, the operation indicator (LED) lights green and then turns OFF.

# Command and Response Format

The format of commands sent between the host computer and the Hand-held Reader Writer and responses returned from the Hand-held Reader Writer to the host computer is shown below. The command and response both consist of a single frame. The frame (including the terminator) consists of up to 4,106 characters for commands and 4,102 characters for responses.

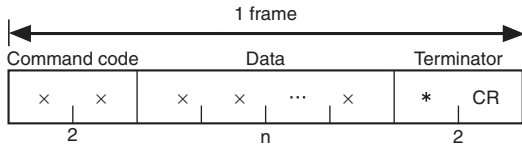

Name	Description
Command code	Command: Contains the two-character code (see page p.36). Response: Contains the same code that was sent with the command.
Data	Contains the details of the command and response, as follows: <ul style="list-style-type: none"> <li>•ASCII/hexadecimal code specification, processing specification, mode specification</li> <li>•Processing area number specification</li> <li>•Processing start address</li> <li>•Number of bytes to be read, write data</li> </ul>
Terminator	Indicates end of command/response.

## Specifying Data Code

Whether the read or write data is treated as an ASCII (or JIS 8) code or hexadecimal code is specified in a command.

### •ASCII (JIS 8 Code)

- One character of ASCII or JIS 8 code data occupies 1 byte (1 address) of the Data Carrier memory.

### •Example of Specifying ASCII Code

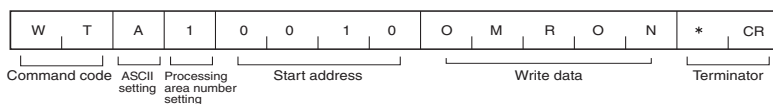

### •Data Carrier

Address			
0010	4	F	"O"
0011	4	D	"M"
0012	5	2	"R"
0013	4	F	"O"
0014	4	E	"N"

•Hexadecimal Code

- One character is treated as a hexadecimal number. Therefore, only numerals 0 through 9 and A to F can be accepted.
- Two characters of data occupy 1 byte (1 address) of the Data Carrier memory. Therefore, specify data in 2-character units (in even numbers) when using a WRITE command. If an odd number of characters is specified by mistake, an error will occur.

•Example of Specifying Hexadecimal Code

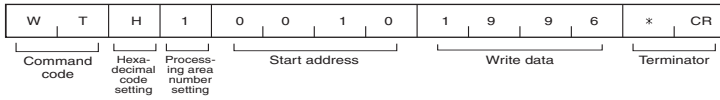

•Data Carrier

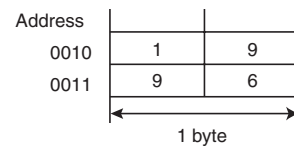

## Command List

Commands can be classified into four major types.

### •Communications Commands

The following commands are used for communications with the Data Carrier.

Command code	Command name	Function	Page
RD	READ	Reads memory data from the Data Carrier.	p.38
WT	WRITE	Writes data to the memory of the Data Carrier.	p.40
AR	AUTO READ	Reads data from the Data Carrier when the Data Carrier is within the communications area.	p.42
AW	AUTO WRITE	Writes data to the memory of the Data Carrier when the Data Carrier is within the communications area.	p.44
BR	BUTTON READ	Reads data from the memory of the Data Carrier when the activate switch is pressed.	p.46
BW	BUTTON WRITE	Writes data to the memory of the Data Carrier when the activate switch is pressed.	p.48
UR	BUTTON AUTO READ	Reads data from the Data Carrier when the Data Carrier enters the communications area after the activate switch is pressed.	p.50
UW	BUTTON AUTO WRITE	Writes data to the memory of the Data Carrier when the Data Carrier enters the communications area after the activate switch is pressed.	p.52
RC	COPY READ	Reads data to be copied using the COPY WRITE command from the Data Carrier.	p.54
WC	COPY WRITE	Writes the data read using the COPY READ command to the Data Carrier.	p.55
XR	EXPANSION DIVIDED READ	Divides and reads up to 2 Kbytes of data from the Data Carrier.	p.56
XW	EXPANSION DIVIDED WRITE	Divides and writes up to 2 Kbytes of data to the Data Carrier.	p.58
NR	EXPANSION DIVIDED AUTO READ	Divides and reads up to 2 Kbytes of data from the Data Carrier when the Data Carrier enters the communications area.	p.60
NW	EXPANSION DIVIDED AUTO WRITE	Divides and writes up to 2 Kbytes of data to the Data Carrier when the Data Carrier enters the communications area.	p.62
rd	EXPANSION BATCH READ	Reads up to 2 Kbytes of data from the Data Carrier in a batch.	p.64
wt	EXPANSION BATCH WRITE	Writes up to 2 Kbytes of data to the Data Carrier in a batch.	p.65
ar	EXPANSION BATCH AUTO READ	Reads up to 2 Kbytes of data from the Data Carrier in a batch when the Data Carrier enters the communications area.	p.66
aw	EXPANSION BATCH AUTO WRITE	Writes up to 2 Kbytes of data to the Data Carrier in a batch when the Data Carrier enters the communications area.	p.67
br	EXPANSION BATCH BUTTON READ	Reads up to 2 Kbytes of data from the Data Carrier in a batch after the activate switch is pressed.	p.68
bw	EXPANSION BATCH BUTTON WRITE	Writes up to 2 Kbytes of data to the Data Carrier in a batch after the activate switch is pressed.	p.69
ur	EXPANSION BATCH BUTTON AUTO READ	Reads up to 2 Kbytes of data from the Data Carrier in a batch when the Data Carrier enters the communications area after the activate switch is pressed.	p.70

Command code	Command name	Function	Page
uw	EXPANSION BATCH BUTTON AUTO WRITE	Writes up to 2 Kbytes of data to the Data Carrier in a batch when the Data Carrier enters the communications area after the activate switch is pressed.	p.71
CW	CALCULATION WRITE	Writes the calculation results for the memory data to the Data Carrier.	p.72
FL	FILL	Writes data for the specified number of write bytes beginning from the write start address specified in the command.	p.73
fl	EXPANSION BATCH FILL	Writes data for the specified number of write bytes beginning from the write start address specified in the command. Up to 2 Kbytes of data can be written in a batch.	p.74
MDC/K	DATA CHECK	Calculates or compares memory check codes in the Data Carrier.	p.75
MDS	OVERWRITE COUNT CONTROL	Controls the number of overwrites for EEPROM Data Carriers.	p.76

### •Communications Subcommands

These commands are used to cancel command execution.

Command code	Command name	Function	Page
AA	COMMAND PRO- CESSING TERMI- NATE	Forcedly ends communications with the Data Carrier.	p.77

### •Host Commands

These commands are used to test communications between the Hand-held Reader Writer and host device.

Command code	Command name	Function	Page
TS	TEST	Confirms the communications status between the Hand-held Reader Writer and host device. The data sent from the host device is returned as is.	p.78
VS	VERSION READ	Reads the Hand-held Reader Writer's model information, software version and software creation date.	p.78

### •Evaluation Commands

These commands are used to investigate the ambient noise conditions.

Command code	Command name	Function	Page
NS	NOISE DETECTION	Detects the noise level.	p.79
EN	ABNORMAL NOISE DETECTION	Detects noise above a specified level.	p.80

# Communications Commands

Details of communications commands used to communicate with the Data Carrier are provided here.

## READ (RD)

This command reads data from the Data Carrier. If the Data Carrier is not in the communications area, an error response (end code: 72 = Data Carrier non-existent) will be returned.

Command

Processing area number: 1

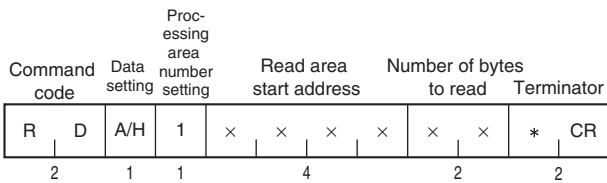

Processing area number: 2

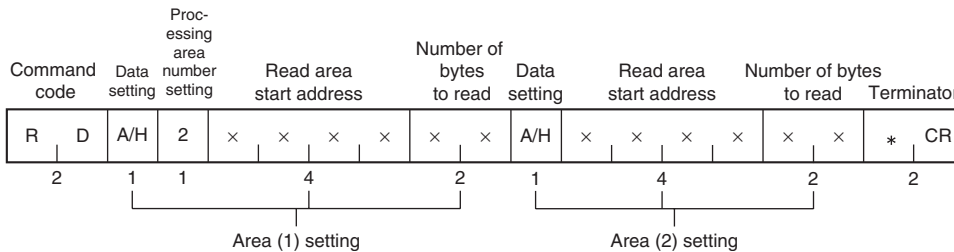

Data setting	Sets the code format used to send responses for read data. A: ASCII H: Hexadecimal code  When multiple processing areas are used, ASCII and hexadecimal code can be specified at the same time within a single command frame.
Processing area number setting	Specifies the processing area number. Setting range: 1 to 9, A (A = 10)
Read area start address	Specifies the start address of the area to be read from the Data Carrier in 4-digit hexadecimal code. Setting range: 0000h to 1FFFh  When multiple processing areas are used, specify the areas in order starting from the smallest address. The same area cannot be specified twice.
Number of bytes to read	Specifies the number of bytes to be read from the Data Carrier in 2-digit hexadecimal code. The maximum number of bytes that can be read at one time is 256 bytes, as follows: •ASCII: 256 bytes (256 characters) •Hexadecimal code: 256 bytes (512 characters)  Setting range: 00h to FFh (00 = 256 bytes)  When multiple processing areas are used, set so that the total number of bytes from all areas to be read is within 256 bytes, as follows: Area (1) bytes + ... + Area (N) bytes ≤ 256 bytes



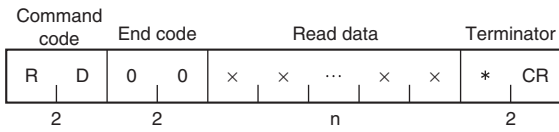

Response

Processing Area Number: 1

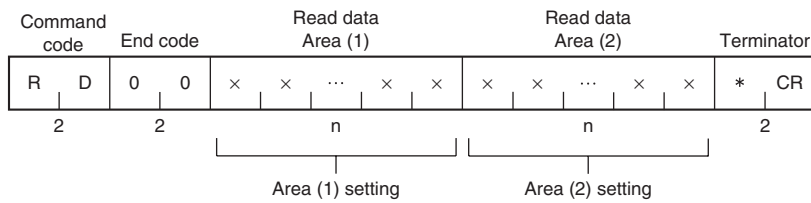

Processing Area Number: 2



End code	<p>Indicates the execution result for the command. The end code 00 indicates normal completion.</p> <p>For details on end codes, refer to End code List.  p.82</p>
Read data	<p>Specifies the data read from the Data Carrier. The characters in ASCII indicate the number of read bytes and the characters in hexadecimal code indicate the number of read bytes x 2.</p>

## WRITE (WT)

This command writes data to the Data Carrier. If the Data Carrier is not in the communications area, an error response (end code: 72 = Data Carrier non-existent) will be returned.

Command

Processing Area Number: 1

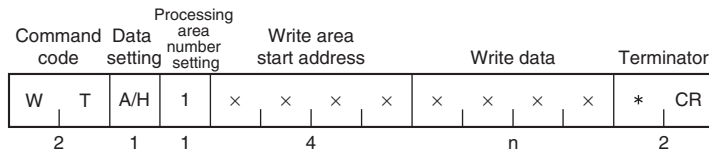

Processing Area Number: 2

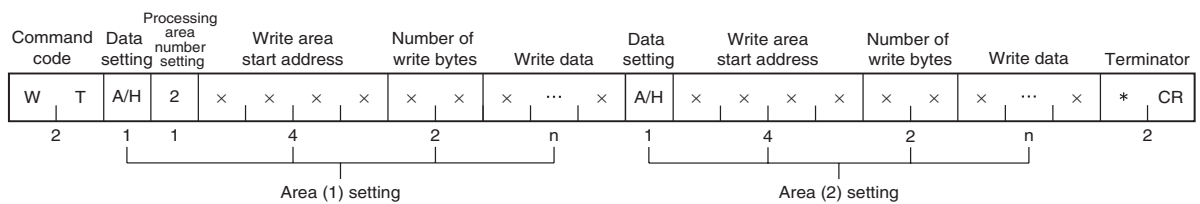

Data setting	<p>Sets the code format used to send responses for read data.</p> <p>A: ASCII H: Hexadecimal code</p> <p>When multiple processing areas are used, ASCII and hexadecimal code can be specified at the same time within a single command frame.</p>
Processing area number setting	<p>Specifies the processing area number.</p> <p>Setting range: 1 to 9, A (A = 10)</p>
Write area start address	<p>Specifies the start address of the area in the Data Carrier to be written to in 4-digit hexadecimal code.</p> <p>Setting range: 0000h to 1FFFh</p> <p>When multiple processing areas are used, specify the areas in order starting from the smallest address. The same area cannot be specified twice.</p>
Number of write bytes	<p>When multiple processing areas are used, specifies the number of bytes to be written to the Data Carrier in 2-digit hexadecimal code. The maximum number of bytes that can be written at one time is 256 bytes, as follows:</p> <ul style="list-style-type: none"> <li>• ASCII: 256 bytes (256 characters)</li> <li>• Hexadecimal code: 256 bytes (512 characters)</li> </ul> <p>Setting range: 01h to FFh</p> <p>When multiple processing areas are used, set so that the total number of bytes to be written for all areas is within 256 bytes, as follows: Area (1) bytes + ... + Area (N) bytes ≤ 256 bytes</p>
Write data	<p>Specifies the write data from the Data Carrier.</p> <p>The characters in ASCII indicate the number of write bytes and the characters in hexadecimal code indicate the number of write bytes x 2.</p>

Response

Command code    End code    Terminator

W	T	0	0	*	CR
2		2		2	

End code	<p>Indicates the execution result for the command. The end code 00 indicates normal completion.</p> <p>For details on end codes, refer to End code List.  p.82</p>
----------	---

## AUTO READ (AR)

This command reads data from the Data Carrier when the Data Carrier enters the communications area. The Hand-held Reader Writer responds when the communication between the Hand-held Reader Writer and Data Carrier has ended.

Command

Processing Area Number: 1

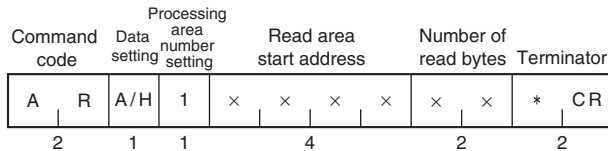

Processing Area Number: 2

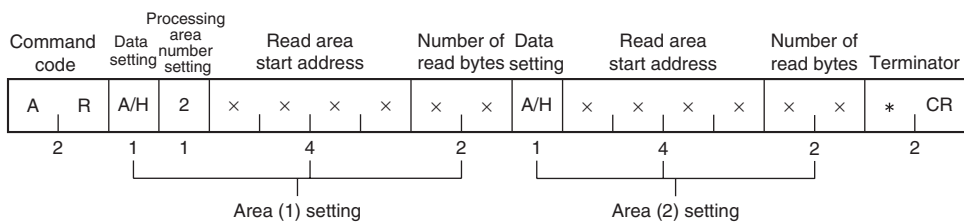

Data setting	<p>Specifies the code format used to send responses for read data.</p> <p>A: ASCII H: Hexadecimal code</p> <p>When multiple processing areas are used, ASCII and hexadecimal code can be specified at the same time within a single command frame.</p>
Processing area number setting	<p>Specifies the processing area number.</p> <p>Setting range: 1 to 9, A (A = 10)</p>
Read area start address	<p>Specifies the start address of the area in the Data Carrier to be read from in 4-digit hexadecimal code.</p> <p>Setting range: 0000h to 1FFFh</p> <p>When multiple processing areas are used, specify the areas in order starting from the smallest address. The same area cannot be specified twice.</p>
Number of read bytes	<p>When multiple processing areas are used, specifies the number of bytes to be read from the Data Carrier in 2-digit hexadecimal code.</p> <p>The maximum number of bytes that can be read at one time is 256 bytes.</p> <ul style="list-style-type: none"> <li>•ASCII: 256 bytes (256 characters)</li> <li>•Hexadecimal code: 256 bytes (512 characters)</li> </ul> <p>Setting range: 00h to FFh (00 = 256 bytes)</p> <p>When multiple processing areas are used, set so that the total number of bytes to be read for all areas is within 256 bytes, as follows:</p> <p style="text-align: center;">Area (1) bytes +...+ Area (N) bytes ≤ 256 bytes</p>

Response

Processing Area Number: 1

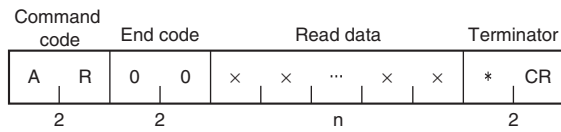

Processing Area Number: 2

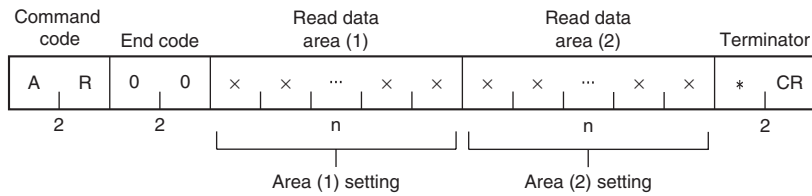

End code	<p>Indicates the execution result for the command. The end code 00 indicates normal completion.</p> <p>For details on end codes, refer to End code List.  p.82</p>
Read data	<p>Specifies the data read from the Data Carrier. The characters in ASCII indicate the number of read bytes and the characters in hexadecimal code indicate the number of read bytes x 2.</p>

## AUTO WRITE (AW)

This command writes data to the Data Carrier when the Data Carrier enters the communications area. The Hand-held Reader Writer responds when communications between the Hand-held Reader Writer and Data Carrier have ended.

Command

Processing Area Number: 1

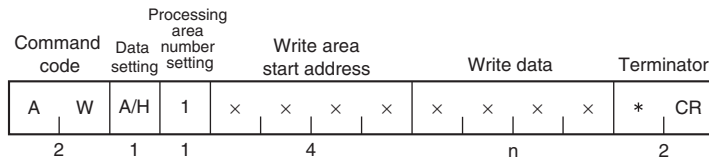

Processing Area Number: 2

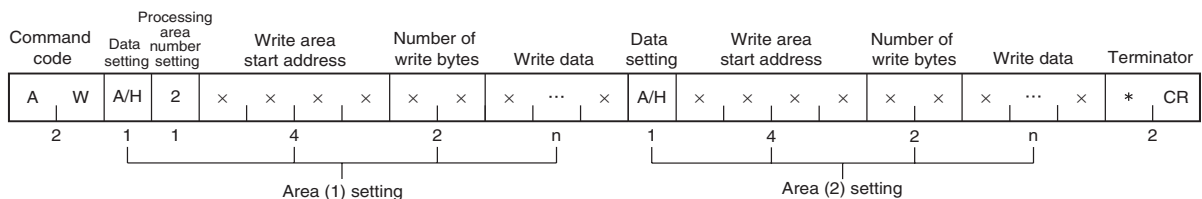

Data setting	<p>Sets the code format used to send responses for read data.</p> <p>A: ASCII H: Hexadecimal code</p> <p>When multiple processing areas are used, ASCII and hexadecimal code can be specified at the same time within a single command frame.</p>
Processing area number setting	<p>Specifies the processing area number.</p> <p>Setting range: 1 to 9, A (A = 10)</p>
Write area start address	<p>Specifies the start address of the area in the Data Carrier to be written to in 4-digit hexadecimal code.</p> <p>Setting range: 0000h to 1FFFh</p> <p>When multiple processing areas are used, specify the areas in order starting from the smallest address. The same area cannot be specified twice.</p>
Number of write bytes	<p>When multiple processing areas are used, specifies the number of bytes to be written to the Data Carrier in 2-digit hexadecimal.</p> <p>The maximum number of bytes that can be written at one time is 256 bytes.</p> <ul style="list-style-type: none"> <li>•ASCII: 256 bytes (256 characters)</li> <li>•Hexadecimal code: 256 bytes (512 characters)</li> </ul> <p>Setting range: 01h to FFh</p> <p>When multiple processing areas are used, set so that the total number of bytes to be written for all areas is within 256 bytes, 6 bytes, as follows: Area (1) bytes +...+ Area (N) bytes ≤ 256 bytes</p>
Write data	<p>Indicates the data to be written to the Data Carrier.</p> <p>The characters in ASCII indicate the number of write bytes and the characters in hexadecimal code indicate the number of write bytes × 2</p>

Response

Command code    End code    Terminator

A	W	0	0	*	CR
2		2		2	

End code	<p>Indicates the execution result for the command. The end code 00 indicates normal completion.</p> <p>For details on end codes, refer to NEnd code List.  p.82</p>
----------	--

## BUTTON READ (BR)

After this command is received by the Hand-held Reader Writer, data is read from the Data Carrier by pressing the activate switch. If the activate switch is pressed and the Data Carrier is not in communications range, an error response (end code: 72 = Data Carrier non-existent) will be returned.

Command

Processing Area Number: 1

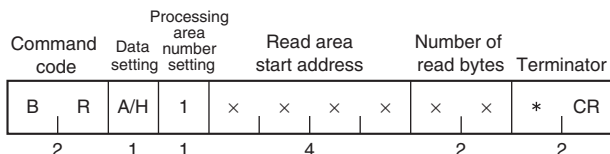

Processing Area Number: 2

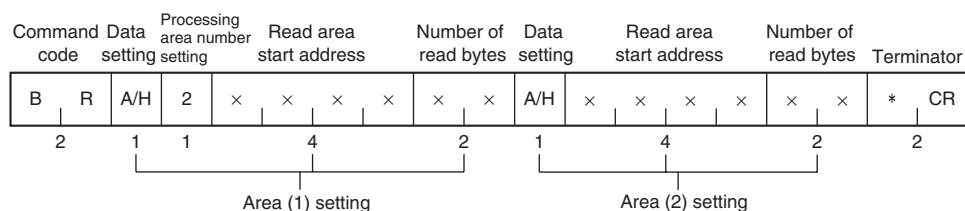

Data setting	<p>Sets the code format used to send responses for read data.</p> <p>A: ASCII H: Hexadecimal code</p> <p>When multiple processing areas are used, ASCII and hexadecimal code can be specified at the same time within a single command frame.</p>
Processing area number setting	<p>Specifies the processing area number.</p> <p>Setting range: 1 to 9, A (A = 10)</p>
Read area start address	<p>Specifies the start address of the area in the Data Carrier to be read from in 4-digit hexadecimal code.</p> <p>Setting range: 0000h to 1FFFh</p> <p>When multiple processing areas are used, specify the areas in order starting from the smallest address. The same area cannot be specified twice.</p>
Number of read bytes	<p>Specifies the number of bytes to be read from the Data Carrier in 2-digit hexadecimal. The maximum number of bytes that can be read at one time is 256 bytes.</p> <ul style="list-style-type: none"> <li>•ASCII: 256 bytes (256 characters)</li> <li>•Hexadecimal code: 256 bytes (512 characters)</li> </ul> <p>Setting range: 00h to FFh (00 = 256 bytes)</p> <p>When multiple processing areas are used, set so that the total number of bytes to be read for all areas is within 256 bytes, as follows:                      Area (1) bytes +...+ Area (N) bytes ≤ 256 bytes</p>



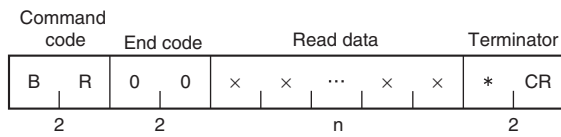

Response

Processing Area Number: 1

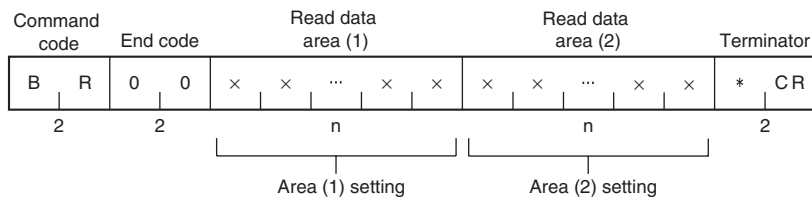

Processing Area Number: 2



End code	<p>Indicates the execution result for the command. The end code 00 indicates normal completion.</p> <p>For details on end codes, refer to End code List.  p.82</p>
Read data	<p>Indicates the data read from the Data Carrier. The characters in ASCII indicate the number of read bytes and the characters in hexadecimal code indicate the number of read bytes x 2.</p>

## BUTTON WRITE (BW)

After this command is received by the Hand-held Reader Writer, data is written to the Data Carrier by pressing the activate switch. If the activate switch is pressed and the Data Carrier is not in communications range, an error response (end code: 72 = Data Carrier non-existent) will be returned.

Command

Processing Area Number: 1

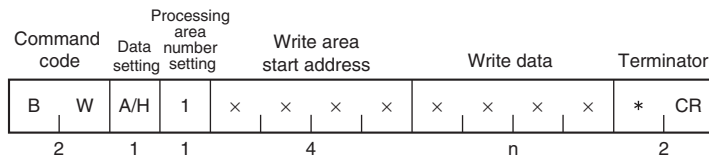

Processing Area Number: 2

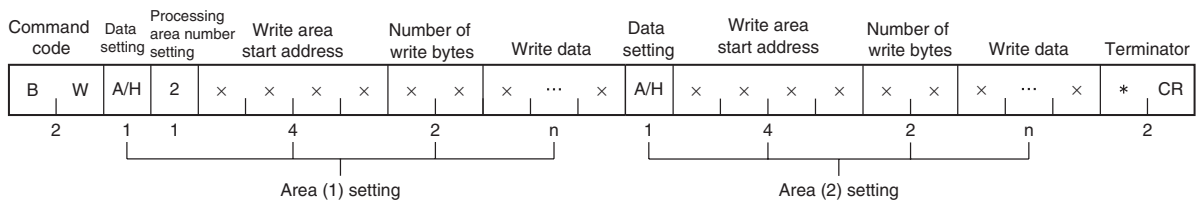

Data setting	<p>Sets the code format used to send responses for read data.</p> <p>A: ASCII H: Hexadecimal code</p> <p>When multiple processing areas are used, ASCII and hexadecimal code can be specified at the same time within a single command frame.</p>
Processing area number setting	<p>Specifies the processing area number.</p> <p>Setting range: 1 to 9, A (A = 10)</p>
Write area start address	<p>Specifies the start address of the area in the Data Carrier to be written to in 4-digit hexadecimal code.</p> <p>Setting range: 0000h to 1FFFh</p> <p>When multiple processing areas are used, specify the areas in order starting from the smallest address. The same area cannot be specified twice.</p>
Number of write bytes	<p>When multiple processing areas are used, specifies the number of bytes to be written to the Data Carrier in 2-digit hexadecimal.</p> <p>The maximum number of bytes that can be written at one time is 256 bytes.</p> <ul style="list-style-type: none"> <li>•ASCII: 256 bytes (256 characters)</li> <li>•Hexadecimal code: 256 bytes (512 characters)</li> </ul> <p>Setting range: 01h to FFh</p> <p>When multiple processing areas are used, set so that the total number of bytes to be written for all areas is within 256 bytes, as follows: Area (1) bytes +...+ Area (N) bytes ≤ 256 bytes</p>
Write data	<p>Indicates the data to be written to the Data Carrier.</p> <p>The characters in ASCII indicate the number of write bytes and the characters in hexadecimal code indicate the number of write bytes x 2.</p>

Response

Command  
code      End code      Terminator

B	W	0	0	*	CR
2		2		2	

End code	<p>Indicates the execution result for the command. The end code 00 indicates normal completion.</p> <p>For details on end codes, refer to End code List.  p.82</p>
----------	---

## BUTTON AUTO READ (UR)

After this command is received by the Hand-held Reader Writer, data will be read from the Data Carrier after the activate switch is pressed and the Hand-held Reader Writer is close to the Data Carrier. The Hand-held Reader Writer responds when communications between the Hand-held Reader Writer and Data Carrier have ended.

Command

Processing Area Number: 1

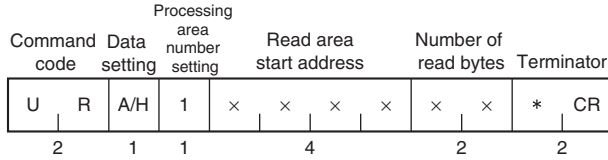

Processing Area Number: 2

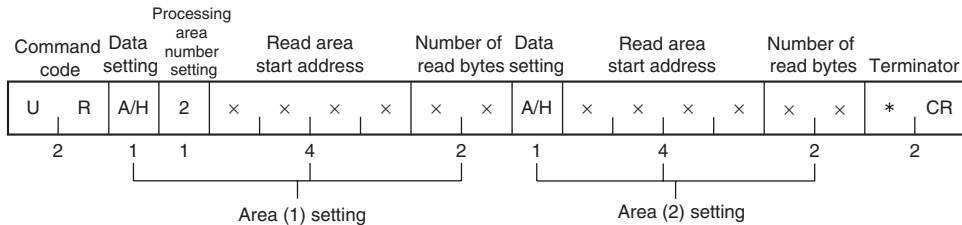

Data setting	<p>Sets the code format used to send responses for read data.</p> <p>A: ASCII H: Hexadecimal code</p> <p>When multiple processing areas are used, ASCII and hexadecimal code can be specified at the same time within a single command frame.</p>
Processing area number setting	<p>Specifies the processing area number.</p> <p>Setting range: 1 to 9, A (A = 10)</p>
Read area start address	<p>Specifies the start address of the area in the Data Carrier to be read from in 4-digit hexadecimal code.</p> <p>Setting range: 0000h to 1FFFh</p> <p>When multiple processing areas are used, specify the areas in order starting from the smallest address. The same area cannot be specified twice.</p>
Number of read bytes	<p>Specifies the number of bytes to be read from the Data Carrier in 2-digit hexadecimal.</p> <p>The maximum number of bytes that can be read at one time is 256 bytes.</p> <ul style="list-style-type: none"> <li>•ASCII: 256 bytes (256 characters)</li> <li>•Hexadecimal code: 256 bytes (512 characters)</li> </ul> <p>Setting range: 00h to FFh (00 = 256 bytes)</p> <p>When multiple processing areas are used, set so that the total number of bytes to be read for all areas is within 256 bytes, as follows: Area (1) bytes +...+ Area (N) bytes ≤ 256 bytes</p>

Response

Processing Area Number: 1

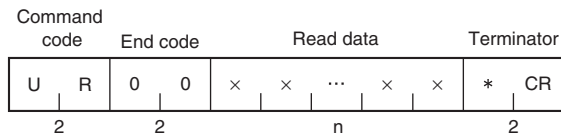

Processing Area Number: 2

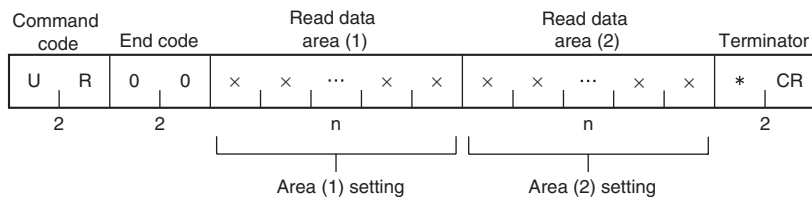

End code	<p>Indicates the execution result for the command. The end code 00 indicates normal completion.</p> <p>For details on end codes, refer to End code List.  p.82</p>
Read data	<p>Indicates the data read from the Data Carrier. The characters in ASCII indicate the number of read bytes and the characters in hexadecimal code indicate the number of read bytes x 2.</p>

## BUTTON AUTO WRITE (UW)

After this command is received by the Hand-held Reader Writer, data will be written to the Data Carrier after the activate switch is pressed and the Hand-held Reader Writer is close to the Data Carrier. The Hand-held Reader Writer responds when communications between the Hand-held Reader Writer and Data Carrier have ended.

Command

Processing Area Number: 1

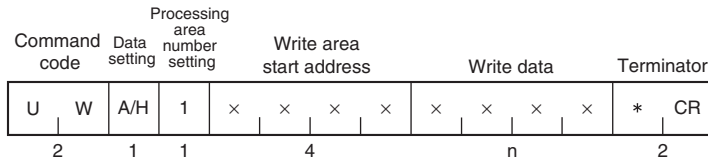

Processing Area Number: 2

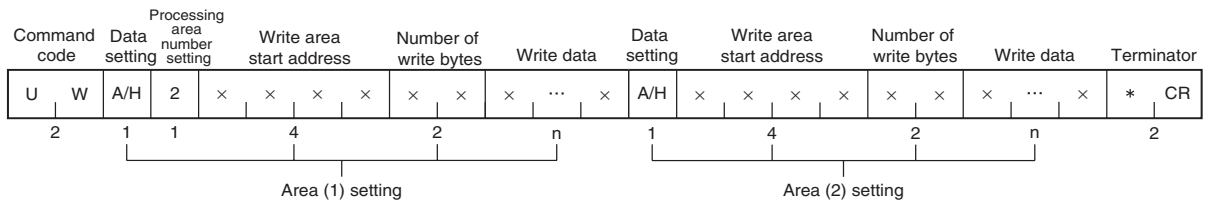

Data setting	Sets the code format used to send responses for read data. A: ASCII H: Hexadecimal code  When multiple processing areas are used, ASCII and hexadecimal code can be specified at the same time within a single command frame.
Processing area number setting	Specifies the processing area number. Setting range: 1 to 9, A (A = 10)
Write area start address	Specifies the start address of the area in the Data Carrier to be written to in 4-digit hexadecimal code. Setting range: 0000h to 1FFFh  When multiple processing areas are used, specify the areas in order starting from the smallest address. The same area cannot be specified twice.
Number of write bytes	When multiple processing areas are used, specifies the number of bytes to be written to the Data Carrier in 2-digit hexadecimal. The maximum number of bytes that can be written at one time is 256 bytes. •ASCII: 256 bytes (256 characters) •Hexadecimal code: 256 bytes (512 characters) Setting range: 01h to FFh  When multiple processing areas are used, set so that the total number of bytes to be written for all areas is within 256 bytes, as follows: Area (1) bytes +...+ Area (N) bytes ≤ 256 bytes
Write data	Indicates the data to be written to the Data Carrier. The characters in ASCII indicate the number of write bytes and the characters in hexadecimal code indicate the number of write bytes x 2.

Response

Command  
code    End code    Terminator

U	W	0	0	*	CR
2		2		2	

End code	<p>Indicates the execution result for the command. The end code 00 indicates normal completion.</p> <p>For details on end codes, refer to End code List.  p.82</p>
----------	---

## COPY READ (RC)

This command reads data to be copied using the COPY WRITE (WC) command.  
A response is not sent for read data.

### Command

Command code	Data setting	Processing area number setting	Read area start address				Number of read bytes				Terminator		
R	C	H	1	x	x	x	x	x	x	x	*	CR	
2		1	1	0 or 4				0 or 4				2	

Data setting	Always H.
Processing area number setting	Always 1.
Read area start address	Specifies the start address of the area in the Data Carrier to be read from in 4-digit hexadecimal code (can be omitted). Setting range: 0000h to 1FFFh (when omitted, all areas in the Data Carrier are read)  Note: If omitting the start address, also omit the number of read bytes. All areas of an 8-Kbytes Data Carrier cannot be copied.
Number of read bytes	Specifies the number of bytes to be read from the Data Carrier in 4-digit hexadecimal. Setting range: 0001h to 0800h

### Response

Command code	End code	Terminator
R	0	0
C	*	CR
2		2

End code	Indicates the execution result for the command. The end code 00 indicates normal completion.  For details on end codes, refer to End code List.  p.82
----------	--



The COPY READ command can be executed more than once for data that has already been copied. If the copy operation fails, however, the copied data that was held will be deleted.

CHECK!



## COPY WRITE (WC)

This command writes data to the Data Carrier that was read using the COPY READ (RC) command. The Hand-held Reader Writer responds when communications between the Hand-held Reader Writer and Data Carrier have ended.

### Command

Command code	Data setting	Processing area number	Terminator
W	C	H 1	* CR
2	1	1	2

Data setting	Always H.
Processing area number setting	Always 1.

### Response

Command code	End code	Terminator
W	C 0 0	* CR
2	2	2

End code	<p>Indicates the execution result for the command. The end code 00 indicates normal completion.</p> <p>For details on end codes, refer to End code List.  p.82</p>
----------	---

## EXPANSION DIVIDED READ (XR)

This command divides and reads up to 2 Kbytes of data. If the Data Carrier is not in communications range, an error response (end code: 72 = Data Carrier non-existent) will be returned. The host device cannot send commands to the Hand-held Reader Writer until all the responses have been received.

### Command

Command code		Data setting	Processing area number setting	Read area start address				Number of read bytes				Terminator	
X	R	A/H	1	x	x	x	x	x	x	x	x	*	CR
2		1	1	4				4				2	

Data setting	Sets the code format used to send responses for read data. A: ASCII H: Hexadecimal code
Processing area number setting	Always 1.
Read area start address	Specifies the start address of the area in the Data Carrier to be read from in 4-digit hexadecimal code. Setting range: 0000h to 1FFFh
Number of read bytes	Specifies the number of bytes to be read from the Data Carrier in 4-digit hexadecimal. The maximum number of bytes that can be read at one time is 2,048 bytes. Setting range: 0001h to 0800h •ASCII: 2,048 bytes (2,048 characters) •Hexadecimal code: 2,048 bytes (4,096 characters)

### Response

When the read data is within 250 characters.

Command code		End code		Read data				Terminator	
X	R	0	0	x	x	...	x	x	* CR
2		2		n				2	

End code	Indicates the execution result for the command. The end code 00 indicates normal completion.  For details on end codes, refer to End code List.  p.82
Read data	Indicates the data read from the Data Carrier. The characters in ASCII indicate the number of read bytes and the characters in hexadecimal code indicate the number of read bytes x 2.

When the read data is 251 characters or higher.

The data received from the host device is divided into frames according to the delimiters (CR), as shown in the following diagram.

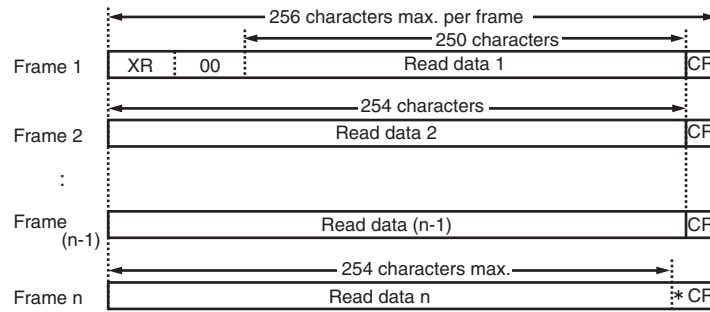

Communications Procedure

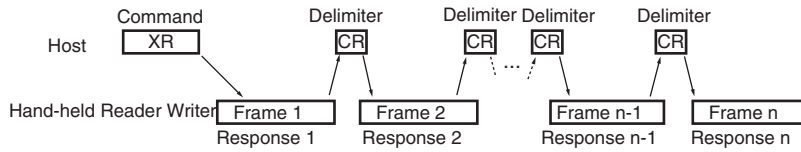

## EXPANSION DIVIDED WRITE (XW)

Divides and writes up to 2 Kbytes of data. If the Data Carrier is not in communications range, an error response (end code: 72 = Data Carrier non-existent) will be returned.

The host device cannot send commands to the Hand-held Reader Writer until all the responses have been received.

Command

Frame 1

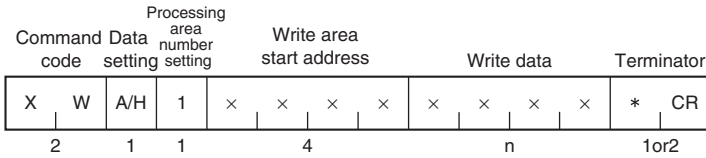

Data setting	Specifies the code format used to send write data to the Data Carrier. A: ASCII H: Hexadecimal code
Processing area number setting	Always 1.
Write area start address	Specifies the start address of the area to be written to in 4-digit hexadecimal. Setting range: 0000h to 1FFFh
Write data	Indicates the data to be written to the Data Carrier. Data can be between 0 and 257 characters.
Terminator	Indicates the end of the frame. CR: Succeeding frame *CR: No succeeding frame

Frames 2 to N

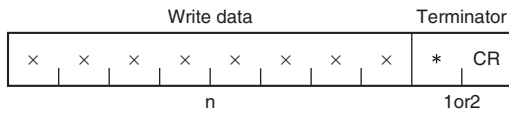

Write data	Indicates the data to be written to the Data Carrier. Data can be between 0 and 265 characters.
Terminator	Indicates the end of the frame. CR: Succeeding frame *CR: No succeeding frame

Response

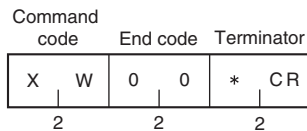

End code	Indicates the execution result for the command. The end code 00 indicates normal completion.  For details on end codes, refer to End code List.  p.82
----------	--

### •Frame Division Method

If the command length is longer than 266 characters, divide the data into separate frames before sending as follows:

#### Frame Division Method

1. Divide the data into frames each with 266 characters max.
2. Use the final terminator (\* CR) for the last frame (frame n) only. Use the delimiter (CR) at the end of other frames.
3. Be sure to include the command code, data setting, processing area number setting, and start address in the first frame (frame 1). If any of these parameters is omitted, a command input error will occur. The write data can be omitted.
4. Make sure that data is divided correctly without any single frames containing AA\*CR or XZ\*CR.

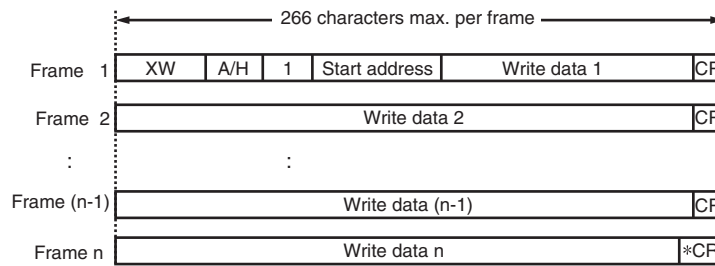

#### Communications Procedure

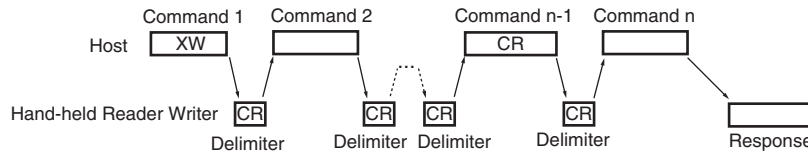

## EXPANSION DIVIDED AUTO READ (NR)

This command divides and reads up to 2 Kbytes of data from the Data Carrier when the Hand-held Reader Writer is moved close to the Data Carrier. The Hand-held Reader Writer responds when communications between the Hand-held Reader Writer and Data Carrier have ended. The host device cannot send commands to the Hand-held Reader Writer until all the responses have been received.

Command

Command code		Data setting	Processing area number setting	Read area start address				Number of read bytes				Terminator	
N	R	A/H	1	x	x	x	x	x	x	x	x	*	CR
2		1	1	4				4				2	

Data setting	Sets the code format used to send responses for read data. A: ASCII H: Hexadecimal code
Processing area number setting	Always 1.
Read area start address	Specifies the start address of the area in the Data Carrier to be read from in 4-digit hexadecimal code. Setting range: 0000h to 1FFFh
Number of read bytes	Specifies the number of bytes to be read from the Data Carrier in 4-digit hexadecimal. The maximum number of bytes that can be read at one time is 2,048 bytes. Setting range: 0001h to 0800h •ASCII: 2,048 bytes (2,048 characters) •Hexadecimal code: 2,048 bytes (4,096 characters)

Response

When the read data is within 250 characters.

Command code		End code		Read data				Terminator	
N	R	0	0	x	x	...	x	x	* CR
2		2		n				2	

End code	Indicates the execution result for the command. The end code 00 indicates normal completion.  For details on end codes, refer to End code List.  p.82
Read data	Indicates the data read from the Data Carrier. The characters in ASCII indicate the number of read bytes and the characters in hexadecimal code indicate the number of read bytes x 2.

When the read data is 251 characters or higher.

The data received from the host device is divided into frames according to the delimiters (CR), as shown in the following diagram.

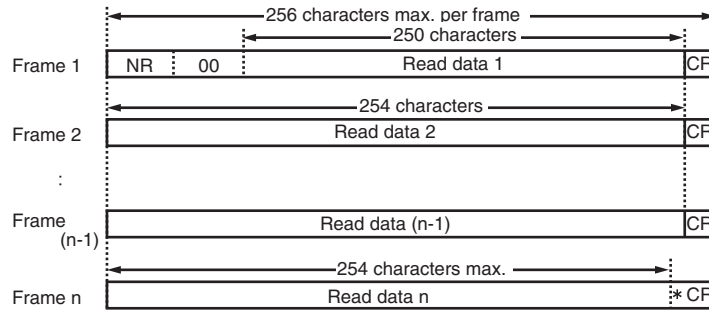

Communications Procedure

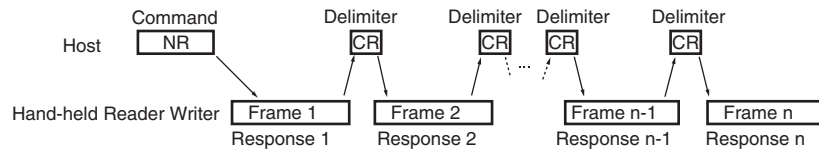

## EXPANSION DIVIDED AUTO WRITE (NW)

This command divides and writes up to 2 Kbytes of data to the Data Carrier when the Hand-held Reader Writer is moved close to the Data Carrier. The Hand-held Reader Writer responds when communications between the Hand-held Reader Writer and Data Carrier have ended. The host device cannot send commands to the Hand-held Reader Writer until all the responses have been received

Command

Frame 1

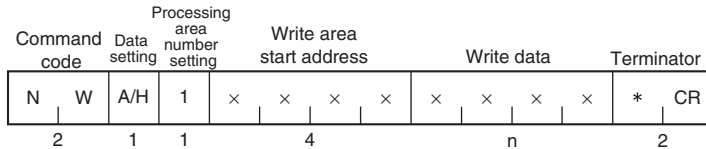

Data setting	Specifies the code format used to send write data to the Data Carrier. A: ASCII H: Hexadecimal code
Processing area number setting	Always 1.
Write area start address	Specifies the start address of the area to be written to in 4-digit hexadecimal. Setting range: 0000h to 1FFFh
Write data	Indicates the data to be written to the Data Carrier. Data can be between 0 and 257 characters.
Terminator	Indicates the end of the frame. CR: Succeeding frame *CR: No succeeding frame

Frames 2 to n

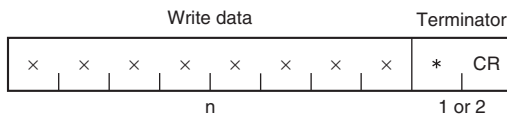

Write data	Indicates the data to be written to the Data Carrier. Data can be between 0 and 265 characters.
Terminator	Indicates the end of the frame. CR: Succeeding frame *CR: No succeeding frame

Response

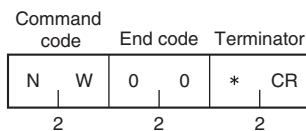

End code	Indicates the execution result for the command. The end code 00 indicates normal completion.  For details on end codes, refer to End code List.  p.82
----------	--



•Frame Division Method

If the command length is longer than 266 characters, divide the data into separate frames before sending, as follows:

Frame Division Method

1. Divide the data into frames each with 266 characters max.
2. Use the final terminator (\* CR) for the last frame (frame n) only. Use the delimiter (CR) at the end of other frames.
3. Be sure to include the command code, data setting, processing area number setting, and start address in the first frame (frame 1). If any of these parameters is omitted, a command input error will occur. The write data can be omitted.
4. Make sure that data is divided correctly without any single frames containing AA\*CR or XZ\*CR.

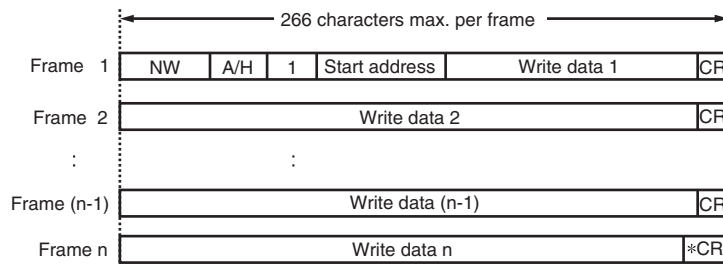

Communications Procedure

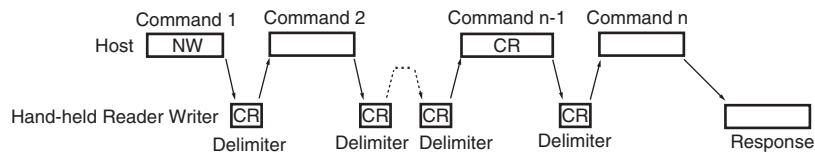

## EXPANSION BATCH READ (rd)

This command reads up to 2 Kbytes of data from the Data Carrier in a batch. If the Data Carrier is not in communications range, an error response (end code: 72 = Data Carrier non-existent) will be returned.

### Command

Command code	Data setting	Processing area number setting	Read area start address	Number of read bytes	Terminator
r	d	A/H	1	x x x x	x x x x
2		1	1	4	4
					* CR
					2

Data setting	Sets the code format used to send responses for read data. A: ASCII H: Hexadecimal code
Processing area number setting	Always 1.
Read area start address	Specifies the start address of the area in the Data Carrier to be read from in 4-digit hexadecimal code. Setting range: 0000h to 1FFFh
Number of read bytes	Specifies the number of bytes to be read from the Data Carrier in 4-digit hexadecimal. The maximum number of bytes that can be read at one time is 2,048 bytes. Setting range: 0001h to 0800h •ASCII: 2,048 bytes (2,048 characters) •Hexadecimal code: 2,048 bytes (4,096 characters)

### Response

Command code	End code	Read data	Terminator
r	d	0 0	x x ... x x
2		2	n
			* CR
			2

End code	Indicates the execution result for the command. The end code 00 indicates normal completion.  For details on end codes, refer to End code List.  p.82
Read data	Indicates the data read from the Data Carrier. The characters in ASCII indicate the number of read bytes and the characters in hexadecimal code indicate the number of read bytes x 2.

## EXPANSION BATCH WRITE (wt)

This command writes up to 2 Kbytes of data to the Data Carrier in a batch. If the Data Carrier is not in communications range, an error response (end code: 72 = Data Carrier non-existent) will be returned.

### Command

Command code	Data setting	Processing area number setting	Write area start address	Write data	Terminator
w	t	A/H	1	× × × ×	× × × ×
		1	× × × ×	× × × ×	* CR
2		1	4	n	2

Data setting	Specifies the code format used to send write data to the Data Carrier. A: ASCII H: Hexadecimal code
Processing area number setting	Always 1.
Write area start address	Specifies the start address of the area to be written to in 4-digit hexadecimal. Setting range: 0000h to 1FFFh
Write data	Indicates the data to be written to the Data Carrier. The maximum number of bytes that can be written at one time is 2,048 bytes. Setting range: 0001h to 0800h •ASCII: 2,048 bytes (2,048 characters) •Hexadecimal code: 2,048 bytes (4,096 characters)

### Response

Command code	End code	Terminator
w	t	0 0
		* CR
2		2

End code	Indicates the execution result for the command. The end code 00 indicates normal completion.  For details on end codes, refer to End code List.  p.82
----------	--

## EXPANSION BATCH AUTO READ (ar)

This command reads up to 2 Kbytes of data from the Data Carrier in a batch when the Hand-held Reader Writer moves close to the Data Carrier. The Hand-held Reader Writer responds when communications between the Hand-held Reader Writer and Data Carrier have ended.

### Command

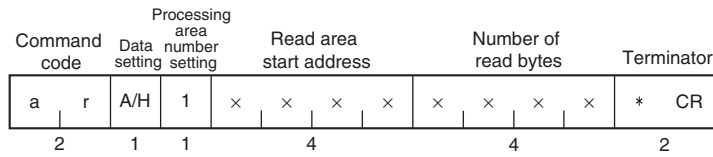

Data setting	Sets the code format used to send responses for read data. A: ASCII H: Hexadecimal code
Processing area number setting	Always 1.
Read area start address	Specifies the start address of the area in the Data Carrier to be read from in 4-digit hexadecimal code. Setting range: 0000h to 1FFFh
Number of read bytes	Specifies the number of bytes to be read from the Data Carrier in 4-digit hexadecimal. The maximum number of bytes that can be read at one time is 2,048 bytes. Setting range: 0001h to 0800h •ASCII: 2,048 bytes (2,048 characters) •Hexadecimal code: 2,048 bytes (4,096 characters)

### Response

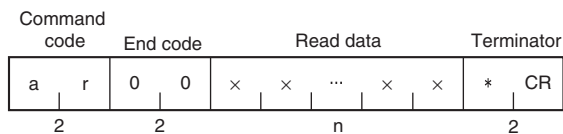

End code	Indicates the execution result for the command. The end code 00 indicates normal completion.  For details on end codes, refer to End code List.  p.82
Read data	Indicates the data read from the Data Carrier. The characters in ASCII indicate the number of read bytes and the characters in hexadecimal code indicate the number of read bytes x 2.

## EXPANSION BATCH AUTO WRITE (aw)

This command writes up to 2 Kbytes of data to the Data Carrier in a batch when the Hand-held Reader Writer moves close to the Data Carrier. The Hand-held Reader Writer responds when communications between the Hand-held Reader Writer and Data Carrier have ended.

### Command

Command code	Data setting	Processing area number setting	Write area start address	Write data	Terminator
a	w	A/H	1	× × × ×	× × × ×
2	1	1	4	n	2

Data setting	Specifies the code format used to send write data to the Data Carrier. A: ASCII H: Hexadecimal code
Processing area number setting	Always 1.
Write area start address	Specifies the start address of the area to be written to in 4-digit hexadecimal. Setting range: 0000h to 1FFFh
Write data	Indicates the data to be written to the Data Carrier. The maximum number of bytes that can be written at one time is 2,048 bytes. Setting range: 0001h to 0800h •ASCII: 2,048 bytes (2,048 characters) •Hexadecimal code: 2,048 bytes (4,096 characters)

### Response

Command code	End code	Terminator
a	w	0 0
2	2	2

End code	Indicates the execution result for the command. The end code 00 indicates normal completion.  For details on end codes, refer to End code List.  p.82
----------	--

## EXPANSION BATCH BUTTON READ (br)

After this command is received by the Hand-held Reader Writer, up to 2 Kbytes of data will be read from the Data Carrier in a batch when the activate switch is pressed. If the activate switch is pressed and the Data Carrier is not in communications range, an error response (end code: 72 = Data Carrier non-existent) will be returned.

### Command

Command code		Data setting	Processing area number setting	Read area start address				Number of read bytes				Terminator	
b	r	A/H	1	x	x	x	x	x	x	x	x	*	CR
2		1	1	4				4				2	

Data setting	Sets the code format used to send responses for read data. A: ASCII H: Hexadecimal code
Processing area number setting	Always 1.
Read area start address	Specifies the start address of the area in the Data Carrier to be read from in 4-digit hexadecimal code. Setting range: 0000h to 1FFFh
Number of read bytes	Specifies the number of bytes to be read from the Data Carrier in 4-digit hexadecimal. The maximum number of bytes that can be read at one time is 2,048 bytes. Setting range: 0001h to 0800h •ASCII: 2,048 bytes (2,048 characters) •Hexadecimal code: 2,048 bytes (4,096 characters)

### Response

Command code		End code		Read data				Terminator	
b	r	0	0	x	x	...	x	x	* CR
2		2		n				2	

End code	Indicates the execution result for the command. The end code 00 indicates normal completion.  For details on end codes, refer to End code List.  p.82
Read data	Indicates the data read from the Data Carrier. The characters in ASCII indicate the number of read bytes and the characters in hexadecimal code indicate the number of read bytes x 2.

## EXPANSION BATCH BUTTON WRITE (bw)

After this command is received by the Hand-held Reader Writer, up to 2 Kbytes of data will be written to the Data Carrier in a batch when the activate switch is pressed. If the activate switch is pressed and the Data Carrier is not in communications range, an error response (end code: 72 = Data Carrier non-existent) will be returned.

### Command

Command code		Data setting	Processing area number setting	Write area start address				Write data				Terminator	
b	w	A/H	1	x	x	x	x	x	x	x	x	*	CR
2		1	1	4				n				2	

Data setting	Specifies the code format used to send write data to the Data Carrier. A: ASCII H: Hexadecimal code
Processing area number setting	Always 1.
Write area start address	Specifies the start address of the area to be written to in 4-digit hexadecimal. Setting range: 0000h to 1FFFh
Write data	Indicates the data to be written to the Data Carrier. The maximum number of bytes that can be written at one time is 2,048 bytes. Setting range: 0001h to 0800h •ASCII: 2,048 bytes (2,048 characters) •Hexadecimal code: 2,048 bytes (4,096 characters)

### Response

Command code		End code	Terminator		
b	w	0	0	*	CR
2		2		2	

End code	Indicates the execution result for the command. The end code 00 indicates normal completion.  For details on end codes, refer to End code List.  p.82
----------	--

## EXPANSION BATCH BUTTON AUTO READ (ur)

After this command is received by the Hand-held Reader Writer, up to 2 Kbytes of data will be read from the Data Carrier in a batch when the activate switch is pressed after the Hand-held Reader Writer moves close to the Data Carrier. The Hand-held Reader Writer responds when communications between the Hand-held Reader Writer and Data Carrier have ended.

### Command

Command code	Data setting	Processing area number setting	Read area start address	Number of read bytes	Terminator
u r	A/H	1	x x x x	x x x x	* CR
2	1	1	4	4	2

Data setting	Sets the code format used to send responses for read data. A: ASCII H: Hexadecimal code
Processing area number setting	Always 1.
Read area start address	Specifies the start address of the area in the Data Carrier to be read from in 4-digit hexadecimal code. Setting range: 0000h to 1FFFh
Number of read bytes	Specifies the number of bytes to be read from the Data Carrier in 4-digit hexadecimal. The maximum number of bytes that can be read at one time is 2,048 bytes. Setting range: 0001h to 0800h •ASCII: 2,048 bytes (2,048 characters) •Hexadecimal code: 2,048 bytes (4,096 characters)

### Response

Command code	End code	Read data	Terminator
u r	0 0	x x ... x x	* CR
2	2	n	2

End code	Indicates the execution result for the command. The end code 00 indicates normal completion.  For details on end codes, refer to End code List.  p.82
Read data	Indicates the data read from the Data Carrier. The characters in ASCII indicate the number of read bytes and the characters in hexadecimal code indicate the number of read bytes x 2.



## EXPANSION BATCH BUTTON AUTO WRITE (uw)

After this command is received by the Hand-held Reader Writer, up to 2 Kbytes of data will be written to the Data Carrier in a batch when the activate switch is pressed after the Hand-held Reader Writer moves close to the Data Carrier. The Hand-held Reader Writer responds when communications between the Hand-held Reader Writer and Data Carrier have ended.

### Command

Command code		Data setting	Processing area number setting	Write area start address				Write data				Terminator	
u	w	A/H	1	x	x	x	x	x	x	x	x	*	CR
2		1	1	4				n				2	

Data setting	Specifies the code format used to send write data to the Data Carrier. A: ASCII H: Hexadecimal code
Processing area number setting	Always 1.
Write area start address	Specifies the start address of the area to be written to in 4-digit hexadecimal. Setting range: 0000h to 1FFFh
Write data	Indicates the data to be written to the Data Carrier. The maximum number of bytes that can be written at one time is 2,048 bytes. Setting range: 0001h to 0800h •ASCII: 2,048 bytes (2,048 characters) •Hexadecimal code: 2,048 bytes (4,096 characters)

### Response

Command code		End code	Terminator	
u	w	0	0	* CR
2		2	2	

End code	Indicates the execution result for the command. The end code 00 indicates normal completion.  For details on end codes, refer to End code List.  p.82
----------	--

## Calculation Write (CW)

The Data Carrier's memory data and calculation data is calculated in hexadecimal and the result is written to the Data Carrier. If an overflow during addition or underflow during subtraction occurs, the data will not be written and an error response (end code: 76 = Data check error) will be returned.

### Command

Command code		Data setting	Processing area number setting	Calculation area start address				Number of calculation area bytes		Calculation data	Terminator	
C	W	A/S	1	x	x	x	x	x	x		*	CR
2		1	1	4				2		Specified number of bytes		2

Processing specification	Specifies the calculation method. A: Add hexadecimal S: Subtract hexadecimal
Processing area number setting	Always 1.
Calculation area start address	Specifies the start address of the area to be written to in 4-digit hexadecimal. Setting range: 0000h to 1FFFh
Number of calculation area bytes	Specifies the number of bytes in the area for calculating data in 2-digit hexadecimal. Setting range: 01h to 04h
Calculation data	Specifies the numerical values to be calculated in hexadecimal.

### Response

Command code		End code		Calculation data	Terminator	
C	W	0	0		*	CR
2		2		Specified number of bytes		2

Calculation data	Returns the calculation result data written to the Data Carrier. If an overflow during addition or underflow during subtraction occurs, the end code 76 (data check error) will be returned. The data prior to the calculation will not be added to the response.
------------------	--

## FILL (FL)

This command writes one byte of specified data to the specified memory area of the Data Carrier. The write data is specified in hexadecimal.

### Command

Command code	Data setting	Processing area number setting	Write area start address	Number of write bytes	Specified data	Terminator
F   L	H	1	×   ×   ×   ×	×   ×	×   ×	*   CR
2	1	1	4	2	2	2

Data setting	Always H.
Processing area number setting	Always 1.
Write area start address	Specifies the start address of the area in the Data Carrier to be written to in 4-digit hexadecimal code. Setting range: 0000h to 1FFFh
Number of write bytes	Specifies the data to be written to the Data Carrier in 2-digit hexadecimal. Setting range: 00h to FFh (00 = 256 bytes)
Specified data	Indicates the data to be written to the Data Carrier.

### Response

Command code	End code	Terminator
F   L	0   0	*   CR
2	2	2

End code	Indicates the execution result for the command. The end code 00 indicates normal completion.  For details on end codes, refer to End code List.  p.82
----------	--

### •Example

Writing 01H to the 06H bytes in the memory area starting from address 0030H for a Data Carrier in which the same data and address is written.

### Command

Command code	Data setting	Process area number setting	Write area start address	Number of write bytes	Specified data	Terminator
F   L	H	1	0   0   3   0	0   6	0   1	*   CR
2	1	1	4	2	2	2

### Response

Command code	End code	Terminator
F   L	0   0	*   CR
2	2	2

002FH	2	F
0030H	3	0
0031H	3	1
0032H	3	2
0033H	3	3
0034H	3	4
0035H	3	5
0036H	3	6

002FH	2	F
0030H	0	1
0031H	0	1
0032H	0	1
0033H	0	1
0034H	0	1
0035H	0	1
0036H	3	6

## EXPANSION BATCH FILL (fI)

This command writes specified data for the number of write bytes starting from the specified write start address. Up to 2 Kbytes of data can be written in a batch.

### Command

Command code		Data setting	Processing area number setting	Write area start address				Number of write bytes				Specified data		Terminator	
f	I	H	1	x	x	x	x	x	x	x	x	x	x	*	CR
2		1	1	4				4				2		2	

Data setting	Always H.
Processing area number setting	Always 1.
Write area start address	Specifies the start address of the area in the Data Carrier to be written to in 4-digit hexadecimal code. Setting range: 0000h to 1FFFh
Number of write bytes	Specifies the data to be written to the Data Carrier in 4-digit hexadecimal. Setting range: 0001h to 0800h
Specified data	Indicates the data to be written to the Data Carrier.

### Response

Command code	End code	Terminator
f	I	0 0 * CR
2	2	2

End code	Indicates the execution result for the command. The end code 00 indicates normal completion.  For details on end codes, refer to End code List.  p.82
----------	--

## DATA CHECK (MDC/K)

This command writes or compares the CRC code using the specified check block unit. The CRC code is calculated from the generated polynomial expression  $X^{16} + X^{12} + X^5 + 1$ .

### Command



Command code		Process setting	Processing area number setting	Check block start address				Number of check block bytes		Terminator	
M	D	C/K	1	x	x	x	x	x	x	*	CR
2		1	1	4				2		2	

Process setting	Specifies the check process. K: Check code calculation C: Check code comparison
Processing area number setting	Always 1.
Check block start address	Specifies the start address of the check block in 4-digit hexadecimal. Setting range: 0000h to 1FFDh
Number of check block bytes	Specifies the number of bytes in the check block in 2-digit hexadecimal. Setting range: 00h, 03h to FFh (00 = 256 bytes)  The number of check block bytes is the check code calculation area + 2 bytes. For details, refer to Memory Check Function in Data Carrier.  p.93

### Response

Command code	End code	Terminator	
M	D	x	x
2	2	2	

End code	Indicates the execution result for the command. 00: Normal completion 76: Data error warning (only during comparison control)  For details on end codes, refer to End code List.  p.82
----------	--

 For details on the memory check, refer to Memory Check Function in Data Carrier.  
 p.93

CHECK!

## OVERWRITE COUNT CONTROL (MDS)

This command is used to control the number of overwrite operations performed by EEPROM Data Carriers. This command determines whether the EEPROM overwrite count has been exceeded when the specified number of overwrites is subtracted from the specified overwrite count control area data.

### Command

Command code	Mode setting	Processing area number setting	Area start address	Decrement count	Terminator
M	D	S	1	x x x x	x x * CR
2	1	1	4	2	2

Mode setting	Always S.
Processing area number setting	Always 1.
Area start address	Specifies the start address of the overwrite count control area in 4-digit hexadecimal. Setting range: 0000h to 1FFDh
Decrement count	Specifies the number of refresh operations in 2-digit hexadecimal. Setting range: 00h to FFh (00 = Performs overwrite count check only)  For details, refer to Data Carrier Service Life Detection.  p.90



CHECK!

Set the start address between □□□0H and □□□5H or between □□□8H and □□□DH. If the start address is set between □□□6H and □□□7H or between □□□EH and □□□FH, an address error (error code: 7A(HEX)) will be returned in the end code.

### Response

Command code	End code	Terminator
M	0	0
D	0	0
	*	CR
2	2	2

End code	Indicates the execution result for the command. 00: Normal completion 76: Data error warning  For details on end codes, refer to End code List.  p.82
----------	---



CHECK!

For details on controlling the overwrite count, refer to Data Carrier Service Life Detection.



p.90

# Communications Subcommands

Communications subcommands are used together with communications commands. Communications with the Data Carrier cannot be performed using only these subcommands.

## COMMAND PROCESSING TERMINATE (AA)

Terminates the processing of the communications commands and error noise detection commands, and restores the command wait status.

**Command**

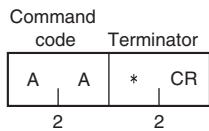

**Response**

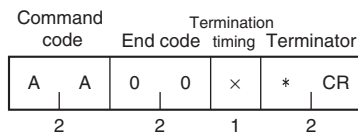

End code	<p>Indicates the execution result for the command.</p> <p>00: Normal completion 15: Command processing not executed.</p> <p>For details on end codes, refer to End code List.  p.82</p>
Termination timing	<p>Indicates the timing for terminating command processing.</p> <p>0: Terminated before Data Carrier detection. 1: Terminated during Data Carrier detection.</p>

# Host Commands

## TEST (TS)

This command returns test messages sent from the host device without changing anything. The TEST command is used for communications tests between the host device and the Hand-held Reader Writer.

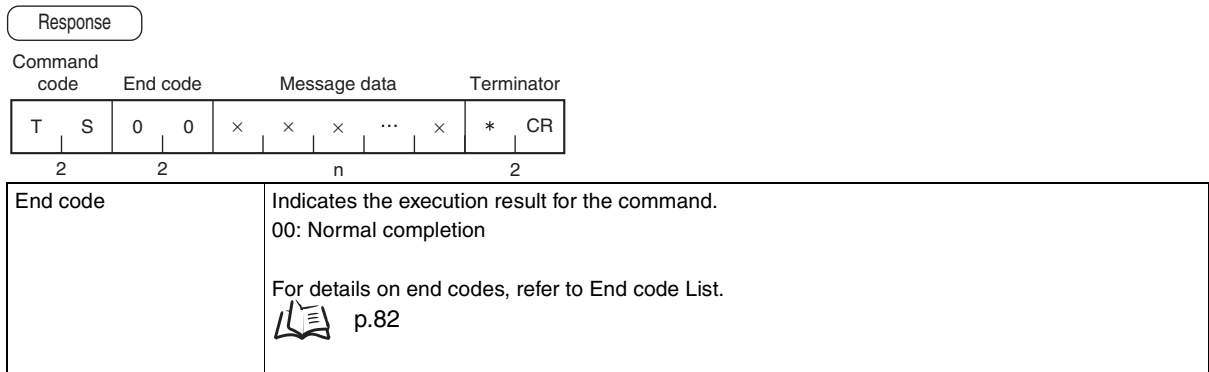
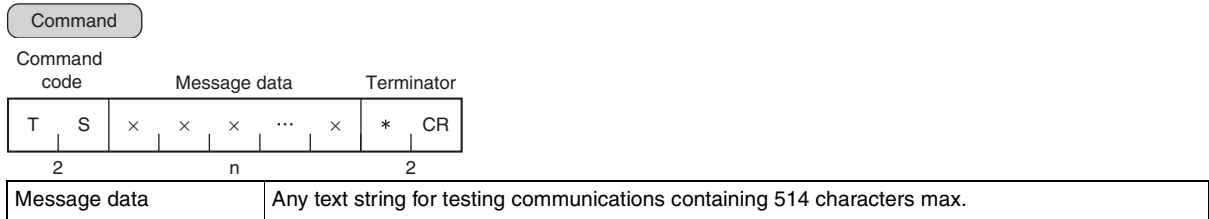

## VERSION READ (VS)

Reads the Hand-held Reader Writer's model information, software version, and software creation date.

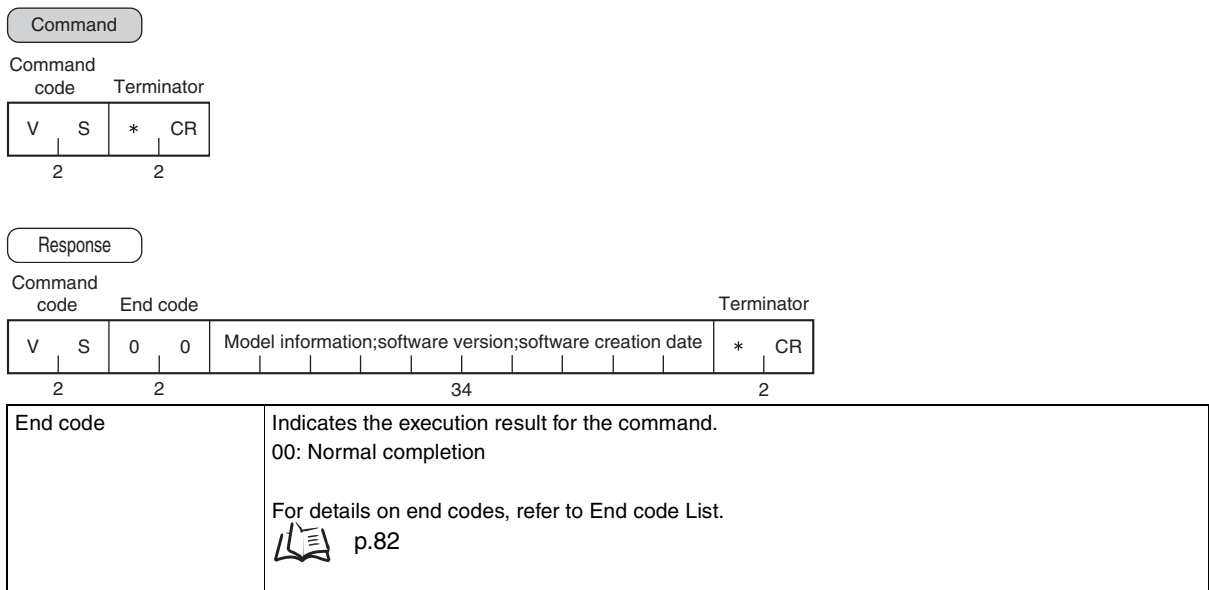



# Evaluation Commands

Frequently occurring errors during communications with the Data Carrier may be due to ambient noise. The evaluation commands are used to determine whether noise is a factor causing the error. These commands can also be used to determine the noise level at the installation site before installing the V600-series Data Carrier, Antenna, and Controller.

The reception waveform may still be unstable even if the read results are normal. By using the evaluation commands, details on the reception status can be detected, including the accuracy of the reception waveform.

## NOISE DETECTION (NS)

This command detects the noise level when a command is received.

### Command

Command code	Detection mode	Terminator
N S	H/R	* CR
2 2	1	2

Detection mode	Specifies the method used to determine the noise level. H: The Hand-held Reader Writer responds to numerical data and the host device determines the noise level. R: The noise level is determined by the Hand-held Reader Writer, and the response is sent as the detection result.
----------------	--

### Response

Detection mode setting: H

Command code	End code	Detection result				Terminator
N S	0 0	Absolute value average	Input value average	Minimum input value	Maximum input value	* CR
2 2	2 2	2	2	2	2	2

Absolute value average	Indicates the average value for the detected noise level absolute value in 2-digit hexadecimal.
Input value average	Indicates the average value for the detected noise level input value in 2-digit hexadecimal.
Minimum input value	Indicates the minimum value for the detected noise level input value in 2-digit hexadecimal.
Maximum input value	Indicates the maximum value for the detected noise level input value in 2-digit hexadecimal.

Detection mode setting: R

Command code	End code	Detection result	Terminator
N S	0 0	A/B	* CR
2 2	2 2	1	2

End code	Indicates the execution result for the command. The end code 00 indicates normal completion.  For details on end codes, refer to End code List.  p.82
Detection results	Indicates the noise level result determined by the maximum absolute value of the detected data. A: Minimum noise (indicator lit green) B: Maximum noise (indicator flashing red quickly)

## ABNORMAL NOISE DETECT (EN)

This command detects noise above a certain level. After the command is received, communications are monitored to check whether noise above a specified level occurs within a specified detection time. Use this command to determine the noise interference level when determining the installation location of the Data Carrier and Antenna.

### Command

Command code	Noise level	Detection time	Terminator
E N	× ×	× × × ×	* CR
2	0 or 2	0 or 4	2

Noise level	Specifies the abnormal noise level in 2-digit decimal. (This setting can be omitted. See note.) Setting range: 00 to 50 (×0.1 V) Default setting: 2.5 V
Detection time	Specifies the abnormal noise detection time in 4-digit decimal. (This setting can be omitted. See note.) Setting range: 0000 to 9999s Default setting: 0060s When 0000 is set, an immediate response (0 s) is sent.

Note: If these settings are omitted, detection will be performed using the data specified the previous time that noise level and detection time was specified for this command. If the command is being sent for the first time, the command will be sent with the default settings.

### Response

Header	End code	Result	Maximum noise level	Terminator
E N	0 0	×	× × ×	* CR
2	2	1	2	2

End code	Indicates the execution result for the command. The end code 00 indicates normal completion.  For details on end codes, refer to End code List.  p.82
Result	Indicates the noise level detection result. 0: Within normal range (indicator lit green) 1: Within abnormal range (indicator flashing red quickly)
Maximum noise level	Indicates the maximum noise level (V) detected within the detection time specified by the command in 2-digit decimal. The unit is 0.1 V



When the detected noise level is lower than the noise level specified by the command, detection will be continued for the specified time. If the noise level specified by the command is exceeded, a response is returned immediately, regardless of the specified detection time.

## Other Commands

### UNDEFINED COMMAND RESPONSE (IC)

This command is returned as the response when the Hand-held Reader Writer cannot read the command header.

Response		
Command code	End code	Terminator
I C	× ×	* CR
2	2	2

### Error Response

If an error occurs during communications with the host device, or the Data Carrier, error notification is provided in the end code.

Response		
Command code	End code	Terminator
× ×	× ×	* CR
2	2	2

## End code List

End codes are indicated in 2-digit hexadecimal code.

Status	End code	Meaning
Normal	00	Normal completion
	7B	Battery low warning indicating that battery replacement is required (See note.)
Host communications error	14	Format error
	15	Execution status error
	18	Frame length error
Lower communications error	70	Data Carrier communications error
	71	Mismatch error
	72	Data Carrier non-existent error
	76	Data error
	7A	Address error
	7C	Antenna error
	7D	Write protect error

Note) A 7B error code response indicates that the command was completed normally, but the battery voltage is low. If the battery voltage is so low that a response cannot be returned, an error code such as 72 will be returned.



For details on each error, refer to Error Tables.

CHECK!



p.96

## Section 4 Functions

☒ Hand-held Reader Writer	84
Multiple Area Control	84
☒ Data Carrier	85
Manufacturing Date Format (Default Setting)	85
Write Protect Function	86
Data Carrier Service Life Detection	90
Memory Check Function in Data Carrier	93

# Hand-held Reader Writer Functions

## Multiple Area Control

The Hand-held Reader Writer can read and write across several non-consecutive Data Carrier memory areas (10 areas max.) at one time. To use this feature, the number of control areas is specified using the NUMBER OF CONTROL AREAS command. ASCII and hexadecimal code can be used simultaneously for the one command control, but reading and writing cannot be performed simultaneously.

Example: Data in the Following 3 Areas are Read

Area (1) : Address                    0010H  
           : Number of bytes        05 bytes  
           : Code setting            ASCII

Area (2) : Address                    0030H  
           : Number of bytes        02 bytes  
           : Code setting            Hexadecimal



Area (3) : Address                    0035H  
           : Number of bytes        03 bytes  
           : Code setting            Hexadecimal

Area (1)	0010H	4	F	"O"
	0011H	4	D	"M"
	0012H	5	2	"R"
	0013H	4	F	"O"
	0014H	4	E	"N"
Area (2)	0030H	1	2	
	0031H	3	4	
Area (3)	0035H	3	1	
	0036H	3	2	
	0037H	3	3	

Command RDA3001005H003002H003503\*CR  
 Response RD00OMRON1234313233\*CR

└───┬───┬───┘  
Area (1) Area (2) Area (3)

 Refer to Command and Response Format for more details on ASCII and hexadecimal codes.

  p.34

# Data Carrier

The memory access space available to the Hand-held Reader Writer is 0000H to 1FFFH, totaling 8 Kbytes. The available access space is determined by the Data Carrier memory capacity. The allocations for the Hand-held Reader Writer's manufacturing date area, write-protect area, and control methods for these areas depend on the type of Data Carrier memory used (SRAM or EEPROM).



For details on the Data Carrier, refer to the Appendices or the *Read/Write Head and Data Carrier Manuals* (Cat. No. Z127-E1, Z128-E1).

 p.99

## Manufacturing Date Format (Default Setting)

### •Using SRAM (Built-in Battery) Data Carrier

The date of manufacture is registered in the first 2 bytes of the memory area, which control the Data Carrier battery life. This area can be read, but cannot be written to by the user. If a writing operation mistakenly occurs, an error (error code: 7D) will result.

Manufacturing Date Area

Address \ Bit	7	6	5	4	3	2	1	0
0000	Second digit of month				First digit of month			
0001	Second digit of year				First digit of year			

Note 1. The year of manufacture is represented by the last two digits of the year (for example, "92" for 1992).

2. The month of manufacture is represented by two digits (for example, "03" for March and "10" for October).

3. Years from 2000 onwards are represented beginning with 00 (for example, "0400" for April 2000 and "1204" for December 2004).

Example: Manufacturing Date of September 1992

Address \ Bit	7	6	5	4	3	2	1	0
0000	0	0	0	0	1	0	0	1
	0				9			
0001	1	0	0	1	0	0	1	0
	9				2			

### •Using EEPROM (Without Battery) Data Carrier

There is no manufacturing date area. The start address is a write-protected area.

## Write Protect Function

The write protect function prevents important data stored in the Data Carrier, such as the product type and model, from being overwritten by other data and lost. Use the following methods to set write protection after writing important data.

### •EEPROM Data Carriers (without Battery)

#### Setting the Write Protect Function

The write protect function is set by writing the final address to be protected in address 0000H of the Data Carrier's memory. The area between address 0001H and the write-protect end address will be write-protected. The status of the most significant bit of address 0000H determines whether or not the write protect function is in effect.

Address	Bit	7	6	5	4	3	2	1	0
0000	Yes/ No								

#### •Write-protect Bit (Most significant bit of address 0000H)

- 1: Write-protected (Yes)
- 0: Not write-protected (No)

#### •End address setting range

00H, 01H to 7FH

Address 0080H to 00FFH can therefore not be set as the end address. If the end address is set to 00H, however, all addresses from 0001H to 00FFH will be protected.

### Write-protect Setting Examples (254-byte Memory Data Carrier)

#### (1) The following settings would write-protect addresses 0001H through 0012H:

Address	Bit	7	6	5	4	3	2	1	0
0000		1	0	0	1	0	0	1	0
		9				2			

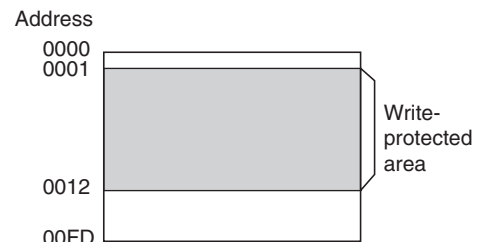

#### (2) The entire memory except address 0000H is write-protected by setting the end address to 00H, as shown below.

(Example: When the end address is 00H)

Address	Bit	7	6	5	4	3	2	1	0
0000		1	0	0	0	0	0	0	0
		8				0			



### Canceling Write Protection

To cancel write protection, turn OFF the most significant bit of address 0000H. The write protection will be cancelled, and the address set in 0000H will be ignored.



CHECK!

Address 0000H is the write protection setting area. Therefore, always structure the data so that any data that needs to be write protected is written in addresses starting from 0001H.



•SRAM Data Carriers (with Built-in Battery)

Setting Write Protect Function

The write protect function is set in the four bytes of addresses 0002H through 0005H of the Data Carrier's memory. The status of the most significant bit of address 0002H determines whether or not the write protect function is enabled.

Address \ Bit	7	6	5	4	3	2	1	0
0002	Yes/ No	Upper two digits of start address						
0003	Lower two digits of start address							
0004	Upper two digits of end address							
0005	Lower two digits of end address							

•Write-protect Bit (most significant bit of address 0002H)

- 1: Data is write-protected
- 0: Data is not write-protected

•Write Protect Setting Area

- Start address: 0006H to 1FFFH
- End address: 0006H to 1FFFH

Settings to write-protect addresses 0006H through 07FFH

Address \ Bit	Upper digit				Lower digit			
0002	1	0	0	0	0	0	0	0
	8				0			
0003	0	0	0	0	0	1	1	0
	0				6			
0004	0	0	0	0	0	1	1	1
	0				7			
0005	1	1	1	1	1	1	1	1
	F				F			

Settings to not write-protect addresses

Address \ Bit	Upper digit				Lower digit			
0002	0	0	0	0	0	0	0	0
	0				0			
0003	0	0	0	0	0	1	1	0
	0				6			
0004	0	0	0	0	0	1	1	1
	0				7			
0005	1	1	1	1	1	1	1	1
	F				F			

 **WARNING**

The SRAM Data Carrier has a built-in lithium battery that can ignite, combust, or explode if mishandled, which may occasionally result in serious injury. Do not disassemble, pressurize, or deform the Data Carrier, subject it to high temperatures (of 100°C or more), or dispose of it by incineration. Dispose of the Data Carrier as industrial waste.



## Write Protect Setting Examples (2-Kbyte Memory Data Carrier)

### (1) Settings to Write-protect Addresses 0015H to 0120H (Start address < End address)

Address \ Bit	7	6	5	4	3	2	1	0
0002	1	0	0	0	0	0	0	0
	8				0			
0003	0	0	0	1	0	1	0	1
	1				5			
0004	0	0	0	0	0	0	0	1
	0				1			
0005	0	0	1	0	0	0	0	0
	2				0			

(Hexadecimal)

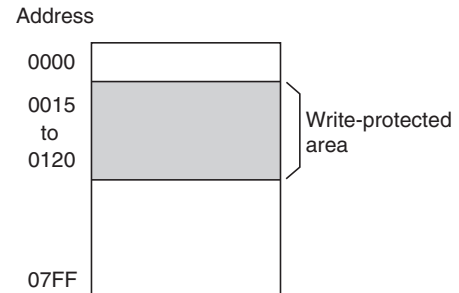

### (2) Settings to Write-protect 1 Byte (Start address = End address)

Specify the same address for the start and end addresses.

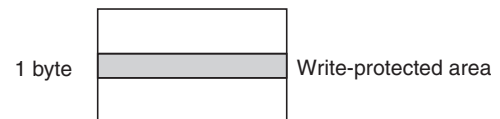

### (3) Settings when the End Address is Greater than the Final Address in the Data Carrier (End address > 07FFH)

The Data Carrier memory area is allocated from address 0000H to 07FFH. Therefore, the addresses up to 07FFH will be write-protected.

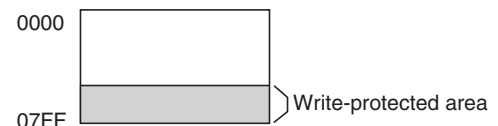

### (4) Settings when the Start Address is Greater than the End Address

(Start address > End address)

The area between 0006H and the end address and the area between the start address and 07FFH are write-protected.

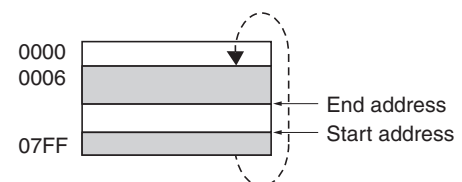

## Canceling Write Protection

To cancel write protection, turn OFF the most significant bit of address 0002H. The write protection will be cancelled, and the start and end addresses that are set for 0002H to 0005H will be ignored.

## Data Carrier Service Life Detection

The methods used to detect the service life of the Data Carrier depend on the memory type (SRAM or EEPROM). For SRAM, a battery life check is performed, and for EEPROM, the number of overwrites is monitored.

### •SRAM Data Carriers (with Built-in Battery)

#### Checking If the Battery is Low

Built-in Battery (Not Including V600-D2KR16)

(1)A battery-low check for the Data Carrier can only be performed when special access is made. The battery-low check is performed by running a fixed current through the internal circuit of the Data Carrier. If the battery-low check is performed every time access is made, battery power is also consumed. It is recommended that this be included as a routine check, once a day, when creating system programs.

(2)The access method for performing a battery-low check can only be performed when the two bytes of data from addresses 0000H to 0001H are read. Execute one of the following commands to perform a battery-low check.

:

Battery-low Check Commands

a. READ command	RD H/A1 0000 02*CR
b. AUTO READ command	AR H/A1 0000 02*CR
c. BUTTON READ command	BR H/A1 0000 02*CR
d. BUTTON AUTO READ command	UR H/A1 0000 02*CR
e. COPY READ command	RC H/A1 0000 0002*CR
f. EXPANSION DIVIDED READ command	XR H/A1 0000 0002*CR
g. EXPANSION DIVIDED AUTO READ command	NR H/A1 0000 0002*CR
h. EXPANSION BATCH READ command	rd H/A1 0000 0002*CR
i. EXPANSION BATCH AUTO READ command	ar H/A1 0000 0002*CR
j. EXPANSION BATCH BUTTON READ command	br H/A1 0000 0002*CR
k. EXPANSION BATCH BUTTON AUTO READ command	ur H/A1 0000 0002*CR

#### (3)Response for Low Battery

When the battery is low, 7B is given in the end code section within the response format.

Example

Normal

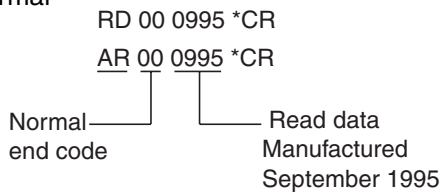

Battery Low

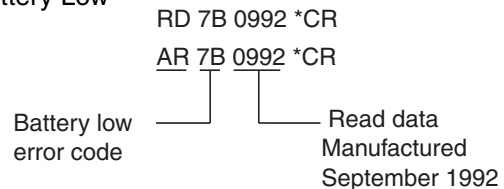

- A battery low check is performed for V600-D2KR16 Data Carriers with replaceable batteries when the READ/WRITE commands are executed, regardless of the addresses.

## Data Carrier Life after Low Battery Signal Occurs

After a battery-low signal is sent, the Data Carrier can be used for approximately one month in the normal operating state. The Data Carrier should be replaced, however, as soon as possible.



The SRAM Data Carrier (except the V600-D2KR16) is equipped with a thionyl chloride lithium battery. A characteristic of the thionyl chloride lithium battery is that the internal resistance of the battery increases when the battery is left unused for several months. If this occurs and a Data Carrier battery-low check is performed, a low battery response may be returned regardless of whether battery life still remains. This is a result of the increased resistance within the battery, and is not due to the battery life expiring. If a Data Carrier has been left for several months after purchase without being used, use the read operation for approx. 10 minutes to activate the battery before use. (Current will flow in the battery and resistance in the battery will return to normal as a result of activating the battery. The life of the battery will hardly be affected.)

When using V600-D2KR16 Data Carriers with replaceable batteries, the Data Carrier can be used for approximately two weeks in the normal operating state. The battery should be replaced, however, as soon as possible.

### •EEPROM Data Carrier (without Battery)

The OVERWRITE COUNT CONTROL command (MDS) can determine whether the overwrite count for the EEPROM Data Carrier has been exceeded. By executing the OVERWRITE COUNT CONTROL command, the number of overwrites is decremented from the data in the specified overwrite count control area, and whether the data has exceeded the limits is determined.

The overwrite count control area consists of 3 bytes from the start address. The decrement value from the overwrite count is written in this area, and if this value is 0 (00H) an end code 76 will be given as a warning. Therefore, to enable control of the number of overwrites, the maximum number of overwrites must be written to the overwrite count control area beforehand.

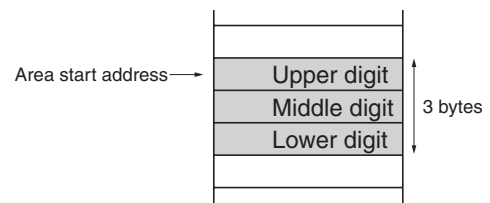

The user-specified number of overwrites can be set to up to 16,700,000. The number of overwrites in the specifications for EEPROM Data Carriers, however, is 300,000 overwrites (0493E0H) at 40°C max., so be sure to set the number of overwrites to 300,000 or lower.

The number of overwrites is controlled using hexadecimal values, and can be read using the READ command.

If the control area data is already 0, the control area value will not be refreshed, and only a warning will be returned as a response. When the refresh count is set as 00H, the count will not be updated, and only an overwrite count check will be performed.



Set the start address to between  $\square\square\square0H$  and  $\square\square\square5H$  or between  $\square\square\square8H$  and  $\square\square\squareDH$ . If the start address is set between  $\square\square\square6H$  and  $\square\square\square7H$  or between  $\square\square\squareEH$  and  $\square\square\squareFH$ , an address error (error code: 7A hexadecimal) will be returned as the end code.



For details on command format, refer to REF OVERWRITE COUNT CONTROL (MDS).



### Using the OVERWRITE COUNT Command

Example: When the three bytes from address 0010H are used as the overwrite count area.

1. The overwrite count initial value of 100,000 times is written in the control area.  
"WTH10010"
2. Enter the overwrite count of 5.  
"MDS1001005"  
A total of 5 times will be decremented from 100,000.

0010	01H
0011	86H
0012	A0H

0010	01H
0011	86H
0012	9BH

3. The accumulated count is 100,000 times.  
When "MDS1001000" is executed, it will be "MD76" (overwrite count exceeded.)

0010	00H
0011	00H
0012	00H

## Memory Check Function in Data Carrier

A memory check can be made using the DATA CHECK command (MDC/K). A CRC (Cyclic Redundancy Check) code calculation, overwrite, and comparison are made, using the check block units specified by the user. The CRC code is calculated from the generated polynomial expression  $x^{16} + x^{12} + x^5 + 1$ .

The calculation area is the portion of the check block specified by the start address and the number of bytes excluding the last two bytes. The last two bytes are the check code area. When check code write is specified (transaction code: K), the CRC of the calculation area data is calculated and written to the check code area. When data comparison is specified (transaction code: C), the CRC of the calculation area data is calculated and a comparison made with the check code area data. If they coincide, end code 00 is returned, indicating normal transmission, and if they do not coincide, end code 76 is returned as a warning.

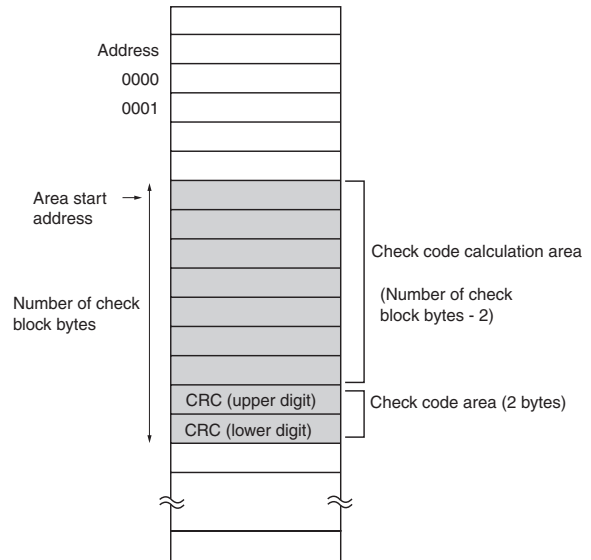

For details on the command format, refer to DATA CHECK (MDC/K).

 p.75

### Example Using the Data Carrier's DATA CHECK Command

In the following example, the data in address 0010H to 0012H is checked.

1. In this example, the following data already exists in the memory.
2. Execute MDK1001005 (calculation transaction).

The CRC code 5CD6 calculated from the data 123456 is written to addresses 0013H and 0014H.

0010	12H
0011	34H
0012	56H
0013	
0014	

0010	12H
0011	34H
0012	56H
0013	5CH
0014	D6H

3. Execute MDC1001005 (comparison transaction). The normal response MD00 will be returned if the data coincides.

0010	12H
0011	34H
0012	56H
0013	5CH
0014	D6H

If the data error occurs, MD76 (a data error warning) will be returned.

0010	00H	← Data error
0011	34H	
0012	56H	
0013	5CH	
0014	D6H	



# Section 5

## Troubleshooting

❏ Error Tables	96
Fatal Errors (Operation Stops)	96
Non-fatal Errors (Operation Continues)	96
❏ Troubleshooting Flowchart	97

## Error Tables

If an error occurs in the Hand-held Reader Writer, the operation indicator lights or flashes red to notify the type of error.

### Fatal Errors (Operation Stops)

If a fatal error occurs, the operation indicator will be lit red and all operations of the Hand-held Reader Writer will stop until the power is turned OFF and then ON again.

Name	Description
Hardware error	Hand-held Reader Writer cannot be operated normally.

### Non-fatal Errors (Operation Continues)

If a non-fatal error occurs, the operation indicator will be lit red (for a Data Carrier non-existent error, the indicator will flash red) and an error code will be returned to the host device.

Name	Description
Format error	The command from the host device was incorrectly formatted.
Frame length error	Command exceeding the maximum frame length was received.
Data Carrier communications error	Communications with the Data Carrier could not be performed correctly.
Mismatch error	Write control was not performed correctly.
Data Carrier non-existent error	A command that was not an auto command was sent when the Data Carrier was not in the communications area. A command OFF occurred with the auto command.
Address error	An address that exceeded the Data Carrier memory area was designated.
Write protect error	The manufacturing date area or the write protect area was designated with a WRITE command.

# Troubleshooting Flowchart

If an error occurs, be sure to understand the conditions thoroughly, then accurately determine the likelihood of the error re-occurring, whether the problem is related to another device, and other factors causing the error, and refer to the following flowcharts for troubleshooting.

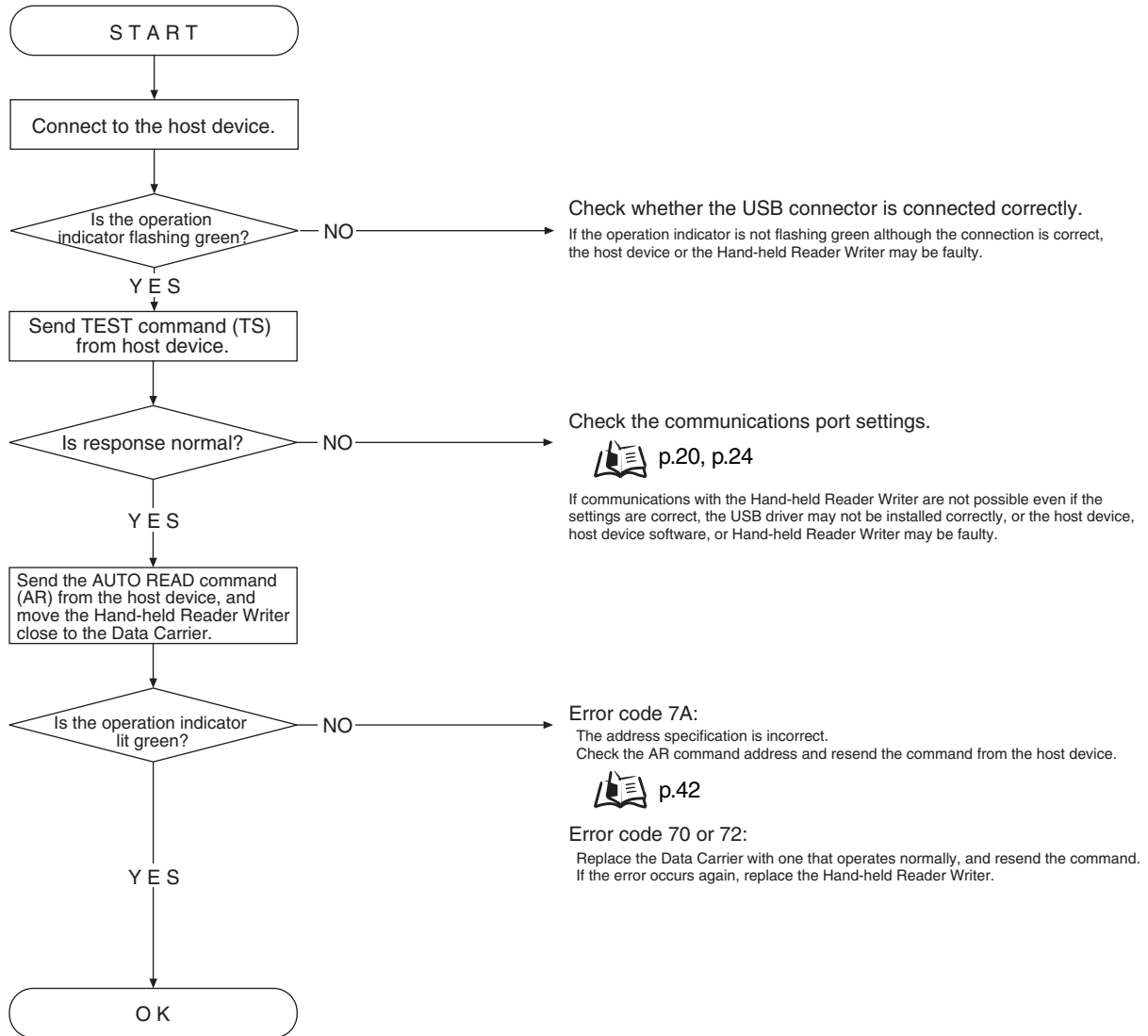

MEMO

# Section 6

## Appendices

☒ Specifications and Dimensions	100
☒ Data Carrier Memory Map	106
☒ Data Carrier Memory Capacity and Data Type (V600 Series)	107
☒ List of ASCII Characters	108
☒ Degree of Protection	109

# Specifications and Dimensions

## General Specifications

Item	Specification
Supply voltage	5.0 VDC $\pm$ 5%
Ambient operating temperature	-10 to 55°C
Ambient operating humidity	35% to 85% (with no condensation)
Ambient storage temperature	-25 to 65°C
Ambient storage humidity	35% to 85% (with no condensation)
Degree of protection	IEC60529, IP63 (See note.)
Weight	Approx. 120 g (with cables and connectors)
Current consumption	250 mA max. (supply voltage: 5.0 V)
Material	Case: ABS resin; Nameplate: PET resin
Vibration resistance	10 to 150 Hz, 0.2-mm double amplitude at 15 m/s <sup>2</sup> acceleration in 6 directions 10 times for 8 minutes each
Shock resistance	150 m/s <sup>2</sup> (approx. 15G), 3 times each in 6 directions (up, down, right, left, forward, reverse)
Insulation resistance	50 M $\Omega$ min. (at 500 VDC) between connector terminals and case
Dielectric strength	1,000 VAC, 50/60 Hz for 1 min between connector terminals and case (leakage current: 1 mA max.)
Cable length	0.8 m, 1.9 m

Note: This does not include the connector section. The main unit is not resistant to chemicals or oils.

## Performance Specifications

Item	Specification
Diagnostic function	Checks for CPU errors.

## Communications Specifications

### •Host Communications Interface Specifications

Item	Specification
Connectors (connector connection status)	Series A plug
USB specifications	Ver 1.1
Baud rate	Full speed (12 Mbps)
Device class	COM class
Vendor ID	Hexadecimal format [0590]
Product ID	Hexadecimal format [0048]



Use the host communications interface as the COM port for the host device.

CHECK!

## Dimensions

V600-CHUD

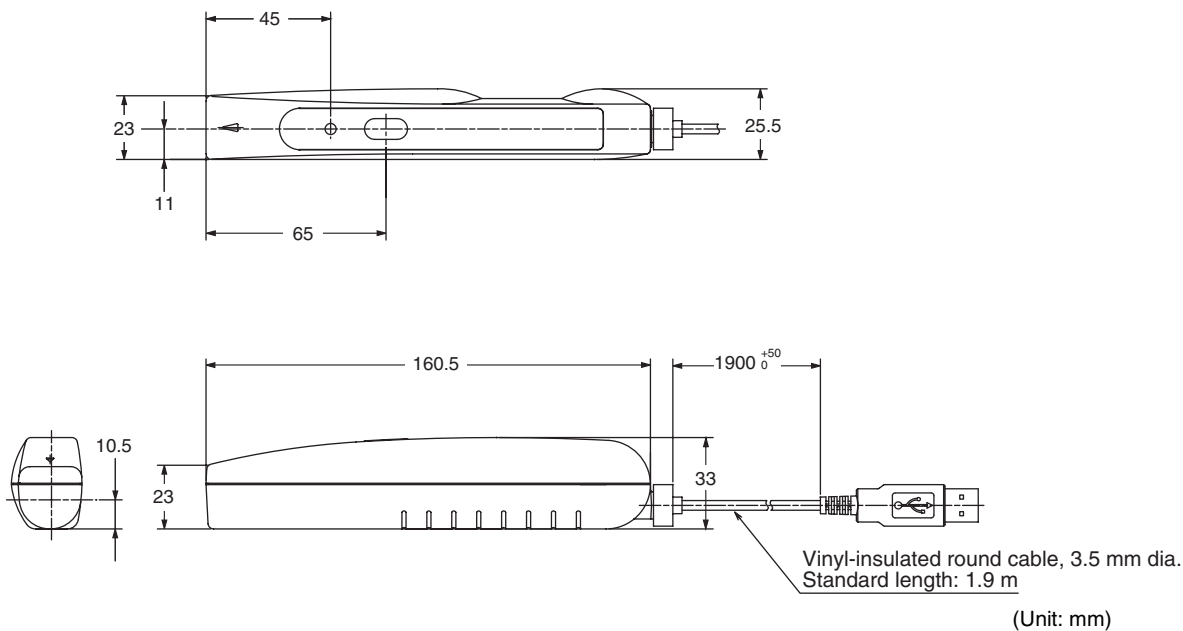

## Transmission Specifications

Transmission with the currently available V600-series Data Carriers is possible.

### •Transmission Distances

Data Carrier	Transmission distance
V600-D23P53	0 to 2.5 mm
V600-D23P54	0 to 4 mm
V600-D23P55	0 to 10 mm
V600-D23P61	0 to 11 mm
V600-D23P66N	0 to 17 mm (See note 2.)
V600-D23P66SP	0 to 12 mm
V600-D23P71	0 to 25 mm
V600-D23P72	0 to 23 mm
V600-D8KR04	0 to 35 mm
V600-D8KR12	0 to 25 mm
V600-D8KR13	0 to 20 mm
V600-D2KR16	0 to 10 mm

#### Note 1: Data Carrier Installation Conditions

V600-D23P53/P54	Embedded in metal (iron).
V600-D23P55	Embedded in resin
V600-D23P61	Metal (iron) on the back surface of the Data Carrier.
V600-D23P66N/P66SP/P71/P72	Resin on the back surface of the Data Carrier. Data Carrier (no metal on back surface))
V600-D8KR04/R12/R13	Metal (iron) on the back surface of the Data Carrier.
V600-D2KR16	Data Carrier installed on a bracket and attached to a metal (aluminium) plate.

Note 2: When using the V600-D23P66N at temperatures of  $-10^{\circ}\text{C}$  or lower, transmission may not be possible at the specified distance. In this case, move the Reader Writer slightly further away from the Data Carrier.



•Transmission Range (Reference)

V600-D23P53

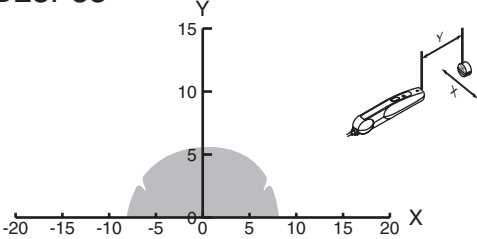

V600-D23P54

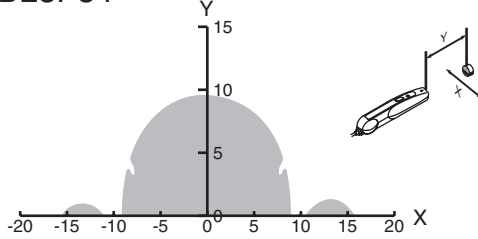

V600-D23P55

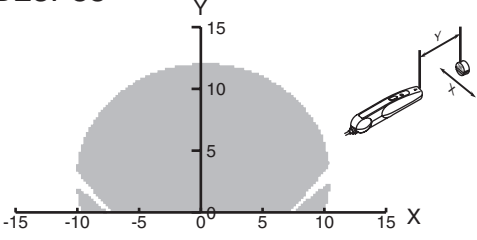

V600-D23P61

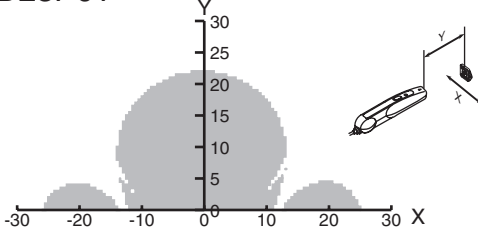

V600-D23P66N

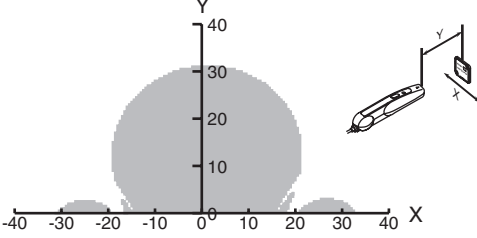

V600-D23P66SP

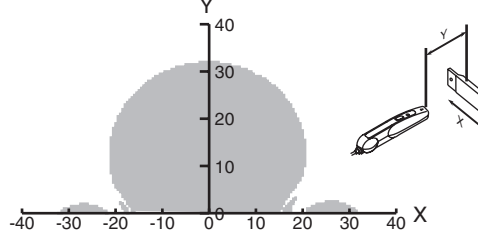

V600-D23P71

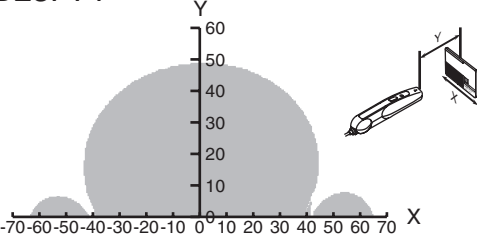

V600-D23P72

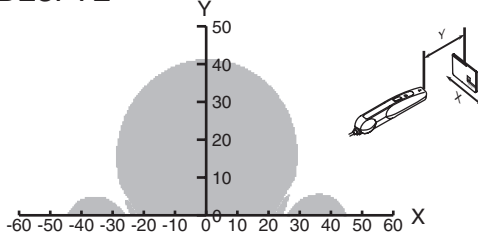

V600-D2KR16

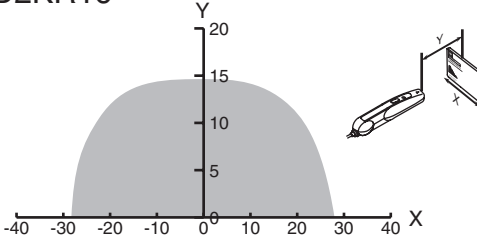

V600-D8KR04

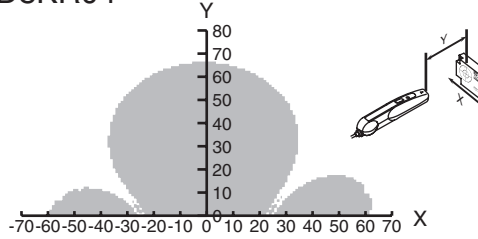

V600-D8KR12

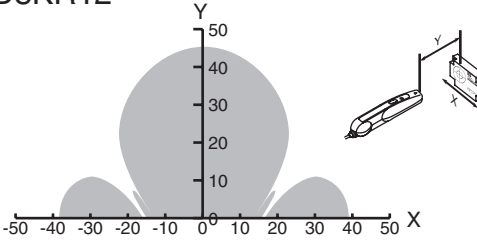

V600-D8KR13

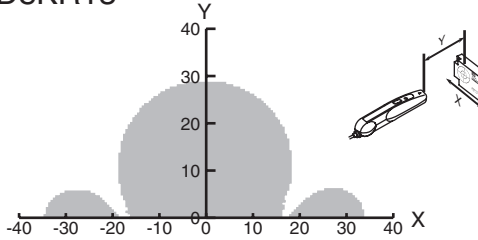

(Unit: mm)

## Communications Time

Communications time differs according to the type of Data Carrier memory (SRAM or EEPROM). TAT (Turn Around Time) and transmission time are displayed as communication times. TAT represents the total time from when a command is first sent from the host device until a response is received. The transmission time represents the time required for communications between the Hand-held Reader Writer and the Data Carrier, not including communications with the host device.

Example

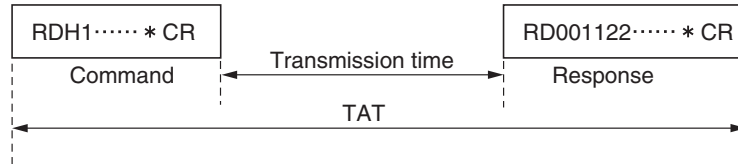

- SRAM Data Carrier (Reference)
- TAT

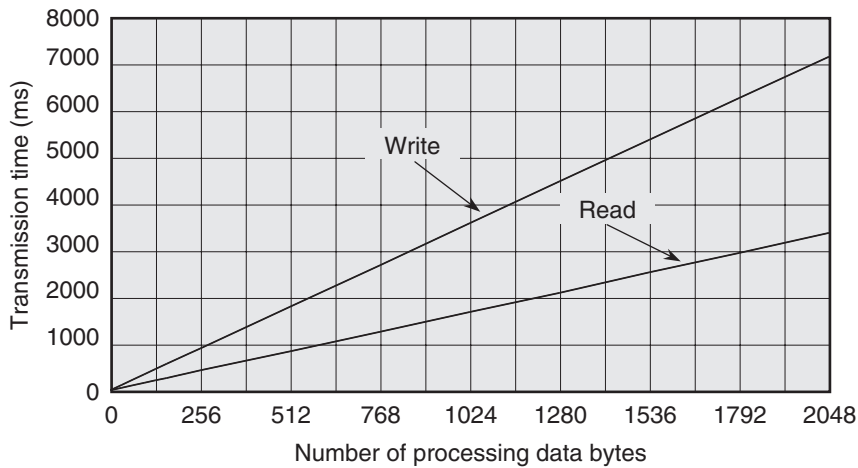

- Transmission Time

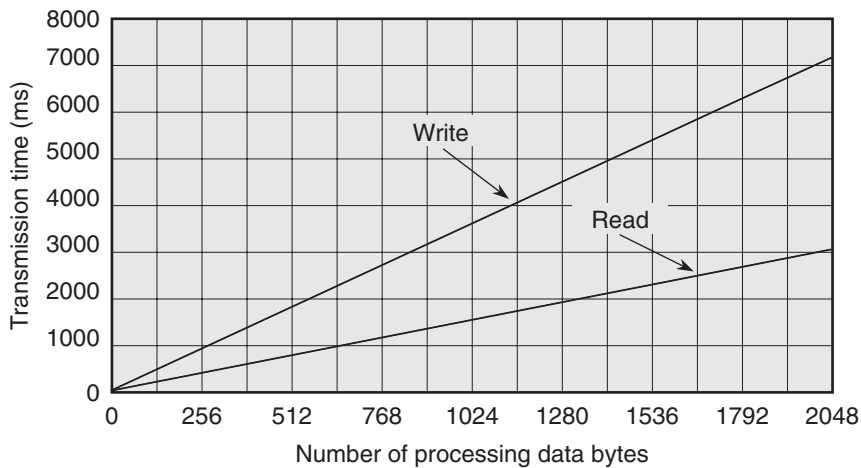

### Calculation Method

Operation	Transmission time (ms)
Read	$T=1.5N+36.7$
Write	$T=3.5N+51.2$

N: Number of processing data

- EEPROM Data Carrier (Reference)
- TAT

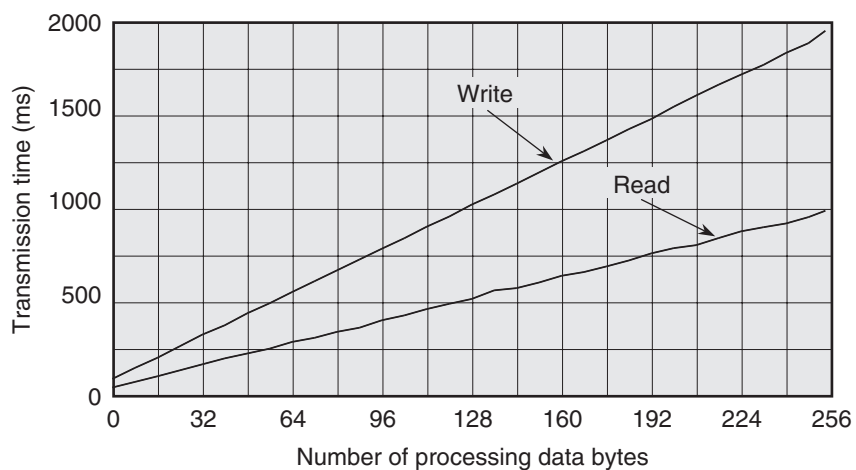

- Transmission Time

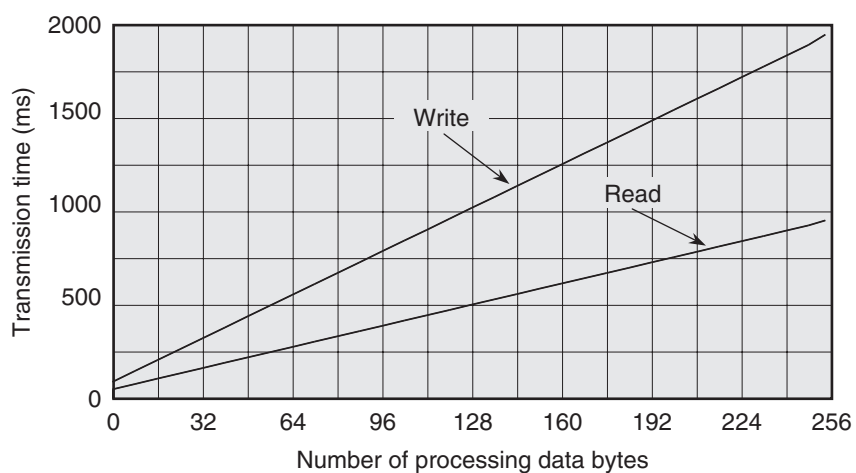

Calculation Method

Operation	Transmission time (ms)
Read	$T=3.6N+53.7$
Write	$T=7.3N+90.3$

N: Number of processing

# Data Carrier Memory Map

•Data Carrier (Memory ≤ 256 Bytes)

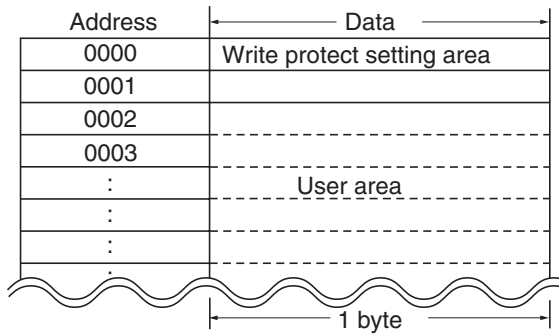

•Data Carrier (Memory > 256 Bytes)

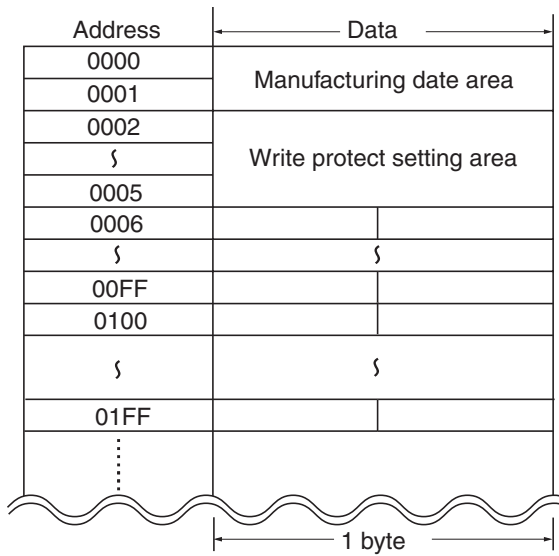

For more information on Data Carrier memory capacity and memory type, refer to Data Carrier Memory Capacity and Data Type (V600 Series).

# Data Carrier Memory Capacity and Data Type (V600 Series)

(As of September 1999)

Model	Memory capacity (user memory)	Memory type	Life expectancy
V600-D8KR12	2 Kbytes	S-RAM	5 years (-25 to +70°C)
V600-D8KR13			8 years (-25 to +70°C)
V600-D8KR04			
V600-D2KR16	2 Kbytes	SRAM (replaceable battery)	2 years (+25°C)
V600-D23P53	254 bytes	EEPROM	<ul style="list-style-type: none"> <li>•Overwrite operations: 100,000 times (300,000 times at operating temperature between lower limit and 40 °C)</li> <li>•Data retention: 10 years</li> </ul>
V600-D23P54			
V600-D23P55			
V600-D23P61			
V600-D23P71			
V600-D23P72			
V600-D23P66N			
V600-D23P66SP			

## WARNING

The SRAM Data Carrier has a built-in lithium battery that can ignite, combust, or explode if mishandled, which may occasionally result in serious injury. Do not disassemble, pressurize, or deform the Data Carrier, subject it to high temperatures (of 100°C or more), or dispose of it by incineration. Dispose of the Data Carrier as industrial waste.



# List of ASCII Characters

Left digit Right digit	b8 to b5	0000	1001	0010	0011	0100	0101	0110	0111	1000	1101	1010	1011	1100	1101	1110	1111
	b4 to b1 Col- umn Row	0	1	2	3	4	5	6	7	8	9	10	11	12	13	14	15
0000	0	NUL	TC <sub>7</sub> (DLE)	(SP)	0	@	P	`	p	Undefined	Undefined	Undefined	Undefined	Undefined	Undefined	Undefined	Undefined
0001	1	TC <sub>1</sub> (SOH)	DC <sub>1</sub>	!	1	A	Q	a	q								
0010	2	TC <sub>2</sub> (STX)	DC <sub>2</sub>	"	2	B	R	b	r								
0011	3	TC <sub>3</sub> (ETX)	DC <sub>3</sub>	#	3	C	S	c	s								
0100	4	TC <sub>4</sub> (EOT)	DC <sub>4</sub>	\$	4	D	T	d	t								
0101	5	TC <sub>5</sub> (NEQ)	TC <sub>8</sub> (NAK)	%	5	E	U	e	u								
0110	6	TC <sub>6</sub> (ACK)	TC <sub>9</sub> (SYN)	&	6	F	V	f	v								
0111	7	BEL	TC <sub>10</sub> (ETB)	'	7	G	W	g	w								
1000	8	FE <sub>0</sub> (BS)	CAN	(	8	H	X	h	x								
1001	9	FE <sub>1</sub> (HT)	EM	)	9	I	Y	i	y								
1010	10	FE <sub>2</sub> (LF)	SUB	*	:	J	Z	j	z								
1011	11	FE <sub>3</sub> (VT)	ESC	+	;	K	[	k	{								
1100	12	FE <sub>4</sub> (FF)	IS <sub>4</sub> (FS)	,	<	L	\	l									
1101	13	FE <sub>5</sub> (CR)	IS <sub>3</sub> (GS)	-	=	M	]	m	}								
1110	14	SO	IS <sub>2</sub> (RS)	.	>	N	^	n	-								
1111	15	SI	IS <sub>1</sub> (US)	/	?	O	-	o	DEL								

Note: Do not use the undefined areas.

# Degree of Protection

International protection degrees (IP-□□) are determined by the following tests. Be sure to check the sealing capability under the actual operating environment and conditions before actual use.

- IEC (International Electrotechnical Commission) Standards (IEC60529 November 1989)

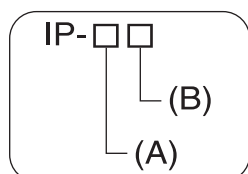







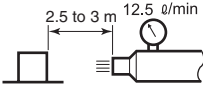

## Degree of Protection from Solid Materials

Degree	Protection	
0		No protection
1		Protects against penetration of any solid object such as a hand that is 50 mm or more in diameter.
2		Protects against penetration of any solid object, such as a finger, that is 12.5 mm or more in diameter.
3		Protects against penetration of any solid object, such as a wire, that is 2.5 mm or more in diameter.
4		Protects against penetration of any solid object, such as a wire, that is 1 mm or more in diameter.
5		Protects against penetration of dust of a quantity that may cause malfunction or obstruct the safe operation of the product.
6		Protects against penetration of all dust.

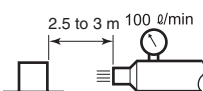
## Degree of Protection Against Water

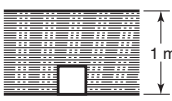
Degree	Protection		Test method (with fresh water)
0	No protection	Not protected against water.	No test
1	Protection against water drops 	Protects against vertical drops of water towards the product.	Water is dropped vertically towards the product from the test machine for 10 min. 
2	Protection against water drops 	Protects against drops of water approaching at a maximum angle of 15° to the left, right, back, and front of vertical towards the product.	Water is dropped for 2.5 min each (i.e., 10 min in total) towards the product inclined 15° to the left, right, back, and front from the test machine. 
3	Protection against sprinkled water 	Protects against sprinkled water approaching at a maximum angle of 60° from vertical towards the product.	Water is sprinkled at a maximum angle of 60° to the left and right from vertical for 10 min from the test machine. 

Degree	Protection		Test method (with fresh water)
4	Protection against water spray 	Protects against water spray approaching at any angle towards the product.	Water is sprayed at any angle towards the product for 10 min from the test machine. 
5	Protection against water jet spray 	Protects against water jet spray approaching at any angle towards the product.	Water is jet sprayed at any angle towards the product for 1 min per square meter for at least 3 min in total from the test machine. Discharging nozzle: 6.3 dia. 
6	Protection against high pressure water jet spray 	Protects against high-pressure water jet spray approaching at any angle towards the product.	Water is jet sprayed at any angle towards the product for 1 min per square meter for at least 3 min in total from the test machine. Discharging nozzle: 12.5 dia. 
7	Protection underwater 	Resists the penetration of water when the product is placed underwater at specified pressure for a specified time.	The product is placed 1 m deep in water (if the product is 850 mm max. in height) for 30 min. 
8	Protection underwater 	Can be used continuously underwater.	The test method is determined by the manufacturer and user.



# Revision History

---

A manual revision code appears as a suffix to the catalog number at the bottom of the front and rear pages.

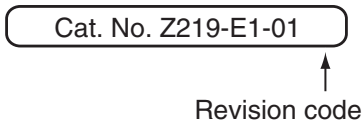

Revision code	Date	Revised contents
A	February 2005	Original production



# Terms and Conditions of Sale

- Offer; Acceptance.** These terms and conditions (these "Terms") are deemed part of all quotes, agreements, purchase orders, acknowledgments, price lists, catalogs, manuals, brochures and other documents, whether electronic or in writing, relating to the sale of products or services (collectively, the "Products") by Omron Electronics LLC and its subsidiary companies ("Omron"). Omron objects to any terms or conditions proposed in Buyer's purchase order or other documents which are inconsistent with, or in addition to, these Terms.
- Prices; Payment Terms.** All prices stated are current, subject to change without notice by Omron. Omron reserves the right to increase or decrease prices on any unshipped portions of outstanding orders. Payments for Products are due net 30 days unless otherwise stated in the invoice.
- Discounts.** Cash discounts, if any, will apply only on the net amount of invoices sent to Buyer after deducting transportation charges, taxes and duties, and will be allowed only if (i) the invoice is paid according to Omron's payment terms and (ii) Buyer has no past due amounts.
- Interest.** Omron, at its option, may charge Buyer 1-1/2% interest per month or the maximum legal rate, whichever is less, on any balance not paid within the stated terms.
- Orders.** Omron will accept no order less than \$200 net billing.
- Governmental Approvals.** Buyer shall be responsible for, and shall bear all costs involved in, obtaining any government approvals required for the importation or sale of the Products.
- Taxes.** All taxes, duties and other governmental charges (other than general real property and income taxes), including any interest or penalties thereon, imposed directly or indirectly on Omron or required to be collected directly or indirectly by Omron for the manufacture, production, sale, delivery, importation, consumption or use of the Products sold hereunder (including customs duties and sales, excise, use, turnover and license taxes) shall be charged to and remitted by Buyer to Omron.
- Financial.** If the financial position of Buyer at any time becomes unsatisfactory to Omron, Omron reserves the right to stop shipments or require satisfactory security or payment in advance. If Buyer fails to make payment or otherwise comply with these Terms or any related agreement, Omron may (without liability and in addition to other remedies) cancel any unshipped portion of Products sold hereunder and stop any Products in transit until Buyer pays all amounts, including amounts payable hereunder, whether or not then due, which are owing to it by Buyer. Buyer shall in any event remain liable for all unpaid accounts.
- Cancellation; Etc.** Orders are not subject to rescheduling or cancellation unless Buyer indemnifies Omron against all related costs or expenses.
- Force Majeure.** Omron shall not be liable for any delay or failure in delivery resulting from causes beyond its control, including earthquakes, fires, floods, strikes or other labor disputes, shortage of labor or materials, accidents to machinery, acts of sabotage, riots, delay in or lack of transportation or the requirements of any government authority.
- Shipping; Delivery.** Unless otherwise expressly agreed in writing by Omron:
  - Shipments shall be by a carrier selected by Omron; Omron will not drop ship except in "break down" situations.
  - Such carrier shall act as the agent of Buyer and delivery to such carrier shall constitute delivery to Buyer;
  - All sales and shipments of Products shall be FOB shipping point (unless otherwise stated in writing by Omron), at which point title and risk of loss shall pass from Omron to Buyer; provided that Omron shall retain a security interest in the Products until the full purchase price is paid;
  - Delivery and shipping dates are estimates only; and
  - Omron will package Products as it deems proper for protection against normal handling and extra charges apply to special conditions.
- Claims.** Any claim by Buyer against Omron for shortage or damage to the Products occurring before delivery to the carrier must be presented in writing to Omron within 30 days of receipt of shipment and include the original transportation bill signed by the carrier noting that the carrier received the Products from Omron in the condition claimed.
- Warranties.** (a) **Exclusive Warranty.** Omron's exclusive warranty is that the Products will be free from defects in materials and workmanship for a period of twelve months from the date of sale by Omron (or such other period expressed in writing by Omron). Omron disclaims all other warranties, express or implied. (b) **Limitations.** OMRON MAKES NO WARRANTY OR REPRESENTATION, EXPRESS OR IMPLIED, ABOUT NON-INFRINGEMENT, MERCHANTABILITY OR FITNESS FOR A PARTICULAR PURPOSE OF THE PRODUCTS. BUYER ACKNOWLEDGES THAT IT ALONE HAS DETERMINED THAT THE PRODUCTS WILL SUITABLY MEET THE REQUIREMENTS OF THEIR INTENDED USE. Omron further disclaims all warranties and responsibility of any type for claims or expenses based on infringement by the Products or otherwise of any intellectual property right. (c) **Buyer Remedy.** Omron's sole obligation hereunder shall be, at Omron's election, to (i) replace (in the form originally shipped with Buyer responsible for labor charges for removal or replacement thereof) the non-complying Product, (ii) repair the non-complying Product, or (iii) repay or credit Buyer an amount equal to the purchase price of the non-complying Product; provided that in no event shall Omron be responsible for warranty, repair, indemnity or any other claims or expenses regarding the Products unless Omron's analysis confirms that the Products were properly handled, stored, installed and maintained and not subject to contamination, abuse, misuse or inappropriate modification. Return of any Products by Buyer must be approved in writing by Omron before shipment. Omron Companies shall not be liable for the suitability or unsuitability or the results from the use of Products in combination with any electrical or electronic components, circuits, system assemblies or any other materials or substances or environments. Any advice, recommendations or information given orally or in writing, are not to be construed as an amendment or addition to the above warranty. See <http://oeweb.omron.com> or contact your Omron representative for published information.
- Limitation on Liability; Etc.** OMRON COMPANIES SHALL NOT BE LIABLE FOR SPECIAL, INDIRECT, INCIDENTAL, OR CONSEQUENTIAL DAMAGES, LOSS OF PROFITS OR PRODUCTION OR COMMERCIAL LOSS IN ANY WAY CONNECTED WITH THE PRODUCTS, WHETHER SUCH CLAIM IS BASED IN CONTRACT, WARRANTY, NEGLIGENCE OR STRICT LIABILITY. Further, in no event shall liability of Omron Companies exceed the individual price of the Product on which liability is asserted.
- Indemnities.** Buyer shall indemnify and hold harmless Omron Companies and their employees from and against all liabilities, losses, claims, costs and expenses (including attorney's fees and expenses) related to any claim, investigation, litigation or proceeding (whether or not Omron is a party) which arises or is alleged to arise from Buyer's acts or omissions under these Terms or in any way with respect to the Products. Without limiting the foregoing, Buyer (at its own expense) shall indemnify and hold harmless Omron and defend or settle any action brought against such Companies to the extent based on a claim that any Product made to Buyer specifications infringed intellectual property rights of another party.
- Property; Confidentiality.** Any intellectual property in the Products is the exclusive property of Omron Companies and Buyer shall not attempt to duplicate it in any way without the written permission of Omron. Notwithstanding any charges to Buyer for engineering or tooling, all engineering and tooling shall remain the exclusive property of Omron. All information and materials supplied by Omron to Buyer relating to the Products are confidential and proprietary, and Buyer shall limit distribution thereof to its trusted employees and strictly prevent disclosure to any third party.
- Export Controls.** Buyer shall comply with all applicable laws, regulations and licenses regarding (i) export of products or information; (ii) sale of products to "forbidden" or other proscribed persons; and (iii) disclosure to non-citizens of regulated technology or information.
- Miscellaneous.** (a) **Waiver.** No failure or delay by Omron in exercising any right and no course of dealing between Buyer and Omron shall operate as a waiver of rights by Omron. (b) **Assignment.** Buyer may not assign its rights hereunder without Omron's written consent. (c) **Law.** These Terms are governed by the law of the jurisdiction of the home office of the Omron company from which Buyer is purchasing the Products (without regard to conflict of law principles). (d) **Amendment.** These Terms constitute the entire agreement between Buyer and Omron relating to the Products, and no provision may be changed or waived unless in writing signed by the parties. (e) **Severability.** If any provision hereof is rendered ineffective or invalid, such provision shall not invalidate any other provision. (f) **Setoff.** Buyer shall have no right to set off any amounts against the amount owing in respect of this invoice. (g) **Definitions.** As used herein, "including" means "including without limitation"; and "Omron Companies" (or similar words) mean Omron Corporation and any direct or indirect subsidiary or affiliate thereof.

## Certain Precautions on Specifications and Use

- Suitability of Use.** Omron Companies shall not be responsible for conformity with any standards, codes or regulations which apply to the combination of the Product in the Buyer's application or use of the Product. At Buyer's request, Omron will provide applicable third party certification documents identifying ratings and limitations of use which apply to the Product. This information by itself is not sufficient for a complete determination of the suitability of the Product in combination with the end product, machine, system, or other application or use. Buyer shall be solely responsible for determining appropriateness of the particular Product with respect to Buyer's application, product or system. Buyer shall take application responsibility in all cases but the following is a non-exhaustive list of applications for which particular attention must be given:
  - Outdoor use, uses involving potential chemical contamination or electrical interference, or conditions or uses not described in this document.
  - Use in consumer products or any use in significant quantities.
  - Energy control systems, combustion systems, railroad systems, aviation systems, medical equipment, amusement machines, vehicles, safety equipment, and installations subject to separate industry or government regulations.
  - Systems, machines and equipment that could present a risk to life or property. Please know and observe all prohibitions of use applicable to this Product.

NEVER USE THE PRODUCT FOR AN APPLICATION INVOLVING SERIOUS RISK TO LIFE OR PROPERTY OR IN LARGE QUANTITIES WITHOUT ENSURING THAT THE SYSTEM AS A WHOLE HAS BEEN DESIGNED TO ADDRESS THE RISKS, AND THAT THE OMRON'S PRODUCT IS PROPERLY RATED AND INSTALLED FOR THE INTENDED USE WITHIN THE OVERALL EQUIPMENT OR SYSTEM.
- Programmable Products.** Omron Companies shall not be responsible for the user's programming of a programmable Product, or any consequence thereof.
- Performance Data.** Data presented in Omron Company websites, catalogs and other materials is provided as a guide for the user in determining suitability and does not constitute a warranty. It may represent the result of Omron's test conditions, and the user must correlate it to actual application requirements. Actual performance is subject to the Omron's Warranty and Limitations of Liability.
- Change in Specifications.** Product specifications and accessories may be changed at any time based on improvements and other reasons. It is our practice to change part numbers when published ratings or features are changed, or when significant construction changes are made. However, some specifications of the Product may be changed without any notice. When in doubt, special part numbers may be assigned to fix or establish key specifications for your application. Please consult with your Omron's representative at any time to confirm actual specifications of purchased Product.
- Errors and Omissions.** Information presented by Omron Companies has been checked and is believed to be accurate; however, no responsibility is assumed for clerical, typographical or proofreading errors or omissions.



## OMRON ELECTRONICS LLC

1 Commerce Drive  
Schaumburg, IL 60173  
847.843.7900  
For US technical support or  
other inquiries: 800.556.6766

## OMRON CANADA, INC.

885 Milner Avenue  
Toronto, Ontario M1B 5V8  
416.286.6465

## OMRON ON-LINE

Global - <http://www.omron.com>  
USA - <http://www.omron.com/oei>  
Canada - <http://www.omron.ca>

### UNITED STATES

To locate a Regional Sales Office, local Distributor or  
to obtain product information, call: 847.843.7900

### CANADA REGIONAL SALES OFFICES

<b>Ontario</b>	Toronto	416.286.6465
	Kitchener	519.896.1144
	Kingston	613.376.3968
<b>Quebec</b>	Montreal	514.636.6676
<b>British Columbia</b>	Vancouver	604.522.8855
<b>Alberta</b>	Edmonton	403.440.0818
	Calgary	403.257.3095

### BRAZIL SALES OFFICE

**Sao Paulo** 55.11.5564.6488

### ARGENTINA SALES OFFICE

**Cono Sur** 54.114.787.1129

### MEXICO SALES OFFICES

**Florida** 954.227.2121      **Ciudad Juarez** 656.623.7083  
**Mexico, D.F.** 555.534.1195      **Monterrey, N.L.** 818.377.4281