

RFID System

# V680 Series

User's Manual

ID Controller

V680-CA5D01-V2  
V680-CA5D02-V2

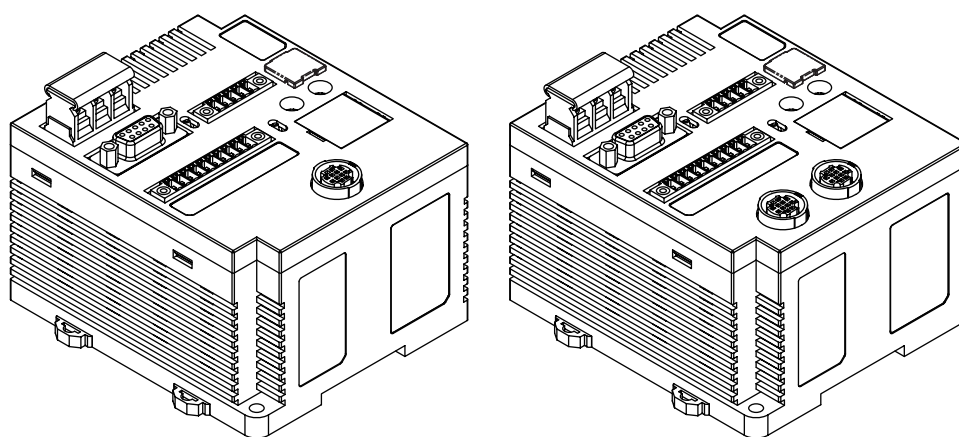

# Introduction

---

Thank you for purchasing a V680-series RFID System. This manual describes the functions, performance, and application methods needed for optimum use of the V680-series RFID System.

Please observe the following items when using the RFID System.

- Allow the RFID System to be installed and operated only by qualified specialist with a sufficient knowledge of electrical systems.
- Read and understand this manual before attempting to use the RFID System and use the RFID System correctly.
- Keep this manual in a safe and accessible location so that it is available for reference when required.

Introduction	READ AND UNDERSTAND THIS DOCUMENT	Introduction
SECTION 1	Product Overview	SECTION 1
SECTION 2	Installation, Connections, and Wiring	SECTION 2
SECTION 3	Preparations for Communications	SECTION 3
SECTION 4	Functions	SECTION 4
SECTION 5	Communications	SECTION 5
SECTION 6	Troubleshooting	SECTION 6
SECTION 7	Appendices	SECTION 7

## RFID System

V680-CA5D01-V2  
V680-CA5D02-V2

ID Controller  
ID Controller

## User's Manual

## READ AND UNDERSTAND THIS DOCUMENT

Please read and understand this document before using the products. Please consult your OMRON representative if you have any questions or comments.

### WARRANTY

OMRON's exclusive warranty is that the products are free from defects in materials and workmanship for a period of one year (or other period if specified) from date of sale by OMRON.

OMRON MAKES NO WARRANTY OR REPRESENTATION, EXPRESS OR IMPLIED, REGARDING NON-INFRINGEMENT, MERCHANTABILITY, OR FITNESS FOR PARTICULAR PURPOSE OF THE PRODUCTS. ANY BUYER OR USER ACKNOWLEDGES THAT THE BUYER OR USER ALONE HAS DETERMINED THAT THE PRODUCTS WILL SUITABLY MEET THE REQUIREMENTS OF THEIR INTENDED USE. OMRON DISCLAIMS ALL OTHER WARRANTIES, EXPRESS OR IMPLIED.

### LIMITATIONS OF LIABILITY

OMRON SHALL NOT BE RESPONSIBLE FOR SPECIAL, INDIRECT, OR CONSEQUENTIAL DAMAGES, LOSS OF PROFITS OR COMMERCIAL LOSS IN ANY WAY CONNECTED WITH THE PRODUCTS, WHETHER SUCH CLAIM IS BASED ON CONTRACT, WARRANTY, NEGLIGENCE, OR STRICT LIABILITY.

In no event shall responsibility of OMRON for any act exceed the individual price of the product on which liability is asserted.

IN NO EVENT SHALL OMRON BE RESPONSIBLE FOR WARRANTY, REPAIR, OR OTHER CLAIMS REGARDING THE PRODUCTS UNLESS OMRON'S ANALYSIS CONFIRMS THAT THE PRODUCTS WERE PROPERLY HANDLED, STORED, INSTALLED, AND MAINTAINED AND NOT SUBJECT TO CONTAMINATION, ABUSE, MISUSE, OR INAPPROPRIATE MODIFICATION OR REPAIR.

### SUITABILITY FOR USE

THE PRODUCTS CONTAINED IN THIS DOCUMENT ARE NOT SAFETY RATED. THEY ARE NOT DESIGNED OR RATED FOR ENSURING SAFETY OF PERSONS, AND SHOULD NOT BE RELIED UPON AS A SAFETY COMPONENT OR PROTECTIVE DEVICE FOR SUCH PURPOSES. Please refer to separate catalogs for OMRON's safety rated products.

OMRON shall not be responsible for conformity with any standards, codes, or regulations that apply to the combination of products in the customer's application or use of the product.

At the customer's request, OMRON will provide applicable third party certification documents identifying ratings and limitations of use that apply to the products. This information by itself is not sufficient for a complete determination of the suitability of the products in combination with the end product, machine, system, or other application or use.

The following are some examples of applications for which particular attention must be given. This is not intended to be an exhaustive list of all possible uses of the products, nor is it intended to imply that the uses listed may be suitable for the products:

- Outdoor use, uses involving potential chemical contamination or electrical interference, or conditions or uses not described in this document.
- Nuclear energy control systems, combustion systems, railroad systems, aviation systems, medical equipment, amusement machines, vehicles, safety equipment, and installations subject to separate industry or government regulations.
- Systems, machines, and equipment that could present a risk to life or property.

Please know and observe all prohibitions of use applicable to the products.

NEVER USE THE PRODUCTS FOR AN APPLICATION INVOLVING SERIOUS RISK TO LIFE OR PROPERTY WITHOUT ENSURING THAT THE SYSTEM AS A WHOLE HAS BEEN DESIGNED TO ADDRESS THE RISKS, AND THAT THE OMRON PRODUCT IS PROPERLY RATED AND INSTALLED FOR THE INTENDED USE WITHIN THE OVERALL EQUIPMENT OR SYSTEM.

### PERFORMANCE DATA

Performance data given in this document is provided as a guide for the user in determining suitability and does not constitute a warranty. It may represent the result of OMRON's test conditions, and the users must correlate it to actual application requirements. Actual performance is subject to the OMRON Warranty and Limitations of Liability.

### CHANGE IN SPECIFICATIONS

Product specifications and accessories may be changed at any time based on improvements and other reasons.

It is our practice to change model numbers when published ratings or features are changed, or when significant construction changes are made. However, some specifications of the product may be changed without any notice. When in doubt, special model numbers may be assigned to fix or establish key specifications for your application on your request. Please consult with your OMRON representative at any time to confirm actual specifications of purchased products.

### DIMENSIONS AND WEIGHTS

Dimensions and weights are nominal and are not to be used for manufacturing purposes, even when tolerances are shown.

### ERRORS AND OMISSIONS

The information in this document has been carefully checked and is believed to be accurate; however, no responsibility is assumed for clerical, typographical, or proofreading errors, or omissions.

### PROGRAMMABLE PRODUCTS

OMRON shall not be responsible for the user's programming of a programmable product, or any consequence thereof.

### COPYRIGHT AND COPY PERMISSION

This document shall not be copied for sales or promotions without permission. This document is protected by copyright and is intended solely for use in conjunction with the product. Please notify us before copying or reproducing this document in any manner, for any other purpose. If copying or transmitting this document to another, please copy or transmit it in its entirety.

## Safety Precautions

### ● Alert Symbols for Safe Use

The following symbols are used in this manual to indicate precautions that must be observed to ensure safe use of the V680-CA5D01-V2 / -CA5D02-V2. The precautions provided here contain important safety information. Be sure to observe these precautions.

The following signal words are used in this manual.



Indicates a potentially hazardous situation which, if not avoided, will result in minor or moderate injury, or may result in serious injury or death. Additionally, there may be significant property damage.

### ● Meanings of Alert Symbols



Indicates general prohibitions for which there is no specific symbol.

### ● Warning



This Product is not designed to be used either directly or indirectly in applications that detect human presence for the purpose of maintaining safety. Do not use this Product as a sensing device for protecting human lives.



## Regulations and Standards

The V680-CA5D01-V2 / -CA5D02-V2 conform to the following overseas regulations and standards.

### 1. UL Standards

The V680-CA5D01-V2 and V680-CA5D02-V2 meet UL (Underwriter's Laboratories Inc.) conditions.

UL508



Connect to either circuit type (1) or (2) listed below.

#### (1) Limited Voltage/Current Circuit (Approved under UL508)

A circuit that uses the secondary windings of an isolation transformer as its power supply and fulfills the following conditions:

- Maximum voltage: 30 Vrms (42.4 V peak)  
and
- Maximum current: (a) 8 A (including short-circuits) or  
(b) Current limited by a circuit protection device (e.g., fuse) with the ratings listed in the following table.

No-load voltage (V peak)	Maximum current rating (A)
0 to 20	5.0
Over 20 to 30	100 Peak voltage

(2) A class 2 circuit with a maximum voltage of 30 Vrms (42.4 V peak) that uses a class 2 power supply unit conforming to UL1310 or a class 2 transformer that conforms to UL1585 as its power source.

## 2. EMC Standards

The V680-CA5D01-V2 and V680-CA5D02-V2 meet the requirements of the following EC Directives.

EMC Standard: EN 61000-6-2

EN 61000-6-4

## Precautions for Safe Use

Be sure to observe the following precautions to ensure safe use of the Product.

1. Do not use the Product in environments with flammable, explosive, or corrosive gasses.
2. Do not attempt to disassemble, repair, or modify the Product.
3. Tighten the base mounting screws and terminal block screws securely.
4. Be sure to use crimp terminals of the specified size for wiring.
5. If any cable has a locking mechanism, make sure that it has been locked before using the cable.
6. Make sure the power supplied by the DC power supply unit is within the rated power supply voltage (24 VDC +10%/–15%) before using the Product.
7. Do not connect the power supply in reverse.
8. Do not allow water or wires to enter the Product through gaps in the case. Otherwise, fire or electric shock may occur.
9. Turn OFF the power to the Controller before attaching or removing an Amplifier or Antenna.
10. If an error is detected in the Product, immediately stop operation and turn OFF the power supply.  
Consult with an OMRON representative.
11. Dispose of the Product as industrial waste.
12. Observe all warnings and precautions given in the body of this manual.

## Precautions for Correct Use

Always observe the following precautions to prevent operation failure, malfunctions, and adverse effects on performance and equipment.

### 1. Installation Environment

Do not use the Product in the following locations.

- Locations exposed to corrosive gases, dust, metallic powder, or salts
- Locations not within the specified operating temperature range
- Locations subject to rapid changes in temperature or condensation
- Locations not within the specified operating humidity range
- Locations subject to direct vibration or shock outside the specified ranges
- Locations subject to spray of water, oil, or chemicals

### 2. Installation

- This Product uses a frequency band of 13.56 MHz to communicate with ID Tags. Some transceivers, motors, inverters, switching power supplies, etc., generate electrical noise that will affect these communications. If any of these devices are located in the vicinity of the Product, they may affect communications with ID Tags, and may possibly damage the ID Tags. Prior to using the Product in the vicinity of any of these devices, perform a test to determine whether the Product can be used under the resulting influence.
- Observe the following precautions to minimize the effects of normal noise.
  - (1) Ground the ground terminal on the Product and all metal objects in the vicinity of the Product to 100  $\Omega$  or less.
  - (2) Do not use the Product near high-voltage or high-current lines.
- The Product is not waterproof. Do not use it in an environment where mist is present.
- Do not expose the Product to chemicals that adversely affect the Product materials.
- Use a tightening torque of 1.2 N·m max.
- If multiple Antennas are mounted near each other, communications performance may decrease due to mutual interference. Refer to *Installing Antennas* in the *V680 Series User's Manual for Amplifiers, Antennas, and ID Tags* (Cat. No. Z262, Z248) and check to make sure there is no mutual interference.

### 3. Storage

Do not store the Product in the following locations.

- Locations exposed to corrosive gases, dust, metallic powder, or salts
- Locations not within the specified operating temperature range
- Locations subject to rapid changes in temperature or condensation
- Locations not within the specified storage humidity range
- Locations subject to direct vibration or shock outside the specified ranges
- Locations subject to spray of water, oil, or chemicals

### 4. Cleaning

- Do not clean the Product with paint thinner, benzene, acetone, or kerosene. These chemicals will dissolve the resin materials and case coating.

## 5. Communications with the Host Device

Communicate with the host device only after confirming that the CIDRW Controller has started. Also, unstable signals may occur at the host interface when the CIDRW Controller is started. When initializing operation, clear the reception buffer at the host device or take other suitable methods to clear unwanted signals.

## 6. Startup Precaution

Never turn OFF the power supply while the CIDRW Controller is starting, including when power is turned ON, when the mode is changed, or when the CIDRW Controller is being reset. Doing so may damage the CIDRW Controller.

## Meanings of Symbols

---



Indicates particularly important points related to a function, including precautions and application advice.



Indicates page numbers containing relevant information.



Indicates reference to helpful information and explanations for difficult terminology.



# Table of Contents

---

## Introduction

Safety Precautions	3
Regulations and Standards	3
Precautions for Safe Use	4
Precautions for Correct Use	5
Meanings of Symbols	6
Table of Contents	7

## SECTION 1 Product Overview **9**

Features	10
Part Names and Functions	13
System Configuration	19
Application Flowchart	25

## SECTION 2 Installation, Connections, and Wiring **27**

Installation	28
Connection and Wiring	30

## SECTION 3 Preparations for Communications **57**

Switch Settings	58
Trial Operation	76

## SECTION 4 Functions **79**

Trigger Input	80
Write Protection	81
Tag Service Life Check	91
Tag Memory Check	93
Tag Memory Error Correction	94
Write Command Memory	95
Noise Monitor Function	96

<b>SECTION 5 Communications</b>	<b>97</b>
Tag Operation and Command Status	98
V600-V680 Command Correspondence	101
V680 Commands	103
V600 Commands	172
<b>SECTION 6 Troubleshooting</b>	<b>237</b>
Self-diagnostic Function	238
Error Lists	240
Errors and Countermeasures	244
Maintenance and Inspection	245
Troubleshooting	246
<b>SECTION 7 Appendices</b>	<b>251</b>
Specifications and Dimensions	252
Characteristics According to Operating Conditions	256
Tag Memory Map	265
Tag Memory Capacity and Memory Type	266
ASCII Table	267
Degree of Protection	268
Revision History	270

# SECTION 1

## Product Overview

❏ Features	10
❏ Part Names and Functions	13
❏ System Configuration	19
❏ Application Flowchart	25

## Features

The V680-CA5D01-V2 / -CA5D02-V2 ID Controllers connect to V680-HA63 Amplifiers and V680-HS□□ Antennas, or to V680-H01 Antennas, to read and write data for V680-series ID Tags according to commands from the host device. The ID Controller returns the results of executing these commands as responses to the host device.



The ID Controller can communicate with Tags that conform to ISO 18000-3 (ISO 15693). The ID Controller may not be able to communicate with Tags that are not V680-series Tags. Always confirm that communications are possible in advance.

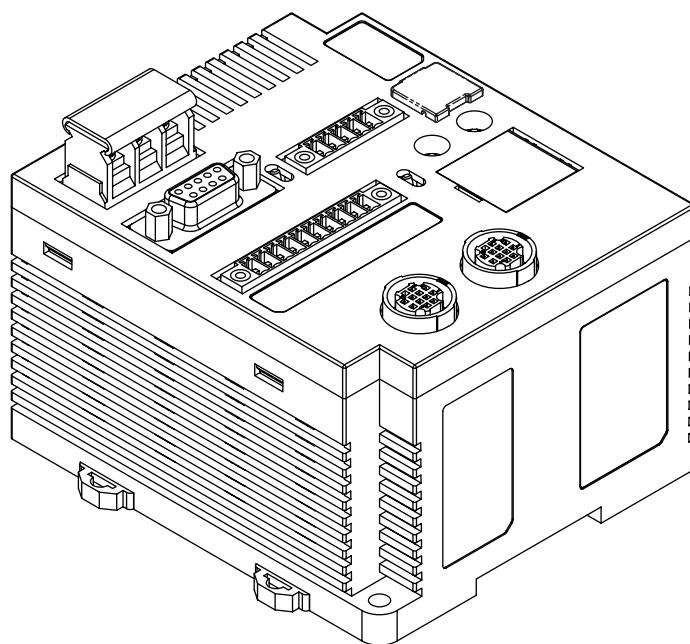

■ Differences between the V680-CA5D□□ and V680-CA5D□□-V2

The following functions have been added to the V680-CA5D□□-V2 in addition to those found on the V680-CA5D□□. These functions are upward-compatible with the V680-CA5D□□, so the V680-CA5D□□ can be directly replaced by the V680-CA5D□□-V2.

■ New Commands Added

The following commands have been added.

READ TAG MEMORY ERROR CORRECTION	QR	Reads the Tag's memory contents. Also uses a memory check code to inspect data reliability.
WRITE TAG MEMORY ERROR CORRECTION	QW	Writes data to the memory of the Tag. Also writes the memory check code for the data reliability inspection to the memory of the Tag.
READ ID	ID	Reads the Tag's ID code.
UID ADDITION SET	US	Sets whether or not UID should be added to the read command (RD) response.

■ Communications Designations Added

Multi-access, FIFO, and selective have been added to the communications designations.

**Note:** These designations cannot be used for communications with the V680-D1KP□□.

■ V680-H01 Antenna Connection Supported

The V680-H01 Antenna can be used by setting DIP SW4, pin 8.



The V680-H01 Antenna can be connected only to the V680-CA5D01-V2 ID Controller. It cannot be used with the V680-CA5D02-V2 ID Controller.

■ High-speed Data Transmission Supported

High-speed data transmission is possible by setting DIP SW4, pin 10.



The high-speed mode cannot be used with the V680-H01 Antenna.

DIP SW4

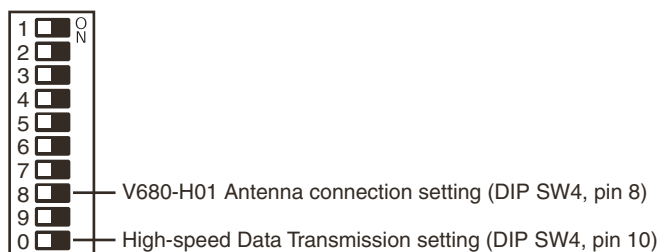

■ Differences between Version 2.0 and Version 2.1 and Newer

The following functions have been added to version 2.1 and newer models in addition to those found on version 2.0. These functions are upward-compatible with version 2.0, so version 2.0 can be directly replaced with version 2.1.

- **Parameter Added to V600SP Command**  
A write protect method has been added to the V600SP command.
  
- **Write Protect Method Added**  
The above-mentioned V600SP command can be set in the V600 command format to use the V600 EEPROM write protection method or the V600 S-RAM write protection method.

# Part Names and Functions

## ■ Part Names

### ■ V680-CA5D01-V2

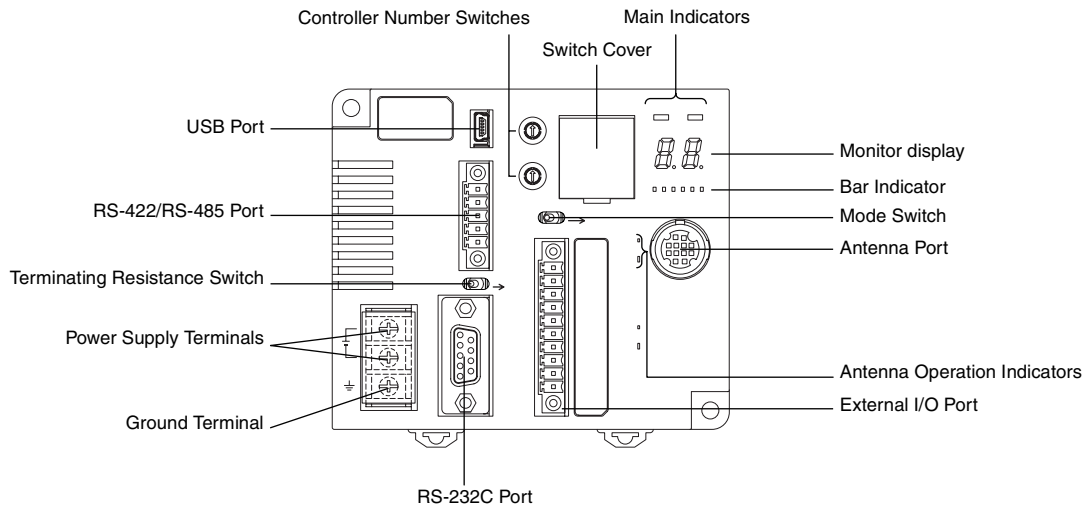

### ■ V680-CA5D02-V2

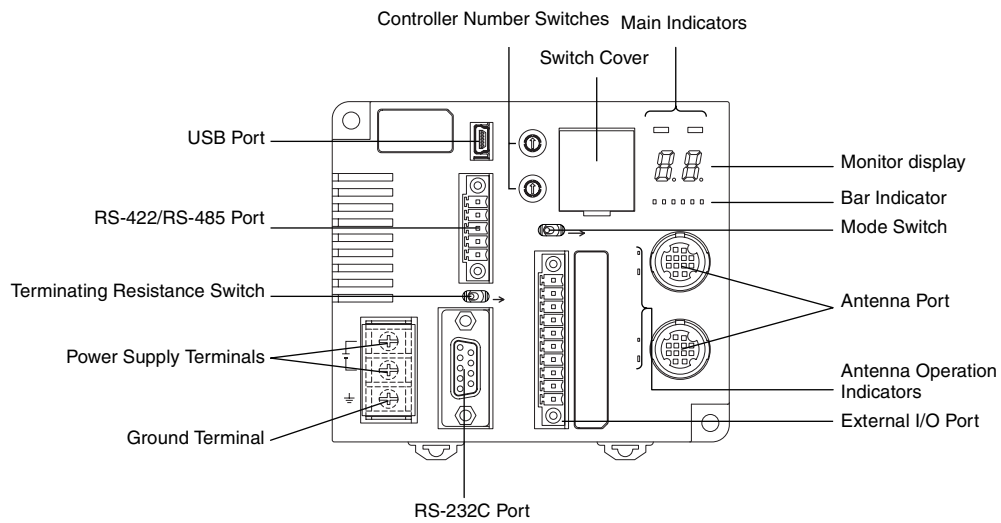

## ■ Power Supply and Ground Terminals

Description	Description
Power supply terminals	Supply 24 VDC power to these terminals. Recommended power supply: OMRON S8VS-03024.
Ground terminal	The ground terminal. Connect this terminal to an independent ground line connected to 100 Ω or less.

## ■ External I/O Port

The external I/O port is used to connect external I/O signals.

There are two external I/O signal arrangements that can be used for the same port: the same signal arrangement as the V600-CA5D□□ and a signal arrangement unique to the V680-CA5D□□-V2.

The desired I/O signal arrangement can be specified using the PARAMETER SET (SP) command. In Self-execution Mode, the use of ports other than RUN and RST can be set.

Description		Description
V600 I/O	V680 I/O	
RUN		Turns ON when the ID Controller is operating normally and the communications are possible with the host device.
BUSY	OUT3	BUSY: Output from when a tag communications command is received from the host device until tag communications have been completed. This is the default setting. OUT3: User output 3. This output can be controlled with the CONTROLLER CONTROL (CC) command.
ERROR	OUT4	ERROR: Output for 500 ms when a tag communications error, host communications error, or hardware error has occurred. The output time can be changed with the PARAMETER SET (SP) command. This is the default setting. OUT4: User output 4. This output can be controlled with the CONTROLLER CONTROL (CC) command.
OUT1		OUT1: User output 1. This output can be controlled with the CONTROLLER CONTROL (CC) command.
OUT2		OUT2: User output 2. This output can be controlled with the CONTROLLER CONTROL (CC) command.
COM_O		Common terminal for outputs.
RST		External reset input for emergency stops. The ID Controller is reset when an input is received.
TRG1		<b>V680 Command System</b> If a trigger communications designation (SI, RI, or PI) is specified, the command received by Antenna 1 will be executed on the rising edge of the TRG1 input. If any other communications designation is specified, TRG1 is used as user input 1, which can be read using the CONTROLLER CONTROL (CC) command. <b>V600 Command System</b> If pin 6 on DIP switch SW4 (Lower Trigger Execution Setting) is turned ON, any command already received by Antenna 1 will be executed on the rising edge of the TRG1 Input. If pin 6 is turned OFF, TRG1 is used as user input 1, which can be read using the CONTROLLER CONTROL (CC) command.
TRG2		<b>V680 Command System</b> If a trigger communications designation (SI, RI, or PI) is specified, the command received by Antenna 2 will be executed on the rising edge of the TRG2 input. If any other communications designation is specified, TRG2 is used as user input 2, which can be read using the CONTROLLER CONTROL (CC) command. <b>V600 Command System</b> If pin 6 on DIP switch SW4 (Lower Trigger Execution Setting) is turned ON, any command already received by Antenna 2 will be executed on the rising edge of the TRG2 input. If pin 6 is turned OFF, TRG2 is used as user input 2, which can be read using the CONTROLLER CONTROL (CC) command.
COM_I		Common terminal for inputs



## ■ RS-232C Port

The RS-232C port is used to communicate with a host device. A computer, PLC, or similar host device with an RS-232C interface can be connected.

## ■ RS-422/RS-485 Port

The RS-422/RS-485 port is used to communicate with a host device. Computers, PLCs, and similar host devices with RS-422/RS-485 interfaces can be connected.

## ■ USB Port

The USB port is used to connect to a computer via a USB cable. The port is USB 1.1. Communications with host devices using USB connections can be made using only 1:1 protocol, regardless of the setting of pin 9 on DIP switch SW3.



The USB port is not a control port. Always use the RS-232C port or RS-422/RS-485 port when building systems.



p. 19

CHECK!

## ■ Antenna Port

The antenna port is used to connect V680-series Amplifiers and Antennas.

## ■ Controller Number Switches

The Controller number switches are used to set the number of the ID Controller when connecting more than one ID Controller to one host device.



Refer to *Controller Number Switch Settings (SW1, SW2)* for details on this switch.



p. 60

CHECK!

## ■ Switch Cover

There are two DIP switches behind the switch cover for making settings.



Refer to *DIP Switch Settings (SW3, SW4)* for details on these switches.



p. 61

CHECK!

## ■ Mode Switch

The mode switch is used to change the ID Controller's operation mode (between Run and Maintenance Mode).



Refer to *Mode Switch Setting* for details on this switch.



p. 63

CHECK!

## ■ Terminating Resistance Switch

This switch can be used to connect or disconnect the internal terminating resistance.



Refer to *Terminating Resistance* for details on this switch.



p. 63

CHECK!

■ **Main Indicators**

Indicator	Color	Description
RUN/RST	Green	Lit while the ID Controller is operating normally.
	Red	Lit while external reset signal is being input.
COMM	Green	Lit during normal communications with a host device.
	Red	Lit when an error is detected for communications with a host device.

■ **Antenna Operation Indicators**

Indicator	Color	Description
COMM1	Yellow	Lit during processing of commands for Tag communications by Antenna 1.
NORM1/ ERR1	Green	Lights once upon normal completion of processing by Antenna 1.
	Red	Lights once when processing ends in an error at Antenna 1.
COMM2 (See note.)	Yellow	Lit during processing of commands for communications with Tags by Antenna 2.
NORM2/ ERR2 (See note.)	Green	Lights once upon normal completion of processing by Antenna 2.
	Red	Lights once when processing ends in an error at Antenna 2.

**Note:** The V680-CA5D01-V2 does not have COMM2 or NORM2/ERR2 indicators.

■ **Monitor Display**

Indicator	Color	Mode	Description	
7-segment display (2 digits)	Red	Run Mode	Command Execution Mode	Displays end codes.
			Self-execution Mode	
		Maintenance Mode	Distance Level Measurement Mode	Converts and measures the Antenna output at six levels. The level is displayed as either "EE" or 01 to 06. "--" will be displayed if there is no Tag in the Antenna's communications area.
			Tag Communications Test Mode	Communicates with Tags and displays end codes.  p. 147
			Speed Level Measurement Mode (read/write)	Repeatedly communicates with moving Tags and displays the number of successful communications between 01 and 99. The display will show 99 even if more than 99 successful communications were made. "EE" will be displayed if the first communication after the Tag entered the communications area fails.
			Noise Level Measurement Mode	Displays the ambient noise level between 00 and 99.
		Communications Success Rate Measurement Mode	Communicates 100 times with a Tag with no retries, and displays the communications success rate between 01 and 99 (%). If no communications were successful, "EE" is displayed. If all communications were successful, "FF" is displayed.	

▪ Run Mode (SW5 OFF)

In Run Mode, the end codes for command processing is displayed. The end code is displayed in 2-digit hexadecimal, as shown below.

The display is lit for normal and warning responses and flashes for error responses.

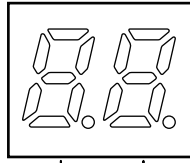

Hexa-decimal	0	1	2	3	4	5	6	7	8	9	A	B	C	D	E	F
Display	0	1	2	3	4	5	6	7	8	9	A	B	C	D	E	F



The error code “15” will be displayed if the operation conditions have not been set and operation is switched to Self-execution Mode.

▪ Maintenance Mode (SW5 ON)

In Maintenance Mode, the measurement results for each measurement mode is displayed in 2-digit decimal.

▪ Checking the Version

The version can be checked on the monitor display when turning ON the power.

Checking Method (example shows version 2.1)

1. Turn ON the power for the V680-CA5D0□-V2.
2. The following appears on the monitor display.

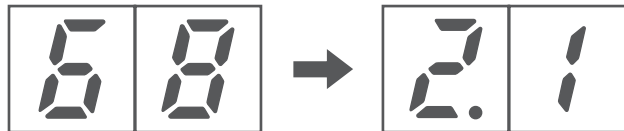

■ Bar Indicator

Indicator	Color	Description	
1	Yellow	The Antenna and the Tag are far apart.	The Tag travel speed is fast.
2	Yellow		↑
3	Yellow	↓	↓
4	Yellow		↓
5	Yellow	The Antenna and Tag are close.	↓
6	Yellow		The Tag travel speed is slow.

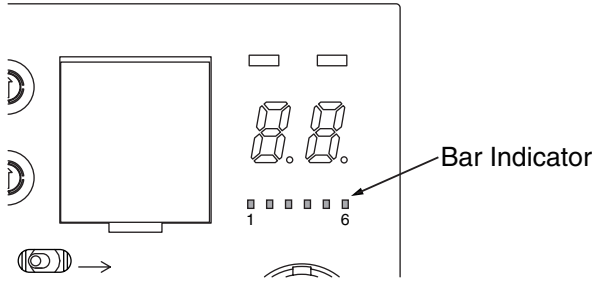

# System Configuration

## 1:1 Connection

One host device is connected via the RS-232C, RS-422, or RS-485 interface.

- Using an Antenna Other than the V680-H01

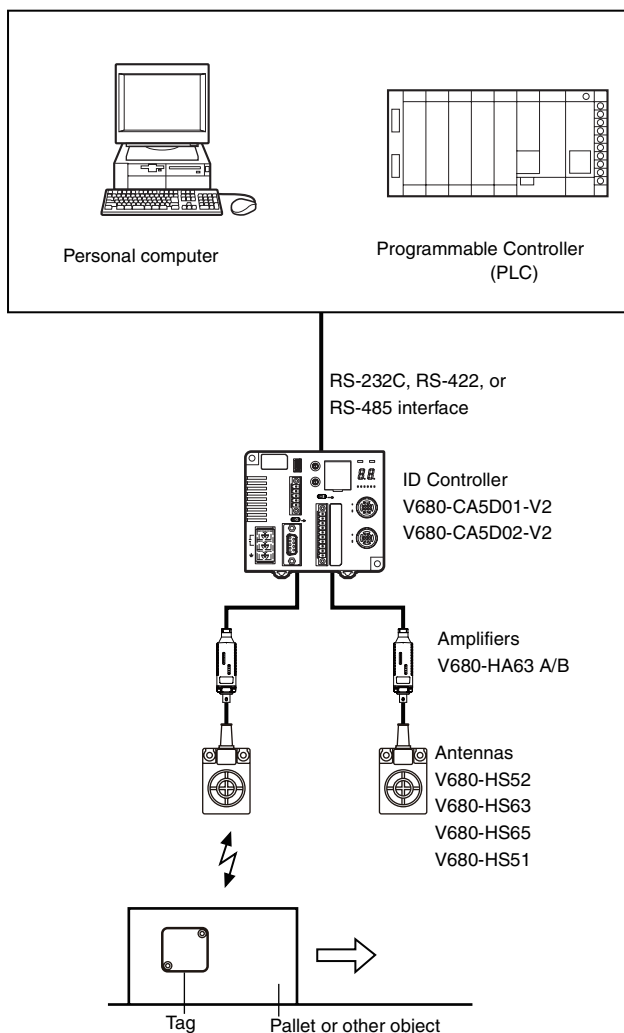

- Using a V680-H01 Antenna

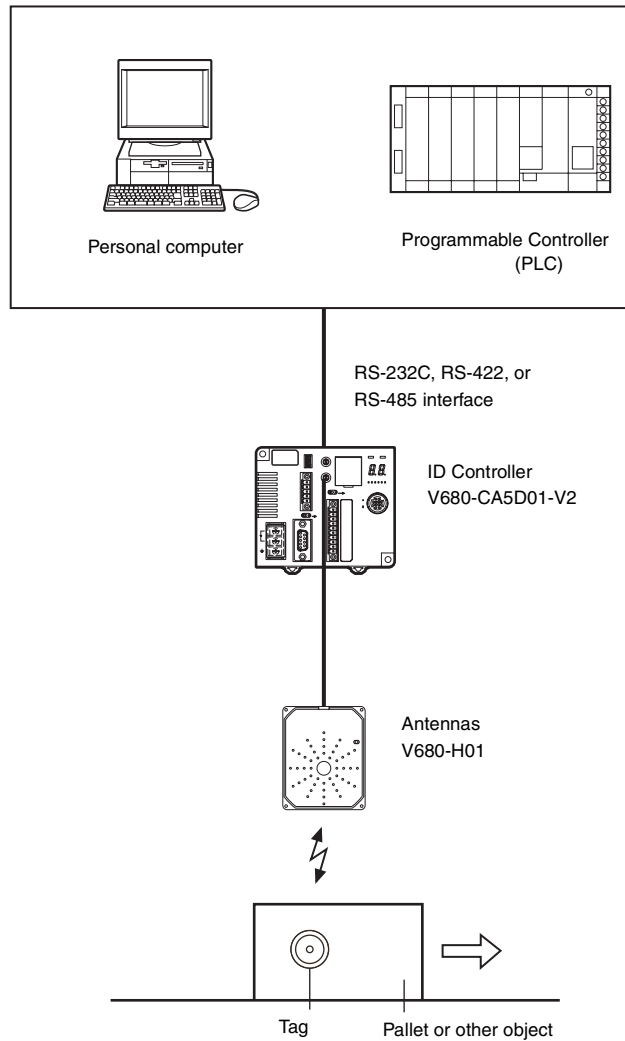

The V680-H01 Antenna can be connected only to the V680-CA5D01-V2 ID Controller. It cannot be used with the V680-CA5D02-V2 ID Controller

## 1:N Connections with RS-232C Connection to Host Device

The host device can be connected via RS-232C and then other ID Controllers can be connected via RS-422/RS-485 interfaces.

- Using an Antenna Other than the V680-H01

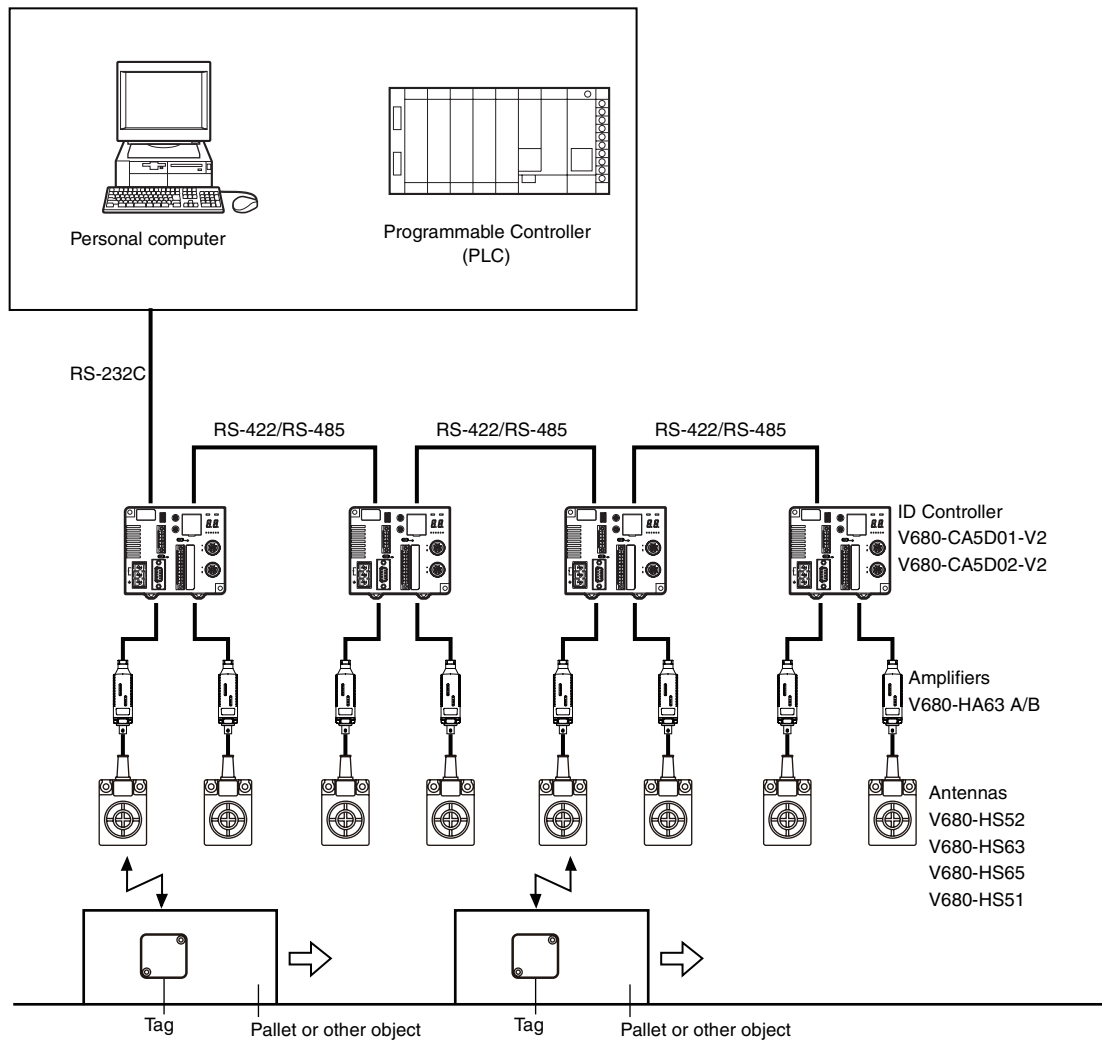

- Using a V680-H01 Antenna

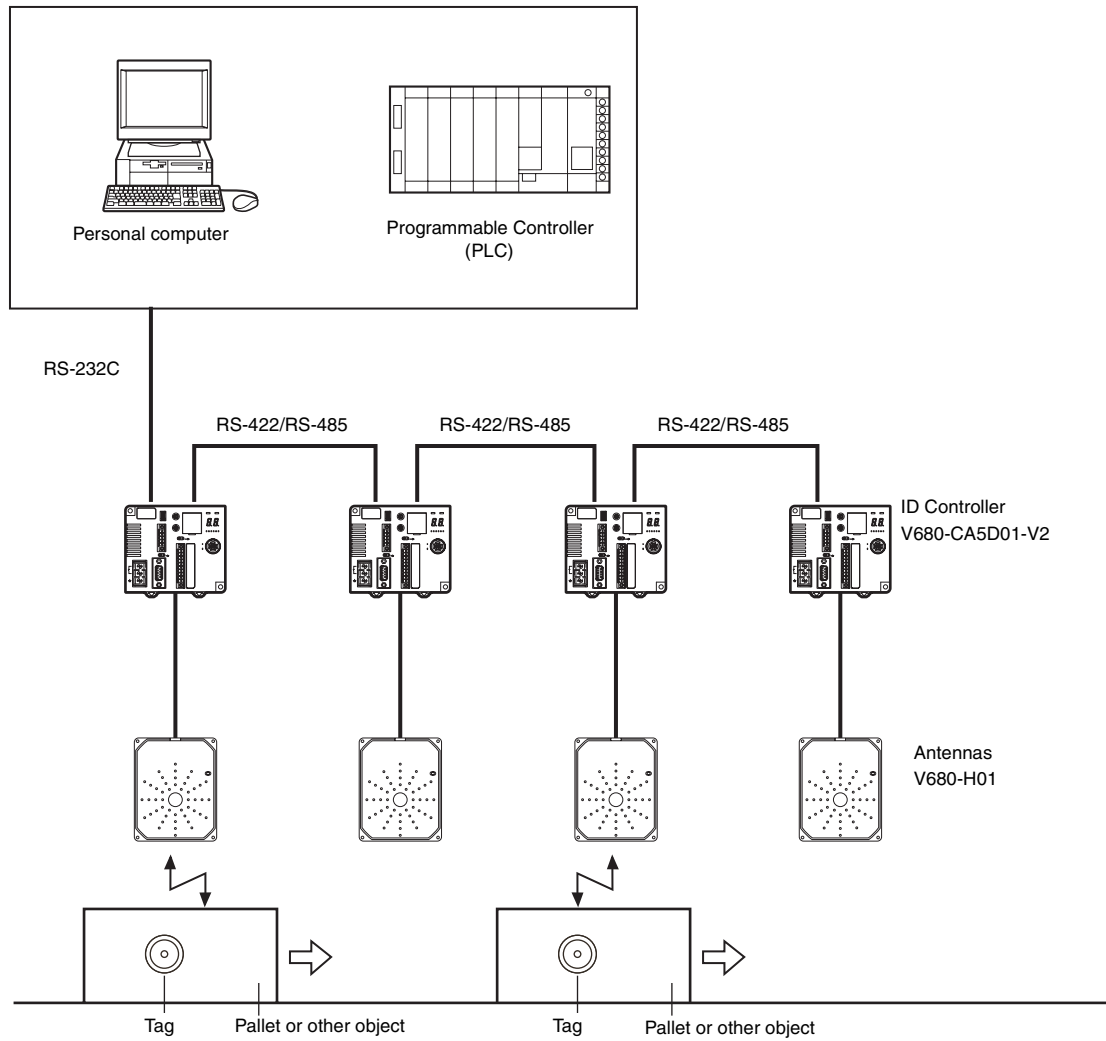

The V680-H01 Antenna can be connected only to the V680-CA5D01-V2 ID Controller. It cannot be used with the V680-CA5D02-V2 ID Controller



## 1:N Connections with RS-422/RS-485 Connection to Host Device

The host device and other ID Controllers can all be connected via RS-422 or RS-485 interfaces.

- Using an Antenna Other than the V680-H01

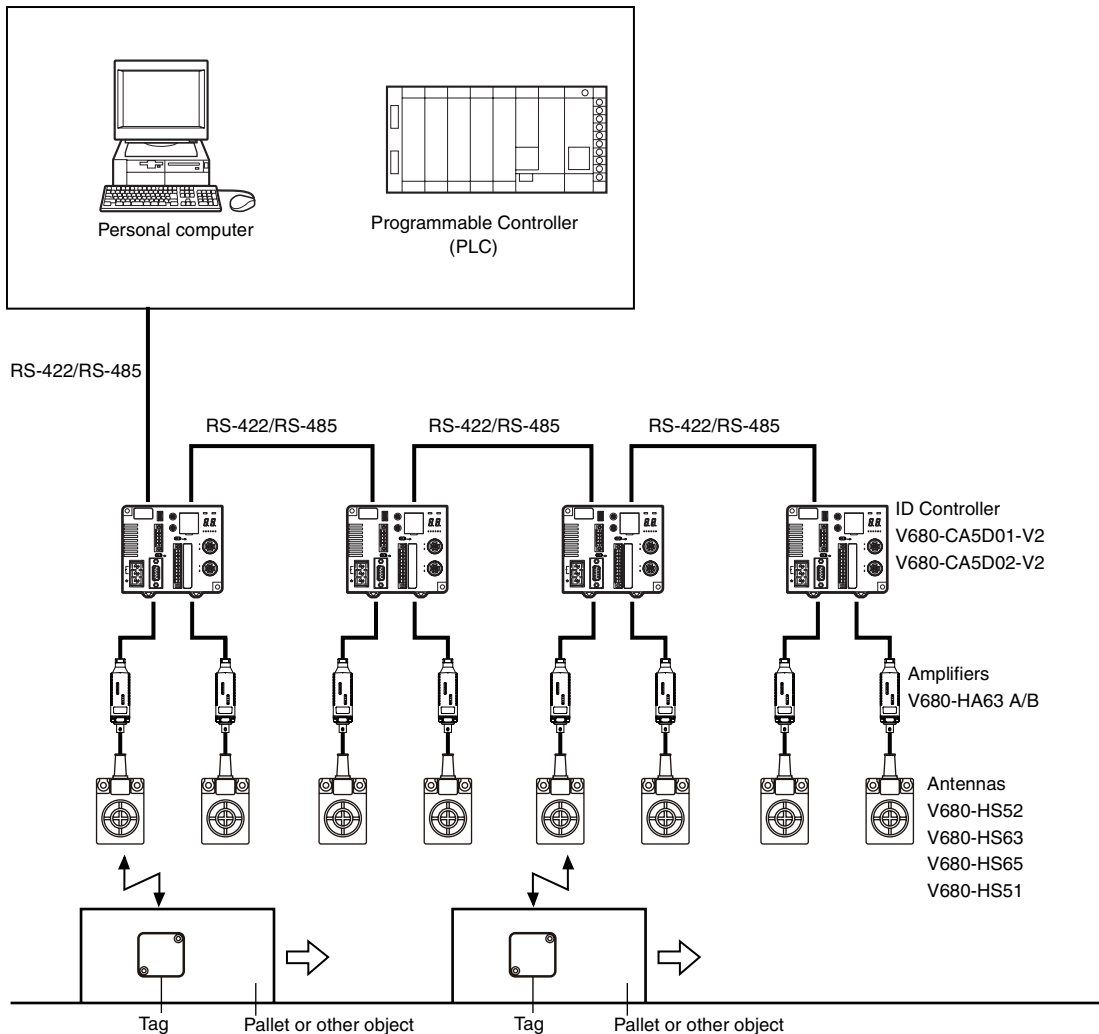

- Using a V680-H01 Antenna

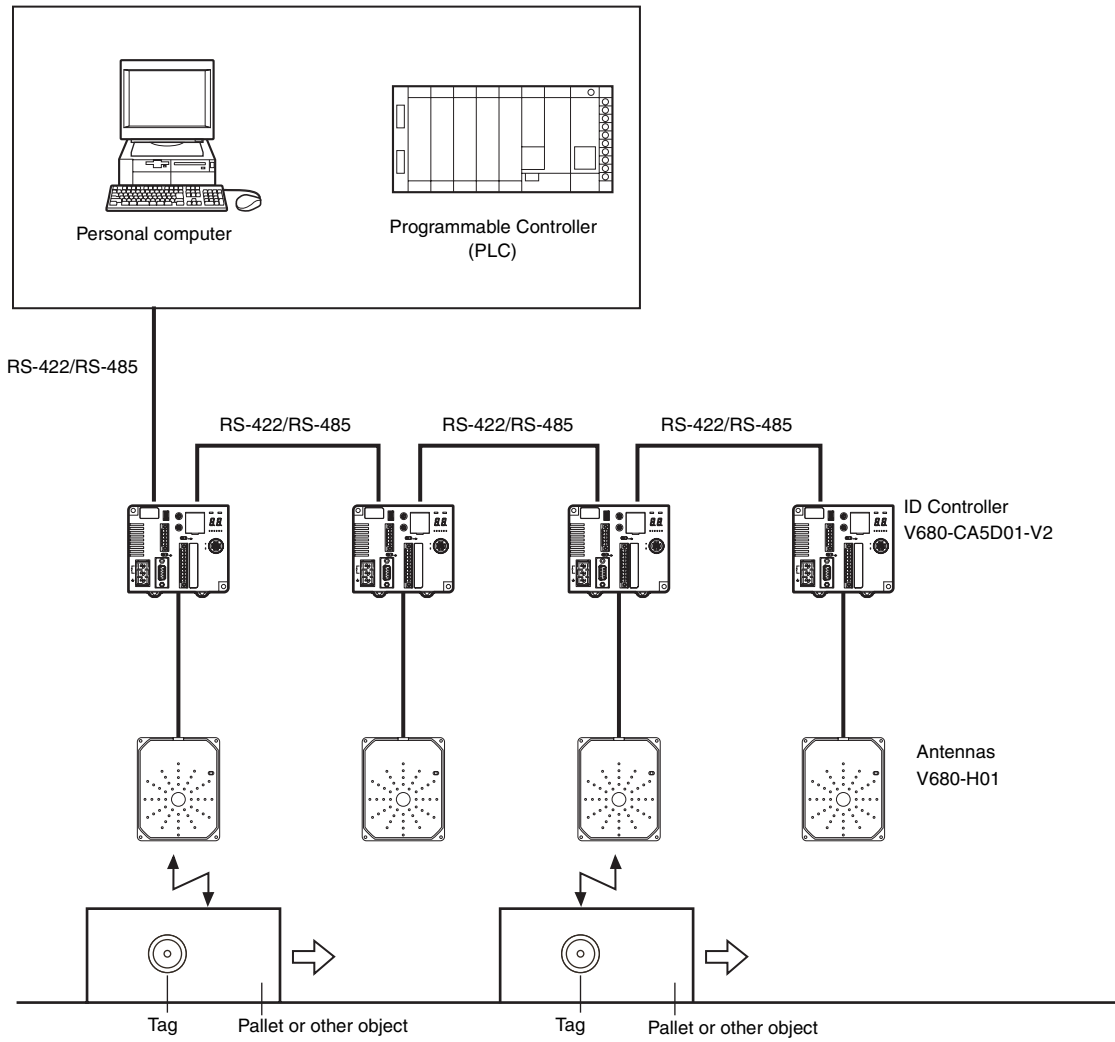

The V680-H01 Antenna can be connected only to the V680-CA5D01-V2 ID Controller. It cannot be used with the V680-CA5D02-V2 ID Controller

CHECK!

# Application Flowchart

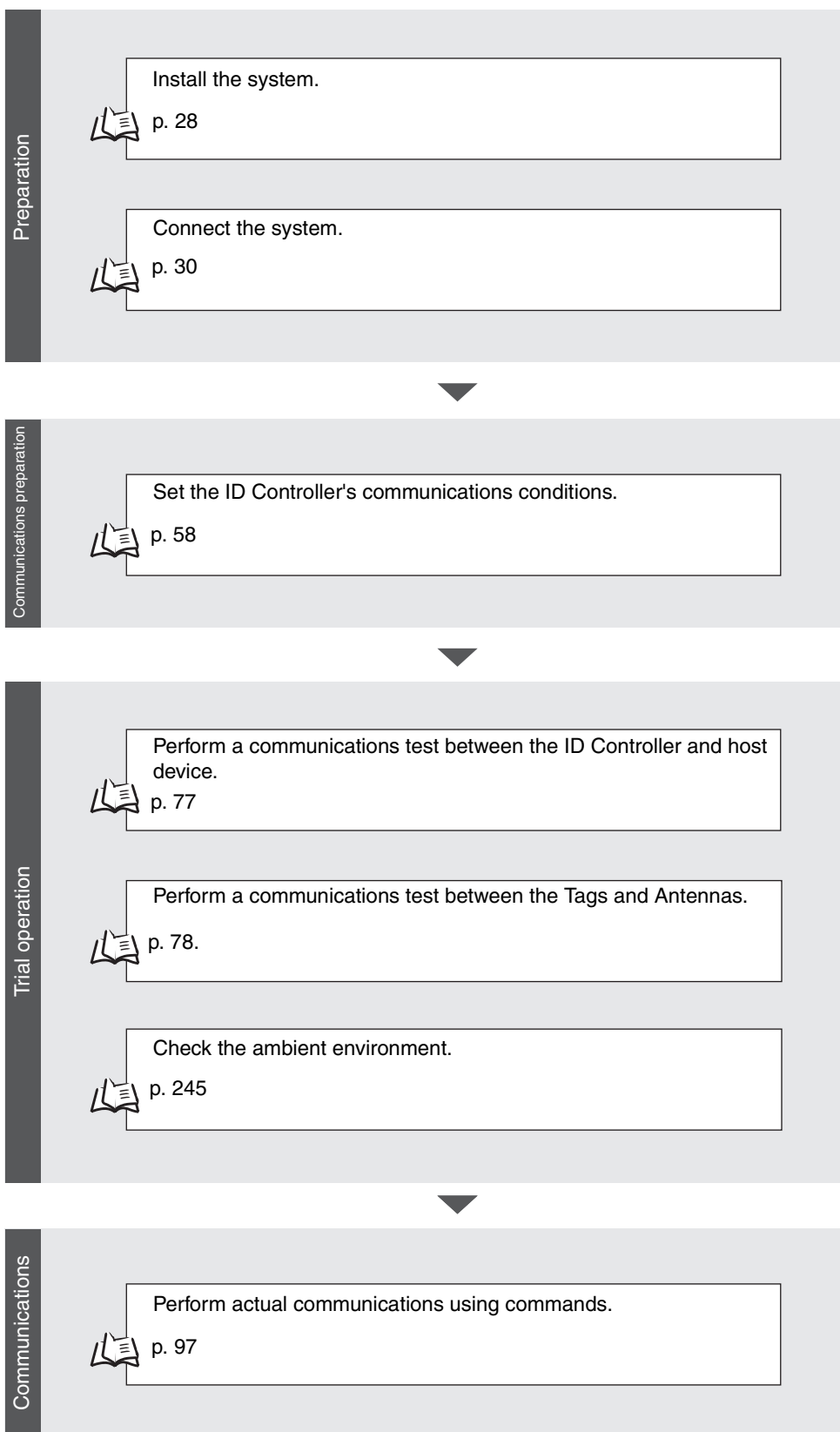

MEMO

# SECTION 2

## Installation, Connections, and Wiring

❏ Installation	28
❏ Connection and Wiring	30

# Installation

To increase the reliability of the V680-CA5D01-V2 / -CA5D02-V2 ID Controllers and ensure full functionality, install the ID Controller according to the instructions provided in this section.

## Installation Site

Do not install the ID Controller in the following locations.

- Locations exposed to ambient temperatures that are not between  $-10$  and  $55^{\circ}\text{C}$  or where there are radical temperature changes resulting in condensation
- Locations exposed to humidity that is not between 25% and 85%
- Locations subject to corrosive gas, flammable gas, dust, salt, or metal powder
- Locations that will expose the ID Controller to direct vibration or shock
- Locations exposed to direct sunlight
- Locations exposed to spray of water, oil, or chemicals
- Locations more than 2,000 m above sea level

## Mounting in a Panel

The ID Controller can be used at an ambient temperature range of  $-10$  to  $55^{\circ}\text{C}$ . Be sure to observe the following precautions.

- Make sure that the ID Controller is provided with sufficient ventilation space.
- Do not install the ID Controller close to heaters, transformers, or large-capacity resistors that radiate excessive heat.

## Installation Method

### ■ Mounting Directly in a Panel

Be sure to secure the ID Controller with two M4 screws together with spring washers and flat washers when enclosing the ID Controller in a panel.

Recommended tightening torque: 1.2 N·m

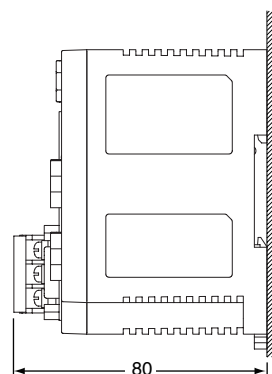
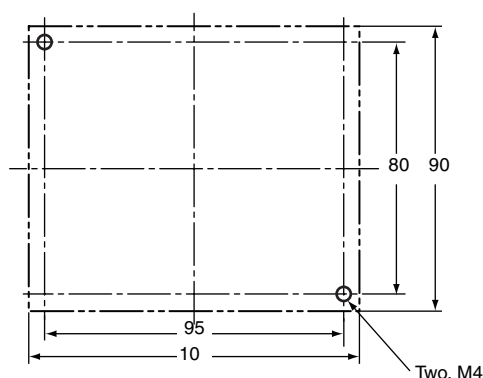

### ■ Mounting to a DIN Track

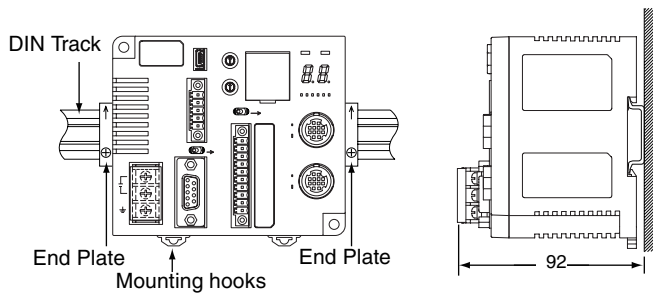

- 1) First hook the Controller to part A, and then press the Controller in direction B to mount the Controller to the DIN Track.
- 2) To disconnect the Controller from the DIN Track, pull the mounting hook downwards, and then lift the Controller upwards.

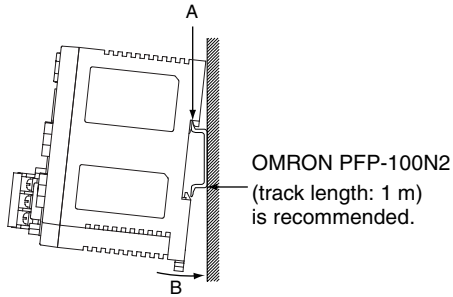

PFP-100N2  
DIN Track

PFP-M  
End Plate

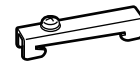
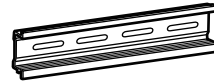

#### Attaching the End Plates

To mount an End Plate easily, first hook the bottom of the End Plate and then hook the top on the DIN Track, pull the End Plate downwards and tighten the screw.  
Recommended tightening torque: 1.2 N·m.

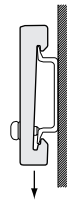
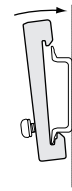

### ■ Mounting Interval

Leave a space of at least 10 mm between V680-CA5D01-V2/-CA5D02-V2 ID Controller. The ID Controllers will generate heat if they are mounted side-by-side.

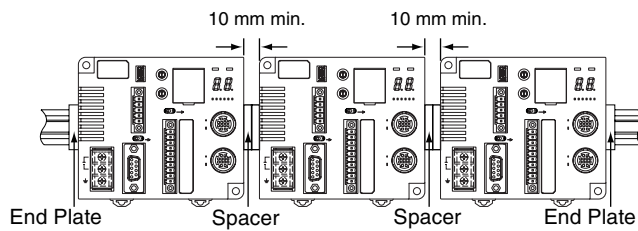

Use at least 2 OMRON DIN Track Spacers. (Each Spacer is 5 mm wide.)

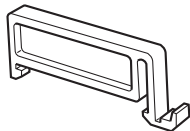

PFP-S  
Spacer

# Connection and Wiring

## Power Supply and Ground Wires

The power supply and ground terminals use M3 self-rising screws. The following type of crimp terminals can be connected to these terminals.

Recommended tightening torque: 0.5 N·m

Examples of Applicable Crimp Terminals

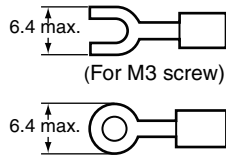

Manufacturer	Model	Applicable wire	Type
J.S.T. Mfg. Co., Ltd.	1.25-N3A	0.25 to 1.65 mm <sup>2</sup> AWG22 to AWG16	Forked
	V1.25-N3A		
	1.25-MS3		Round
	V1.25-MS3		

- Provide 24 VDC to the Controller. The allowable fluctuation in the power supply is 24 VDC (−15%/+10%).
- ID Controllers have built-in noise countermeasures against noise superimposed on the power supply line. Ground noise can be reduced further by attaching a filter to the power supply line.
- Twisted-pair wire is recommended for the power line.
- To increase resistance to noise, ground to 100 Ω or less to an independent ground pole.
- Use a class 2 power supply.

● Recommended Compact DC Power Supply (OMRON)

Model	Output capacity	Input voltage
S8VS-03024	24 VDC, 1.3 A	100 to 240 VAC

**Note:** The maximum power consumption of the Controller is 30 W (1.3 A at 24 VDC). The inrush current, however, must be considered when selecting the power supply capacity. A power supply with an output of 1.3 A min. at 24 VDC is recommended.

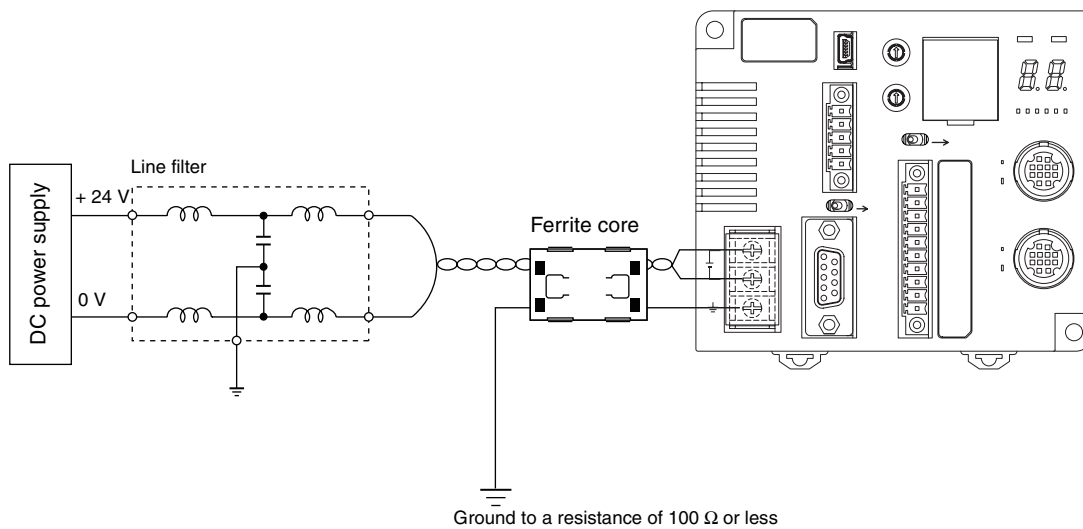



- To reduce the influence of radiated noise, use a ferrite core.  
Use the following procedure.

**1.** Wire the power supply and ground lines as normal.

**2.** Wrap the power supply lines and ground line together around the ferrite core. Loop them around the ferrite core once so that the ferrite core does not move. The ferrite core should be within 10 cm of the ID Controller.

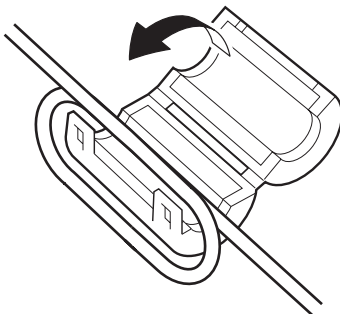

**3.** Close the ferrite core until you hear it click into place.

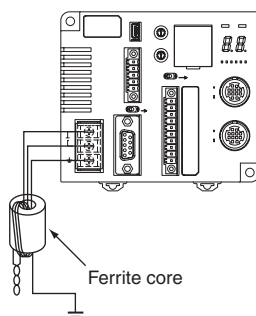

## Wiring I/O Lines

### ■ Precautions for Reset Signal Input

- Be sure that the input voltage does not exceed the maximum applicable voltage (26.4 V). The device may malfunction if the rated voltage is exceeded.
- To improve noise resistance, install the input line 1 m or more away from high-voltage devices and power lines.

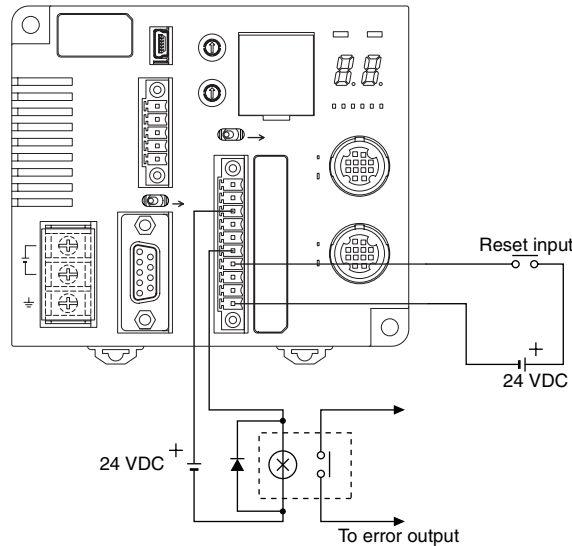

### ■ Precautions for Error Signal Output

- The maximum switching capacity for the output is 100 mA at 24 VDC (–15% to +10%). Do not use voltages or loads that exceed the switching capacity. Doing so may cause malfunctions.
- Use an auxiliary relay (24 VDC, 100 mA max.) to connect the output circuit.

### ■ Pin Arrangement

Pin No.	Name	
	V600 I/O	V680 I/O
1	RUN	
2	BUSY	OUT3
3	ERROR	OUT4
4	OUT1	
5	OUT2	
6	COM_O	
7	RST	
8	TRG1	
9	TRG2	
10	COM_I	

#### • Controller Terminal Arrangement

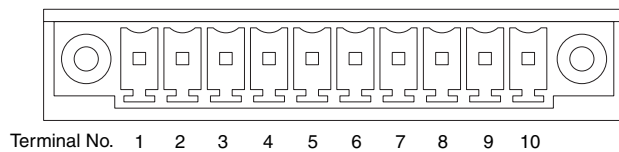

Refer to *External I/O Port* for details on the external I/O port.



p. 14

## ■ Mounting Cables

Use the connectors provided with the ID Controller.

		Manufacturer	Model	Remarks
Cable	I/O lines	---	---	0.5 mm <sup>2</sup> (equivalent to AWG 20)
Connector		Phoenix Contact	MC1.5/10-STF-3.5	---
Crimp terminals	When connecting 1 line to each terminal		AI0.5-8WH	---
	When connecting 2 lines to each terminal		AI-TWIN2 × 0.5-8WH	---
Crimping Tool			CRIMPFOX UD6	---

1. Attach the crimp terminals to the sections of the cable where the sheath has been stripped.
2. Make sure the connector is facing the right direction and insert each crimp terminal into the correct connector hole.

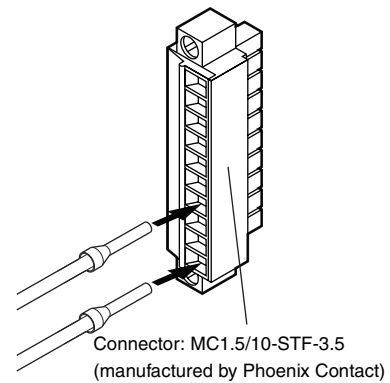

3. Firmly tighten the connector cable screws.  
Recommended tightening torque: 0.22 N·m



Use a small flat-blade screwdriver with a uniform thickness. Do not use a standard screwdriver with a tapered end. A standard screwdriver will not fully insert into the hole.

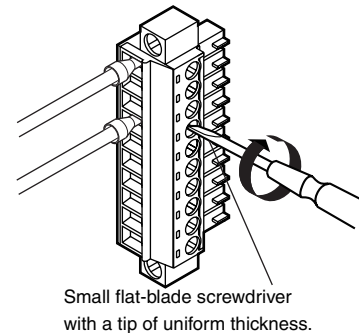

4. Once all of the cables have been connected to the connector, attach the connector to the ID Controller.

Align the cable connector with the connector on the ID Controller. Hold the connector body and push the connector firmly into place, and then tighten the connector lock screws.

Recommended tightening torque: 0.4 N·m

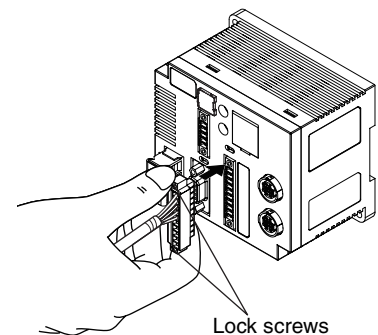

Removing the Connector

Completely loosen the two lock screws, hold the protruding part of the connector, and pull straight out. If the connector is difficult to remove, press on the ID Controller while pulling on the connector.



Do not connect cables to the connector after attaching the connector to the ID Controller.

## RS-232C Port

### Pin Arrangement

Pin No.	Symbol	Signal direction		Signal name
		Input	Output	
9	SG	---	---	Signal ground or common return line
2	SD	---	○	Send data
3	RD	○	---	Receive data
4	RS	---	○	Request to send
5	CS	○	---	Clear to send

### Controller Terminal Arrangement

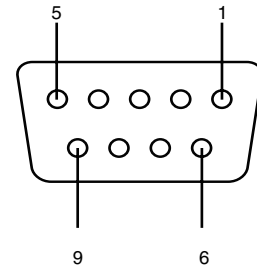

CHECK!

The pin arrangement is different from that of the V680-CA1A. Use an RS-232C cable for the V680-CA5D□□-V2.

### Connections to Host Device

#### Example Connection to OMRON PLC

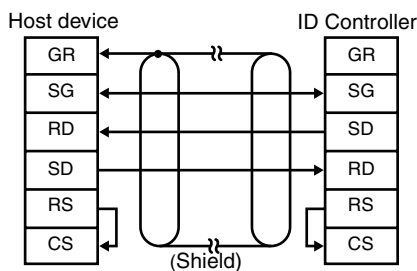

#### Recommended Cable

Model	Manufacturer
XW2Z-□□□T	OMRON

- Note 1.** Ground the shield at the host device side to prevent operation errors.
- Short-circuit pins 4 (RS) and 5 (CS) inside the connector.

#### Example Connection to IBM PC/AT or Compatible Computer via D-SUB 9-pin Connector

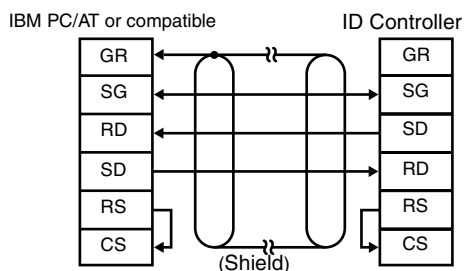

#### Recommended Cable

Model	Manufacturer
XW2Z-□□□S-V	OMRON

- Note 1.** The interface cable will have a male connector on the ID Controller and a female connector on the IBM PC/AT or compatible.
- Ground the shield at the host device to prevent operation errors.



CHECK!

Refer to *Connections between ID Controllers (1:N)* for information on 1:N connections.

p. 39

▪ Connecting to Ethernet

The ID Controller can be connected to the host device through an OMRON ITNC-SGB01 Serial Gate Box to enable Ethernet TCP/IP communications. An ID Controller connected through a Serial Gate Box can be communicated with in exactly the same way as when the ID Controller is connected through the serial interface.

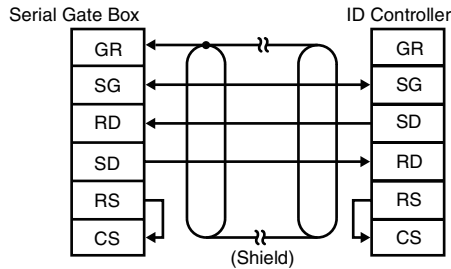

Model	Rated power supply voltage	Power consumption
ITNC-SGB01	DC24V +10% -15%	3 W max.



Refer to the ITNC-SGB01 Serial Gate Box manual for details on the Serial Gate Box.

1:1 Connection

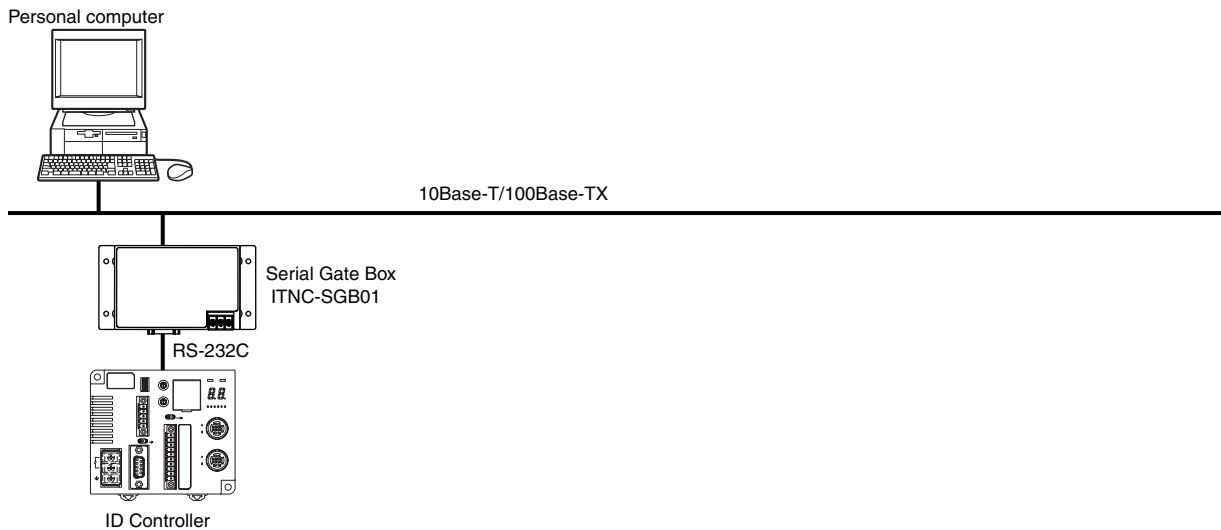

1:N Connections

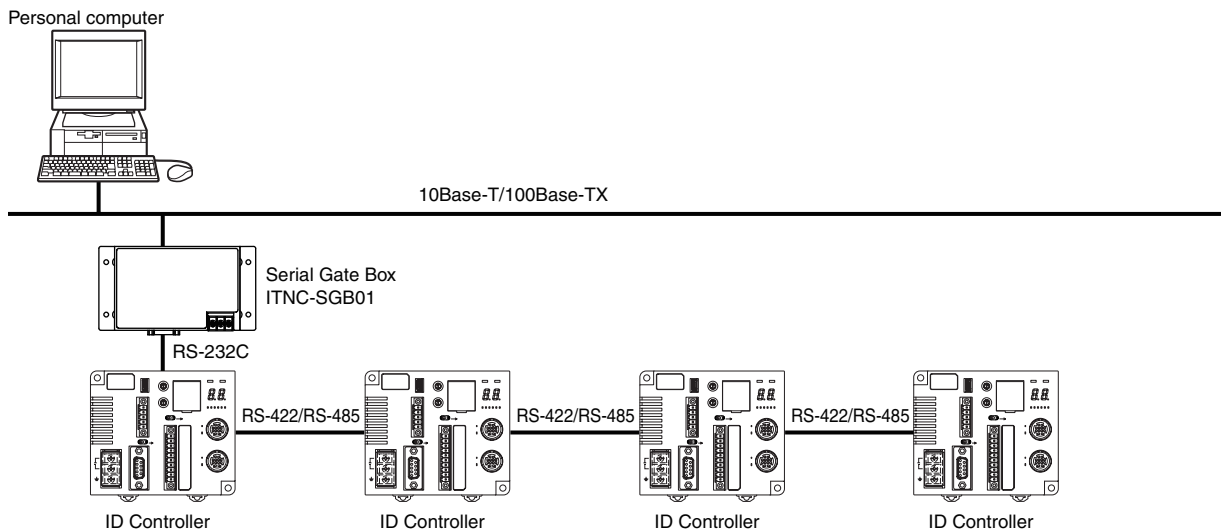

■ **Assembling and Connecting the Communications Connector**

Have a connection cable and connector ready.

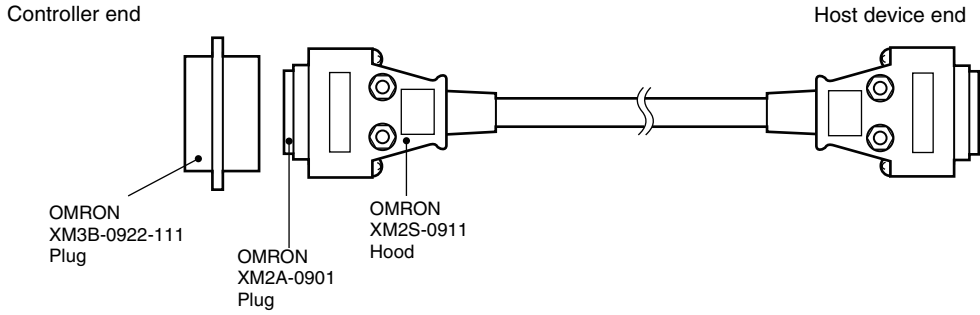

■ **Assembling the Connector**

**1.** Prepare the end of the cable as shown below.

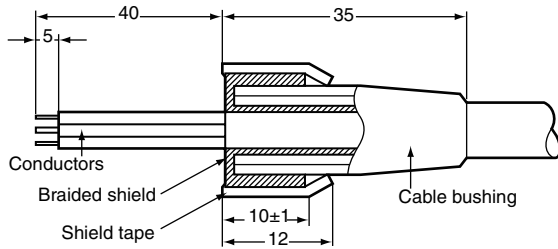

- Insert the cable into the cable bushing.
- Unravel the braided shield for approximately 10 mm and fold it back on the cable bushing.
- Apply shield tape to the folded braided shield.

**2.** Solder the conductors to the plug pins.

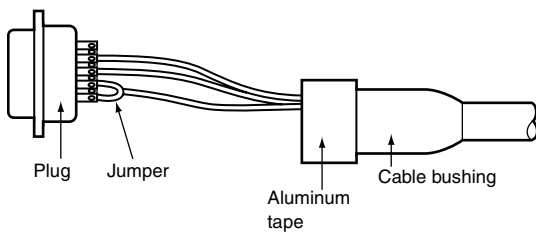

Pin No.	Symbol	Signal name
9	SG	Signal ground
2	SD	Send data
3	RD	Receive data
4 (See note.)	RS	Request to send
5 (See note.)	CS	Clear to send

**Note:** Short-circuit pins 4 (RS) and 5 (CS) with a jumper.

**3.** Attach housing A2 of the Hood to the Plug and secure the aluminum-taped portion with the cable clamp.

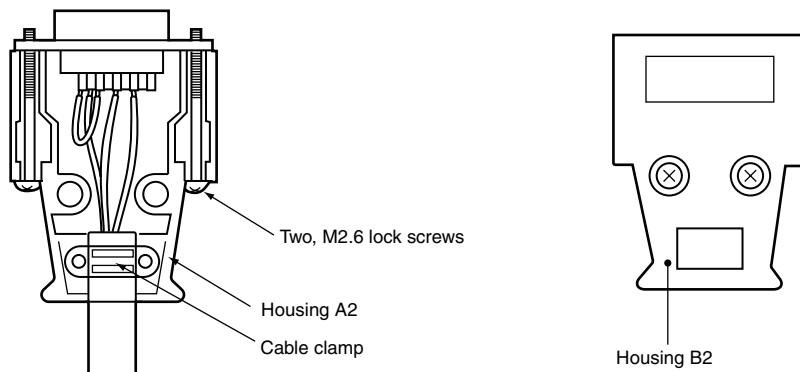

**4.** Secure the two connector lock screws and put on housing B2 to complete the connector.

## ■ Connecting and Disconnecting the Connector

- When connecting the connector, be sure to hold the connector by hand and fully insert the connector. Secure the connector by tightening the two lock screws with a Phillips screwdriver. Recommended tightening torque: 0.3 N·m
- When disconnecting the connector, completely loosen the two lock screws. Hold the protruding part of the connector hood by hand and pull the connector straight out. If the connector is difficult to disconnect, hold the ID Controller with your hand while pulling on the connector.

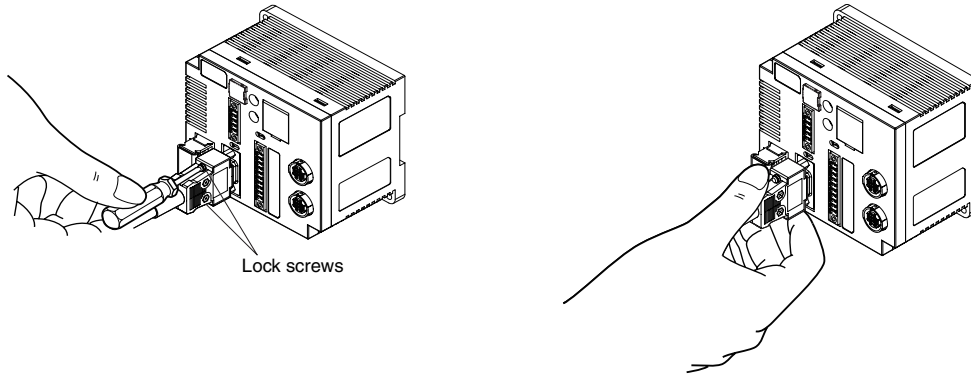

## RS-422/RS-485 Port

### Pin Arrangement

Pin No.	Name	Details
1	RDA(-)	Receive data
2	RDB(+)	Receive data
3	SDA(-)	Send data
4	SDB(+)	Send data
5	SG	SG

**Note:** The port can be used as an RS-485 port if terminals 1 and 3, and 2 and 4 are short-circuited.

### Controller Terminal Arrangement

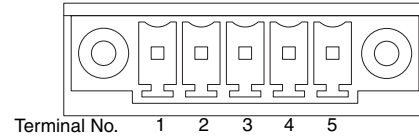

### Connections to Host Device

#### RS-422 Connections

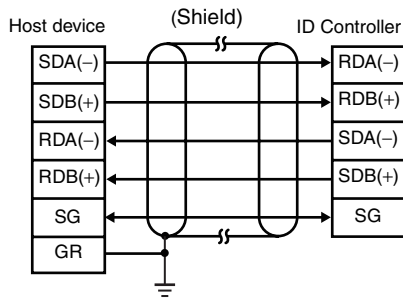

**Note:** Ground the shield at the host device to prevent operation errors.

#### RS-485 Connections

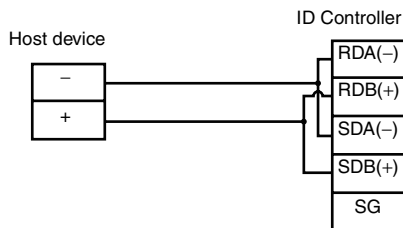

**Note:** Short-circuit terminals 1 and 3, and 2 and 4. Do not connect anything to the ID Controller signal ground.

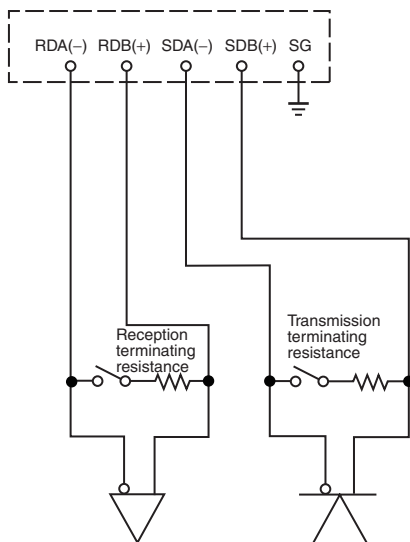

**Terminating resistance: 220 ( $\Omega$ ) for RS-422, 110 ( $\Omega$ ) for RS-485**

**Note:** Turn ON terminating resistance only at the ID Controllers at the both ends of the trunk cable. Turn OFF the terminating resistance at all ID Controllers in between. Normal transmissions will not be possible if terminating resistance is turned ON for the ID Controllers in between.



■ Connections between ID Controllers (1:N)

▪ RS-232C Connection to the Host Device

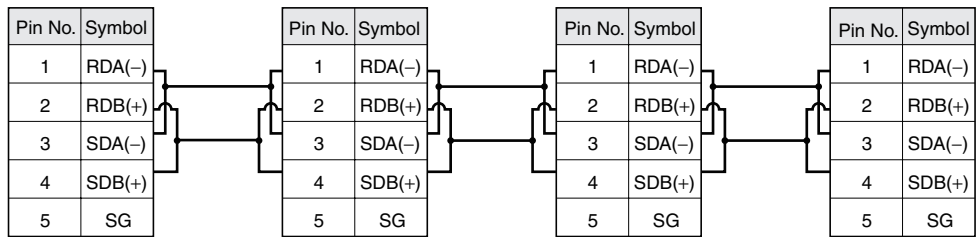
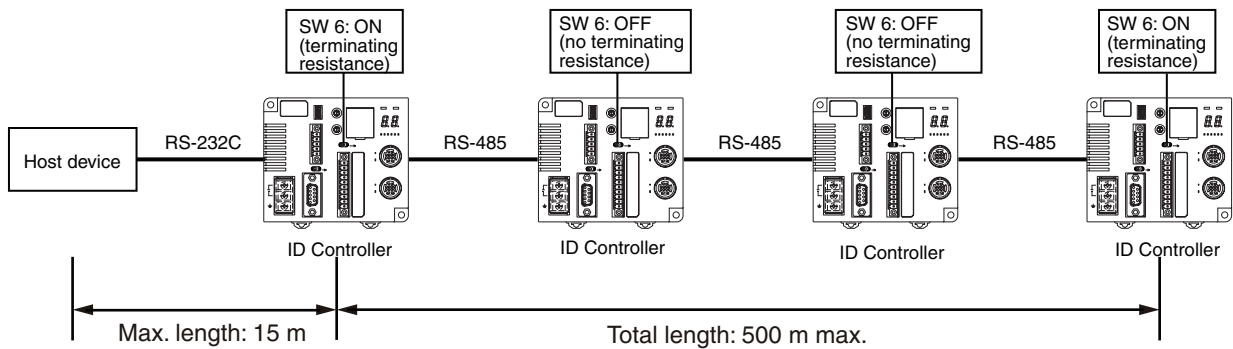
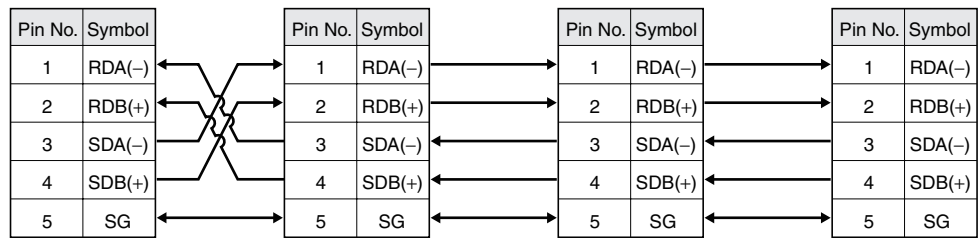
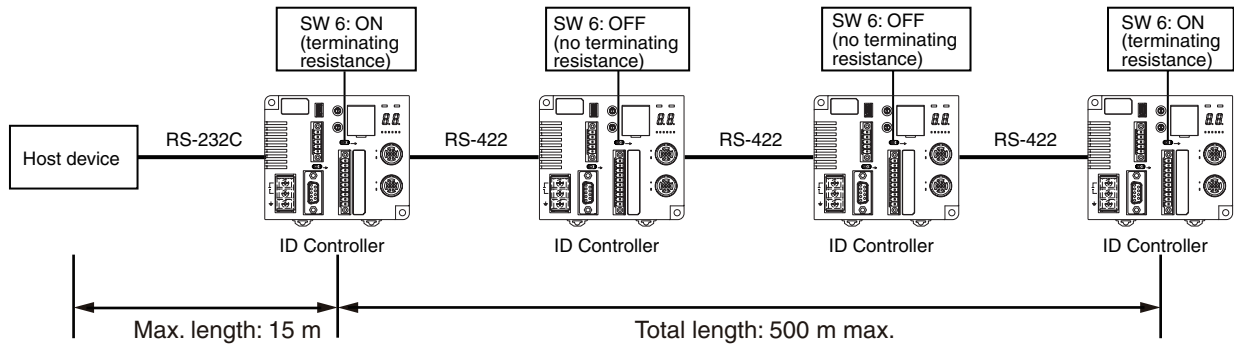

**Note:** Short-circuit terminals 1 and 3, and 2 and 4 to use RS-485 communication.



Refer to *Connections to Host Device* for information on RS-232C connections between the host device and ID Controllers.

p. 34



If the first communications received by an ID Controller are via the RS-232C interface, reception of RS-422/RS-485 communications will be prohibited. If the first communications are received via RS-422/RS-485, reception of RS-232C communications will be prohibited. Therefore, when changing the system configuration of an ID Controller, always turn OFF the power supply before changing the connections.

▪ **RS-422 Connection to Host Device**

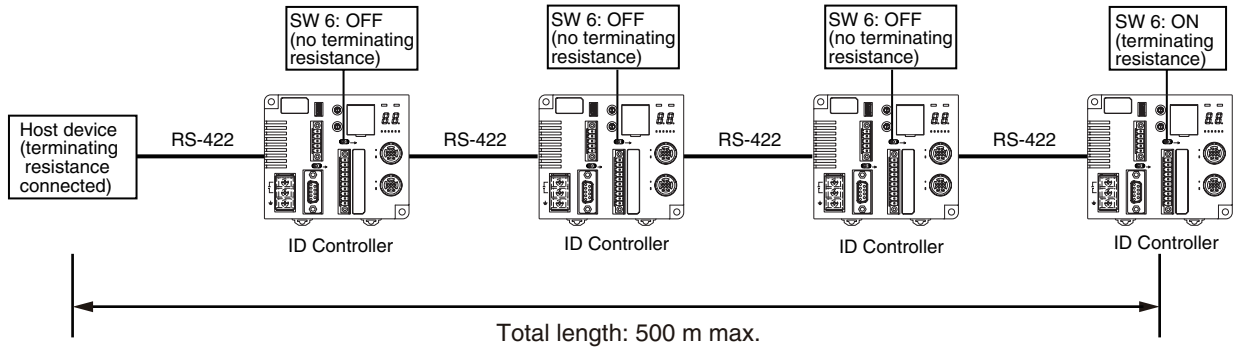

Pin No.	Symbol	Pin No.	Symbol	Pin No.	Symbol	Pin No.	Symbol
1	RDA(-)	1	RDA(-)	1	RDA(-)	1	RDA(-)
2	RDB(+)	2	RDB(+)	2	RDB(+)	2	RDB(+)
3	SDA(-)	3	SDA(-)	3	SDA(-)	3	SDA(-)
4	SDB(+)	4	SDB(+)	4	SDB(+)	4	SDB(+)
5	SG	5	SG	5	SG	5	SG



Refer to *RS-422 Connections* for information on RS-422 connections between the host device and ID Controllers.

p. 38



If the first communications received by an ID Controller are via the RS-232C interface, reception of RS-422/RS-485 communications will be prohibited. If the first communications are received via RS-422/RS-485, reception of RS-232C communications will be prohibited. Therefore, when changing the system configuration of an ID Controller, always turn OFF the power supply before changing the connections.

▪ **RS-485 Connection to the Host Device**

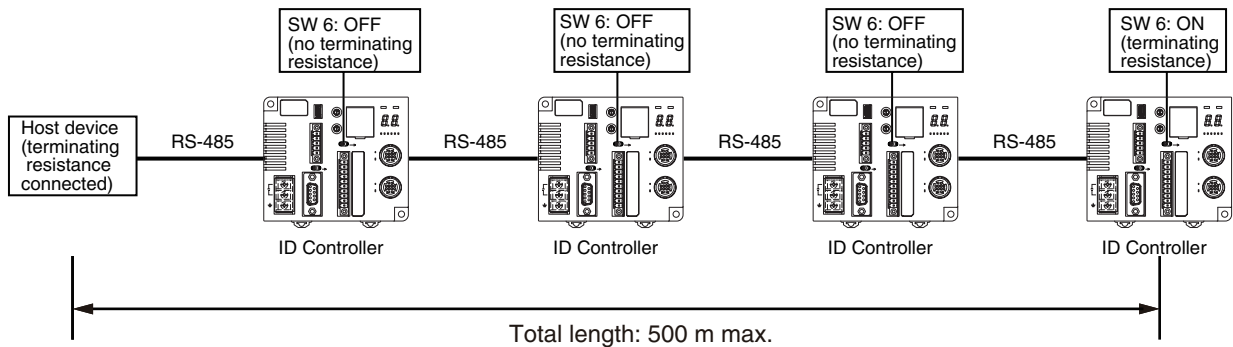

Pin No.	Symbol	Pin No.	Symbol	Pin No.	Symbol	Pin No.	Symbol
1	RDA(-)	1	RDA(-)	1	RDA(-)	1	RDA(-)
2	RDB(+)	2	RDB(+)	2	RDB(+)	2	RDB(+)
3	SDA(-)	3	SDA(-)	3	SDA(-)	3	SDA(-)
4	SDB(+)	4	SDB(+)	4	SDB(+)	4	SDB(+)
5	SG	5	SG	5	SG	5	SG

**Note:** Short-circuit terminals 1 and 3, and 2 and 4 to use RS-485 communications.



Refer to *RS-485 Connections* for information on RS-485 connections between the host device and ID Controllers.

p. 38



If the first communications received by an ID Controller are via the RS-232C interface, reception of RS-422/RS-485 communications will be prohibited. If the first communications are received via RS-422/RS-485, reception of RS-232C communications will be prohibited. Therefore, when changing the system configuration of an ID Controller, always turn OFF the power supply before changing the connections.

## ■ Mounting Cables

Use the connectors provided with the ID Controller.

		Manufacturer	Model	Remarks
Cable	RS-422 lines	---	---	0.5 mm <sup>2</sup> (equivalent to AWG 20)
Connector		Phoenix Contact	MC1.5/5-STF-3.5	---
Crimp terminals	When connecting 1 line to each terminal		AI0.5-8WH	---
	When connecting 2 lines to each terminal		AI-TWIN2 × 0.5-8WH	---
Crimping Tool			CRIMPFOX UD6	---

**1.** Attach the crimp terminals to the sections of the cable where the sheath has been stripped.

**2.** Make sure the connector is facing the right direction and insert each crimp terminal into the correct connector hole.

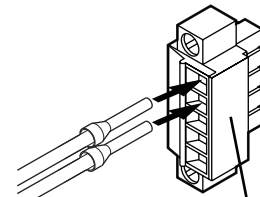

Connector: MC1.5/5-STF-3.5  
(manufactured by Phoenix Connector)

**3.** Firmly tighten the connector cable screws.

Recommended tightening torque: 0.22 N·m



Use a small flat-blade screwdriver with a uniform thickness. Do not use a standard screwdriver with a tapered end. A standard screwdriver will not fully insert into the hole.

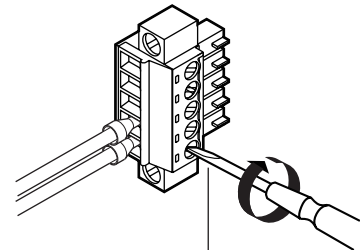

Small flat-blade screwdriver with a tip of uniform thickness.

**4.** Once all of the cables have been connected to the connector, attach the connector to the ID Controller.

Align the cable connector with the connector on the ID Controller. Hold the connector body and push the connector firmly into place, and then tighten the connector lock screws.

Recommended tightening torque: 0.4 N·m

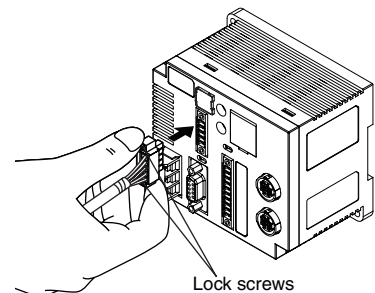

Lock screws



Removing the Connector

Completely loosen the two lock screws, hold the protruding part of the connector, and pull straight out. If the connector is difficult to remove, press on the ID Controller while pulling on the connector.



Do not connect cables to the connector after attaching the connector to the ID Controller.

## USB Port

The USB port is connected to a USB cable (Series A-Mini USB series B connectors).



The USB port is not a control port. Always use the RS-232C port or RS-422/RS-485 port for system configuration.  
p. 19

CHECK!

### Pin Arrangement

Pin No.	Name	Description
1	VBUS	Power supply
2	D-	USB data (-)
3	D+	USB data (+)
5	GND	Ground

### Controller Terminal Arrangement

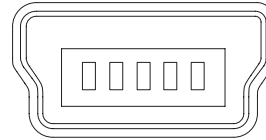

Terminal No. 1 2 3 4 5

Pin No.	Symbol		Pin No.	Symbol
1	VBUS	→	1	VBUS
2	D-	←	2	D-
3	D+	←	3	D+
4	GND	←	5	GND
-	GR	←	-	GR

### Connecting and Disconnecting Connectors

1. Connect the Mini USB series B end of the connector to the ID Controller.

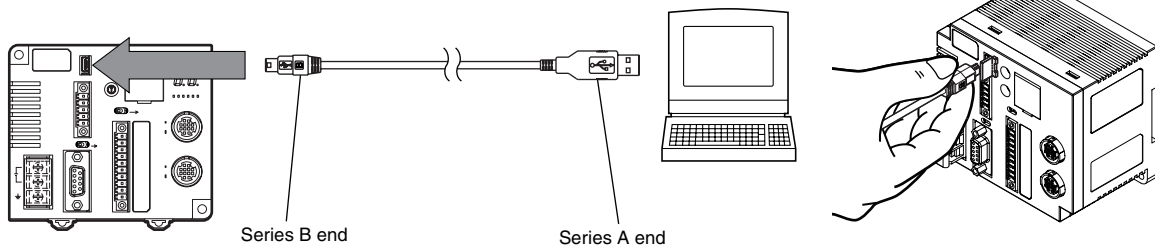

A cap is attached to the connectors at shipment. Leave this cap on if USB is not being used to prevent dust or foreign matter from entering the connectors and to prevent static electricity.

CHECK!



#### Removing Connectors

Hold the base of the connector and pull straight out. If the connector is difficult to remove, press the ID Controller while pulling on the connector.

CHECK!

2. Connect the Series A end of the connector to the host device.  
Align the connectors and insert the connector straight in.

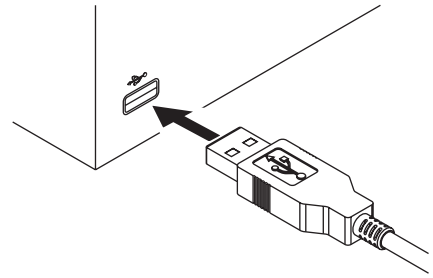

3. Removing the Connector from the Host Device  
Close the software on the host device and pull the connector straight out.



CHECK!

If the connector is removed while the software is running on the host device, the software will not operate properly, which will cause a fatal error.

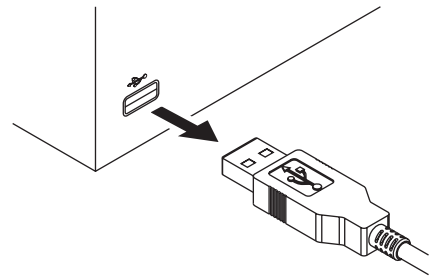

### ■ Installing Ferrite Cores

Noise resistance may be low because USB is being used.

Noise resistance can be improved by using the ferrite core listed below.

Manufacturer	Model
SEIWA	E04SR301334

1. Install the ferrite core listed above to the cable.

Attach the ferrite core to the Mini USB Series B end. Close the ferrite core until it snaps shut. The ferrite core should be 10 cm or less from the connector.

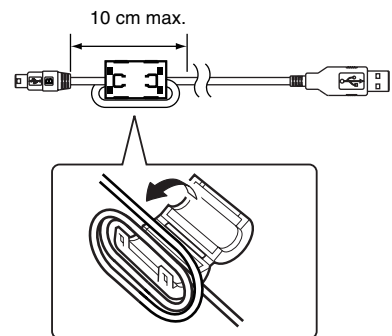

### ■ Installing the USB Driver

When connecting the ID Controller to the host device for the first time, the USB driver must be installed on the computer.

#### ■ Downloading the USB Driver

Download the USB driver for the V680-CA5D01-V2 or V680-CA5D02-V2.

For details, ask your OMRON representative for information on the USB driver.

#### ■ Installing the USB Driver on the Computers

The USB Driver can be used on Windows 2000 or XP. Install the driver on the host device following the procedure corresponding to the operating system being used.

Operation may not be possible on other operating systems.

## Windows 2000

1. Turn ON the power to the computer and start Windows 2000.

2. Connect the ID Controller to the computer via USB.



Refer to *USB Port* for information on the connection method.

CHECK!  p. 42

The following dialog box will be displayed when the ID Controller is connected via USB.



3. Once the following dialog box has been displayed, click the **Next** Button.



4. Select *Search for a suitable driver for my device (recommended)* and click the **Next** Button.

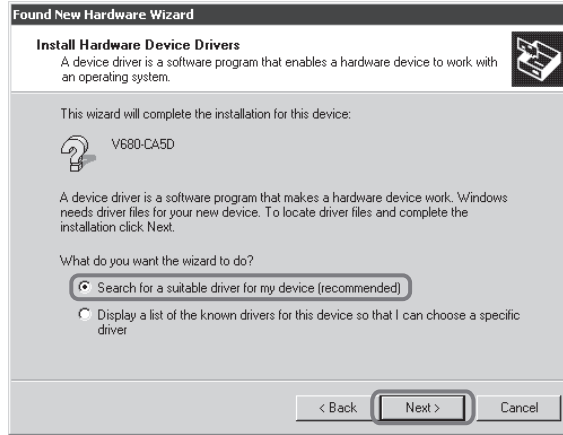

5. Select *Specify a location* and click the **Next** Button.

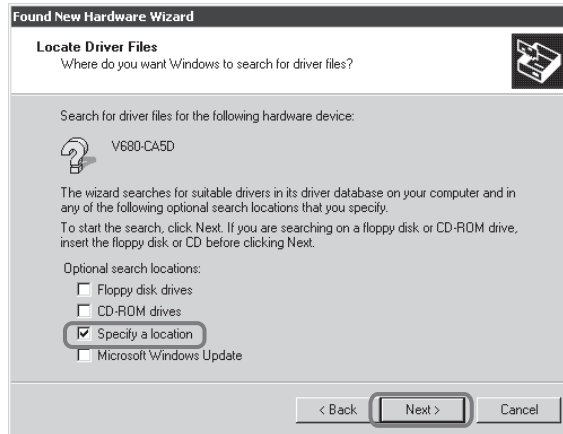

6. Click the **Browse** Button and select the folder where the downloaded V680-CA5D\_100.inf is to be saved.



**7.** Click the **Next** Button.

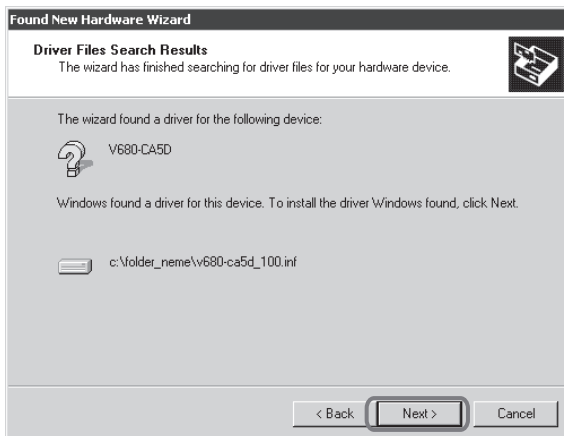

The following dialog box will be displayed when the software installation has been completed.



**8.** Click the **Finish** Button.



▪ Checking Installation

Use the following procedure to confirm that the driver has been correctly installed.

1. Connect the ID Controller to the computer via USB.

2. Select **Settings - Control Panel - System** from the Windows Start Menu.

3. Click the **Device Manager** Button on the Hardware Tab Page.

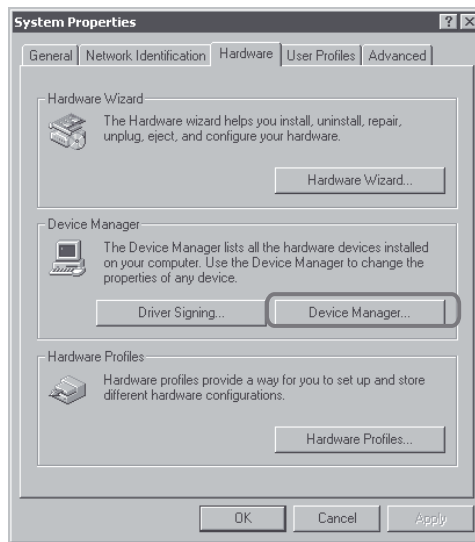

4. Select Ports (COM & LPT) and check that OMRON RFID USB COM is displayed.

If the driver is correctly installed the property window for the V680-CA5D□□-V2 will be as follows:

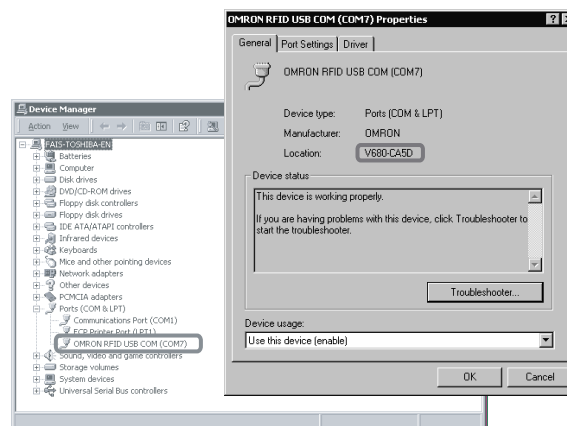

Communications with the ID Controller can be performed with the COM number displayed in parentheses after OMRON RFID USB COM.

## Windows XP

1. Turn ON the power to the computer and start Windows XP.

2. Connect the ID Controller to the computer via USB.

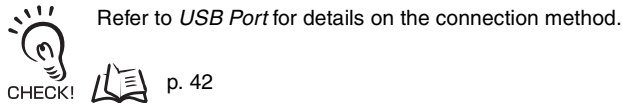

Wait for the following dialog box to be displayed.

3. When the following dialog box is displayed, select **Install from a list or specific location (Advanced)** and click the **Next** Button.

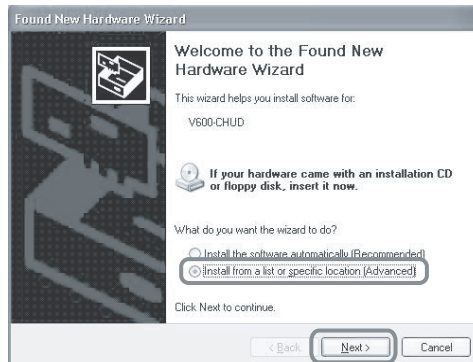

4. Click the **Browse** Button and select the folder in which the downloaded V680-CA5D\_100.inf file is to be saved. Then click the **Next** Button.

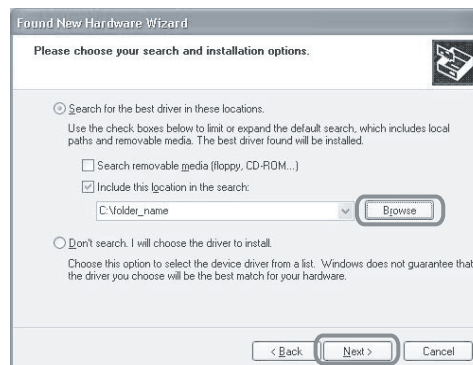

5. Click the **Continue** Button.



When the following dialog is displayed, installation is completed.

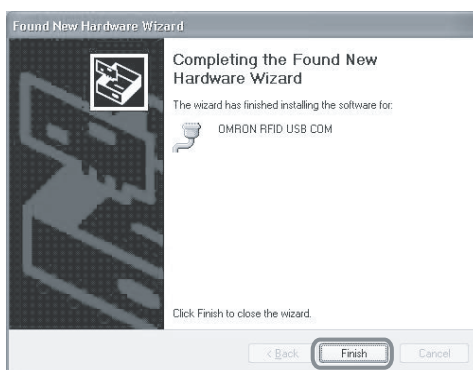

6. Click the **Finish** Button.

▪ Checking Installation

Use the following procedure to confirm that the driver has been correctly installed.

1. Connect the ID Controller to the computer via USB.

2. Select *Control Panel - Performance and Maintenance* from the Windows Start Menu.

3. Click the **System** Icon.

4. Click the **Device Manager** Button on the Hardware Tab Page.

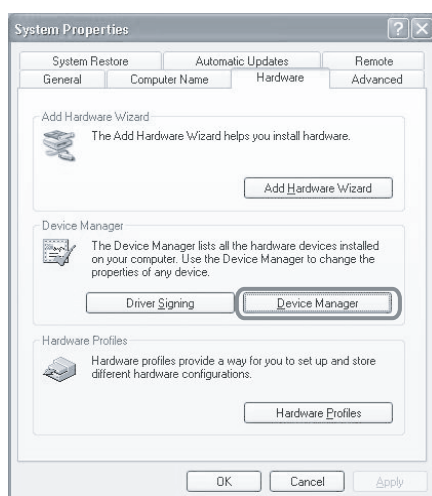

5. Select Ports (COM & LPT) and check that OMRON RFID USB COM is displayed.

If the driver is correctly installed the property window for the V680-CA5D□□-V2 will be as follows:

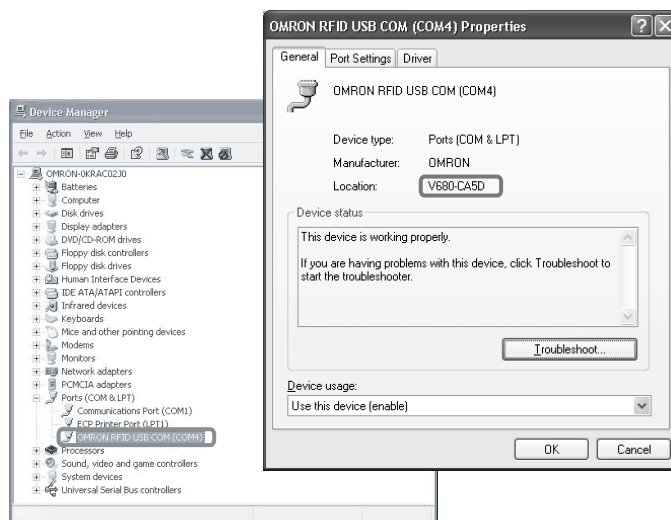

Communications with the ID Controller can be performed with the COM number displayed in parentheses after OMRON RFID USB COM.

## Windows Vista

1. Turn ON the power to the personal computer and start Windows Vista.

2. Connect the ID Controller to the computer via USB.



CHECK!



p. 42

For details on connection methods, refer to *USB Port*.

Wait for the following window to be displayed.

3. When the following window is displayed, select **Locate and install driver software (recommended)** Button.

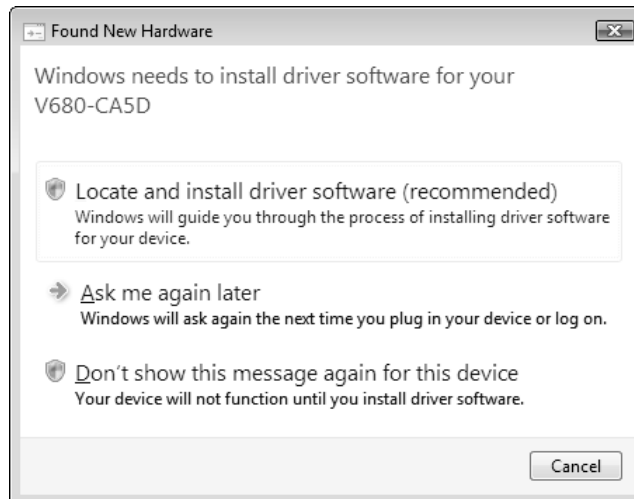

4. When the following window is displayed, select ***I don't have the disc. Show me other options.*** Button.

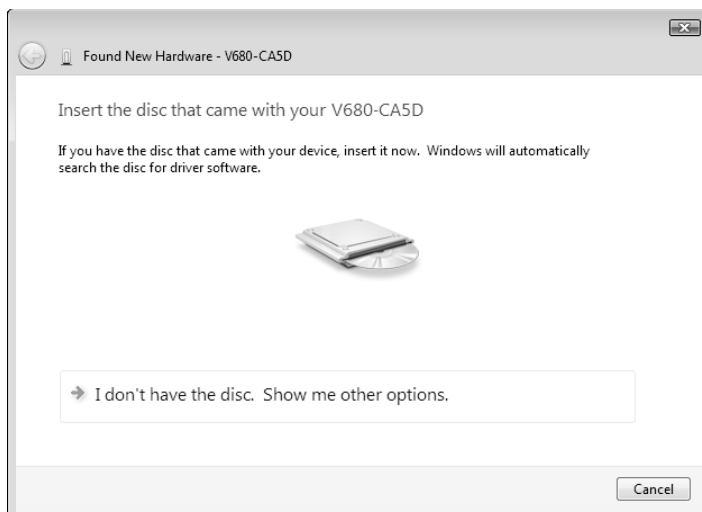

5. When the following window is displayed, select ***Browse my computer for driver software (advanced)*** Button.

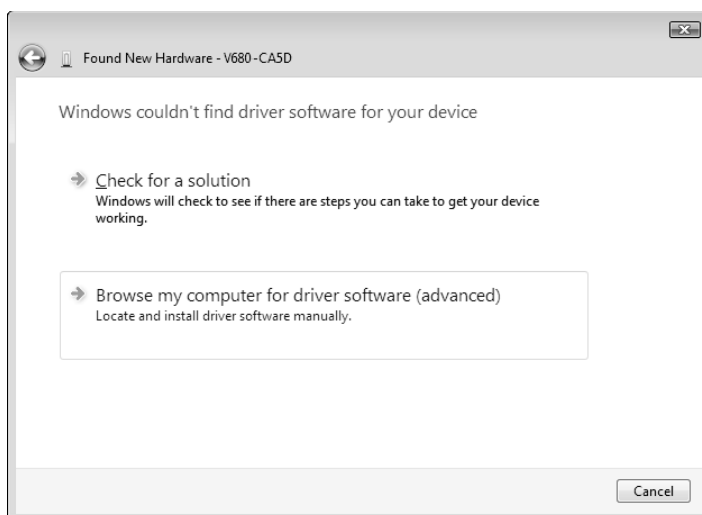

- Click the **Browse** Button, and select the folder in which the downloaded file *V680-CA5D\_200.inf* is saved. Then click the **Next** Button.

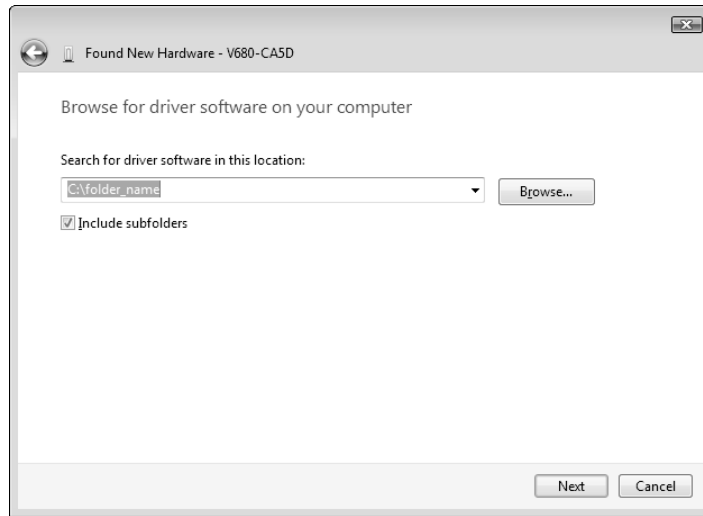

- When the following window is displayed, select **Install this driver software anyway** Button.

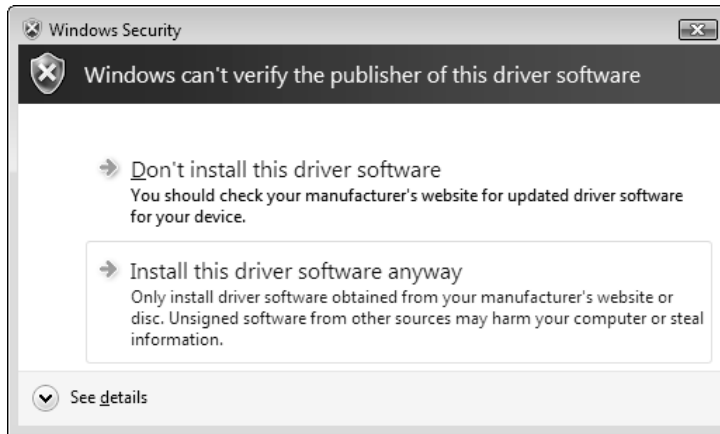

When the following window is displayed, installation is completed.

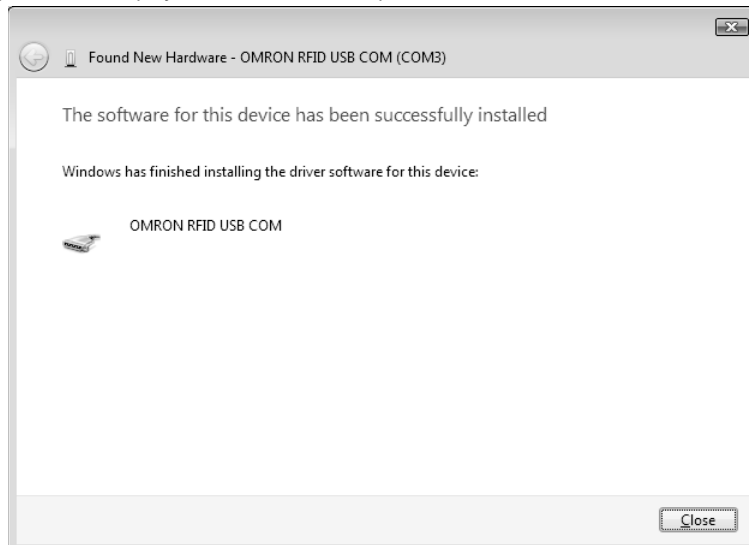

- Click the **Close** Button.

- Checking Installation  
Check that the driver is correctly installed.

1. Connect the ID Controller to the personal computer via USB.

2. Select **Control Panel - System** from the Windows Start Menu.

3. Click the **Device Manager** Button.

4. Select **Ports (COM & LPT)**, and check that OMRON RFID USB COM is displayed.  
If the driver is correctly installed, the property window for the V680-CA5D will be displayed as follows:

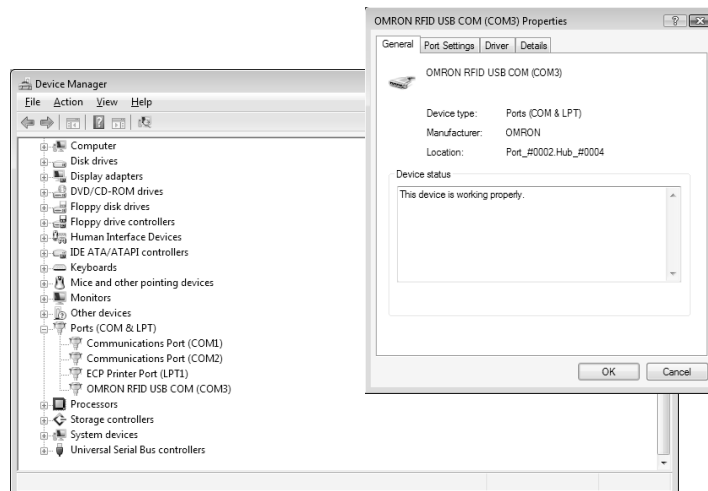

Communications with the ID Controller can be performed with the COM number displayed in parentheses after OMRON RFID USB COM.



## Antenna Port

### ■ Connecting and Removing the Connector

1. Hold the base of the connector, and insert the connector while matching the white mark on the ID Controller with the white mark on the connector.
2. Press the connector in vertically until it locks.



Be sure to hold onto the base of the connector. The connector will not lock if the ring is held.

CHECK!

3. To remove the connector, hold onto the ring and pull the connector straight out.



CHECK!

The cable cannot be removed if the base of the connector is held. Never pull excessively on the cable. Doing so will cause broken wires and damage.



CHECK!

Do not remove or connect the connector when the power is turned ON. Doing so may cause malfunctions.

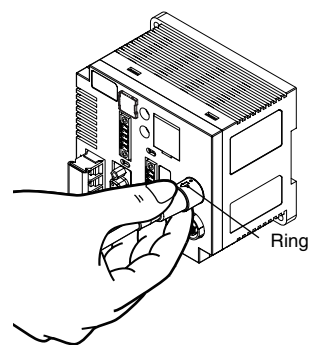
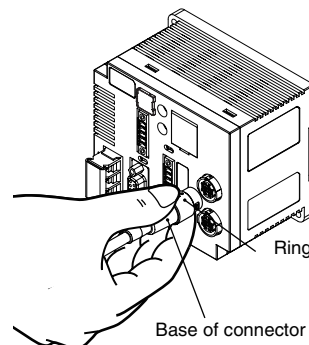

MEMO

# SECTION 3

## Preparations for Communications

☒ Switch Settings	58
☒ Trial Operation	76

# Switch Settings

## Opening the Cover

Open the cover by inserting a small screwdriver into the groove on the cover.

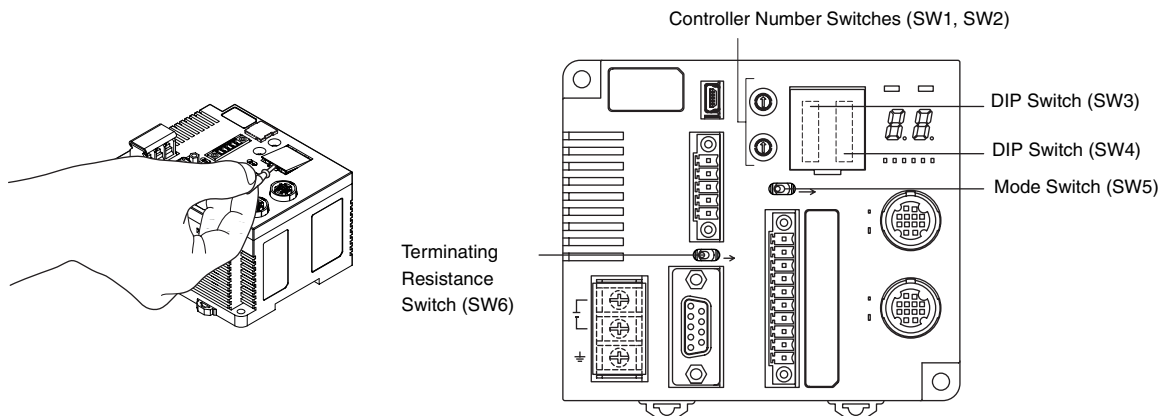

## Setting Methods

Use the provided screwdriver to make switch settings as shown in the following diagram.

- Rotary Switch Settings (SW1, SW2)

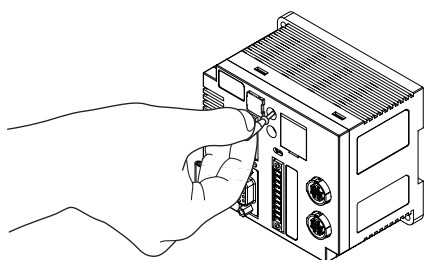

- DIP Switch Settings (SW3, SW4)

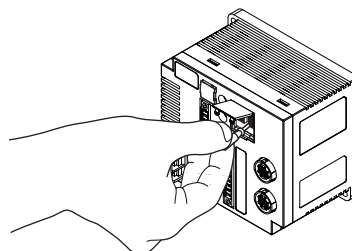

- Toggle Switch Settings (SW5, SW6)

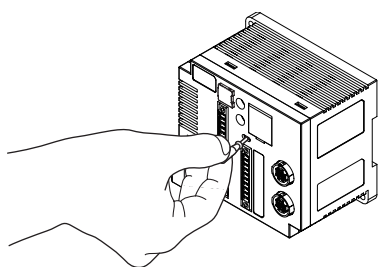

## Default Settings

	Name	Default setting	Description	Reference
SW1	Controller number upper digit (0 to 9)	0	Controller No. 00	p. 60
SW2	Controller number lower digit (0 to 9)	0		
SW3, pin 1	SW enable switch	OFF	DIP Switches enabled	p. 61
SW3, pin 2	Reserved by system.	OFF	(Not used)	
SW3, pin 3	Baud rate setting 1	OFF	Baud rate: 9600 bps	
SW3, pin 4	Baud rate setting 2	OFF		
SW3, pin 5	Data length	OFF	Data length: 7 bits	
SW3, pin 6	Parity 1	OFF	Parity: Even	
SW3, pin 7	Parity 2	OFF		
SW3, pin 8	Stop bit length	OFF	Stop bits: 2	
SW3, pin 9	Communications protocol	OFF	1:1	
SW3, pin 10	Command system	OFF	V680 commands	
SW4, pin 1	Test Mode switch setting 1	OFF	Distance level measurement	p. 62
SW4, pin 2	Test Mode switch setting 2	OFF		
SW4, pin 3	Test Mode switch setting 3	OFF		
SW4, pin 4	Antenna specification for test execution	OFF	Antenna 1	
SW4, pin 5	Write verification	OFF	With write verification	
SW4, pin 6	Lower trigger execution setting	OFF	None	
SW4, pin 7	Write protection function disable	OFF	Enabled	
SW4, pin 8	V680-H01 Antenna connection setting	OFF	Connection to antennas other than the V680-H01	
SW4, pin 9	Run Mode setting	OFF	Command Execution Mode	
SW4, pin 10	High-speed Data Transmission setting	OFF	Normal mode	
SW5	Mode switch	OFF	Run Mode	p. 63
SW6	Terminating resistance	OFF	No terminating resistance	

■ **Controller Number Switch Settings (SW1, SW2)**

■ **Controller Numbers**

If more than one Controller is connected to a single host device, the host device must be able to distinguish them. For this reason, a different Controller number must be set for each Controller. Controller numbers are included in 1:N protocol commands and responses. Communications are not possible if the Controller numbers are not set correctly.



SW1 and SW2 are enabled only when the DIP switch is enabled (i.e., when pin 1 on SW3 is OFF). If the internal settings are enabled (i.e., if pin 1 on SW3 is ON), the values specified by the PARAMETER SET (SP) command will be enabled.

CHECK!

p. 230

■ **Setting Controller Numbers**

SW1	SW2	Controller No.
Upper digit	Lower digit	
0	0	0
0	1	1
0	2	2
0	3	3
0	4	4
0	5	5
0	6	6
0	7	7
0	8	8
0	9	9
1	0	10
1	1	11
:	:	:
2	9	29
3	0	30
3	1	31
3	2	Setting prohibited
3	3	Setting prohibited
:	:	:
9	9	Setting prohibited

**Setting Examples**

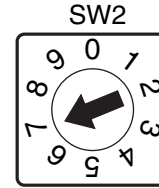
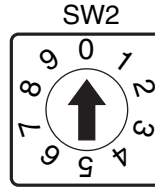
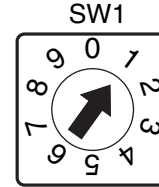
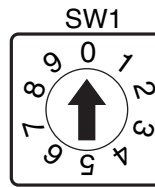

Controller No. 0

Controller No. 17

The Controller number switch is factory-set to 00.



Do not set the Controller number switch to between 32 and 99.

CHECK!



When rotary switch SW1 is set to 8, the ID Controller will be in Host Communications Trigger Send Mode. If the mode switch is turned OFF in this mode, a response frame will be sent to the host device.

CHECK!

p. 74

## ■ DIP Switch Settings (SW3, SW4)

### ■ SW3, Pin 1 (SW Enable Switch)

SW3, pin 1	Description
OFF	DIP switch enabled
ON	Internal settings enabled

**Note:** SW1, SW2, SW3 (pins 3 to 9), and SW4 (pins 5 to 7) are enabled only when the DIP switches are enabled.



When the internal settings are enabled, the values specified by the TR and SP commands are valid.

The default values will be enabled if values have not been specified using the TR and SP commands.

CHECK!  p. 228, p. 230

### ■ SW3, Pin 2 (Reserved by System)

Do not use this pin. Always set this pin to OFF.

### ■ SW3, Pins 3 and 4 (Baud Rate)

SW3, pin 3	SW3, pin 4	Description
OFF	OFF	9,600 bps
	ON	19,200 bps
ON	OFF	38,400 bps
	ON	115,200 bps

### ■ SW3, Pin 5 (Data Length)

SW3, pin 5	Description
OFF	7 bits
ON	8 bits

### ■ SW3, Pins 6 and 7 (Parity)

SW3, pin 6	SW3, pin 7	Description
OFF	OFF	Even
	ON	None
ON	OFF	Odd
	ON	Even

### ■ SW3, Pin 8 (Stop Bit Length)

SW3, pin 8	Description
OFF	2 bits
ON	1 bit

### ■ SW3, Pin 9 (Communications Protocol)

SW3, pin 9	Description
OFF	1:1
ON	1:N

▪ **SW3, Pin 10 (Command System)**

SW3, pin 10	Description
OFF	V680 commands
ON	V600 commands

▪ **SW4, Pins 1, 2, and 3 (Maintenance Mode Switch Settings)**

SW4, pin 1	SW4, pin 2	SW4, pin 3	Description
OFF	OFF	OFF	Distance Level Measurement Mode
		ON	Tag Communications Test Mode
	ON	OFF	Speed Level Measurement Mode, Read
		ON	Speed Level Measurement Mode, Write
ON	OFF	OFF	Noise Level Measurement Mode
	ON	OFF	Communications Success Rate Measurement Mode
		ON	Host Communications Monitor Mode



CHECK!

Maintenance Mode cannot be used when the V680-H01 Antenna is connected.



CHECK!

For details, refer to *Maintenance Mode*.



p. 66

▪ **SW4, Pin 4 (Antenna Specification)**

SW4, pin 4	Description
OFF	Antenna 1
ON	Antenna 2

**Note:** This setting is valid only in Maintenance Mode.

▪ **SW4, Pin 5 (Write Verification)**

SW4, pin 5	Description
OFF	With write verification
ON	Without write verification

▪ **SW4, Pin 6 (Lower Trigger Execution)**

SW4, pin 6	Description
OFF	None
ON	Enabled (on rising edge)

**Note:** This setting is valid only when pin 10 on DIP switch SW3 (command system) is ON.

▪ **SW4, Pin 7 (Write Protection Function)**

SW4, pin 7	Description
OFF	Enabled
ON	Disabled



■ SW4, pin 8 (V680-H01 Antenna connection setting)

SW4, pin 8	Description
OFF	Connection to antennas other than the V680-H01
ON	Allows connection of the V680-H01 Antenna.



CHECK!

The V680-H01 Antenna can be connected only to the V680-CA5D01-V2 ID Controller. It cannot be used with the V680-CA5D02-V2 ID Controller.

■ SW4, Pin 9 (Run Mode)

SW4, pin 9	Description
OFF	Command Execution Mode
ON	Self-execution Mode



CHECK!

Self-execution Mode will not work if pin 10 on DIP switch SW3 (V600 commands) is ON.

■ SW4-10 (High-speed Data Transmission setting)

SW4, pin 8	Description
OFF	Normal mode
ON	High-speed mode



CHECK!

The high-speed mode cannot be used with the V680-H01 Antenna.



CHECK!

For information on communication times, refer to *Tag Communications Time and Turn Around Time (Reference)*. When using multi-access, selective, or FIFO communications options, normal-mode communications speed will be used regardless of this setting.

 p. 257

■ Mode Switch Setting

SW5	Description
OFF	Run Mode
ON	Maintenance Mode



CHECK!

Maintenance Mode cannot be used when the V680-H01 Antenna is connected.

■ Terminating Resistance

If two or more ID Controller are connected to one host device, be sure to turn ON the terminating resistance of only the Controllers or host devices at each end of the serial connection and turn OFF the terminating resistance of any other device. Incorrect settings will result in unstable operation.

This switch is used to set internal terminating resistance.

SW6	Description
OFF	Terminating resistance OFF
ON	Terminating resistance ON

## Operation Modes

The V680-CA5D01/02 ID Controller has two operation modes: Run Mode and Maintenance Mode.

### Run Mode

There are two Run Modes: Command Execution Mode and Self-execution Mode.

The Run Mode at startup (when the power is turned ON) can be selected using pin 9 on SW4. The mode can also be changed by executing an OPERATION MODE CHANGE command (MO) from the host device.

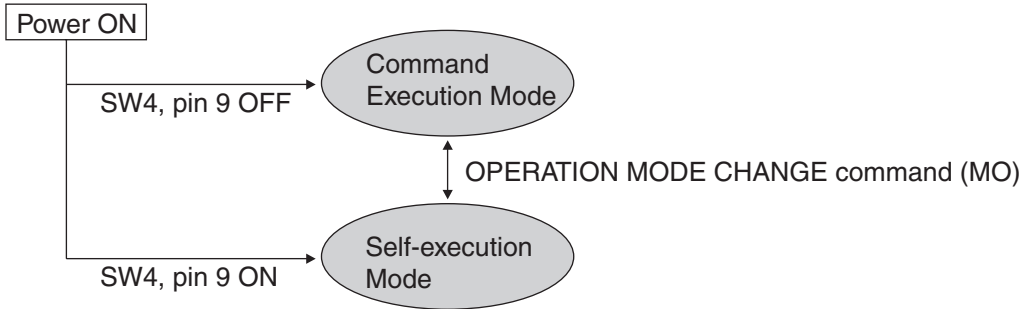

### Command Execution Mode

In this mode, commands are executed from the host device to perform operations and the results are returned to the host device as responses.

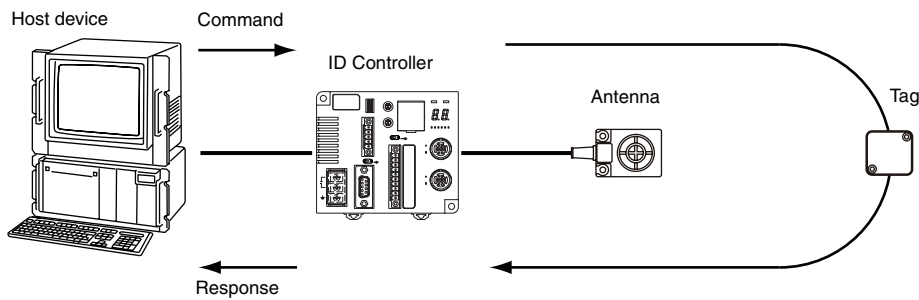

▪ Self-execution Mode



The operation conditions must be registered in Command Execution Mode using the OPERATION CONDITION SET (SE) command.

CHECK!

p. 153

Self-completion operation can be performed so that communications with Tags are automatically executed according to the operation conditions registered in the ID Controller, the results of communications with the Tags are judged (judgment conditions), and the results are output to the four external outputs (OUT1, OUT2, OUT3, and OUT4) or the RS-232C port. A very simple system can be built because the ID Controller does not need to be controlled from the host device.

The following operation conditions can be registered.

Item	Settings
Execution processing	Only Tag communications commands can be used. The only RA and RI communications modes can be used.
Judgment conditions	One of the following can be set for each output. 1) Output judgment of Tag communications results. 2) Output results of comparing response data to set data.
Result output	The following five outputs can be set for when judgement conditions have been met. (See note.) Judgement conditions can be set for each output. 1) Output to OUT1. The output time can be set. 2) Output to OUT2. The output time can be set. 3) Output to OUT3. The output time can be set. 4) Output to OUT4. The output time can be set. 5) Return the response to the host computer.

**Note:** There are 2 external outputs (OUT1 and OUT2) if the I/O arrangement is set to the same I/O arrangement as the V600(V680-CA5D□□-V2).



Self-execution Mode will not work if the V600 command system is set. For the V680 command system, either 2 outputs (default setting of 0) or 4 outputs can be switched. Refer to *PARAMETER SET (SP)* for details.

CHECK!

p. 147



The operation conditions are stored in the ID Controller's internal non-volatile memory and do not need to be set again each time the power is turned ON.

CHECK!

## ■ Maintenance Mode

Maintenance Mode is used to perform tests corresponding to actual operation. Maintenance Mode can be used to simply measure the communications performance in a particular environment, making it useful for checking during system installation and operation.

The following five modes are available within Maintenance Modes.

Mode	Description
Distance Level Measurement Mode	Measures the Antenna and Tag installation distance in relation to the Tag communications range and displays the result on the bar indicator.
Tag Communications Test Mode	Communications with Tags and displays the end code on the monitor display to indicate the result.
Speed Level Measurement Mode	Measures the number of times that communications can be performed consecutively based on the speed Tags pass through the Antenna communications range and displays the result as a speed level on the bar indicator and monitor display.
Noise Level Measurement Mode	Measures the ambient noise level in the installation environment and displays the result on the monitor display.
Communications Success Rate Measurement Mode	Executes communications with a Tag 100 times with no retries and displays the result as a communications success rate on the monitor display.
Host Communications Monitor Mode	Outputs the communications commands and responses exchanged with the host device from the USB port.



Maintenance Mode cannot be used when the V680-H01 Antenna is connected.  
Regardless of the mode setting, the Unit will operate in Tag Communications Test Mode.

CHECK!

## ■ Using Maintenance Mode

### 1. Set Test Mode.

Set pins 1 to 3 on DIP switch SW4 to the Test Mode to be used.

p. 62

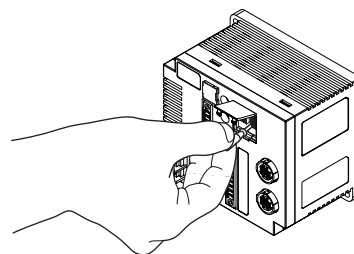

### 2. Set the Mode Switch (SW5).

Turn ON the power and turn ON the mode switch (SW5) to change to Maintenance Mode.



If the power is turned ON with the mode switch (SW5) already set to ON, the Controller will enter Maintenance Mode.

CHECK!

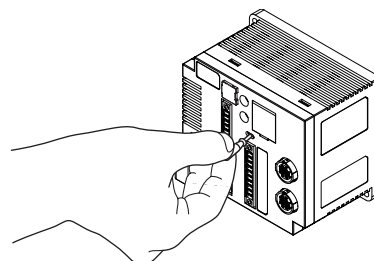

If the power supply is turned ON with the mode switch (SW5) turned ON, the ID Controller will start in Maintenance Mode. If Maintenance Mode is entered during command execution (other than in Host Communications Monitor Mode), all current processing will be canceled. If a write command was being executed, part of the contents of the Tag may have been overwritten.

CHECK!



To switch to another mode, change the Test Mode on pins 1 to 3 on DIP switch SW4 then turn ON the mode switch (SW5).

CHECK!

Distance Level Measurement Mode

Distance Level Measurement Mode can be used to easily check the installation positions of Antennas and Tags without connecting to a host device. In this mode, the monitor display and bar indicator show how far the installation distance between Antenna and Tags is in relation to the communications range.

 The distance level changes dramatically depending on the ambient environment. Use it as a guide for the installation position and perform sufficient tests in Run Mode in the actual installation environment. Levels higher than distance level 4 may not be displayed, but this does not indicate an error and performance in Run Mode will not be affected.

**CHECK!** level 4 may not be displayed, but this does not indicate an error and performance in Run Mode will not be affected.

1. Change to Distance Level Measurement Mode.

SW4, pin 1: OFF, SW4, pin 2: OFF, SW4, pin 3: OFF, SW5: ON

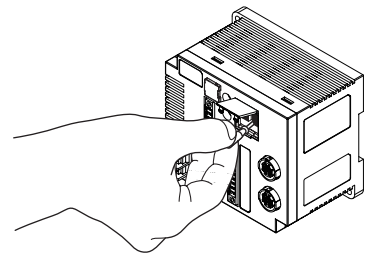

2. Place Tags within the Antenna communications range.

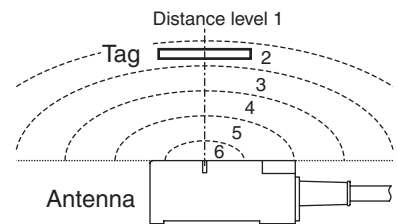

3. The distance level will be displayed on the bar indicator and monitor display.

The level at which normal reading was possible will be displayed between 01 and 06. If there is no Tag in the Antenna's communications area, "--" will be displayed. The measurement result is also output from the USB port.

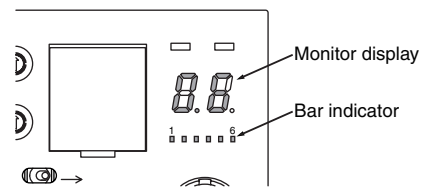

Output from the USB Port

The distance level and Antenna channel are output from the USB port.

DL 06 1 0 \* [CR]

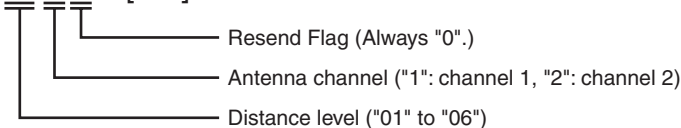

▪ **Speed Level Measurement Mode (Read/Write)**

Speed Level Measurement Mode can be used to check the Tag movement speed and applicable number of bytes without connecting to a host device. In this mode, the margin available for the Tag movement speed in relation to the number of bytes being accessed is displayed on the bar indicator.



The Speed Level Measurement Mode simulates writing data. Actually data is not written to the Tag.



The speed level is measured for the number of test bytes set in advance using the PARAMETER SET (SP) command. Refer to *PARAMETER SET (SP)* for details.

p. 147

**1. Change to Speed Level Measurement Mode.**

**Reading**

SW4, pin 1: OFF, SW4, pin 2: ON, SW4, pin 3: OFF, SW5: ON

**Writing**

SW4, pin 1: OFF, SW4, pin 2: ON, SW4, pin 3: ON, SW5: ON

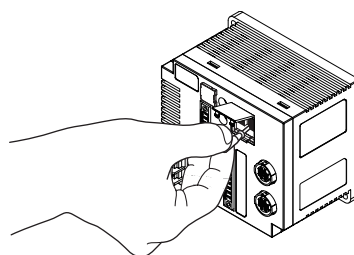

**2. Move the Tags.**

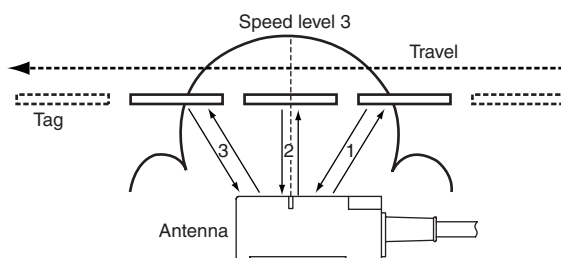

**3. The speed level will be displayed on the bar indicator and monitor display.**

The number of successful communications between 01 and 99 is displayed on the monitor display. (“-” is displayed to indicate standby status.) The display will show 99 even if more than 99 successful communications were made. “EE” will be displayed if the first communication after the Tag entered the communications area fails. The bar indicator will show the speed level. One LED in the bar indicator will light for each 2 successful communications (all six LEDs will be lit after 12 successful communications). The measurement result is also output from the USB port.

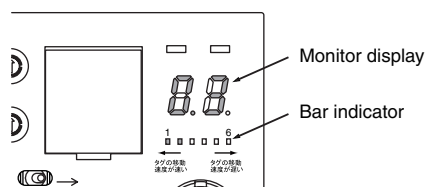

**Output from the USB Port**

The number of successful communications and the Antenna channel are output from the USB port.

SL 99 1 0 \* [CR]

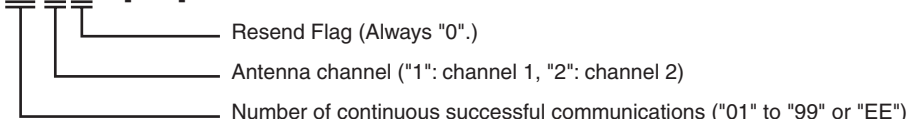

▪ **Noise Level Measurement Mode**

Noise Level Measurement Mode enables checking spatial noise, noise sources, and the effectiveness of noise countermeasures without connecting to a host device. This mode measures the noise level in the surrounding environment and displays the result on the monitor display. A noise level between 00 and 99 can be output from the USB port as the result.

**1.** Change to the Noise Level Measurement Mode.

SW4, pin 1: ON, SW4, pin 2: OFF, SW4, pin 3: OFF, SW5: ON

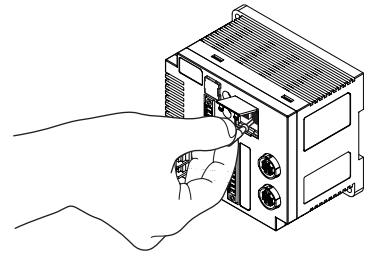

**2.** Measuring the noise level will be started.

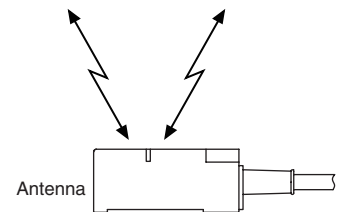

**3.** The noise level measurement results will be displayed on the monitor display.

The noise in the surrounding environment is displayed between "00" and "99".  
The measurement result is also output from the USB port.

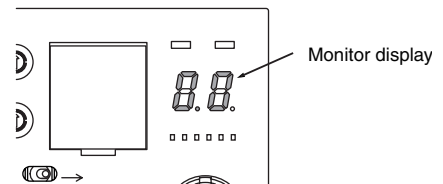

**Output from the USB Port**

The noise level and Antenna channel are output from the USB port.

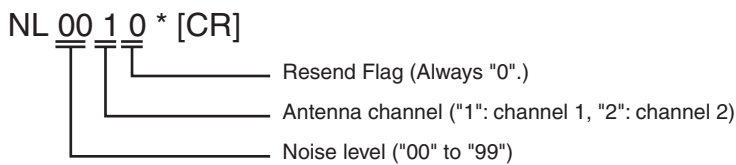

▪ **Communications Success Rate Measurement Mode**

Communications Success Rate Measurement Mode can be used to check the percentage of communications that are successful without connecting to a host device. This mode displays the rate of successful communications without retries between Antennas and Tags on the monitor display.



Data is read to measure the communications success rate.

**1.** Change to Communications Success Rate Measurement Mode.

SW4, pin 1: ON, SW4, pin 2: ON, SW4, pin 3: OFF, SW5: ON

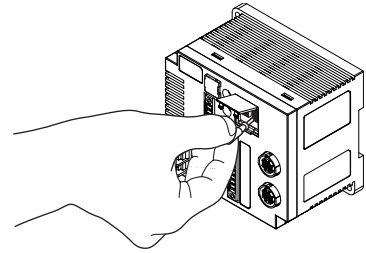

**2.** Place a Tag inside the Antenna communications range.

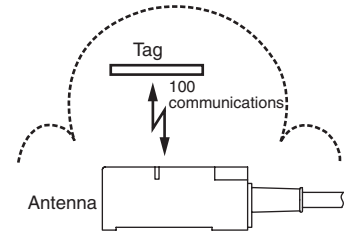

**3.** The communications success rate will be displayed on the monitor display.

The communications success rate is displayed between 00 and 99 (%). If no communications were successful, "EE" will be displayed. If all communications were successful, "FF" will be displayed. The measurement result is also output from the USB port.

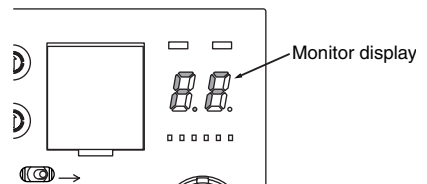

**Output from the USB Port**

The communications success rate and the Antenna channel are output from the USB port.

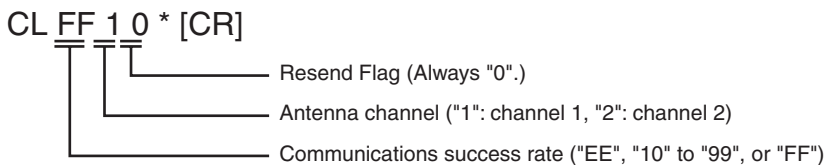





▪ Host Communications Monitor Mode (Protocol Analyzer)

Commands sent by serial communications (RS-232C, RS-422, or RS-485) from the host device and execution result responses can be output to the monitor port (USB) to enable application as a host communications line protocol analyzer.

1. Change to Monitor Mode.

SW4, pin 1: ON, SW4, pin 2: ON, SW4, pin 3: ON, SW5: ON

 The mode can also be changed by executing an OPERATION MODE CHANGE command (MO) from the host device while in Run Mode.  
**CHECK!**  p. 151

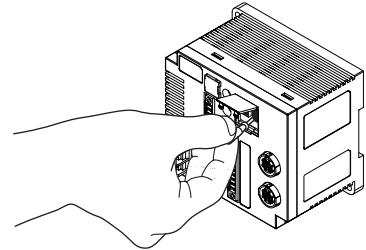

2. Connect a monitor device (e.g., a personal computer) to the ID Controller via the USB port.

3. Commands and responses from communications with the host device will be output to the monitor device.

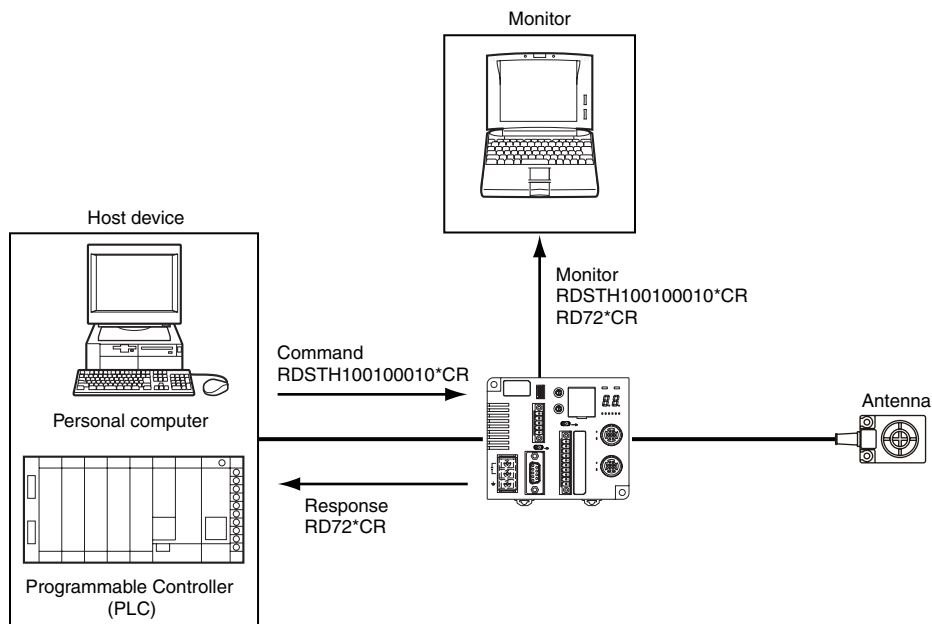

■ **Convenient Functions**

▪ **Tag Communications Test Mode**

Tag Communications Test Mode can be used to check tag communications without connecting to a host device. In this mode, the ID Controller communicates with Tags and displays the end codes on the monitor display as the results. The measurement result is also output from the USB port to enable checking on a monitor device, e.g., when the ID Controller is installed in a panel and the monitor display is not visible.



Data is read to check tag communications. Writing is not checked.



Communications are checked using Tag communications for the number of test bytes set in advance using the PARAMETER SET (SP) command. Refer to *PARAMETER SET (SP)* for details.

 p. 147

**1.** Set the Antenna to be used and turn ON the power supply.

Antenna channel setting: SW4, pin 4

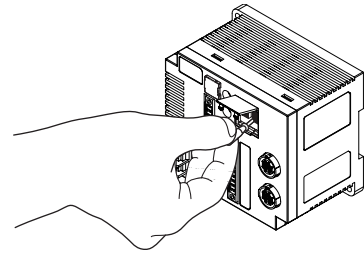

**2.** Place the ID Controller in Communications Test Mode.

SW4, pin 1: OFF, SW4, pin 2: OFF, SW4, pin 3: ON, SW5: ON

**3.** Start the test.

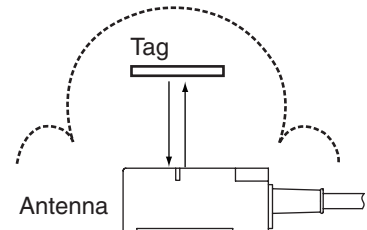

**4.** The result of communicating with the Tag is displayed on the monitor display.

The end code is displayed on the monitor display. The measurement result is also output from the USB port.

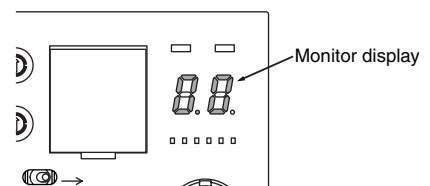

### Output from the USB Port

The end code and the Antenna channel are output from the USB port.

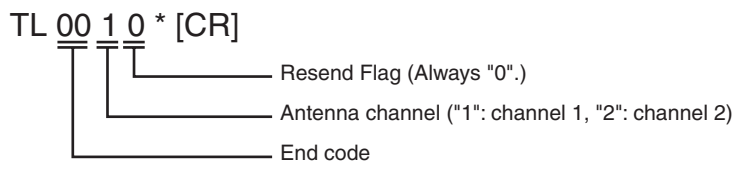

 p. 171

## ■ Host Communications Check Mode

Host Communications Check Mode can be used to check if data sent from the ID Controller is reaching the external device. In this mode, a response is sent to the host device from the ID Controller, making it easier to identify communications setting or wiring errors that cause faults in connections between ID Controllers and host devices.

1. Set pins 3 to 8 on DIP switch SW3 to the desired communications settings and turn ON the power.

 p. 61

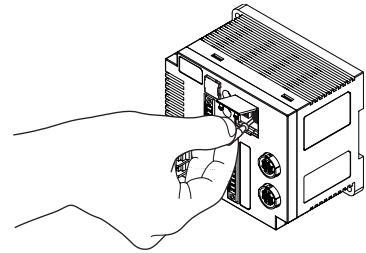

2. Turn OFF the mode switch (SW5) if it is ON.

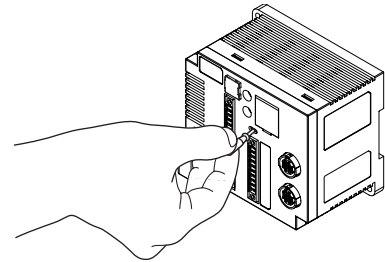

3. Set rotary switch SW1 to 8.

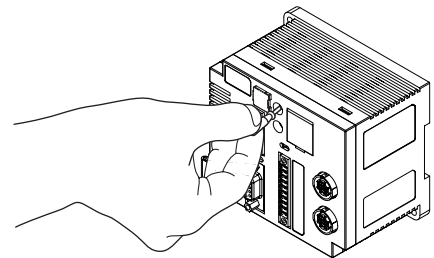

4. Turn ON the mode switch (SW5).

Response frames will be sent to the host device in the following order:

1. A response frame is sent from the RS-232C port
2. A response frame is sent from the RS-422/RS-485 port.
3. A response frame is sent from the USB port.



CHECK!

These three steps will be repeated each time the mode switch (SW5) is turned ON until rotary switch SW1 is returned to its normal setting.

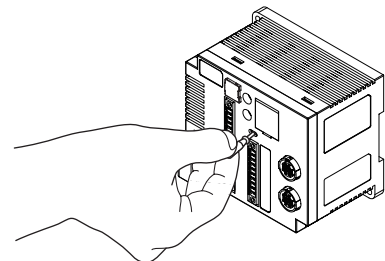

CHECK!

Always return the rotary switch (SW1) to its normal setting after completing checking communications with the host device.

**Responses to the Host Device**

· **Pin 1 on DIP Switch SW3 Turned OFF (DIP Switch Settings Enabled)**

The communications settings from pins 3 to 8 of DIP switch SW3 are output as the response.

· **Pin 1 on DIP Switch SW3 Turned ON (Internal Settings Enabled)**

The communications settings made with the COMMUNICATIONS SET (TR) command are output as the response.

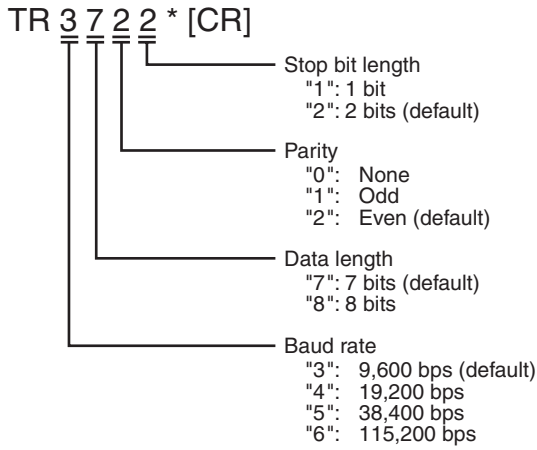

# Trial Operation

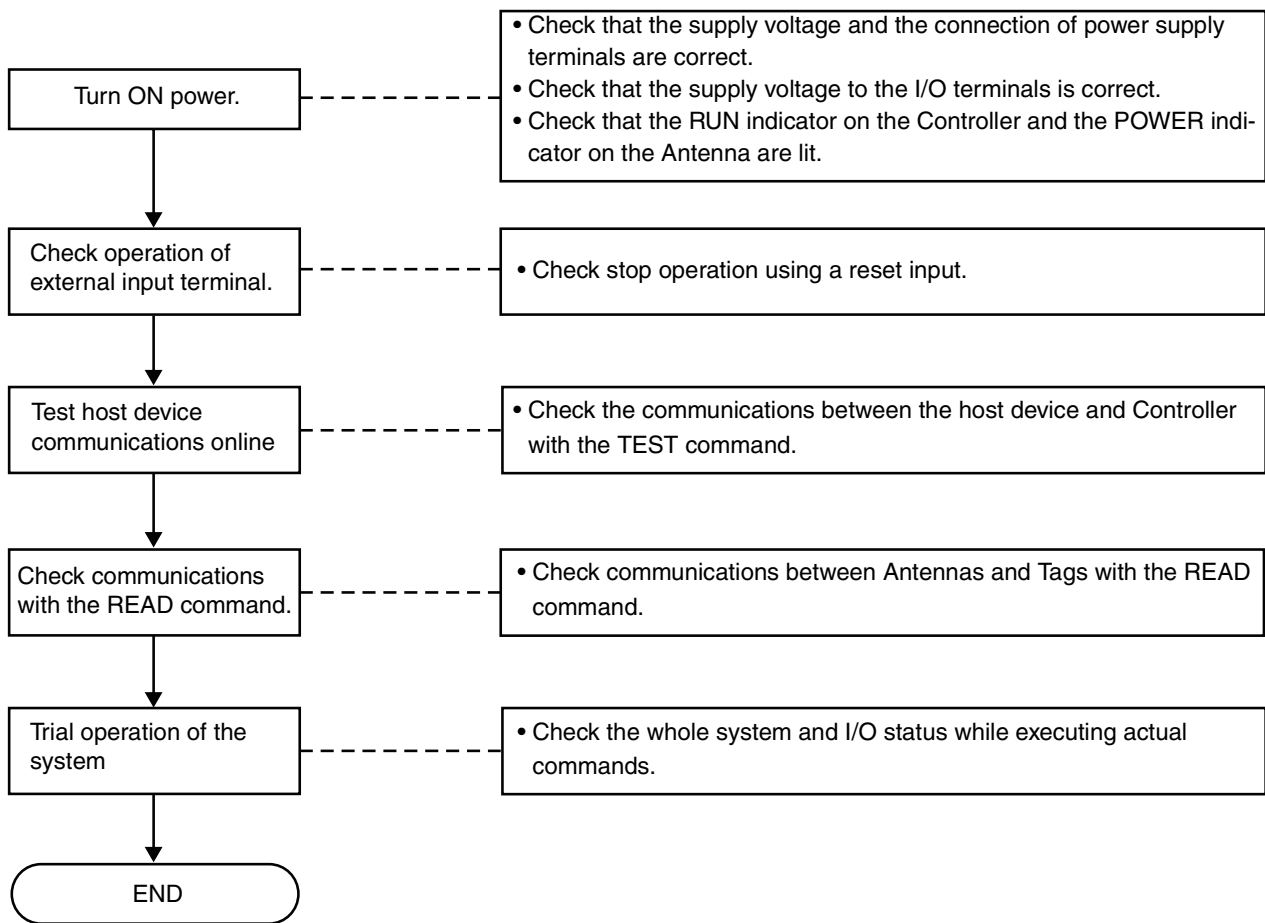

During installation, use the Maintenance Mode to adequately check the environment and installation.

CHECK!





p. 66

## Communications Test with Host Device

The TEST command is used to perform a communications test of the communications between the Controller and host device. This test enables the cable connections and processing operation of communications to be checked before the trial operation of the whole system.

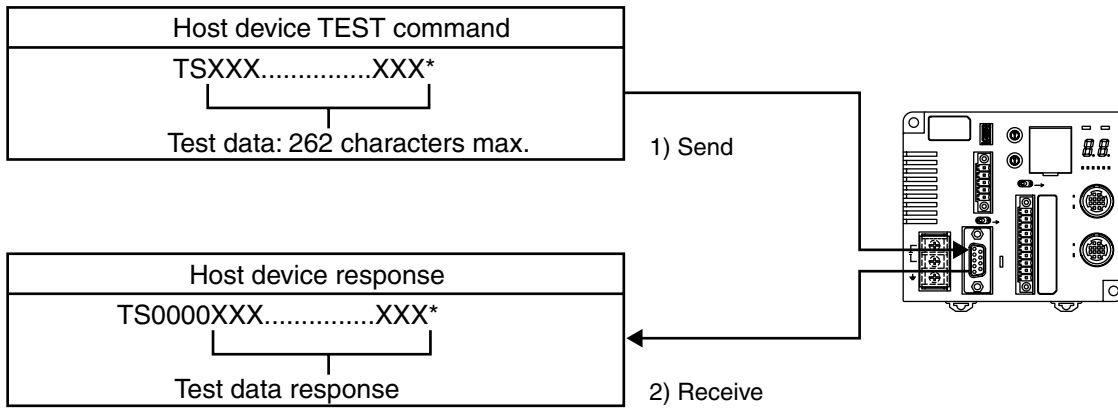
1. Create a simple communications program on the host device and send the TEST command (TS). If the communications line is normal, the Controller will return the data it received.



 Refer *TEST Command (TS)* for details on the TEST command.

CHECK!  
 p. 166

### Example

Sending Message Data “OMRON” from Controller No. 2.

#### Command

Controller No.			Command code		Message data					FCS		Terminator		
@	0	0	2	T	S	O	M	R	O	N	2	4	*	CR
1	1	2	2	5					2	2				

#### Response

Controller No.			Command code		End code	Fixed value	Resend flag	Message data			FCS		Terminator					
@	0	0	2	T	S	0	0	0	0	O	M	R	O	N	2	4	*	CR
1	1	2	2	2	2	1	1	5			2	2						

## Communications Test between Tags and the Antenna

Actual commands can be sent from the host device to test whether communications between Tags and the Antenna are normal.

- 
1. Send a READ command (communications designation “SA”) from the host device.



For details on the READ command, refer to *READ (RD)*.



p. 116

- 
2. Position a Tag near the Antenna communications surface.

---

The Controller will read the Tag data once the Tag enters the Antenna's communications area. An error code will be displayed on the monitor display if communications are not successful.



If the end code “00” is not displayed on the monitor display, check *List of End Codes* and correct the error.



p. 171



## SECTION 4

### Functions

☒ Trigger Input	80
☒ Write Protection	81
☒ Tag Service Life Check	91
☒ Tag Memory Check	93
☒ Tag Memory Error Correction	94
☒ Write Command Memory	95
☒ Noise Monitor Function	96

## Trigger Input

There is one trigger input for each Antenna (two total) which can be used to tell the ID Controller when to start Tag processing. Once the ID Controller has received a command, it will wait for the rising edge of the trigger input and then communicate with the Tag.

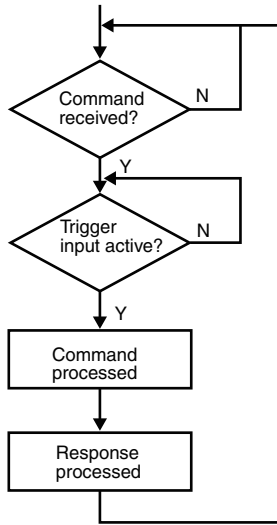

**Note:** Processing is not stopped even if the trigger input changes during command processing.

If auto commands are used, the ID Controller will wait from the rising edge of the Trigger input for a Tag to enter the communications area. This means that read/write processing will not start after a command is received until the rising edge of the trigger input, even if a Tag approaches.

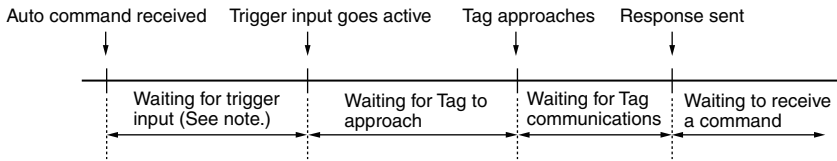

**Note:** Read/write processing will not start while the ID Controller is waiting for the trigger input, even if a Tag approaches.

## Write Protection

---

Write protection can be set to protect important data stored in the memory of an ID Tag, such as product numbers and models from being mistakenly overwritten. After important data has been written to memory, it can be write-protected using the following method.



The write protection function is supported only for these OMRON ID Controllers. It is not valid for Reader/Writers manufactured by other companies.

CHECK!

### Setting Write Protection

The ID Controller and ID Tag each have enable and disable settings for write protection. Always make the settings in both the ID Controller and ID Tag when setting write protection.

Also, the memory map for ID Tag write protection settings differs when using V680 commands and V600 commands. Use the settings that match the command being used.

#### ■ Setting Write Protection When Using V680 Commands

---

1. Set the write protection setting of the ID Controller to “Enable.”
  - Using the DIP Switch (when pin 1 on SW3 is set to OFF):
    - Pin 7 on SW4: Set write protection to “OFF” to enable write protection.
  - Using the Internal Setting (when pin 1 on SW3 is set to ON):
    - PARAMETER SET (SP) COMMAND processing code “H”: Set the write protection setting to “01” to enable write protection.



Write protection is enabled as the default setting.

CHECK!



For details on the PARAMETER SET (SP) COMMAND, refer to *Command and Response Formats*.

CHECK!



p.175

**2.** Set the write protection setting of the ID Tag.

When the start address and end address for write protection are written into ID Tag address 0000H to 0003H, the area from the start address to the end address is write-protected. The most significant bit of address 0000H is used to enable or disable write protection.

Memory Map for ID Tag Write Protection Settings

Address	Bit	7	6	5	4	3	2	1	0
0000H	Enable/ disable	Upper two digits of start address (00 to 7F)							
0001H		Lower two digits of start address (00 to FF)							
0002H		Upper two digits of end address (00 to FF)							
0003H		Lower two digits of end address (00 to FF)							

- Most Significant Bit of Address 0000H
  - 1: Write-protected (Enabled)
  - 0: Not write-protected (Disabled)
- Area in Tag Memory That Can Be Write Protected
  - Start address: 0004H to 7FFFH
  - End address: 0004H to FFFFH



CHECK!

To use write protection, use one operation to write to the write protection setting area (addresses 0000H to 0003H) and a separate operation to write to other addresses (address 0004H or higher) in the ID Tag. A write protection error will occur if the most significant bit of address 0000H is 1 and a write operation is performed that includes both addresses in the ID tag write protection settings area and other addresses in the ID Tag.



CHECK!

When write protection is not set in the write protection setting area (addresses 0000H to 0003H) of the ID Tag, the write protection setting area can be used for user memory. When the write protection setting area of the ID Tag is used for user memory, be sure to disable the write protection setting of the ID Controller.

Example of Write Protection

**Start Address Is Lower Than the End Address**

The memory area between the start address and end address will be write-protected.

Address	Bit	Upper digits				Lower digits			
		1	0	0	0	0	0	0	0
0000H		1	0	0	0	0	0	0	0
		8				0			
0001H		0	0	0	1	0	1	0	1
		1				5			
0002H		0	0	0	0	0	0	0	1
		0				1			
0003H		0	0	1	0	0	0	0	0
		2				0			

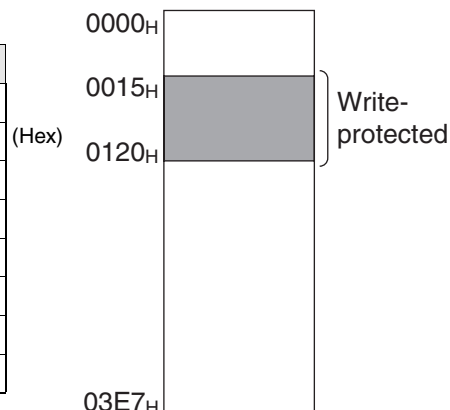

**Start Address Is Equal to End Address**

Only the selected address (one byte) will be write-protected.

Address	Bit	Upper digits				Lower digits			
		1	0	0	0	0	0	0	0
0000H		1	0	0	0	0	0	0	0
		8				0			
0001H		0	0	1	0	0	0	0	1
		2				1			
0002H		0	0	0	0	0	0	0	0
		0				0			
0003H		0	0	1	0	0	0	0	1
		2				1			

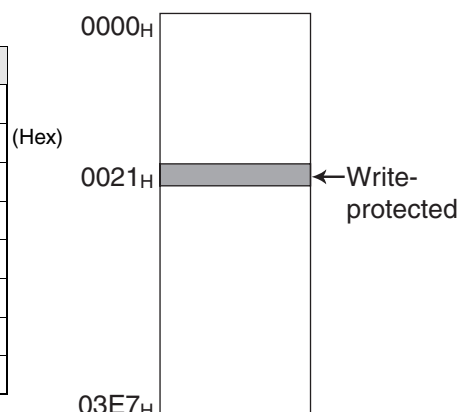

**End Address Is Higher than the Last ID Tag Address**

The memory area between the start address and the last ID Tag address will be write-protected.

Address	Bit	Upper digits				Lower digits			
		1	0	0	0	0	0	1	1
0000H		1	0	0	0	0	0	1	1
		8				3			
0001H		0	0	0	0	0	0	0	0
		0				0			
0002H		0	0	0	0	0	0	1	1
		0				3			
0003H		1	1	1	1	1	1	1	1
		F				F			

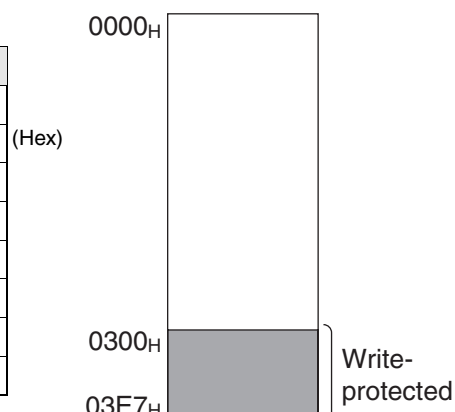

The write protection setting area of the ID Tag cannot be write-protected.

**Start Address Is Higher Than End Address**

The memory area between the start address and the last ID Tag address, as well as the area between 0004H and the end address will be write-protected.

Address \ Bit	Upper digits				Lower digits			
0000H	1	0	0	0	0	0	0	1
	8				1			
0001H	0	0	1	0	0	0	0	0
	2				0			
0002H	0	0	0	0	0	0	0	0
	0				0			
0003H	0	0	0	1	0	1	0	1
	1				5			

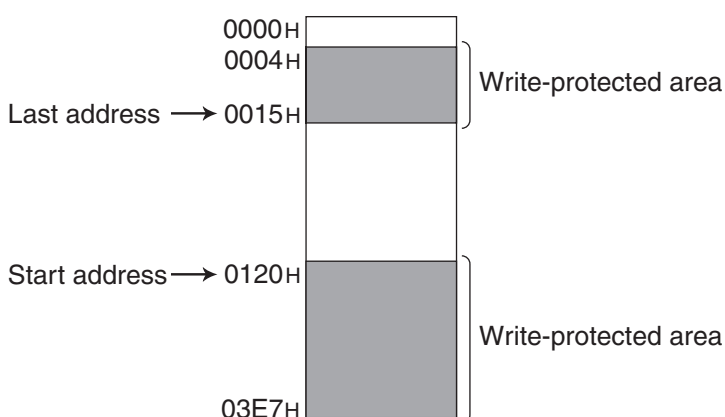

The write protection setting area of the ID Tag cannot be write-protected.

■ **Disabling Write Protection When Using V680 Commands**

▪ **Disabling ID Tag Write Protection for Part of the Area Being Used:**

To temporarily disable write protection when you want to, for example, rewrite data that is being write-protected, set the most significant bit of address 0000H for the ID Tag memory to “0.”

▪ **Disabling Write Protection for all OMRON-made RFID systems:**

To disable write protection in order to, for example, use the entire memory area of the ID Tag as user memory, use either of the following methods to set all of the ID Controllers.

- Using the DIP Switch (when pin 1 on SW3 is set to OFF):  
Pin 7 on SW4: Set write protection to “ON” to disable write protection.
- Using the Internal Setting (when pin 1 on SW3 is set to ON):  
PARAMETER SET (SP) COMMAND processing code “H”: Set the write protection setting to ”00” to disable write protection.



Precautions on Using Write Protection

The write protection function is supported only for these OMRON ID Controllers. It is not valid for reader/writers manufactured by other companies.



For details on the PARAMETER SET (SP) COMMAND, refer to *Command and Response Formats*.

CHECK!



p.175

## ■ Setting Write Protection When Using V600 Commands

There are separate write protection setting methods for the EEPROM (Battery-less) Data Carrier (V600-D23P□□) and the S-RAM (Built-in Battery) Data Carrier of the V600 Series.

When using V600 commands with a V680-series ID Controller, the conventional write protection setting method can be used by selecting the ID Controller internal setting and the ID Tag type.

- EEPROM Data Carrier: For the V680-D1KP□□, use the V600 EEPROM write protection method.
- F-RAM Data Carrier: For the V680-D2K/8K/32KF□□, use the V600 S-RAM write protection method.



The ID Controller automatically switches between the V600 EEPROM write protection method and the V600 S-RAM write protection method according to the ID Tag being used, so the user does not need to make this setting.

CHECK!



The V600 EEPROM write protection method and the V600 S-RAM write protection method can be used only on ID Controllers that are version 2.1 or newer. For details on *Checking the Version*, refer to page 17.

CHECK!

To set the same ID Tag write protection setting area for EEPROM and F-RAM, use the V680 write protection method.

### 1. Set the write protection setting of the ID Controller to “Enable.”

- Using the DIP Switch (when pin 1 on SW3 is set to OFF):  
Pin 7 on SW4: Set write protection to “OFF” to enable write protection.
- Using the Internal Setting (when pin 1 on SW3 is set to ON):  
PARAMETER SET (SP) COMMAND processing code “H”: Set the write protection setting to “1” to enable write protection.



Write protection is enabled as the default setting.

CHECK!



For details on the PARAMETER SET (SP) COMMAND, refer to *Command and Response Formats*.

CHECK!



p.175

### 2. Set the Write Protection Method

INTERNAL SET (SP) COMMAND processing code “J”: Set to either the V600 write protection method or the V680 write protection method.



For details on the PARAMETER SET (SP) COMMAND, refer to *Command and Response Formats*.

CHECK!



p.175

**3.** Set the write protection setting of the ID Tag.

▪ **Setting Write Protection for V600 EEPROM Models**  
(Setting the V600 Write Protection Method and Using the V680-D1KP□□)

When the end address for write protection is written into ID Tag address 0000H, the area from address 0001H to the end address is write-protected.

The most significant bit of ID Tag address 0000H is used to enable or disable write protection.

For this reason, addresses from 0080H to 03E7H cannot be used as end addresses.

When the end address is set to 00, the area from address 0001H to 03E7 is write-protected.



CHECK!

The V600 EEPROM write protection method and the V600 S-RAM write protection method can be used only on ID Controllers that are version 2.1 or newer. For details on *Checking the Version*, refer to page 17.

**Memory Map for V600 EEPROM ID Tag Write Protection Settings**

Address	Bit	7	6	5	4	3	2	1	0
0000H	Enable/disable	End address							

- Most Significant Bit of Address 0000H  
1: Write-protected (Enabled)  
0: Not write-protected (Disabled)
- Area in Which the End Address Can Be Set  
End address: 00H, 01H to 7FH



CHECK!

To use write protection, one operation to write to the write protection setting area (address 0000H) and a separate operation to write to other addresses (address 0001H hex or higher). A write protection error will occur if the most significant bit of address 0000H is 1 and a write operation is performed that includes both addresses in the ID tag write protection settings area and other addresses in the ID Tag.

**Example of Write Protection**  
**Write Protecting Addresses 0001H to 0012H**

Address	Bit	7	6	5	4	3	2	1	0
0000H		1	0	0	1	0	0	1	0
		9				2			

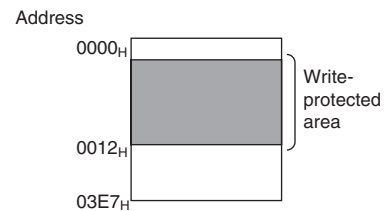

**Setting 00 as the End Address**  
**All addresses except address 0000H will be write-protected.**

Address	Bit	7	6	5	4	3	2	1	0
0000H		1	0	0	0	0	0	0	0
		8				0			

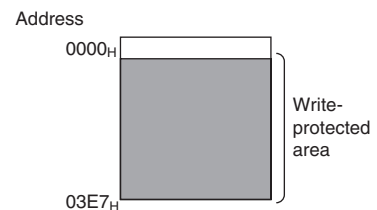

CHECK!

The write protection setting area of the ID Tag cannot be write-protected.



▪ Setting Write Protection for V600 S-RAM Model

(Setting the V600 Write Protection Method and Using the V680-D2K/8K/32K□□)

When the start address and end address for write protection are written into ID Tag addresses 0002<sub>H</sub> to 0005<sub>H</sub>, the area from the start address to the end address is write-protected.

The most significant bit of address 0002<sub>H</sub> is used to enable or disable write protection.

In V600 S-RAM write protection, addresses 0000<sub>H</sub> and 0001<sub>H</sub> are always write-protected regardless of whether write protection is enabled or disabled.



The V600 EEPROM write protection method and the V600 S-RAM write protection method can be used only on ID Controllers that are version 2.1 or newer. For details on *Checking the Version*, refer to page 17.

Memory Map for V600 S-RAM ID Tag Write Protection Settings

Address	Bit	7	6	5	4	3	2	1	0
0002 <sub>H</sub>	Enable/ disable	Upper two digits of start address (00 to 7F)							
0003 <sub>H</sub>		Lower two digits of start address (00 to FF)							
0004 <sub>H</sub>		Upper two digits of end address (00 to FF)							
0005 <sub>H</sub>		Lower two digits of end address (00 to FF)							

- Most Significant Bit of Address 0002<sub>H</sub>
  - 1: Write-protected (Enabled)
  - 0: Not write-protected (Disabled)
- Area in ID Tag Memory That Can Be Write Protected
  - Start address: 0006<sub>H</sub> to 7FFF<sub>H</sub>
  - End address: 0006<sub>H</sub> to FFFF<sub>H</sub>



To use write protection, one operation to write to the write protection setting area (addresses 0002<sub>H</sub> to 0005<sub>H</sub>) and a separate operation to write to other addresses (address 0006<sub>H</sub> or higher). A write protection error will occur if the most significant bit of address 0002<sub>H</sub> is 1 and a write operation is performed that includes both addresses in the ID tag write protection settings area and other addresses in the ID Tag.

**Example of Write Protection**

**Start Address Lower Than the End Address**

The memory area between the start address and end address will be write-protected.

Address	Bit	Upper digits				Lower digits			
0002H		1	0	0	0	0	0	0	0
		8				0			
0003H		0	0	0	1	0	1	0	1
		1				5			
0004H		0	0	0	0	0	0	0	1
		0				1			
0005H		0	0	1	0	0	0	0	0
		2				0			

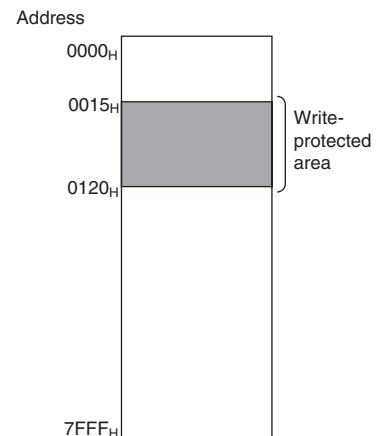

**Start Address Equal to End Address**

Only the selected address (one byte) will be write-protected.

Address	Bit	Upper digits				Lower digits			
0002H		1	0	0	0	0	0	0	0
		8				0			
0003H		0	0	1	0	0	0	0	1
		2				1			
0004H		0	0	0	0	0	0	0	0
		0				0			
0005H		0	0	1	0	0	0	0	1
		2				1			

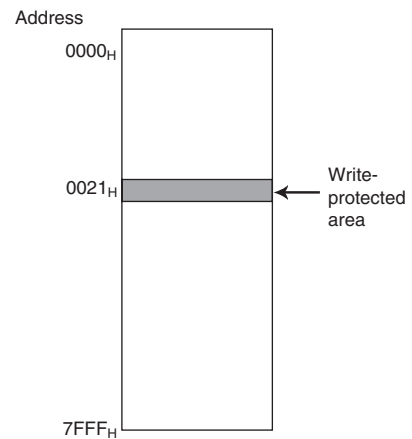

**End Address Higher than Last ID Tag Address**

The memory area between the start address and the last ID Tag address will be write-protected.

Address	Bit	Upper digits				Lower digits			
0002H		1	0	0	0	0	0	1	1
		8				3			
0003H		0	0	0	0	0	0	0	0
		0				0			
0004H		1	1	1	1	1	1	1	1
		F				F			
0005H		1	1	1	1	1	1	1	1
		F				F			

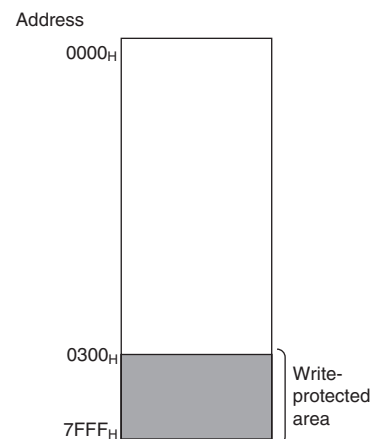

The write protection setting area of the ID Tag cannot be write-protected.  
Addresses 0000<sub>H</sub> and 0000<sub>H</sub> are always write-protected, regardless of the setting of the write protection function.

### Start Address Higher Than End Address

The memory area between the start address and the last ID Tag address, as well as the area between 0006H and the end address will be write-protected.

Address	Bit	Upper digits				Lower digits			
		1	0	0	0	0	0	0	1
0002H		1	0	0	0	0	0	0	1
		8				1			
0003H		0	0	1	0	0	0	0	0
		2				0			
0004H		0	0	0	0	0	0	0	0
		0				0			
0005H		0	0	0	1	0	1	0	1
		1				5			

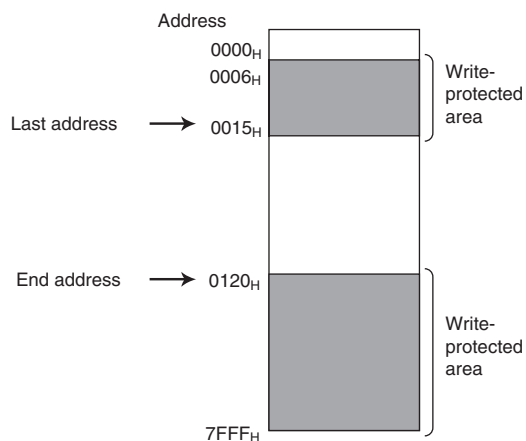

The write protection setting area of the ID Tag cannot be write-protected. Addresses 0000H and 0001H are always write-protected, regardless of the setting of the write protection function.

■ **Setting Write Protection for V680 Models**

The same method is used as that for setting ID Tags when using V680 commands. Refer to step 2 (Set the write protection function of the ID Tag) of *Setting Write Protection when Using V680 Commands*.

■ **Disabling Write Protection When Using V600 Commands**

■ **Disabling ID Tag write protection for part of the area being used:**

To temporarily disable write protection when you want to, for example, rewrite data that is being write-protected, set the most significant bit of the following address for the ID Tag memory to “0.”

- V600 EEPROM write protection                      Address 0000H
- V600 S-RAM write protection                      Address 0002H
- V600 write protection                              Address 0000H

■ **Disabling Write Protection for all OMRON-made RFID Systems:**

To disable write protection in order to, for example, use the entire memory area of the ID Tag as user memory, use either of the following methods to set all of the ID Controllers.

- Using the DIP Switch (when pin 1 on SW3 is set to OFF):  
    Pin 7 on SW4: Set the write protection setting to “ON” to disable write protection.
- Using the internal setting (when pin 1 on SW3 is set to ON):  
    PARAMETER SET (SP) COMMAND processing code “H”: Set the write protection setting to “00” to disable write protection.



**Precautions on Using Write Protection**

The write protection function is supported only for these OMRON ID Controllers. It is not valid for reader/writers manufactured by other companies.



For details on the PARAMETER SET (SP) COMMAND, refer to *Command and Response Formats*.

 p.175

## Tag Service Life Check



The OVERWRITE COUNT CONTROL command (MDS/MDL) can be used to determine whether the Tag overwrite limit has been exceeded. With the MDS command, the overwrite count is subtracted from the data in the user-specified overwrite count control area to determine whether the number of overwrites has been exceeded. The MDL command can also be used to determine whether the overwrite count (100,000 times) has been exceeded. The overwrite count is added to the data in the user-specified overwrite count control area to determine whether 100,000 overwrites has been exceeded.

### MDS Command

The overwrite count control area consists of 3 bytes from the specified start address. The decrement value from the overwrite count is written in this area, and if this value is 0 (00 hex), an end code 76 will be given as a warning. Therefore, to enable control of the number of overwrites, the maximum number of overwrites must be written to the overwrite count control area beforehand.

The user-specified number of overwrites can be set to up to 16,700,000. The overwrite life of EEPROM ID Tags is 100,000 (0186A0 hex) at 25°C or lower. Set the maximum number of overwrites to 100,00 or less. The number of overwrites is written to the control area using a hexadecimal value, and can be read using the READ command.

If the control area data is already 0, the control area value will not be refreshed, and only a warning will be returned as a response. When the refresh count is set as 00 hex, the count will not be updated, and only an overwrite count check will be performed.

 For details on the command format, refer to *OVERWRITE COUNT CONTROL (MD SL)*.  
CHECK!  p. 123

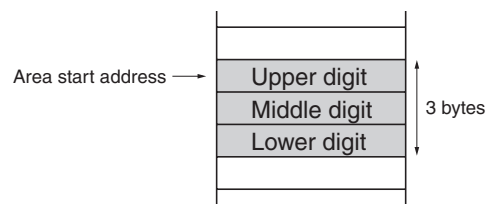

#### Example Using the OVERWRITE COUNT (MDS) Command

The overwrite count control area consists of 3 bytes starting from address 0010H.

1) The overwrite count of 100,000 times is written.

“WTSTH100100186A0”

0010	01H
0011	86H
0012	A0H

2) The overwrite count of 5 is written.

“MDSTS1001005”

The count is decremented 5 times from 100,000 to produce the following.

0010	01H
0011	86H
0012	9BH

3) The following memory status will exist after the accumulated decremented count is 100,000 times.

If “MDSTS1001000” is executed now, “MD76”

(overwrite count exceeded) will be returned.

0010	00H
0011	00H
0012	00H

■ **MDL Command**

The overwrite count control area consists of 3 bytes from the specified start address. The increment value from the overwrite count is written to this area, and if this value is 100,000 (0186A0 hex) or higher, an end code of 76 will be given as a warning. The number of overwrites is controlled using a hexadecimal value, and can be read using the READ command.

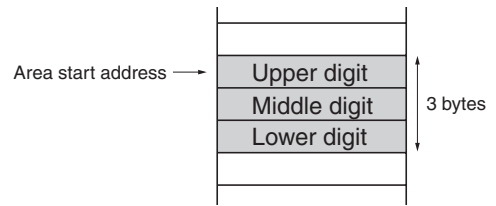

If the control area data is already 100,000 or higher, the control area value will not be refreshed, and only a warning will be returned as a response. When the refresh count is set as 00 hex, the count will not be updated, and only an overwrite count check will be performed.



For details on the command format, refer to *OVERWRITE COUNT CONTROL (MD S/L)*.

 p. 123

■ **Example Using Overwrite Count Control Command (MDL)**

In the following example, the three bytes starting from address 0010H is the overwrite count control area.

1)The control area is cleared.

“WTSTH1001000000”

0010	00H
0011	00H
0012	00H

2)The overwrite count of 4 is entered.

“MDSTL1001004”

0010	00H
0011	00H
0012	04H

3)Next, the overwrite count of 5 is entered.

“MDSTL1001005”

The total overwrite count becomes 9 times.

0010	00H
0011	00H
0012	09H

4)The following memory status will exist after the accumulated count has reached 100,000 times.

If “MDSTS1001000” is executed now, “MD7610” (overwrite count exceeded) will be returned.

0010	01H
0011	86H
0012	A0H



Do not execute the MDS command and MDL command for the same Tag. Doing so will prevent managing the service life.

## Tag Memory Check

The DATA CHECK command (MD C/K) performs a memory check. A CRC (Cyclic Redundancy Check) code calculation, write, and comparison are made using the check block unit specified by the user. The CRC code is calculated from the generated polynomial expression  $x^{16} + x^{12} + x^5 + 1$ .

The calculation area is the portion of the check block specified by the start address and the number of bytes excluding the last two bytes. The last two bytes are the check code area.

When check code write is specified (process designation: K), the CRC of the calculation area data is calculated and written to the check code area. When data comparison is specified (process designation: C), the CRC of the calculation area data is calculated and a comparison made with the check code area data. If they coincide, an end code of 00 will be returned for the V680 command (75 will be returned for the V600 command), and if they do not coincide, an end code of 76 will be returned as a warning.

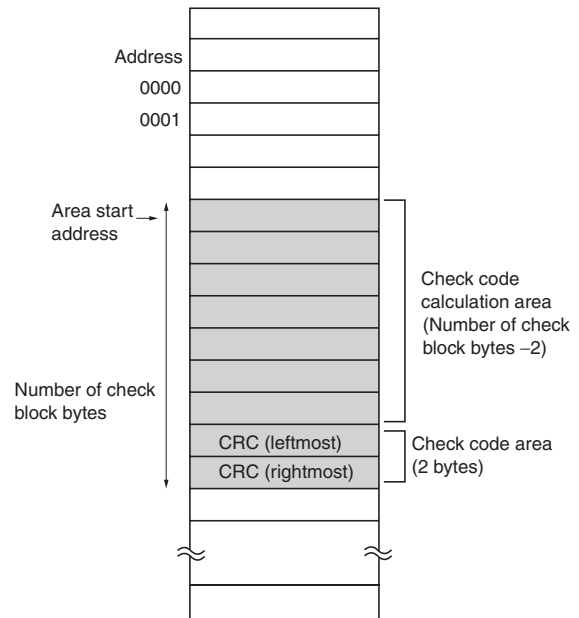

For details on the command format, refer to *DATA CHECK (MD C/K)*.

p. 125

### ■ Example of Tag Memory Check

In the following example, the data in address 0010H to 0012H is checked.

- 1) In this example, the following data already exists in the memory.
- 2) Execute MDSTK1001005 (code calculation).  
The CRC code 5CD6 calculated from the data 123456 is written to addresses 0013H and 0014H.

0010	12H
0011	34H
0012	56H
0013	
0014	

0010	12H
0011	34H
0012	56H
0013	5CH
0014	D6H

- 3) Execute MDSTC1001005 (code verification).  
The normal response MD0010 will be returned if the data coincides.

If a data error occurs, MD7610 (a data error warning) will be returned.

0010	12H
0011	34H
0012	56H
0013	5CH
0014	D6H

0010	00H	← Data error
0011	34H	
0012	56H	
0013	5CH	
0014	D6H	

# Tag Memory Error Correction

The WRITE TAG MEMORY ERROR CORRECTION (QW) command writes a tag memory check and 5-byte error correct code after the write data. The READ TAG MEMORY ERROR CORRECTION (QR) command performs a tag memory check and makes 1-bit memory error corrections.

When a 1-bit memory error is corrected, an end code of 77 will warn that a 1-bit memory error occurred, and the normal data with the error corrected will be returned.

When a memory error of 2 bits or more is detected, an end code of 76 will warn that a fatal error occurred, and the read data will not be returned.

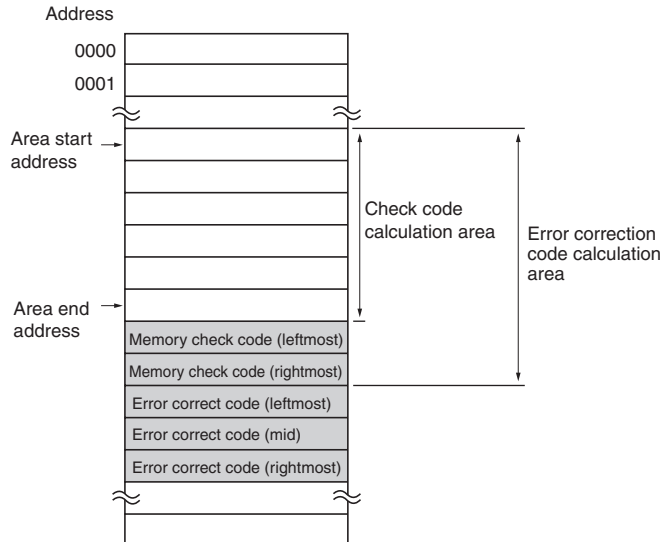

For details on the command format, refer to *READ TAG MEMORY ERROR CORRECTION (QR) and WRITE TAG MEMORY ERROR CORRECTION (QW)*.

p. 136, p. 138

## ■ Example of Tag Memory Error Correction

In the following example, the data in address 0010H to 0015H is checked.

- 1) Send WRITE TAG MEMORY ERROR CORRECTION (QW).  
Command: QWSTH10010313233343536 \* (CR)
- 2) Data is written to address 0010H to 0015H, then a tag memory check and 5-byte error correct code are written to address 0016H to 001AH.

Address		
0010	31	Write data (check code calculation area)
0011	32	
0012	33	
0013	34	
0014	35	
0015	36	
0016	FD	Memory check code (leftmost)
0017	11	Memory check code (rightmost)
0018	00	Error correct code (leftmost)
0019	0C	Error correct code (mid)
001A	3C	Error correct code (rightmost)

- 3) Send READ TAG MEMORY ERROR CORRECTION (QR).  
Command: QRSTH100100006 \* (CR)

- When the read data coincides:  
Response: QR0010313233343536 \* (CR)
- When a memory error of 2 bits or more is detected:  
Response: QR76 \* (CR)
- When a 1-bit memory error is corrected:  
Response: QR7710313233343536 \* (CR)



# Write Command Memory

A write command executed by the V680-CA5D01/02 ID Controller is stored in memory until the next write command is executed or until the power is reset. Write commands include WRITE, EXPANSION WRITE, AUTO WRITE, and POLLING AUTO WRITE. The write command stored in memory can be executed using the WRITE REPEAT (RP) command.

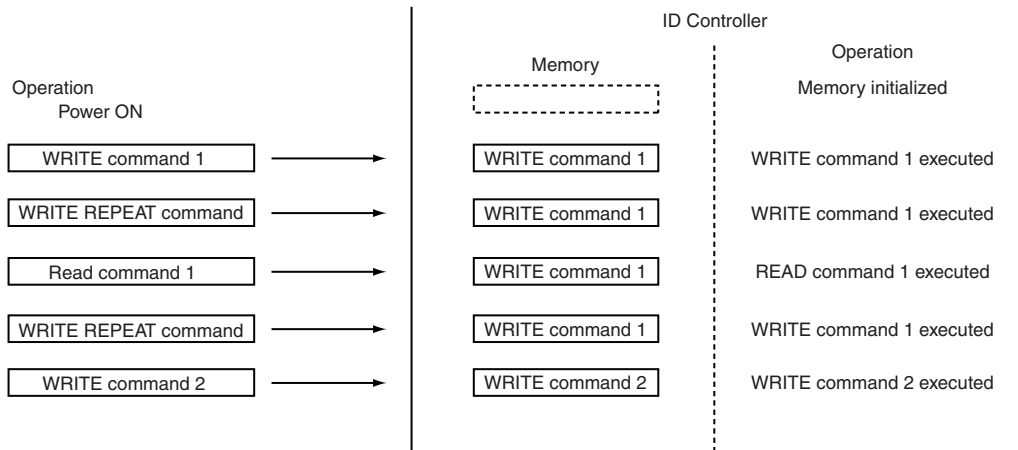

# Noise Monitor Function

When executing commands for Tag communications, the maximum value of the noise level can be attached to the response data to constantly monitor noise conditions.



The noise monitor function cannot be used when the V680-H01 Antenna is connected.



To use the noise monitor function it must be enabled using the *PARAMETER SET (SP)* command.



## ■ Response Examples

### ● Noise Monitor Function Enabled

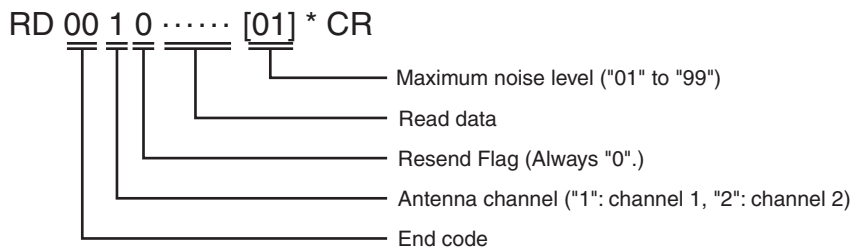

### ● Noise Monitor Function Disabled

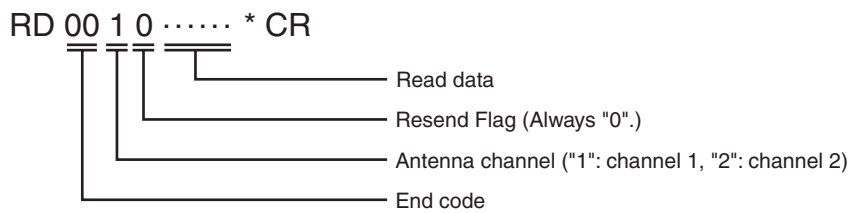

# SECTION 5

## Communications

☒ Tag Operation and Command Status	98
☒ V600-V680 Command Correspondence	101
☒ V680 Commands	103
☒ V600 Commands	172

# Tag Operation and Command Status

## Communications Control Protocol

The communications control procedure conforms to OMRON's SYSWAY protocol.

- (1) The first right to send is held by the host device, and it is transferred to the ID Controller after a command is sent.
- (2) When a response is returned from the ID Controller, the right to send is transferred back to the host device.
- (3) The right to send is transferred by using a carriage return (CR).
- (4) This protocol supports both 1:1 protocol and 1:N protocol.
- (5) The 1:N protocol features one host device connected to more than one ID Controller (32 maximum). A Controller number is added to the end of each command and response to identify the ID Controllers. FCS (Frame Check Sequence) and horizontal parity are used to provide strict error detection.
- (6) The 1:1 protocol features one host device connected to one ID Controller. To simplify the protocol, horizontal parity is not used.
- (7) The 1:N protocol can be specified even with a 1:1 connection (i.e., N = 1) to add a horizontal parity check.

### Explanation

1. The host device sends a command to the ID Controller.
2. The ID Controller analyzes the command from the host device, transmits the command, and writes data to or reads data from the memory in the Tag.
3. For read commands, the read data and response are sent to the host device. For write commands, a response indicating that processing is completed is sent to the host device.

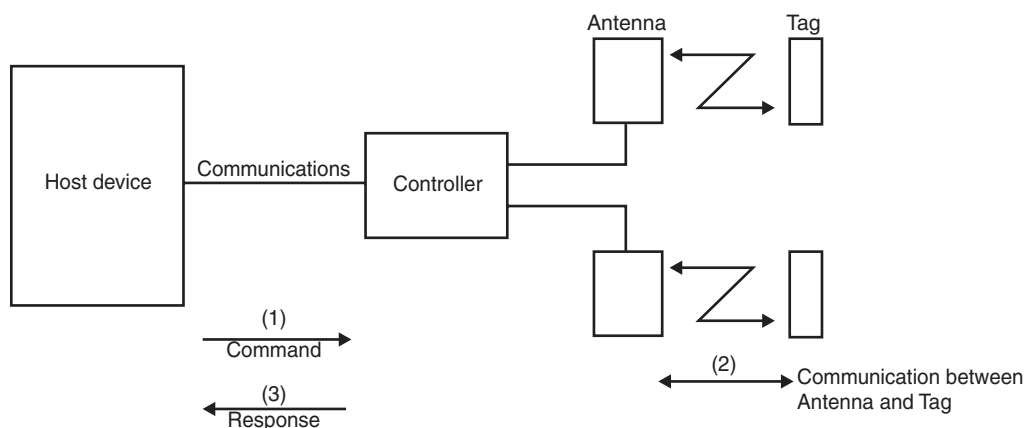

## Command Receiving Status

The status of the ID Controller for commands from the host device is described in this section

### ■ Command Standby Status

No command processing is being performed in this status and ID Controller commands can be received.

### ■ Processing Command Status

This status exists from the time from when a READ, WRITE, AUTO READ, or AUTO WRITE command is received until a response indicating that command processing has been completed is returned. When using V680 commands, commands can be sent to the other Antenna while a command is being executed. When using V600 commands, commands cannot be sent to the other Antenna while a command is being executed.

### ■ Polling Auto Subcommand Standby Status

This status exists from the time when a POLLING AUTO command until the following times:

- 1.Until processing with the Tag is ended, and the processing results are returned as the response to a command to request polling processing results.
- 2.Until polling processing is aborted with a command.

In this status, only a POLLING subcommand (REQUEST or ABORT), an ABORT command, or a host command can be received for the same Antenna.



When a response is being returned from the ID Controller to the host device, the ID Controller cannot correctly receive commands from the host device. Do not send commands while a response is being returned.

## Data Code Designation

Data to be read or written is specified in the command to be handled as either ASCII (JIS8 code) character data or as hexadecimal data.

### ■ ASCII (JIS8 Code) Designation

- Each data character is allocated 1 byte (1 address) of Tag memory and stored as ASCII (JIS8 code).

#### • Tag

Address			
0010	4	F	"O"
0011	4	D	"M"
0012	5	2	"R"
0013	4	F	"O"
0014	4	E	"N"

← 1 byte →

#### • ASCII Designation Example Using 1:1 Protocol

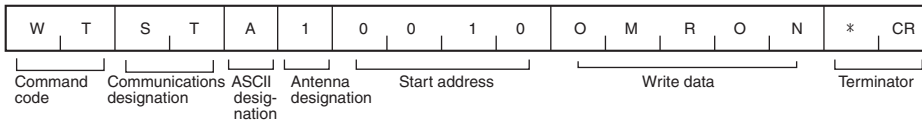

#### • ASCII Designation Example Using 1:N Protocol

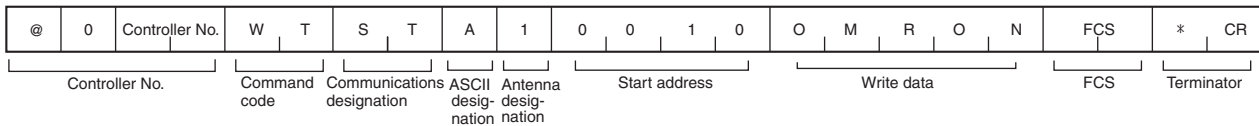

### ■ Hexadecimal Designation

- Each character is handled as hexadecimal data. Therefore, only characters 0 to F can be received.
- Each two characters of data is stored as is in 1 byte (1 address) of Tag memory. Therefore, always set two-character units (i.e., an even number of characters) for write commands. A command error will occur if an odd number of characters is mistakenly set.

#### • Tag

Address			
0010	1	9	
0011	9	6	

← 1 byte →

#### • Hexadecimal Designation Example Using 1:1 Protocol

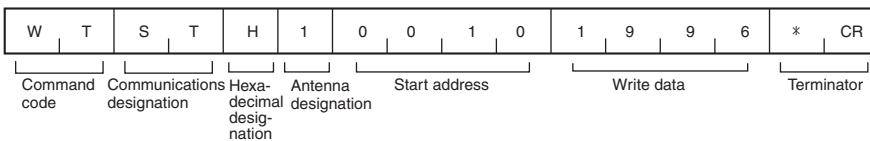

#### • Hexadecimal Designation Example Using 1:N Protocol

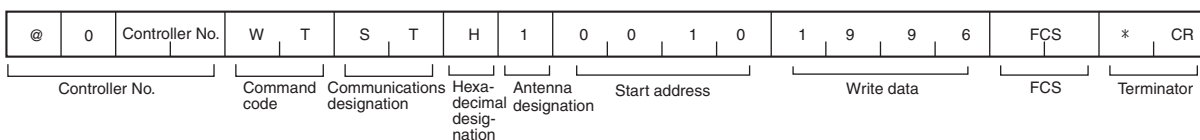

## V600-V680 Command Correspondence

Either V680 or V600 commands can be used for the V680-series ID Controllers. V600 commands can be used in applications in which V600-series ID Controllers were previously used so that the application does not have to be changed. V680 command can be used to take advantage of newly implemented functions.

The command series that is being used is specified on pin 10 of DIP switch SW3. V680 and V600 commands corresponds as shown in the following tables.

### Commands for Tag Communications

V680 Commands				V600 Commands		
Name	Com- mand code	Commu- nications designa- tion	Data designa- tion	Name	Com- mand code	Data designa- tion
READ	RD	ST	A/H	READ	RD	A/H
		ST	A/H	EXPANSION READ	XR	A/H
		SA	A/H	AUTO READ	AR	A/H
		PA	A/H	POLLING AUTO READ	PR	A/H
WRITE	WT	ST	A/H	WRITE	WT	A/H
		ST	A/H	EXPANSION WRITE	XW	A/H
		SA	A/H	AUTO WRITE	AW	A/H
		PA	A/H	POLLING AUTO WRITE	PW	A/H
DATA FILL	DF	ST	A/H	DATA FILL	DF	A/H
		SA	A/H	AUTO DATA FILL	AF	A/H
DATA CHECK	MD	ST	C/K	DATA CHECK	MD	C/K
OVERWRITE COUNT CONTROL	MD	ST	S/L	OVERWRITE COUNT CONTROL	MD	S/L
WRITE REPEAT	RP	-	-	WRITE REPEAT	RP	-
COPY	CP	ST	H	COPY	CP	H
AUTO COPY	AP	ST	H	AUTO COPY	AP	H
LARGE READ	ER	ST	A/H	LARGE READ	ER	A/H
READ TAG MEMORY ERROR CORRECTION	QR	ST	A/H	-	-	-
WRITE TAG MEMORY ERROR CORRECTION	QW	ST	A/H	-	-	-

### Communications Subcommands

V680 Commands			V600 Commands		
Name	Com- mand code	Data designa- tion	Name	Com- mand code	Data designa- tion
POLLING QUERY	PC	C/E	POLLING QUERY	PR	C/E
				PW	C/E
COMMAND PROCESSING TERMINATE	AA	-	COMMAND PROCESSING TERMINATE	AA	-
ABORT	XZ	-	ABORT	XZ	-

## Controller Control Commands

V680 Commands		V600 Commands	
Name	Com- mand code	Name	Com- mand code
COMMUNICATIONS SET	TR	COMMUNICATIONS SET	TR
PARAMETER SET	SP	PARAMETER SET	SP
OPERATION MODE CHANGE	MO	-	-
OPERATION CONDITION SET	SE	-	-
RESPONSE RESEND	RR	-	-
CONTROLLER CONTROL	CC	CONTROLLER CONTROL	CC
READ ERROR INFORMATION	CF	READ ERROR INFORMATION	CF
READ HISTORY INFORMATION	HI	-	-

## Host Commands

V680 Commands		V600 Commands	
Name	Com- mand code	Name	Com- mand code
TEST	TS	TEST	TS
VERSION READ	VS	VERSION READ	VS

## Evaluation Commands

V680 Commands		V600 Commands	
Name	Com- mand code	Name	Com- mand code
NOISE DETECTION	NS	-	-



## V680 Commands

### Communications Designation Function

Communications with the Tag are performed according to the communications designation listed in the following table.

Name	Symbol	Description
Single trigger	ST	When the ID Controller receives a command, it communicates with the Tag and then returns a response.
Single auto	SA	When the ID Controller receives a command, it waits to detect a Tag in the Antenna's communication area. When the ID Controller detects a Tag, it communicates with the Tag and then returns a response.
Single input trigger	SI	When the ID Controller receives a command, it communicates with the Tag on the rising edge of the TRG external input and then returns a response.
Repeat auto	RA	The ID Controller repeats the operation for a single auto designation (SA) as Tags enter the Antenna's communications area. The ID Controller communicates with each Tag in the communications area only once even if the Tag remains in the area.
Repeat input trigger	RI	The ID Controller repeats the operation for a single input trigger designation (SI).
Polling auto	PA	The ID Controller performs the operation for a single auto designation (SA) and then returns a response when it receives a POLLING QUERY (PC) command.
Polling input trigger	PI	The ID Controller performs the operation for a single input trigger designation (SI) and then returns a response when it receives a POLLING QUERY (PC) command.
FIFO trigger (See note.)	FT	When the ID Controller receives a command, it returns a response. After communicating, all further operations with that Tag are prohibited. The ID Controller communicates with only one operable Tag in the communications area. If a Tag that has operated for a single trigger designation (ST) is within the communications area, the ID Controller will not communicate with it a second time.
FIFO repeat (See note.)	FR	When the ID Controller receives a command, it waits until a Tag is detected within the Antenna's communications area, then returns a response. After communicating, all further operations with that Tag are prohibited. After returning the response, the ID Controller again waits for a Tag to approach it, and continues until the COMMAND PROCESSING TERMINATE (AA) command is received. The ID Controller communicates with only one operable Tag in the communications area.
Multi-access trigger (See note.)	MT	When the ID Controller receives a command, it communicates with all Tags in the communications area, then it returns a response after it has communicated with them all. After communicating, all further operations with that Tag are prohibited.
Multi-access repeat (See note.)	MR	When the ID Controller receives a command, it waits for a Tag to approach it. It communicates with each Tag in the communications area, and returns a response. After communicating, all further operations with that Tag are prohibited. After returning the response, the ID Controller again waits for a Tag to approach it, and continues until the COMMAND PROCESSING TERMINATE (AA) command is received.
Selective (See note.)	SL	The ID Controller performs a single trigger designation (ST) operation, and communicates only with Tags having the UID that is designated by the command from among all of the Tags in the Antenna's communications area.

**Note:** These designations cannot be used for communications with the V680-D1KP□□.

■ **Single Trigger Communications Designation (ST)**

With a Single trigger communications designation (ST), the ID Controller communicates with the Tag when the command is received from the host device. When the ID Controller has completed communicating with the Tag, it sends a response to the host device and then waits for another command. If there is no Tag in the communications error when the ID Controller receives the command from the host device, the ID Controller returns a Tag missing error (error code: 72). Use a sensor or other means to confirm the presence of a Tag before sending the command.

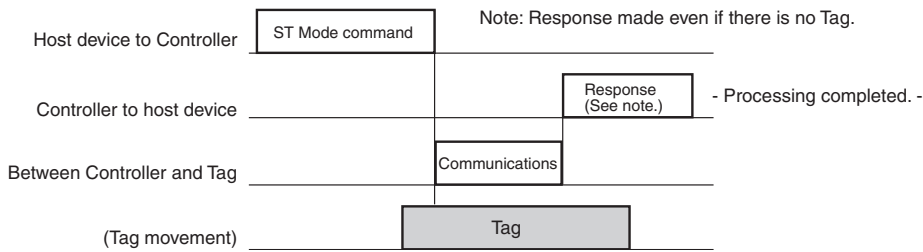
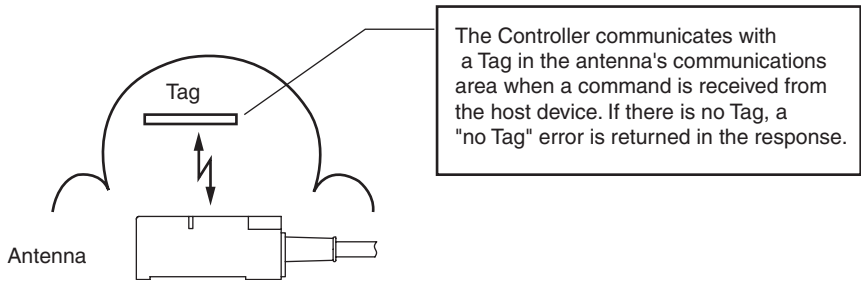

■ Auto Communications Designations (SA, RA, and PA)

With an auto communications designation, the ID Controller communicates with Tags that are automatically detected. When the ID Controller receives the command from the host device, it automatically detects and communicated with any Tag that enters the Antenna's communications area.

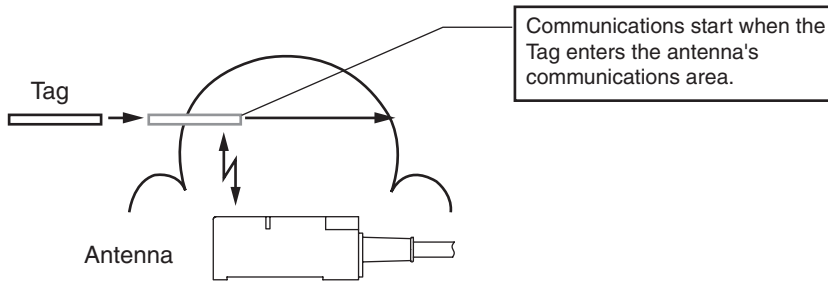

■ Single Auto Designation (SA)

With a single auto designation, the ID Controller communicates with the Tag, returns a response to the host device, and then enters command standby status.

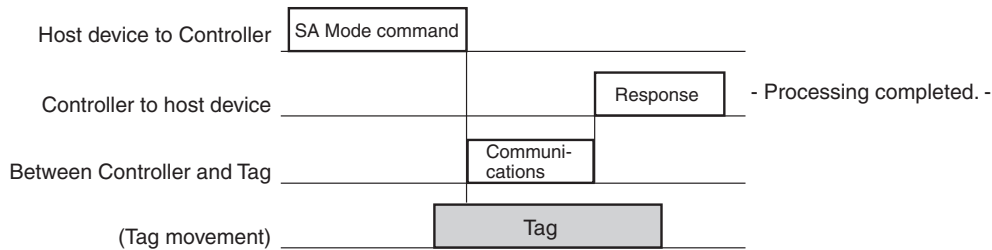

■ Repeat Auto Designation (RA)

A repeat auto designation causes the ID Controller to repeat the operation for a single auto designation (SA). Once the ID Controller has communicated with a Tag, it will not communicate again with the same Tag until the Tag leaves the Antenna's communications area. The COMMAND PROCESSING TERMINATE command (AA) is used to cancel processing.

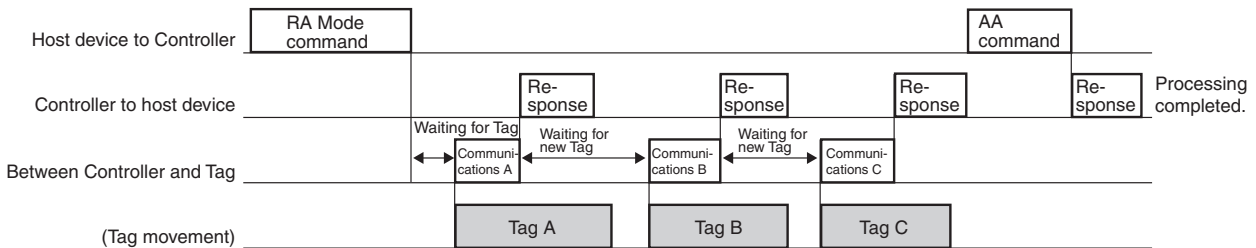

▪ **Polling Auto Designation (PA)**

A polling auto designation causes the ID Controller to return a response indicating reception of a polling command and then perform the operation for a single auto designation (SA). The ID Controller does not return a response until it receives the POLLING QUERY command (PC) (see note 1). The POLLING QUERY command (PC) (see note 2) is also used to cancel processing.

**Note 1.** A process designation of C is used to request the response.

**2.** A process designation of E is used to cancel polling.

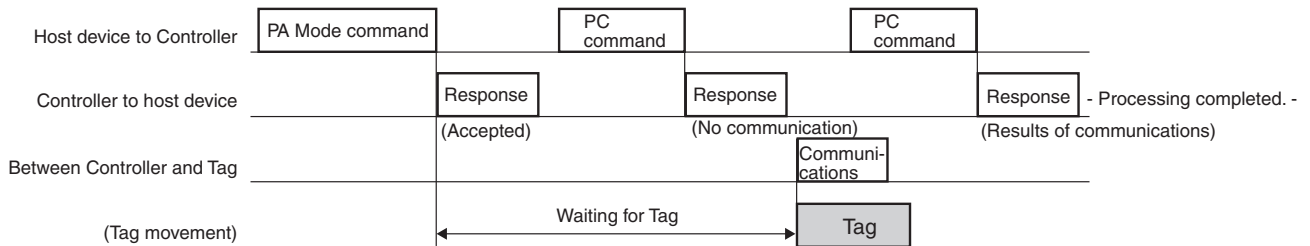

■ External Trigger Communications Designations (SI, RI, and PI)

The ID Controller communicates with a Tag on the rising edge of the TRG external input signal. These designations can be used to accurately perform communications even on high-speed lines because communications can be directly controlled with the output of a sensor that detects when Tags are in the Antenna's communications area.

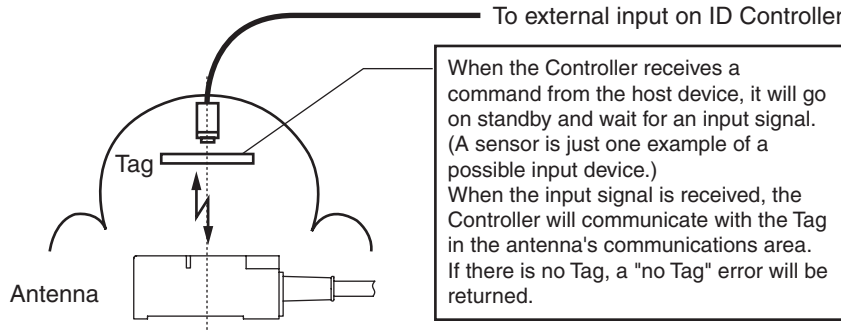

■ Single Input Trigger Designation (SI)

With a single input trigger designation, processing is ended when the ID Controller has completed communicating with the Tag.

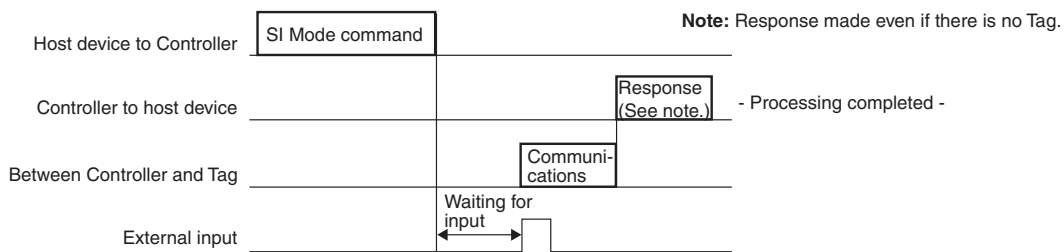

■ Repeat Input Trigger Designation (RI)

A repeat input trigger designation causes the ID Controller to repeat the operation for a single input trigger designation (SI). The ID Controller communicates with a Tag each time it detects the rising edge or the TRG external input signal. The COMMAND PROCESSING TERMINATE command (AA) is used to cancel processing.

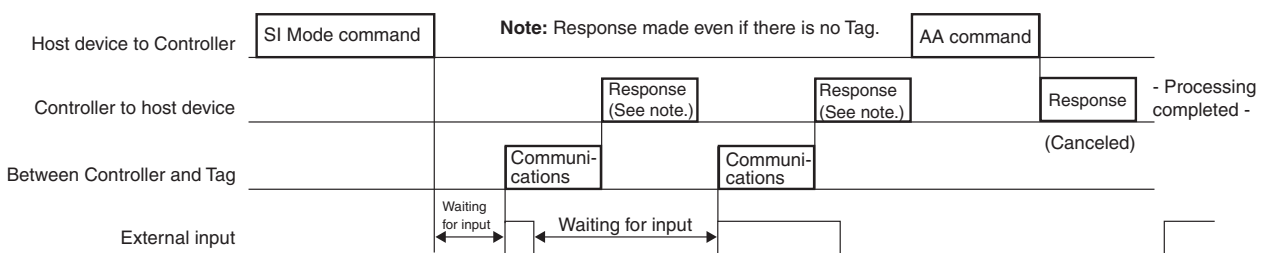

▪ **Polling Input Trigger Designation (PI)**

A polling auto designation causes the ID Controller to return a response indicating reception of a polling command and then perform the operation for a single input trigger designation (SI). The ID Controller does not return a response until it receives the POLLING QUERY command (PC) (see note 1). The POLLING QUERY command (PC) (see note 2) is also used to cancel processing.

**Note 1.** A process designation of C is used to request the response.

**2.** A process designation of E is used to cancel polling.

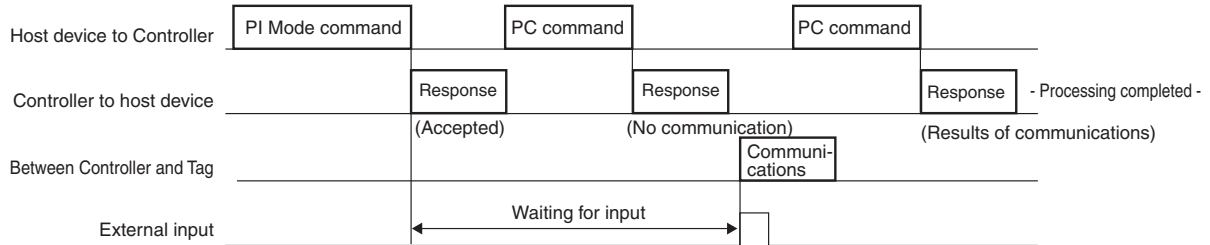

■ FIFO Communications Designations (FT/FR)

The ID Controller communicates in turn with each of the Tags entering the Antenna's communications area. Because all further processing with the Tag is prohibited after communicating, the ID Controller can only communicate with each new Tag that enters the Antenna's communications area.

If two or more Tags enter the Antenna's communications area at the same time, an error will result.

If a Tag whose access is prohibited leaves the Antenna's communications area, it becomes once again capable of communicating.

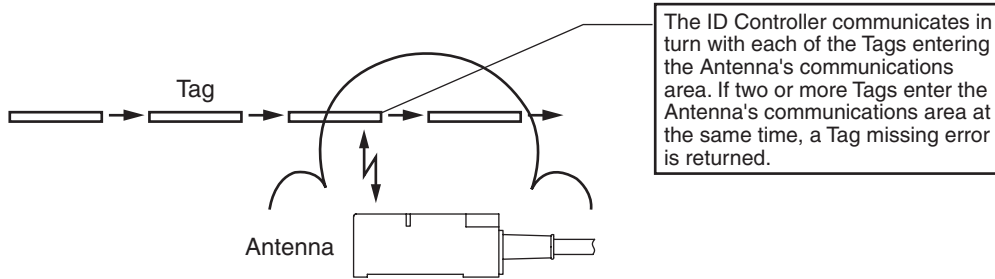

■ FIFO Trigger Designation (FT)

After communicating with a Tag, access to that Tag is prohibited and the ID Controller sends a response to the host device and then waits for another command.

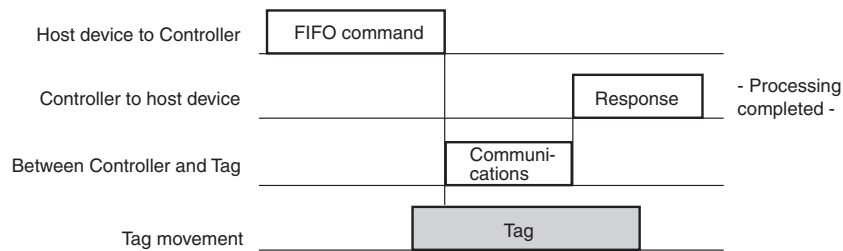

■ FIFO Repeat Designation (FR)

The operation of the FIFO trigger designation (FT) is repeated.

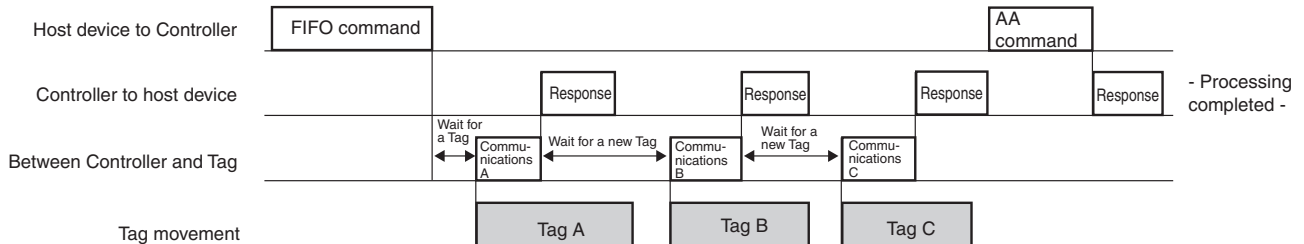

**Note:** FIFO communications designations (FT/FR) cannot be used for communicating with V680-D1KP□□ Tags.

■ Multi-access Communications Designations (MT/MR)

The ID Controller communicates with all Tags inside the Antenna's communications area.

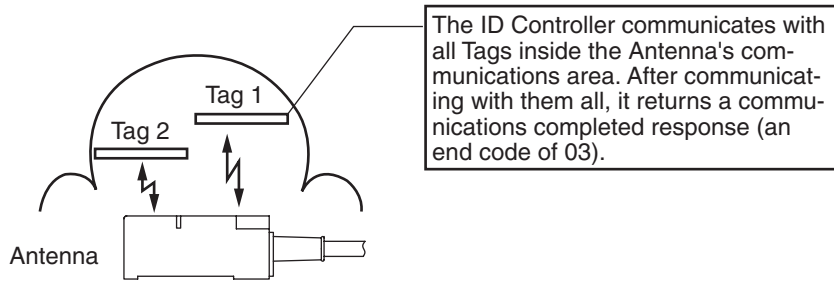

■ Multi-access Trigger Designation (MT)

Processing ends when the ID Controller has finished communicating with the Tags.

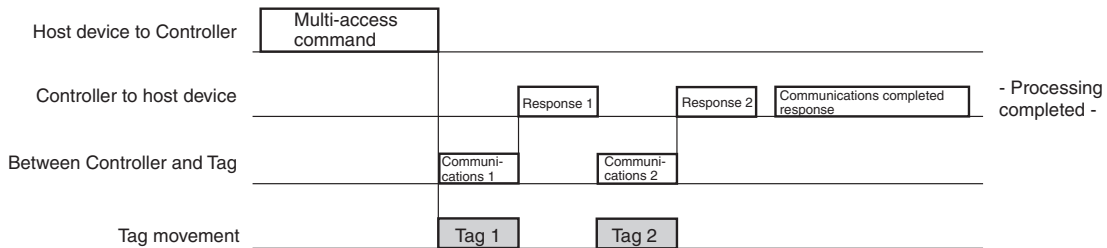

■ Multi-access Repeat Designation (MR)

The operation of the multi-access trigger designation (MT) is repeated.

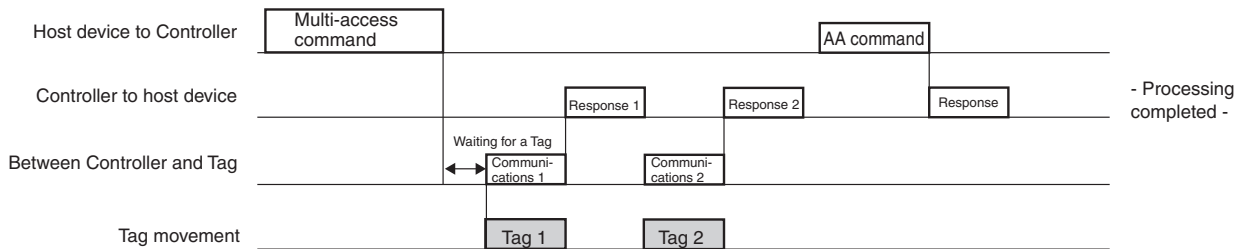

**Note:** Multi-access communications designations (MT/MR) cannot be used for communicating with V680-D1KP□□ Tags.

■ Selective Communications Designation (SL)

The ID Controller communicates only with Tags having the UID that is designated by the command from among all of the Tags in the Antenna's communications area.

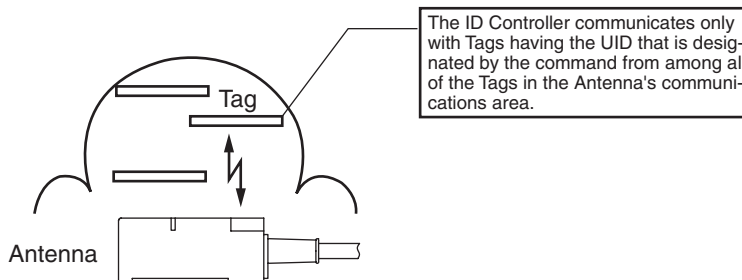

**Note:** The selective communications designation (SL) cannot be used for communicating with V680-D1KP□□ Tags.



## Command and Response Formats

This section describes the formats of the commands sent from the host device to the ID Controller and the responses returned by the ID Controller to the host device.

### Command Frame

#### 1:1 Protocol



#### 1:N Protocol

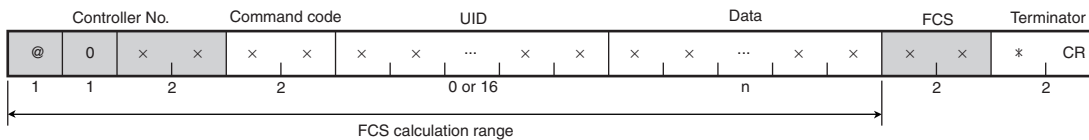

CHECK!

The shaded portion is added for the 1:N protocol.  
The Controller No. is given as a decimal number between 00 and 31.

Name	Description
Controller No.	When using 1:N protocol, the Controller number (00 to 31) is added after the @ mark and the 0. (In decimal)
Command code	A code that specifies the command to be executed.
UID	A unique identifier used to identify Tags.
Data	Data that specifies parameters for command execution (e.g., addresses or number of bytes), write data, etc.
FCS	Horizontal parity check data that is added when using 1:N protocol.
Terminator	Indicates the end of the command.

■ Response Frame

■ 1:1 Protocol

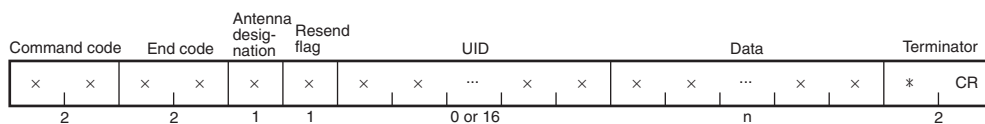

■ 1:N Protocol

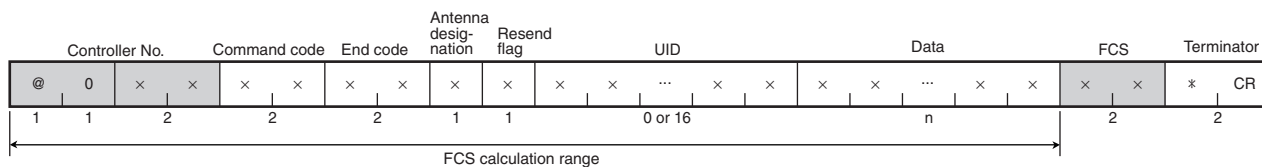

Name	Description
Command code	For all commands other than an RP or PC command, the data that is in the transmitted command frame is added and returned.
End code	Indicates the execution result for the command. Refer to <i>List of End Codes</i> for information on end codes. p. 171
Antenna designation	Indicates the number of the Antenna used for communications. "1": Antenna 1 "2": Antenna 2
Resend flag	A flag indicating the response for resends. "0": Response after normal command processing "1": Response returned for a RESPONSE RESEND (RR) command.
Data	The result of executing the command and the obtained data (for example, the read data).
FCS	Horizontal parity check data that is added when using 1:N protocol.

**Note:** Other than the above items, the same data as the command frame is returned in the response.

## List of Commands

Commands can be classified into five major types.

### ■ Commands for Tag Communications

The following commands are used to communicate with Tags.

Command code	Name	Process designation	Description	Page
RD	READ	A/H	Reads up to 2 KB of data from a Tag.	p. 116
WT	WRITE	A/H	Writes up to 2 KB of data to the memory of a Tag.	p. 118
DF	DATA FILL	A/H	Writes the specified data to the specified number of bytes beginning from the specified start address.	p. 120
MD	DATA CHECK	C/K	Checks the memory check code in the Tag.	p. 125
	OVERWRITE COUNT CONTROL	S/L	Used to manage the number of times data is written to a Tag.	p. 123
RP	WRITE REPEAT	-	Executes the most recently executed write command again.	p. 127
ID	READ ID	H	Reads the Tag's ID code.	p. 128
CP	COPY	H	Reads data from the memory of a Tag using one Antenna and writes it to the memory of the Tag in the other Antenna's communications area.	p. 129
AP	AUTO COPY	H	Waits for Tags to approach and then reads data from the memory of a Tag using one Antenna and writes it to the memory of the Tag in the other Antenna's communications area.	p. 131
ER	LARGE READ	A/H	Reads up to 8 KB of data from a Tag.	p. 133
QR	READ TAG MEMORY ERROR CORRECTION	A/H	Reads data from the memory of a Tag. Also checks the memory check code in the Tag to determine the accuracy of the data.	p. 136
QW	WRITE TAG MEMORY ERROR CORRECTION	A/H	Writes data to the memory of the Tag. Also writes the memory check code for the data reliability inspection to the memory of the Tag.	p. 138

### ■ Communications Subcommands

The following commands are used to cancel command execution.

Command code	Name	Process designation	Description	Page
PC	POLLING QUERY	C/E	Queries or cancels polling processing.	p. 140
AA	COMMAND PROCESSING TERMINATE	-	Forcefully ends communications with a Tag.	p. 142
XZ	ABORT	-	Resets the ID Controller to the status entered immediately after turning ON the power supply. The ID Controller does not send a response. Do not use the ABORT command while the ID Controller is communicating with a Tag.	p. 143

■ **Controller Control Commands**

The controller control commands are used to set communication parameters or when resending the response.

Command code	Name	Description	Page
US	UID ADDITION SET	Sets whether or not UID should be added to the read command (RD) response.	p. 144
TR	COMMUNICATIONS SET	Sets serial communications parameters for communicating with the host device.	p. 145
SP	PARAMETER SET	Sets, reads, or initializes ID Controller parameters.	p. 147
MO	OPERATION MODE CHANGE	Changes the operation mode.	p. 151
SE	OPERATION CONDITION SET	Sets operation conditions for Self Execution Mode.	p. 153
RR	RESPONSE RESEND	Resends the last response that was sent.	p. 159
CC	CONTROLLER CONTROL	Controls or confirms ID Controller I/O.	p. 160
CF	READ ERROR INFORMATION	Reads the error log.	p. 162
HI	READ HISTORY INFORMATION	Reads the ID Controller's history information.	p. 164

■ **Host Commands**

The following commands are used to control the ID Controller.

Command code	Name	Description	Page
TS	TEST	Checks the communications conditions between the ID Controller and host device. The data sent by the host device is returned by the ID Controller without modification.	p. 166
VS	VERSION READ	Read the software version of the ID Controller.	p. 167

■ **Evaluation Command**

The following command is used to check ambient noise.

Command code	Name	Description	Page
NS	NOISE DETECTION	Measures noise under normal conditions. The ID Controller returns the noise level as the results of the measurement.	p. 168

## FCS Calculation Example

### Reading 5 Bytes Started from Address 0010<sub>H</sub>

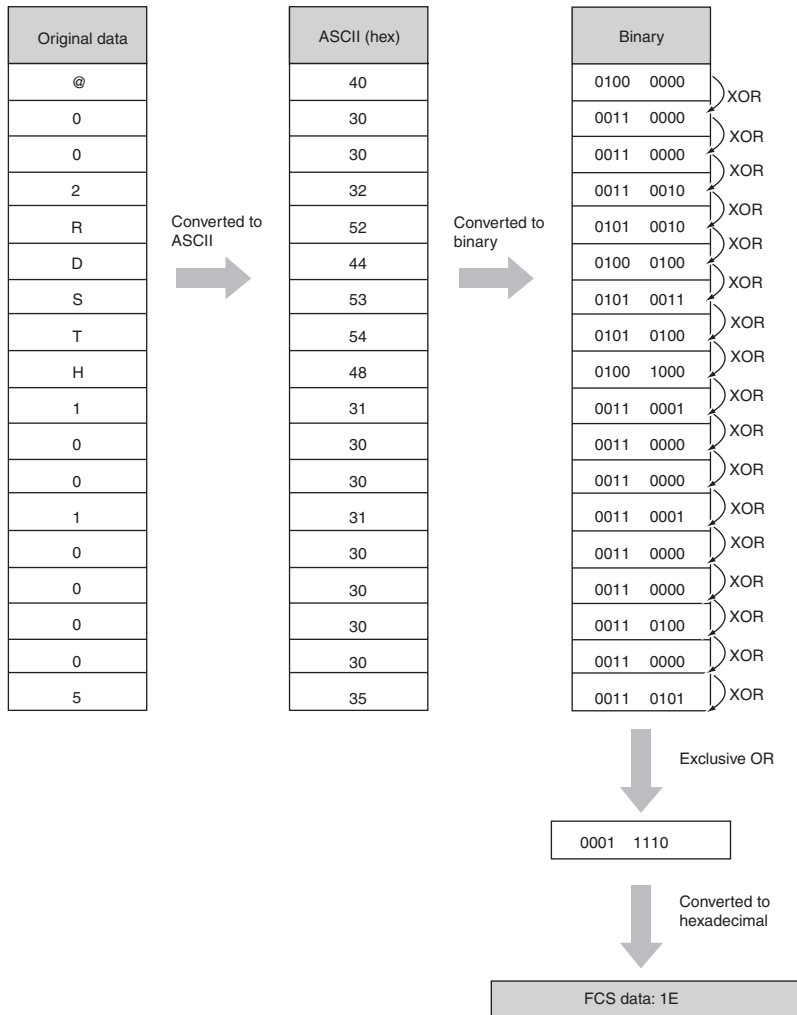
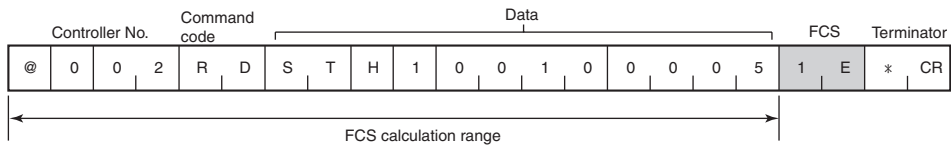

## Commands for Tag Communications

This section describes the commands that are used to communicate with Tags.

### ■ READ (RD)

The READ command reads up to 2 KB of data from a Tag.

#### ■ 1:1 Protocol

##### Command

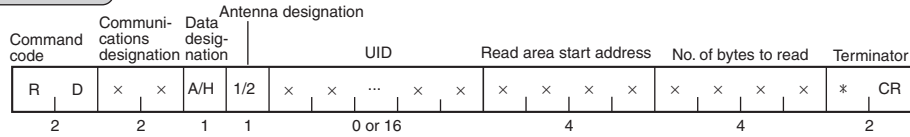

Communications designation	Specifies the method of communications with the Tag. Refer to <i>Communications Designation Function</i> for details on the communications designation.  p. 103
Data designation	Specifies the code format when sending the read data response. "A": ASCII "H": Hexadecimal
Antenna designation	Specifies the Antenna with which to communicate. "1": Antenna 1 "2": Antenna 2
UID	A unique identifier used to identify Tags. Added only for the selective communications designation (SL).
Read area start address	Specifies the start address of the area in the Tag from which data is to be read from in 4-digit hexadecimal. Setting range: 0000H to FFFFH
No. of bytes to read	Specifies the number of bytes to read from the Tag in 4-digit hexadecimal. Up to 2 KB can be read with one command. Setting range: 0001H to 0800H <ul style="list-style-type: none"> <li>• 1000 Byte Tags (V680-D1KP□□) <ul style="list-style-type: none"> <li>ASCII: 1000 bytes (1000 characters)</li> <li>Hexadecimal: 1000 bytes (2000 characters)</li> </ul> </li> <li>• 2000 Byte Tags (V680-D2KF□□) <ul style="list-style-type: none"> <li>ASCII: 2000 bytes (2000 characters)</li> <li>Hexadecimal: 2000 bytes (4000 characters)</li> </ul> </li> <li>• 8-/32-KB Tags (V680-D8KF68/-D32KF68) <ul style="list-style-type: none"> <li>ASCII: 2048 bytes (2048 characters)</li> <li>Hexadecimal: 2048 bytes (4096 characters)</li> </ul> </li> </ul>

##### Response

#### Communications Designation Other Than PA or PI

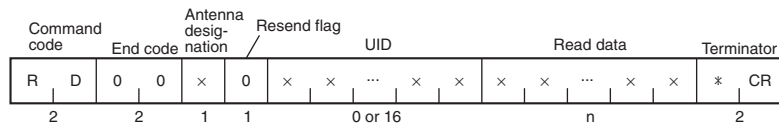

#### Communications Designation of PA or PI

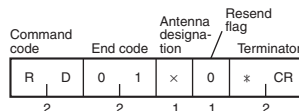

UID	A unique identifier used to identify Tags. Added in the following cases: <ul style="list-style-type: none"> <li>• Added when the ADD UID (US) command is set to add a UID.</li> <li>• Added for multi-access communications designations (MT/MR).</li> </ul>
Read data	The data read from the Tag. The number of characters will be the same as the specified number of bytes to read for ASCII data and twice that number for hexadecimal data.

1:N Protocol

Command



Communications designation	Specifies the method of communications with the Tag. Refer to <i>Communications Designation Function</i> for details on the communications designation.  p. 103
Data designation	Specifies the code format when sending the read data response. "A": ASCII "H": Hexadecimal
Antenna designation	Specifies the Antenna with which to communicate. "1": Antenna 1 "2": Antenna 2
UID	A unique identifier used to identify Tags. Added only for the selective communications designation (SL).
Read area start address	Specifies the start address of the area in the Tag from which data is to be read from in 4-digit hexadecimal. Setting range: 0000H to FFFFH
No. of bytes to read	Specifies the number of bytes to read from the Tag in 4-digit hexadecimal. Up to 2 KB can be read with one command. Setting range: 0001H to 0800H <ul style="list-style-type: none"> <li>• 1000 Byte Tags (V680-D1KP□□) <ul style="list-style-type: none"> <li>ASCII: 1000 bytes (1000 characters)</li> <li>Hexadecimal: 1000 bytes (2000 characters)</li> </ul> </li> <li>• 8-/32-KB Tags (V680-D8KF68/-D32KF68) <ul style="list-style-type: none"> <li>ASCII: 2048 bytes (2048 characters)</li> <li>Hexadecimal: 2048 bytes (4096 characters)</li> </ul> </li> <li>• 2000 Byte Tags (V680-D2KF□□) <ul style="list-style-type: none"> <li>ASCII: 2000 bytes (2000 characters)</li> <li>Hexadecimal: 2000 bytes (4000 characters)</li> </ul> </li> </ul>

SECTION 5  
V680 Commands

Response

Communications Designation Other Than PA or PI

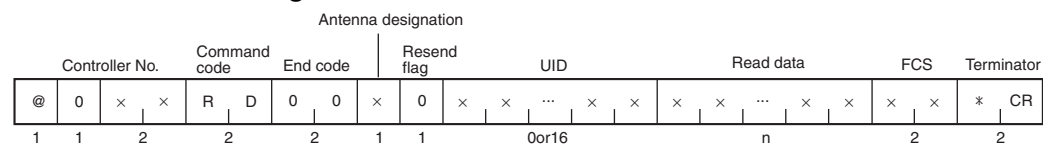

Communications Designation of PA or PI

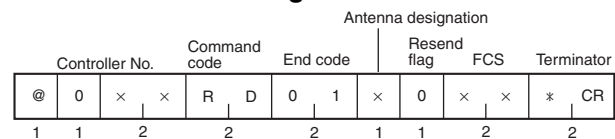

UID	A unique identifier used to identify Tags. Added in the following cases: <ul style="list-style-type: none"> <li>• Added when the ADD UID (US) command is set to add a UID.</li> <li>• Added for multi-access communications designations (MT/MR).</li> </ul>
Read data	The data read from the Tag. The number of characters will be the same as the specified number of bytes to read for ASCII data and twice that number for hexadecimal data.

■ WRITE (WT)

The WRITE command writes up to 2 KB of data to the memory of a Tag.

■ 1:1 Protocol

Command

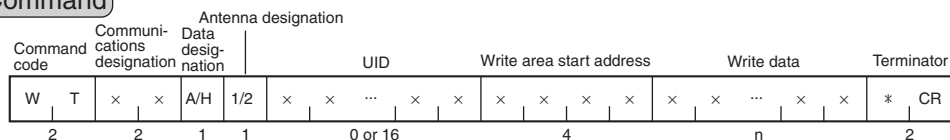

Communications designation	Specifies the method of communications with the Tag. Refer to <i>Communications Designation Function</i> for details on the communications designation. p. 103
Data designation	Specifies the code format when sending the Tag write data. “A”: ASCII “H”: Hexadecimal
Antenna designation	Specifies the Antenna with which to communicate. “1”: Antenna 1 “2”: Antenna 2
UID	A unique identifier used to identify Tags. Added only for the selective communications designation (SL).
Write area start address	Specifies the start address of the area in the Tag to which data is to be written in 4-digit hexadecimal. Setting range: 0000H to FFFFH
Write data	Specified the data to be written to the Tag. Up to 2 KB can be written with one command. <ul style="list-style-type: none"> <li>1000 Byte Tags (V680-D1KP□□) <ul style="list-style-type: none"> <li>ASCII: 1000 bytes (1000 characters)</li> <li>Hexadecimal: 1000 bytes (2000 characters)</li> </ul> </li> <li>8-/32-KB Tags (V680-D8KF68/-D32KF68) <ul style="list-style-type: none"> <li>ASCII: 2048 bytes (2048 characters)</li> <li>Hexadecimal: 2048 bytes (4096 characters)</li> </ul> </li> <li>2000 Byte Tags (V680-D2KF□□) <ul style="list-style-type: none"> <li>ASCII: 2000 bytes (2000 characters)</li> <li>Hexadecimal: 2000 bytes (4000 characters)</li> </ul> </li> </ul>

Response

Communications Designation Other Than PA or PI

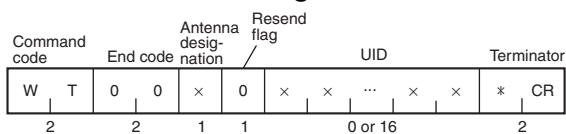

**Note:** When using the multi-access trigger communications designation (MT), the ID controller returns an end code of 03 after communicating with all Tags.

Communications Designation of PA or PI

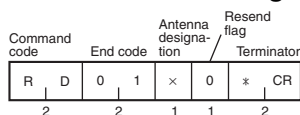

UID	A unique identifier used to identify Tags. Added only for multi-access communications designations (MT/MR).
-----	--



1:N Protocol

Command

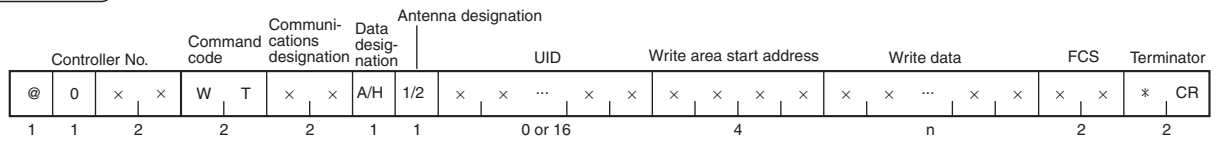

Communications designation	Specifies the method of communications with the Tag. Refer to <i>Communications Designation Function</i> for details on the communications designation. p. 103
Data designation	Specifies the code format when sending the Tag write data. "A": ASCII "H": Hexadecimal
Antenna designation	Specifies the Antenna with which to communicate. "1": Antenna 1 "2": Antenna 2
UID	A unique identifier used to identify Tags. Added only for the selective communications designation (SL).
Write area start address	Specifies the start address of the area in the Tag to which data is to be written in 4-digit hexadecimal. Setting range: 0000H to FFFFH
Write data	Specified the data to be written to the Tag. Up to 2 KB can be written with one command. <ul style="list-style-type: none"> <li>1000 Byte Tags (V680-D1KP□□) <ul style="list-style-type: none"> <li>ASCII: 1000 bytes (1000 characters)</li> <li>Hexadecimal: 1000 bytes (2000 characters)</li> </ul> </li> <li>8-/32-KB Tags (V680-D8KF68/-D32KF68) <ul style="list-style-type: none"> <li>ASCII: 2048 bytes (2048 characters)</li> <li>Hexadecimal: 2048 bytes (4096 characters)</li> </ul> </li> <li>2000 Byte Tags (V680-D2KF□□) <ul style="list-style-type: none"> <li>ASCII: 2000 bytes (2000 characters)</li> <li>Hexadecimal: 2000 bytes (4000 characters)</li> </ul> </li> </ul>

SECTION 5  
V680 Commands

Response

Communications Designation Other Than PA or PI

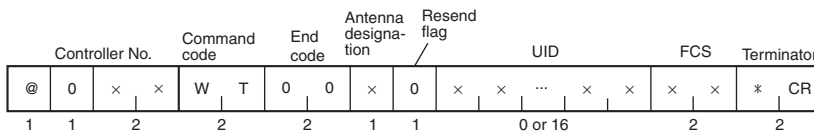

**Note:** When using the multi-access trigger communications designation (MT), the ID controller returns an end code of 03 after communicating with all Tags.

Communications Designation of PA or PI

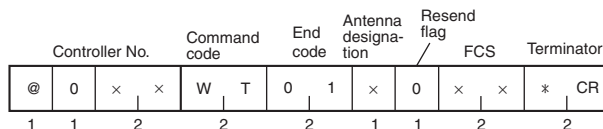

UID	A unique identifier used to identify Tags. Added only for multi-access communications designations (MT/MR).
-----	--

### DATA FILL (DF)

The DATA FILL command writes the designated data for the specified number of bytes beginning from the specified start address.



This command will write data even to areas of the Tag for which write protection has been set. Confirm that there is no important data in the area being written before executing this command.

### 1:1 Protocol

#### Command

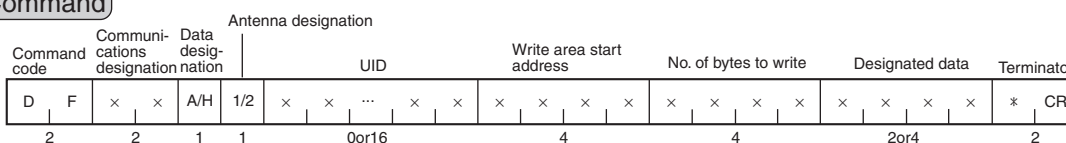

Communications designation	Specifies the method of communications with the Tag. Refer to <i>Communications Designation Function</i> for details on the communications designation. p. 103
Data designation	Specifies the code format when sending the Tag write data. "A": ASCII "H": Hexadecimal
Antenna designation	Specifies the Antenna with which to communicate. "1": Antenna 1 "2": Antenna 2
UID	A unique identifier used to identify Tags. Added only for the selective communications designation (SL).
Write area start address	Specifies the start address of the area in the Tag to which data is to be written in 4-digit hexadecimal. Setting range: 0000H to FFFFH
No. of bytes to write	Specifies the number of bytes of data to write to the Tag in 4-digit hexadecimal. Setting range: 000H, 0001H to 0800H (When 0000H is specified: Writes up to the end address.)
Designated data	Specified the data to be written to the Tag. • ASCII: 2 digits specified. • Hexadecimal: 4 digits specified.

#### Response

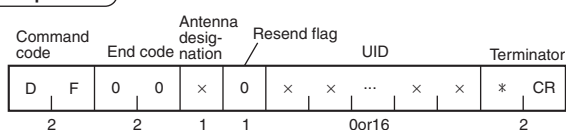

**Note:** When using the multi-access trigger communications designation (MT), the ID controller returns an end code of 03 after communicating with all Tags.

UID	A unique identifier used to identify Tags. Added only for multi-access communications designations (MT/MR).
-----	--

**Example**

In this example, 0101H is written to Tag memory for 0006H bytes starting from address 0030H using Antenna 1. The communications designation is “ST”.

**Command**

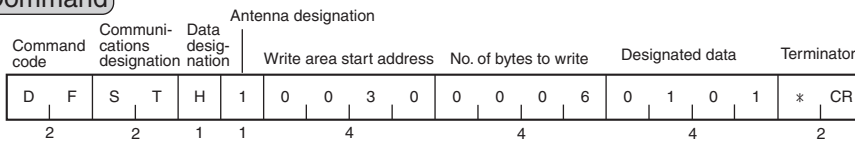

**Response**

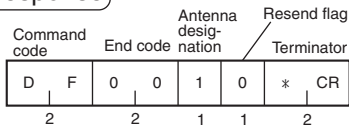

Before Writing

002FH	2	F
0030H	3	0
0031H	3	1
0032H	3	2
0033H	3	3
0034H	3	4
0035H	3	5
0036H	3	6

After Writing

002FH	2	F
0030H	0	1
0031H	0	1
0032H	0	1
0033H	0	1
0034H	0	1
0035H	0	1
0036H	3	6

1:N Protocol

Command

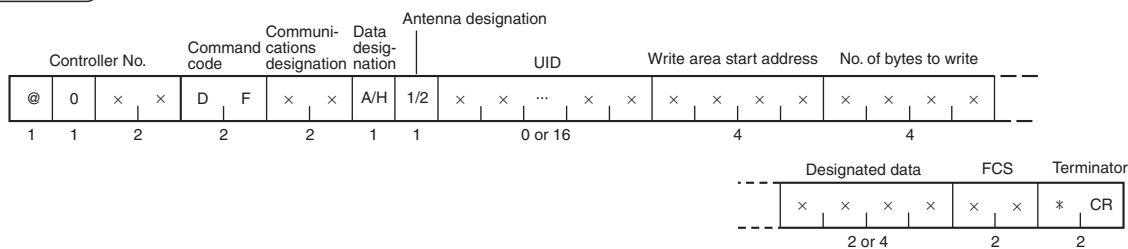

Communications designation	Specifies the method of communications with the Tag. Refer to <i>Communications Designation Function</i> for details on the communications designation. p. 103
Data designation	Specifies the code format when sending the Tag write data. “A”: ASCII “H”: Hexadecimal
Antenna designation	Specifies the Antenna with which to communicate. “1”: Antenna 1 “2”: Antenna 2
UID	A unique identifier used to identify Tags. Added only for the selective communications designation (SL).
Write area start address	Specifies the start address of the area in the Tag to which data is to be written in 4-digit hexadecimal. Setting range: 0000H to FFFFH
No. of bytes to write	Specifies the number of bytes of data to write to the Tag in 4-digit hexadecimal. Setting range: 000H, 0001H to 0800H (When 0000H is specified: Writes up to the end address.)

Response

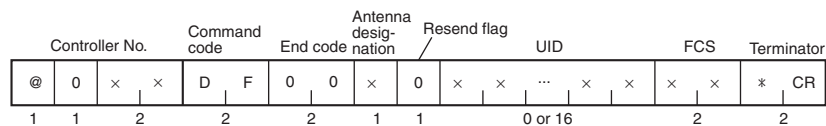

**Note:** When using the multi-access trigger communications designation (MT), the ID controller returns an end code of 03 after communicating with all Tags.

UID	A unique identifier used to identify Tags. Added only for multi-access communications designations (MT/MR).
-----	--



## OVERWRITE COUNT CONTROL (MD S/L)

The OVERWRITE COUNT CONTROL command is used to manage overwrite counts for EEPROM Tags. The specified overwrite count control area data is updated to enable determining when the EEPROM's write life has expired.

### 1:1 Protocol

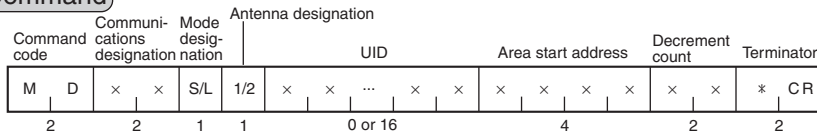
#### Command



Communications designation	Specifies the method of communications with the Tag. Refer to <i>Communications Designation Function</i> for details on the communications designation.  p. 103
Mode designation	Specifies the check process. “S”: Subtraction (Overwrite control count can be set by user.) (16,700,000 writes max.) (See note.) “L”: Addition (Overwrite control count fixed at 100,000 writes.)
Antenna designation	Specifies the Antenna with which to communicate. “1”: Antenna 1 “2”: Antenna 2
UID	A unique identifier used to identify Tags. Added only for the selective communications designation (SL).
Area start address	Specifies the start address of the overwrite count control area in 4-digit hexadecimal. Setting range: 0000H to FFFDH
Decrement count	Specifies the number of refresh operations in 2-digit hexadecimal. Setting range: 00H to FFH (00H: Performs overwrite count check only.)  Refer to <i>Tag Service Life Check</i> for details.  p. 91

**Note:** The write life for EEPROM Tags is 300,000 writes at 40°C.

#### Response

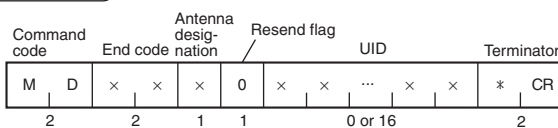



**Note:** When using the multi-access trigger communications designation (MT), the ID controller returns an end code of 03 after communicating with all Tags.

End code	Indicates the execution result for the command. 00: Normal end 76: Data error warning  Refer to <i>List of End Codes</i> for information on other end codes.  p. 171
UID	A unique identifier used to identify Tags. Added only for multi-access communications designations (MT/MR).

■ 1:N Protocol

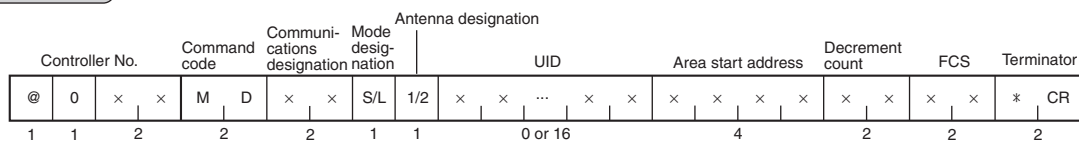
**Command**



Communications designation	Specifies the method of communications with the Tag. Refer to <i>Communications Designation Function</i> for details on the communications designation.  p. 103
Mode designation	Specifies the check process. “S”: Subtraction (Overwrite control count can be set by user.) (16,700,000 writes max.) (See note.) “L”: Addition (Overwrite control count fixed at 100,000 writes.)
Antenna designation	Specifies the Antenna with which to communicate. “1”: Antenna 1 “2”: Antenna 2
UID	A unique identifier used to identify Tags. Added only for the selective communications designation (SL).
Area start address	Specifies the start address of the overwrite count control area in 4-digit hexadecimal. Setting range: 0000H to FFFDH
Decrement count	Specifies the number of refresh operations in 2-digit hexadecimal. Setting range: 00H to FFH (00H: Performs overwrite count check only.)  Refer to <i>Tag Service Life Check</i> for details.  p. 91

**Note:** The write life for EEPROM Tags is 300,000 writes at 40°C.

**Response**

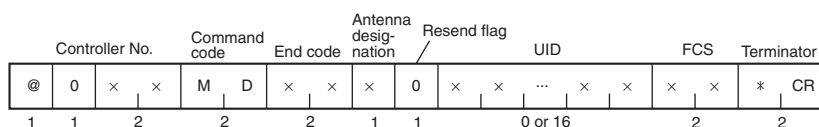

**Note:** When using the multi-access trigger communications designation (MT), the ID controller returns an end code of 03 after communicating with all Tags.

End code	Indicates the execution result for the command. 00: Normal end 76: Data error warning  Refer to List of End Codes for information on other end codes.  p. 171
UID	A unique identifier used to identify Tags. Added only for multi-access communications designations (MT/MR).



## ■ DATA CHECK (MD C/K)

The DATA CHECK command is used to write or verify the CRC code in the specified check block. The CRC code is generated using the following polynomial  $X^{16} + X^{12} + X^5 + 1$ .

### ■ 1:1 Protocol

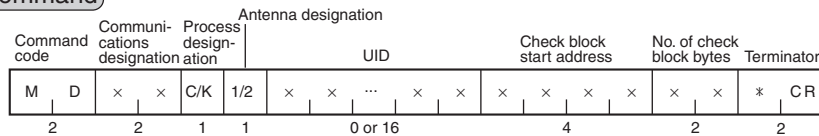
#### Command



Communications designation	Specifies the method of communications with the Tag. Refer to <i>Communications Designation Function</i> for details on the communications designation.  p. 103
Process designation	Specifies the check process. “C”: Check code verification “K”: Check code calculation
Antenna designation	Specifies the Antenna with which to communicate. “1”: Antenna 1 “2”: Antenna 2
UID	A unique identifier used to identify Tags. Added only for the selective communications designation (SL).
Check block start address	Specifies the start address of the check block in 4-digit hexadecimal. Setting range: 0000H to FFFDH
No. of check block bytes	Specifies the number of bytes in the check block in 2-digit hexadecimal. Setting range: 00H, 03H to FFH (Specify 00H for 256 bytes.)  Specify the number of bytes in the check code calculation area plus two for the number of check block bytes. Refer to <i>Tag Memory Error Correction</i> for details.  p. 94

#### Response

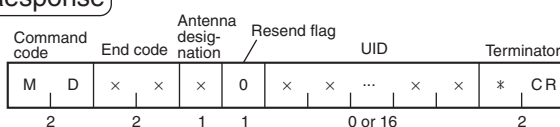

**Note:** When using the multi-access trigger communications designation (MT), the ID controller returns an end code of 03 after communicating with all Tags.

End code	Indicates the execution result for the command. 00: Normal end, Data normal (only when verification is performed) 76: Data error warning (only when verification is performed)  Refer to <i>List of End Codes</i> for information on other end codes.  p. 171
UID	A unique identifier used to identify Tags. Added only for multi-access communications designations (MT/MR).





Refer to *Tag Memory Error Correction* for details on memory checks.

CHECK!  p. 94

▪ **1:N Protocol**

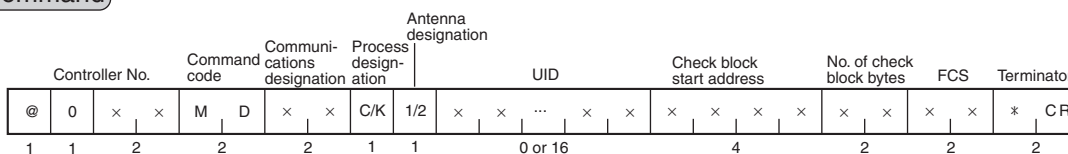
**Command**



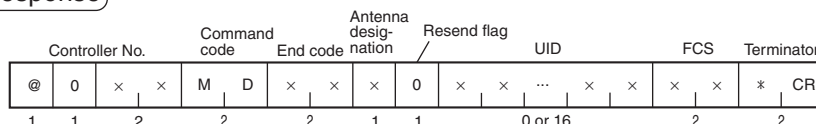

Communications designation	Specifies the method of communications with the Tag. Refer to <i>Communications Designation Function</i> for details on the communications designation.  p. 103
Process designation	Specifies the check process. “C”: Check code verification “K”: Check code calculation
Antenna designation	Specifies the Antenna with which to communicate. “1”: Antenna 1 “2”: Antenna 2
UID	A unique identifier used to identify Tags. Added only for the selective communications designation (SL).
Check block start address	Specifies the start address of the check block in 4-digit hexadecimal. Setting range: 0000H to FFFDH
No. of check block bytes	Specifies the number of bytes in the check block in 2-digit hexadecimal. Setting range: 00H, 03H to FFH (Specify 00H for 256 bytes.)  Specify the number of bytes in the check code calculation area plus two for the number of check block bytes. Refer to <i>Tag Memory Error Correction</i> for details.  p. 94

**Response**



**Note:** When using the multi-access trigger communications designation (MT), the ID controller returns an end code of 03 after communicating with all Tags.

End code	Indicates the execution result for the command. 00: Normal end, Data normal (only when verification is performed) 76: Data error warning (only when verification is performed)  Refer to <i>List of End Codes</i> for information on other end codes.  p.171
UID	A unique identifier used to identify Tags. Added only for multi-access communications designations (MT/MR).

 Refer to *Tag Memory Error Correction* for details on memory checks.  
 p. 94



## ■ WRITE REPEAT (RP)

The WRITE REPEAT command is used to execute the most recently executed write command again.

### ■ 1:1 Protocol

#### Command

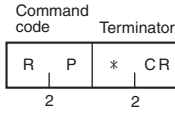

#### Response

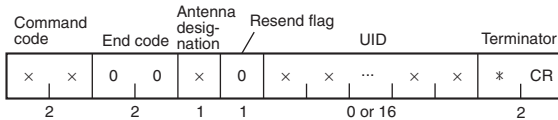

**Note:** When using the multi-access trigger communications designation (MT) for a previously executed write command, the ID controller returns an end code of 03 after communicating with all Tags.

Command code	The command code is the same as the last write command that was executed.
UID	A unique identifier used to identify Tags. Added only for multi-access communications designations (MT/MR) for a previously executed write command.



Write command information is cleared at the following time.

- When the ID Controller's power supply is reset.

If a WRITE REPEAT command is executed after write command information has been cleared, a command input error will occur.

### ■ 1:N Protocol

#### Command

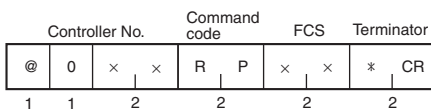

#### Response

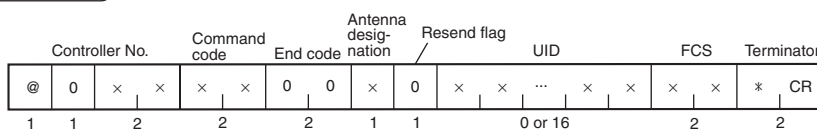

**Note:** When using the multi-access trigger communications designation (MT) for a previously executed write command, the ID controller returns an end code of 03 after communicating with all Tags.

Command code	The command code is the same as the last write command that was executed.
UID	A unique identifier used to identify Tags. Added only for multi-access communications designations (MT/MR) for a previously executed write command.



Write command information is cleared at the following time.

- When the ID Controller's power supply is reset.

If a WRITE REPEAT command is executed after write command information has been cleared, a command input error will occur.

■ READ ID

Reads the Tag's ID code.

■ 1:1 Protocol

Command

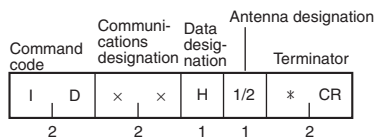

Communications designation	Specifies the method of communications with the Tag. The selective communications designation (SL) cannot be used. Refer to <i>Communications Designation Function</i> for details on the communications designation.  p. 103
Data designation	"H": This designation is fixed.
Antenna designation	Specifies the Antenna with which to communicate. "1": Antenna 1 "2": Antenna 2

Response

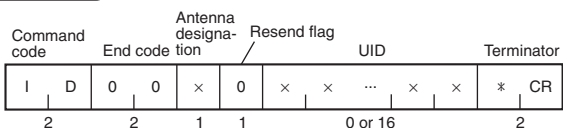

UID	A unique identifier used to identify Tags. <b>Note:</b> Not added when an error is generated.
-----	--

■ 1:N Protocol

Command

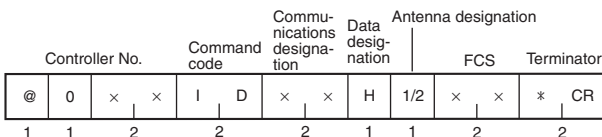

Communications designation	Specifies the method of communications with the Tag. The selective communications designation (SL) cannot be used. Refer to <i>Communications Designation Function</i> for details on the communications designation.  p. 103
Data designation	"H": This designation is fixed.
Antenna designation	Specifies the Antenna with which to communicate. "1": Antenna 1 "2": Antenna 2

Response

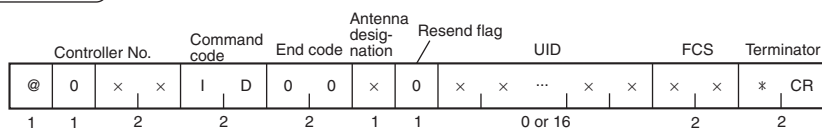

UID	A unique identifier used to identify Tags. <b>Note:</b> Not added when an error is generated.
-----	--



The ID code is written in the memory of the Tag and may be affected by data retention characteristics at high temperatures. Take suitable precautions when using the READ ID command for Tags operating at high temperatures.

## ■ COPY (CP)

The COPY command reads data from the memory of a Tag using one Antenna and writes it to the memory of the Tag in the other Antenna's communications area. This command cannot be used with the V680-CA5D01-V2.

### ■ 1:1 Protocol

#### Command

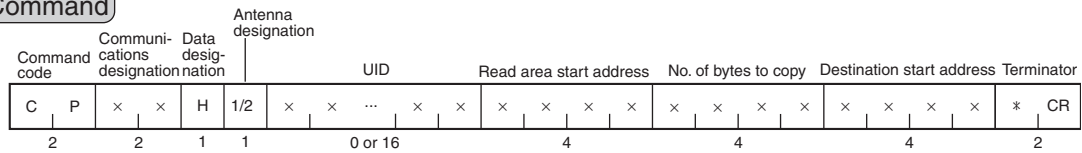

Communications designation	Specifies the method of communications with the Tag. Refer to <i>Communications Designation Function</i> for details on the communications designation.  p. 103
Data designation	Always "H".
Antenna designation	Specifies the Antenna with which to communicate. "1": Reads from Antenna 1 and writes to Antenna 2. "2": Reads from Antenna 2 and writes to Antenna 1.
UID	A unique identifier used to identify Tags. Only in the case of the selective communications designation (SL), the UID of the Tag that is being written to is added to the data.
Read area start address	Specifies the start address of the area in the Tag from which data is to be read from in 4-digit hexadecimal. Setting range: 0000H to FFFFH
No. of bytes to copy	Specifies the number of bytes of data to copy in 4-digit hexadecimal. Setting range: 0001H to 0800H
Destination start address	Specifies the start address of the area in the Tag to which data is to be written in 4-digit hexadecimal. Setting range: 0000H to FFFFH



The communications designation for the Antenna that reads data is always single trigger (ST). The communications designation specified in the command is used for the Antenna that writes data.

**CHECK!** For a communications designation that specifies repeating, data writing will be repeated for other Tags after data is written to the first Tag.

#### Response

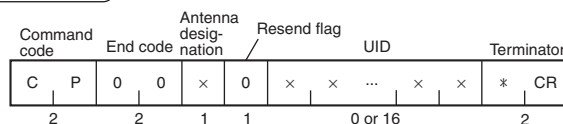



**Note:** When using the multi-access trigger communications designation (MT), the ID controller returns an end code of 03 after communicating with all Tags.

UID	A unique identifier used to identify Tags. In the case of multi-access communications designations (MT/MR), the UID of the Tag that is being written to is added to the data.
-----	--

1:N Protocol

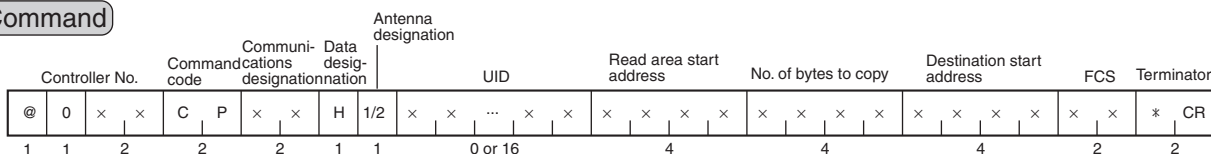
Command



Communications designa- tion	Specifies the method of communications with the Tag. Refer to Communications Designation Function for details on the communications designation.  p. 103
Data designation	Always "H".
Antenna designation	Specifies the Antenna with which to communicate. "1": Reads from Antenna 1 and writes to Antenna 2. "2": Reads from Antenna 2 and writes to Antenna 1.
UID	A unique identifier used to identify Tags. Only in the case of the selective communications designation (SL), the UID of the Tag that is being written to is added to the data.
Read area start address	Specifies the start address of the area in the Tag from which data is to be read from in 4-digit hexadecimal. Setting range: 0000H to FFFFH
No. of bytes to copy	Specifies the number of bytes of data to copy in 4-digit hexadecimal. Setting range: 0001H to 0800H
Destination start address	Specifies the start address of the area in the Tag to which data is to be written in 4-digit hexadecimal. Setting range: 0000H to FFFFH



The communications designation for the Antenna that reads data is always single trigger (ST). The communications designation specified in the command is used for the Antenna that writes data.

**CHECK!** For a communications designation that specifies repeating, data writing will be repeated for other Tags after data is written to the first Tag.

Response

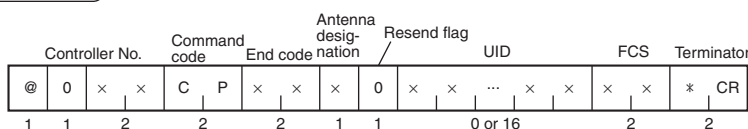

**Note:** When using the multi-access trigger communications designation (MT), the ID controller returns an end code of 03 after communicating with all Tags.

UID	A unique identifier used to identify Tags. In the case of multi-access communications designations (MT/MR), the UID of the Tag that is being written to is added to the data.
-----	--

## ■ AUTO COPY (AP)

When the ID Controller receives an AUTO COPY command, it waits for Tags to approach and then reads data from the memory of a Tag using one Antenna and writes it to the memory of the Tag in the other Antenna's communications area. This command cannot be used with the V680-CA5D01-V2.

### ■ 1:1 Protocol

#### Command

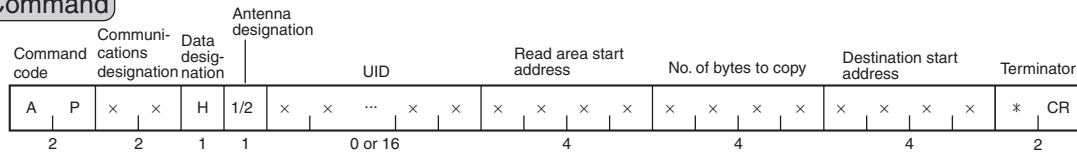

Communications designation	Specifies the method of communications with the Tag. Refer to Communications Designation Function for details on the communications designation.  p. 103
Data designation	Always "H".
Antenna designation	Specifies the Antenna with which to communicate. "1": Reads from Antenna 1 and writes to Antenna 2. "2": Reads from Antenna 2 and writes to Antenna 1.
UID	A unique identifier used to identify Tags. Only in the case of the selective communications designation (SL), the UID of the Tag that is being written to is added to the data.
Read area start address	Specifies the start address of the area in the Tag from which data is to be read from in 4-digit hexadecimal. Setting range: 0000H to FFFFH
No. of bytes to copy	Specifies the number of bytes of data to copy in 4-digit hexadecimal. Setting range: 0001H to 0800H
Destination start address	Specifies the start address of the area in the Tag to which data is to be written in 4-digit hexadecimal. Setting range: 0000H to FFFFH



The communications designation for the Antenna that reads data is always "single auto" (SA). The communications designation specified in the command is used for the Antenna that writes data.

**CHECK!** For a communications designation that specifies repeating, data writing will be repeated for other Tags after data is written to the first Tag.

#### Response

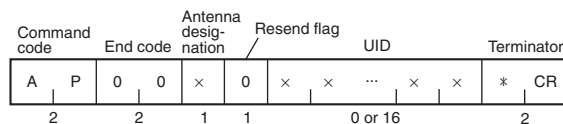



**Note:** When using the multi-access trigger communications designation (MT), the ID controller returns an end code of 03 after communicating with all Tags.

UID	A unique identifier used to identify Tags. In the case of multi-access communications designations (MT/MR), the UID of the Tag that is being written to is added to the data.
-----	--

1:N Protocol

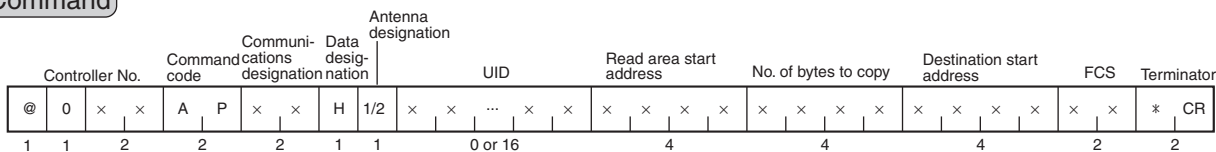
Command



Communications designation	Specifies the method of communications with the Tag. Refer to Communications Designation Function for details on the communications designation.  p. 103
Data designation	Always "H".
Antenna designation	Specifies the Antenna with which to communicate. "1": Reads from Antenna 1 and writes to Antenna 2. "2": Reads from Antenna 2 and writes to Antenna 1.
UID	A unique identifier used to identify Tags. Only in the case of the selective communications designation (SL), the UID of the Tag that is being written to is added to the data.
Read area start address	Specifies the start address of the area in the Tag from which data is to be read from in 4-digit hexadecimal. Setting range: 0000H to FFFFH
No. of bytes to copy	Specifies the number of bytes of data to copy in 4-digit hexadecimal. Setting range: 0001H to 0800H
Destination start address	Specifies the start address of the area in the Tag to which data is to be written in 4-digit hexadecimal. Setting range: 0000H to FFFFH



The communications designation for the Antenna that reads data is always "single auto" (SA). The communications designation specified in the command is used for the Antenna that writes data.

**CHECK!** For a communications designation that specifies repeating, data writing will be repeated for other Tags after data is written to the first Tag.

Response

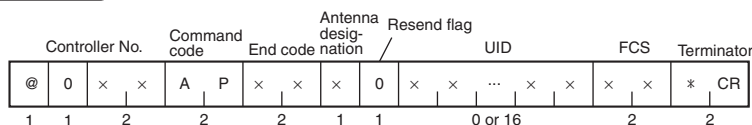

**Note:** When using the multi-access trigger communications designation (MT), the ID controller returns an end code of 03 after communicating with all Tags.

UID	A unique identifier used to identify Tags. In the case of multi-access communications designations (MT/MR), the UID of the Tag that is being written to is added to the data.
-----	--

## ■ LARGE READ (ER)

The LARGE READ command reads up to 8 KB of data from a Tag. If there is no Tag, the ID Controller returns an error response with an error code of 72 (Tag missing error).

### ■ 1:1 Protocol

#### Command

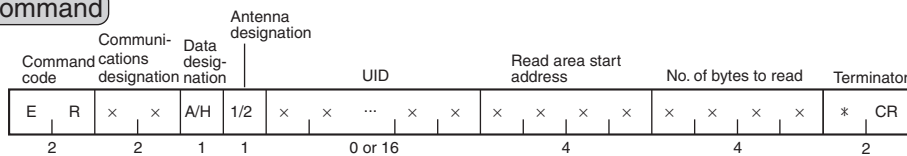

Communications designation	Specifies the method of communications with the Tag. Communications designations other than single trigger (ST), single auto (SA), single input trigger (SI), and selective (SL) cannot be used. Refer to Communications Designation Function for details on the communications designation.  p. 103
Data designation	Specifies the code format when sending the read data response. "A": ASCII "H": Hexadecimal
Antenna designation	Specifies the Antenna with which to communicate. "1": Antenna 1 "2": Antenna 2
UID	A unique identifier used to identify Tags. Added only for the selective communications designation (SL).
Read area start address	Specifies the start address of the area in the Tag from which data is to be read from in 4-digit hexadecimal. Setting range: 0000H to FFFFH
No. of bytes to read	Specifies the number of bytes to read from the Tag in 4-digit hexadecimal. Up to 8,192 bytes can be read with one command. Setting range: 0001H to 2000H <ul style="list-style-type: none"> <li>1000 Byte Tags (V680-D1KP□□) <ul style="list-style-type: none"> <li>ASCII: 1000 bytes (1000 characters)</li> <li>Hexadecimal: 1000 bytes (2000 characters)</li> </ul> </li> <li>8-/32-KB Tags (V680-D8KF68/-D32KF68) <ul style="list-style-type: none"> <li>ASCII: 8192 bytes (8192 characters)</li> <li>Hexadecimal: 8192 bytes (16384 characters)</li> </ul> </li> <li>2000 Byte Tags (V680-D2KF□□) <ul style="list-style-type: none"> <li>ASCII: 2000 bytes (2000 characters)</li> <li>Hexadecimal: 2000 bytes (4000 characters)</li> </ul> </li> </ul>

#### Response

#### Response When the Read Data Consists of 2,048 or Fewer Characters

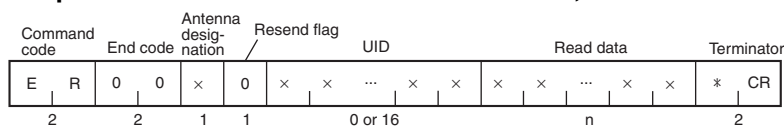

**Response When the Read Data Consists of More Than 2,048 Characters**

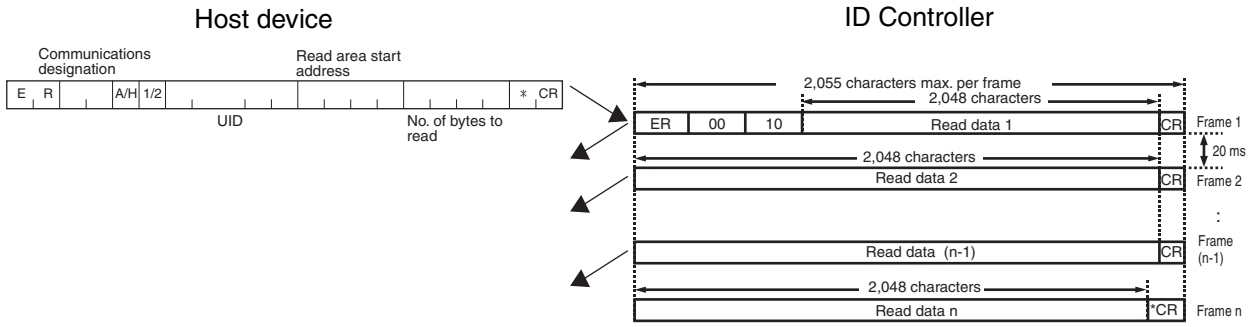

UID	A unique identifier used to identify Tags. In the case of multi-access communications designations (MT/MR), the UID of the Tag that is being written to is added to the data.
Read data	The data read from the Tag. The number of characters will be the same as the specified number of bytes to read for ASCII data and twice that number for hexadecimal data.



1:N Protocol

Command

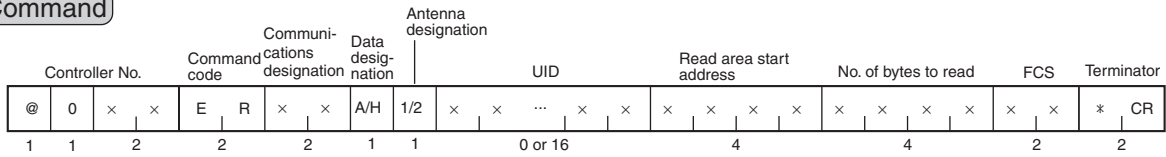

Communications designation	Specifies the method of communications with the Tag. Refer to Communications Designation Function for details on the communications designation. p. 103
Data designation	Specifies the code format when sending the read data response. "A": ASCII "H": Hexadecimal
Antenna designation	Specifies the Antenna with which to communicate. "1": Antenna 1 "2": Antenna 2
UID	A unique identifier used to identify Tags. In the case of multi-access communications designations (MT/MR), the UID of the Tag that is being written to is added to the data.
Read area start address	Specifies the start address of the area in the Tag from which data is to be read from in 4-digit hexadecimal. Setting range: 0000H to FFFFH
No. of bytes to read	Specifies the number of bytes to read from the Tag in 4-digit hexadecimal. Up to 8,192 bytes can be read with one command. Setting range: 0001H to 2000H <ul style="list-style-type: none"> <li>1000 Byte Tags (V680-D1KP□□)                         <ul style="list-style-type: none"> <li>ASCII: 1000 bytes (1000 characters)</li> <li>Hexadecimal: 1000 bytes (2000 characters)</li> </ul> </li> <li>8-/32-KB Tags (V680-D8KF68/-D32KF68)                         <ul style="list-style-type: none"> <li>ASCII: 8192 bytes (8192 characters)</li> <li>Hexadecimal: 8192 bytes (16384 characters)</li> </ul> </li> <li>2000 Byte Tags (V680-D2KF□□)                         <ul style="list-style-type: none"> <li>ASCII: 2000 bytes (2000 characters)</li> <li>Hexadecimal: 2000 bytes (4000 characters)</li> </ul> </li> </ul>

Response

Response When the Read Data Consists of 2,048 or Fewer Characters

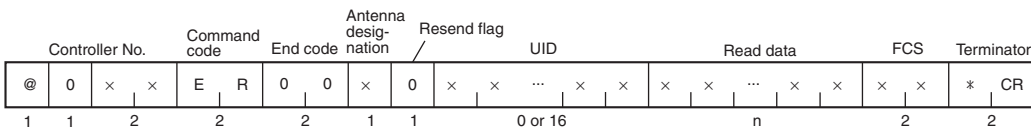

Response When the Read Data Consists of More Than 2,048 Characters

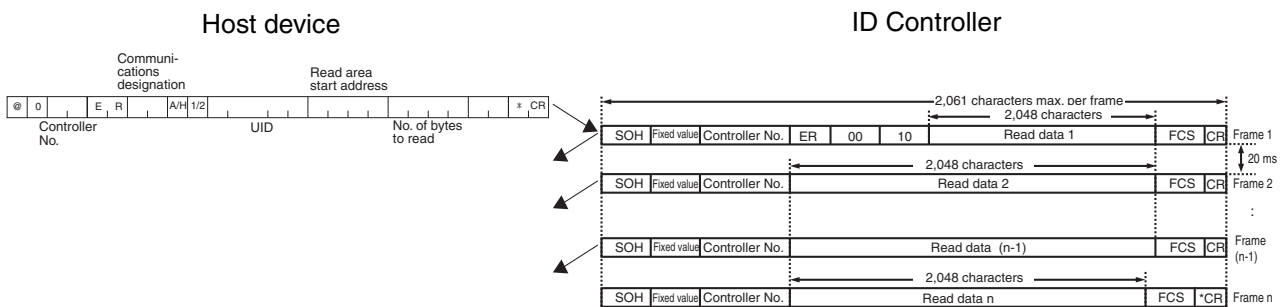

UID	Added when the ADD UID (US) command is set to add a UID, or when a multi-access communications designation (MT/MR) is specified.
Read data	The data read from the Tag. The number of characters will be the same as the specified number of bytes to read for ASCII data and twice that number for hexadecimal data.

### ■ READ TAG MEMORY ERROR CORRECTION (QR)

Reads Tag data from the area written by the WRITE TAG MEMORY ERROR CORRECTION (QW) command, and performs 1-bit error correction. Be sure to read the same area that was written by the QW command.

#### ■ 1:1 Protocol

##### Command

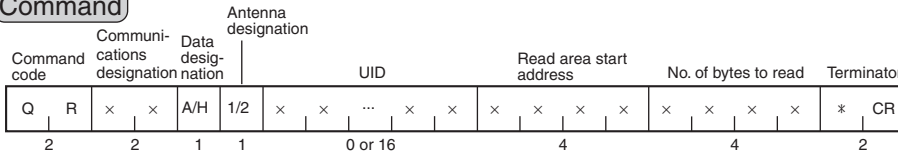

Communications designation	Specifies the method of communications with the Tag. Refer to Communications Designation Function for details on the communications designation.  p. 103
Data designation	Specifies the code format when sending the read data response. "A": ASCII "H": Hexadecimal
Antenna designation	Specifies the Antenna with which to communicate. "1": Antenna 1 "2": Antenna 2
UID	A unique identifier used to identify Tags. Added only for the selective communications designation (SL).
Read area start address	Specifies the start address of the area in the Tag from which data is to be read from in 4-digit hexadecimal. Setting range: 0000H to FFFAH
No. of bytes to read	Specifies the number of bytes to read from the Tag in 4-digit hexadecimal. Up to 510 bytes can be read with one command. Setting range: 0001H to 01FEH • ASCII: 510 bytes (510 characters) • Hexadecimal: 510 bytes (1,020 characters)

##### Response

#### Communications Designation Other Than PA or PI

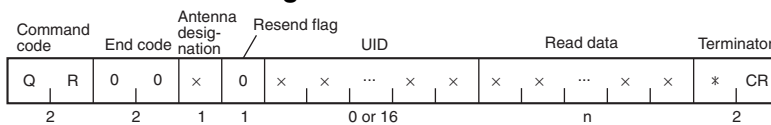

**Note:** When using the multi-access trigger communications designation (MT), the ID controller returns an end code of 03 after communicating with all Tags.

#### Communications Designation of PA or PI

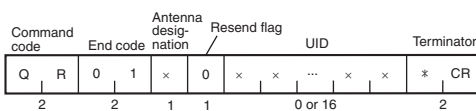

Antenna designation	Specifies the Antenna with which to communicate. "1": Antenna 1 "2": Antenna 2 <b>Note:</b> If a host communications error (other than error code 15) is generated, a "0" will be added.
UID	Added when the ADD UID (US) command is set to add a UID, or when a multi-access communications designation (MT/MR) is specified.
Read data	The data read from the Tag. The number of characters will be the same as the specified number of bytes to read for ASCII data and twice that number for hexadecimal data.

1:N Protocol

Command

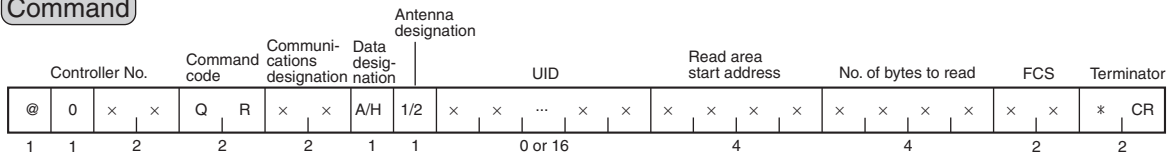

Communications designation	Specifies the method of communications with the Tag. Refer to Communications Designation Function for details on the communications designation.  p. 103
Data designation	Specifies the code format when sending the read data response. "A": ASCII "H": Hexadecimal
Antenna designation	Specifies the Antenna with which to communicate. "1": Antenna 1 "2": Antenna 2
UID	A unique identifier used to identify Tags. Added only for the selective communications designation (SL).
Read area start address	Specifies the start address of the area in the Tag from which data is to be read from in 4-digit hexadecimal. Setting range: 0000H to FFFFH
No. of bytes to read	Specifies the number of bytes to read from the Tag in 4-digit hexadecimal. Up to 510 bytes can be read with one command. Setting range: 0001H to 01FEH • ASCII: 510 bytes (510 characters) • Hexadecimal: 510 bytes (1,020 characters)

Response

Communications Designation Other Than PA or PI



**Note:** When using the multi-access trigger communications designation (MT), the ID controller returns an end code of 03 after communicating with all Tags.

Communications Designation of PA or PI

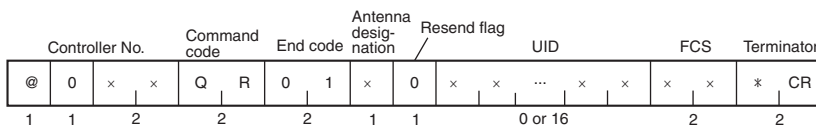

Antenna designation	Specifies the Antenna with which to communicate. "1": Antenna 1 "2": Antenna 2 <b>Note:</b> If a host communications error (other than error code 15) is generated, a "0" will be added.
UID	Added when the ADD UID (US) command is set to add a UID, or when a multi-access communications designation (MT/MR) is specified.
Read data	The data read from the Tag. The number of characters will be the same as the specified number of bytes to read for ASCII data and twice that number for hexadecimal data.

■ WRITE TAG MEMORY ERROR CORRECTION (QW)

Writes data to a Tag. A tag memory check and 5-byte error correct code are written consecutively after the written data. Do not change this code, as it is required by the READ TAG MEMORY ERROR CORRECTION (QR) command.

■ 1:1 Protocol

Command

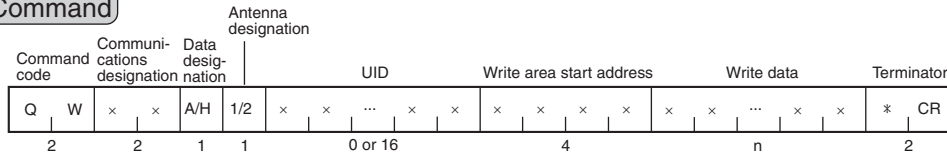

Communications designation	Specifies the method of communications with the Tag. Refer to Communications Designation Function for details on the communications designation. p. 103
Data designation	Specifies the code format when sending the read data response. “A”: ASCII “H”: Hexadecimal
Antenna designation	Specifies the Antenna with which to communicate. “1”: Antenna 1 “2”: Antenna 2
UID	A unique identifier used to identify Tags. Added only for the selective communications designation (SL).
Read area start address	Specifies the start address of the area in the Tag from which data is to be read from in 4-digit hexadecimal. Setting range: 0000H to FFFAH
No. of bytes to read	Specifies the number of bytes to read from the Tag in 4-digit hexadecimal. Up to 510 bytes can be read with one command. Setting range: 0001H to FFFAH • ASCII: 510 bytes (510 characters) • Hexadecimal: 510 bytes (1020 characters)

Response

Communications Designation Other Than PA or PI

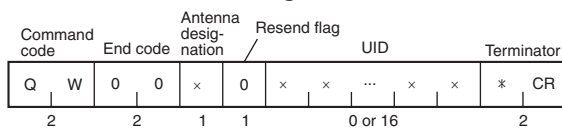

**Note:** When using the multi-access trigger communications designation (MT), the ID controller returns an end code of 03 after communicating with all Tags.

Communications Designation of PA or PI

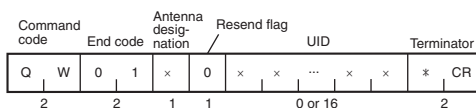

UID	A unique identifier used to identify Tags. In the case of multi-access communications designations (MT/MR), the UID of the Tag that is being written to is added to the data.
-----	--

▪ 1:N Protocol

Command

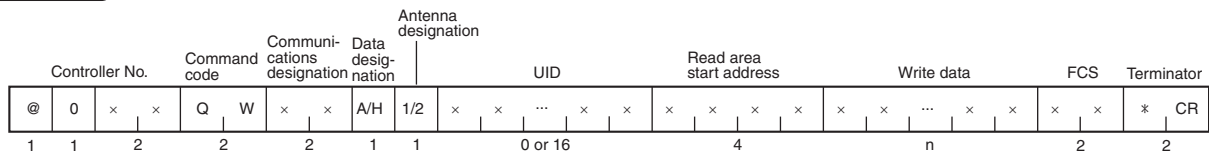

Communications designation	Specifies the method of communications with the Tag. Refer to Communications Designation Function for details on the communications designation.  p. 103
Data designation	Specifies the code format when sending the read data response. "A": ASCII "H": Hexadecimal
Antenna designation	Specifies the Antenna with which to communicate. "1": Antenna 1 "2": Antenna 2
UID	A unique identifier used to identify Tags. Added only for the selective communications designation (SL).
Read area start address	Specifies the start address of the area in the Tag from which data is to be read from in 4-digit hexadecimal. Setting range: 0000H to FFFAH
No. of bytes to read	Specifies the number of bytes to read from the Tag in 4-digit hexadecimal. Up to 510 bytes can be read with one command. Setting range: 0001H to FFFAH • ASCII: 510 bytes (510 characters) • Hexadecimal: 510 bytes (1,020 characters)

Response

Communications Designation Other Than PA or PI

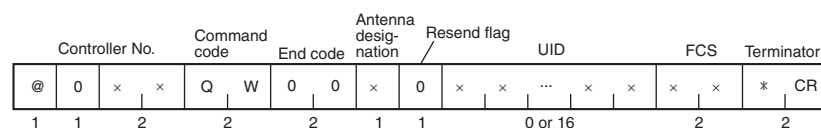

**Note:** When using the multi-access trigger communications designation (MT), the ID controller returns an end code of 03 after communicating with all Tags.

Communications Designation of PA or PI

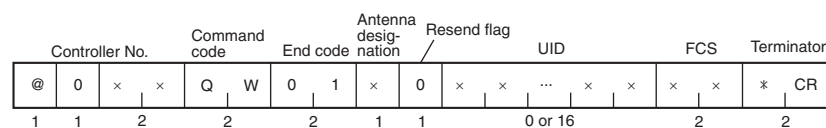

UID	A unique identifier used to identify Tags. In the case of multi-access communications designations (MT/MR), the UID of the Tag that is being written to is added to the data.
-----	--

## Communications Subcommands

Communications subcommands are used in combination with commands for Tag communications. They cannot be used by themselves to communicate with a Tag.

### ■ POLLING QUERY (PC)

#### ■ 1:1 Protocol

##### Command

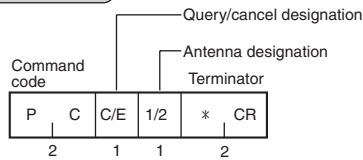

Query/cancel designation	Specifies querying or canceling polling auto processing. “C”: Processing results query “E”: Processing cancelled.
Antenna designation	Specifies the Antenna with which to communicate. “1”: Antenna 1 “2”: Antenna 2

#### Response When a Processing Results Query Is Executed after Tag Communications

The ID Controller returns a response according to the specifications of the polling command that was executed.

#### Response When a Processing Results Query Is Executed before Tag Communications

##### Response

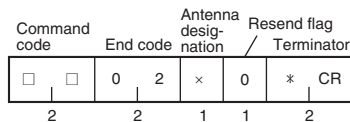

Command code	The command code is the same as the only specified when polling processing was executed.
--------------	--

#### Response When Cancelling Processing Results

##### Response

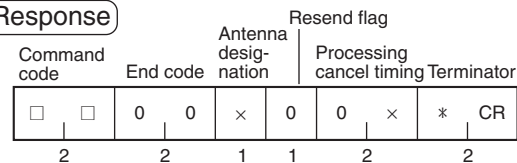

Command code	The command code is the same as the only specified when polling processing was executed.
Processing cancel timing	Indicates the timing when polling processing was cancelled. “00”: There was no Tag in the communications area when polling processing was cancelled. “01”: Communications were in progress with the Tag or processing had been completed when polling processing was cancelled.

#### Response for a Processing Results Query for an Antenna That Is Not Executing Polling Processing

##### Response

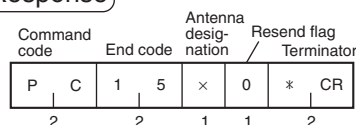

1:N Protocol

Command

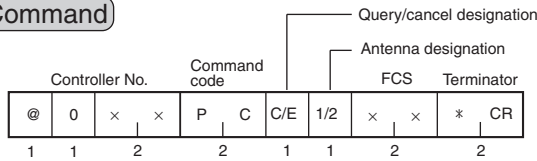

Query/cancel designation	Specifies querying or canceling polling auto processing. “C”: Processing results query “E”: Processing results cancel
Antenna designation	Specifies the Antenna with which to communicate. “1”: Antenna 1 “2”: Antenna 2

Response When a Processing Results Query Is Executed after Tag Communications

The ID Controller returns a response according to the specifications of the polling command that was executed.

Response When a Processing Results Query Is Executed before Tag Communications

Response

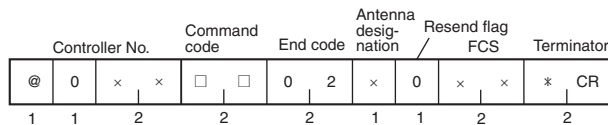

Command code	The command code is the same as the only specified when polling processing was executed.
--------------	--

Response When Cancelling Processing Results

Response

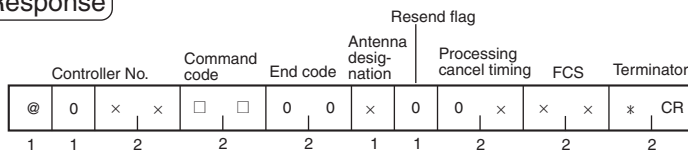

Command code	The command code is the same as the only specified when polling processing was executed.
Processing cancel timing	Indicates the timing when polling processing was cancelled. “00”: There was no Tag in the communications area when polling processing was cancelled. “01”: Communications were in progress with the Tag or processing had been completed when polling processing was cancelled.

Response for a Processing Results Query for an Antenna That Is Not Executing Polling Processing

Response

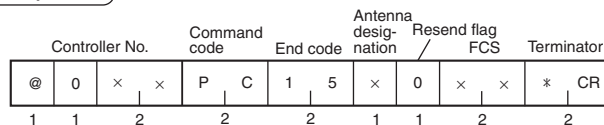

■ **COMMAND PROCESSING TERMINATE (AA)**

The COMMAND PROCESSING TERMINATE command cancels any command except for polling commands and returns the ID Control to command standby status.

■ **1:1 Protocol**

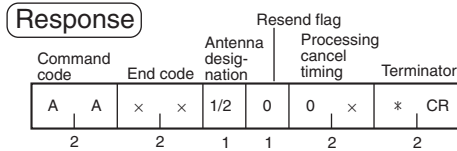
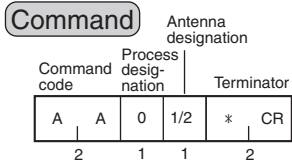

Processing cancel timing	Indicates the timing when polling processing was cancelled. “00”: Command was cancelled before a Tag was detected. “01”: Command was cancelled after a Tag was detected.
--------------------------	--

■ **1:N Protocol**

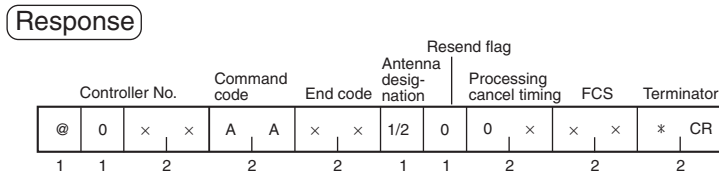
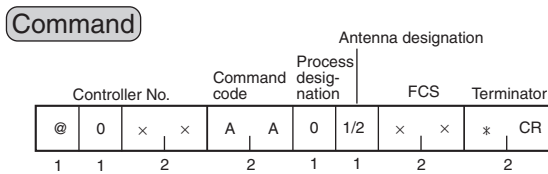

Processing cancel timing	Indicates the timing when polling processing was cancelled. “00”: Command was cancelled before a Tag was detected. “01”: Command was cancelled after a Tag was detected.
--------------------------	--



## ■ ABORT (XZ)

The ABORT command can be used to reset the ID Controller to command standby status during communications with the host device or a Tag if any sort of trouble occurs, e.g., if the ID Controller does not return a response. The ID Controller will return to command standby status after it is reset. The ID Controller does not return a response to the ABORT command.

### ■ 1:1 Protocol

#### Command

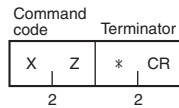

CHECK!

About 100 ms is required after the ID Controller receives the ABORT command before it can receive the next command.

### ■ 1:N Protocol

#### Command

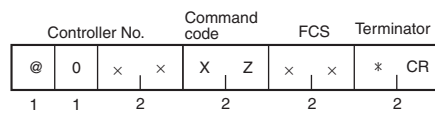

CHECK!

About 100 ms is required after the ID Controller receives the ABORT command before it can receive the next command.

## CONTROLLER CONTROL Commands

### ■ UID ADDITION SET (US)

Sets whether or not UID should be added to the read command (RD) response or read tag memory error correction (QR) response.

#### ■ 1:1 Protocol

##### Command

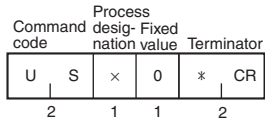

Process designation	Specify whether or not to add a UID. "0": Do not add a UID "1" Add a UID
---------------------	--

##### Response

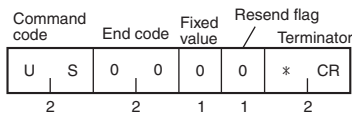

#### ■ 1:N Protocol

##### Command

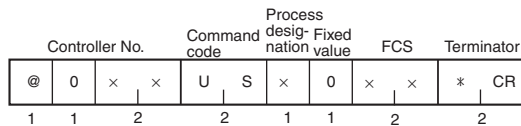

Process designation	Specify whether or not to add a UID. "0": Do not add a UID "1" Add a UID
---------------------	--

##### Response

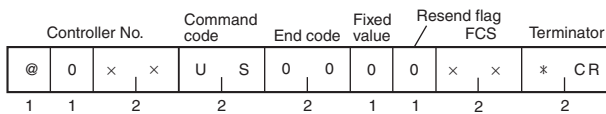

## ■ COMMUNICATIONS SET (TR)

The COMMUNICATIONS SET command is used to set serial communications parameters. To use the ID Controller with the new parameters, either restart the ID Controller or execute the ABORT command (XZ).



This command is valid only when internal settings are enabled (i.e., when pin 1 on SW3 is ON).

### ■ 1:1 Protocol

#### Command

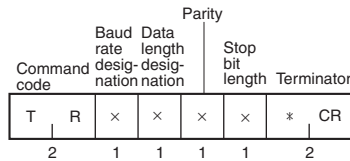

Baud rate designation	Specify the baud rate. "3": 9,600 bps "4": 19,200 bps "5": 38,400 bps "6": 115,200 bps Default setting: 9,600 bps
Data length designation	Specify the data length. "7": 7 bits "8": 8 bits Default setting: 7 bits
Parity	Specify the type of parity. "0": None "1": Odd parity "2": Even parity Default setting: Even parity
Stop bit length	Specify the number of stop bits. "1": 1 bit "2": 2 bits Default setting: 2 bits

#### Response

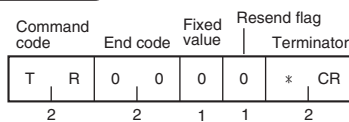

▪ 1:N Protocol

Command

Controller No.		Command code		Baud rate designation	Data length designation	Parity	Stop bit length	FCS	Terminator
@	0	x	x	T	R	x	x	x	x
1	1	2	2	1	1	1	1	2	2

Baud rate designation	Specify the baud rate. "3": 9,600 bps "4": 19,200 bps "5": 38,400 bps "6": 115,200 bps Default setting: 9,600 bps
Data length designation	Specify the data length. "7": 7 bits "8": 8 bits Default setting: 7 bits
Parity	Specify the type of parity. "0": None "1": Odd parity "2": Even parity Default setting: Even parity
Stop bit length	Specify the number of stop bits. "1": 1 bit "2": 2 bits Default setting: 2 bits

Response

Controller No.		Command code		End code	Fixed value	Resend flag	FCS	Terminator
@	0	x	x	T	R	0	0	0
1	1	2	2	2	1	1	2	2

## ■ PARAMETER SET (SP)

The PARAMETER SET command is used to set conditions for communicating with Tags. The various parameters are set in the ID Controller.



The ID Controller does not need to be reset when internal settings are changed. The new settings are effective immediately.

CHECK!



A memory error will occur if the power supply is interrupted while parameters are being changed.

CHECK!

### ■ 1:1 Protocol

#### Command

Command code	Process code	Parameter data (when there are changes)	Terminator
S	P	x (Upper digit) x (Lower digit)	x x x x * CR
2	2	0 to 4	2

Process code (Upper digit)	Specifies the process to perform for the parameter. “0”: Change internal setting. “1”: Read internal setting. “9”: Return initial setting to default value.	
Process code (Lower digit)	Specifies the parameter. “1”: Controller No. (See note 1.) “2”: Write verification enable (See note 1.) “3”: Reception sensitivity “9”: Tag communications procedure (See note 1.) “C”: Error output time “D”: Number of test bytes setting “E”: Tag history noise detection enable (Noise monitor function setting) “F”: Output contact mode setting “G”: Noise detection count setting “H”: Write protection setting (See note 1.)	
Parameter data (when there are changes)	Data No. (See note 2.)	Settable values
	“1”	Specify 2 decimal digits. “00” to “31” (unit number) Default value: “00”
	“2”	“0”: Without verification “1”: With verification (default value)
	“3”	“0”: Weak “1”: Standard (default value)
	“9”	“00”: 1:1 protocol (default value) “01”: 1:N protocol

Parameter data (when there are changes)	Data No. (See note 2.)	Settable values
	"C"	Specify 4 decimal digits. "0000" to "9999" (ms) "0000": Infinite, Default value: "0500" (ms)
	"D"	Specify 4 hexadecimal digits. "0001" to "0800" (bytes) Default value: "0001" (bytes)
	"E"	"00": No noise detection for communications history (default value) Noise monitor function disabled. "01": Noise detection for communications history Noise monitor function enabled.
	"F"	"00": Two Output Mode BUSY, ERROR, OUT1, and OUT2 (default value) "01": Four Output Mode OUT1, OUT2, OUT3, and OUT4
	"G"	Specify 4 decimal digits. "0001" to "0100" (times) Default value: "0010" (times)
	"H"	"00": Write protection OFF "01": Write protection ON (default value)

**Note 1:** Parameters 1, 2, 9, and H are valid only when internal settings are enabled (i.e., when pin 1 on SW3 is ON).

**Note 2:** The data number of the parameter data is the number specified for the lower digit of the process code.

The settable values for the data number are the same as for the parameter specified by the lower digit of the process code.

**Response**

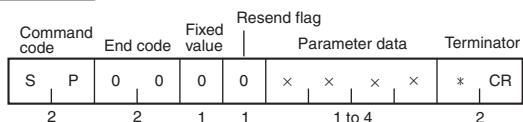

Parameter data	Attached only when parameter data is being obtained.
----------------	--

1:N Protocol

Command

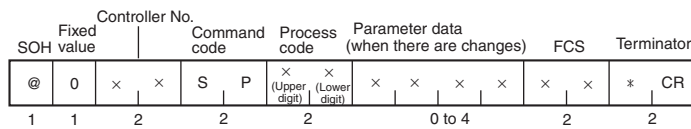

Process code (Upper digit)	Specifies the process to perform for the parameter. “0”: Change internal setting. “1”: Read internal setting. “9”: Return initial setting to default value.	
Process code (Lower digit)	Specifies the parameter. “1”: Controller No. (See note 1.) “2”: Write verification enable (See note 1.) “3”: Reception sensitivity “9”: Tag communications procedure (See note 1.) “C”: Error output time “D”: Number of test bytes setting “E”: Tag history noise detection enable (Noise monitor function setting) “F”: Output contact mode setting “G”: Noise detection count setting “H”: Write protection setting (See note 1.)	
Parameter data (when there are changes)	Data No. (See note 2.)	Settable values
	“1”	Specify 2 decimal digits. “00” to “31” (unit number) Default value: “00”
	“2”	“0”: Without verification “1” With verification (default value)
	“3”	“0”: Weak “1”: Standard
	“9”	“00”: 1:1 protocol (default value) “01”: 1:N protocol
	“C”	Specify 4 decimal digits. “0000” to “9999” (ms) “0000”: Infinite, Default value: “0500” (ms)
	“D”	Specify 4 hexadecimal digits. “0001” to “0800” (bytes) Default value: “0001” (bytes)
	“E”	“00”: No noise detection for communications history (default value) Noise monitor function disabled. “01”: Noise detection for communications history Noise monitor function enabled.
	“F”	“00”: Two Output Mode BUSY, ERROR, OUT1, and OUT2 (default value) “01”: Four Output Mode OUT1, OUT2, OUT3, and OUT4
	“G”	Specify 4 decimal digits. “0001” to “0100” (times) Default value: “0010” (times)
“H”	“00”: Write protection OFF “01”: Write protection ON (default value)	

**Note 1:** Parameters 1, 2, 9, and H are valid only when internal settings are enabled (i.e., when pin 1 on SW3 is ON).

**Note 2:** The data number of the parameter data is the number specified for the lower digit of the process code.  
The settable values for the data number are the same as for the parameter specified by the lower digit of the process code.

**Response**

Controller No.		Command code		End code		Fixed value	Resend flag	Parameter data				FCS		Terminator			
@	0	x	x	S	P	0	0	0	0	x	x	x	x	x	x	*	CR
1	1	2		2		1	1	1 to 4				2		2			

Parameter data	Attached only when parameter data is being obtained.
----------------	--



## ■ OPERATION MODE CHANGE (MO)

The OPERATION MODE CHANGE command is used to change the mode of the ID Controller.

### ■ 1:1 Protocol

#### Command

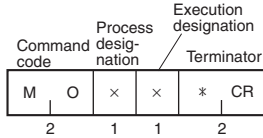

Process designation	Specifies the operation mode of the ID Controller. S: Self Execution Mode C: Command Execution Mode P: Host Communications Monitor Mode
Execution designation	Always "0".



CHECK!

Before changing the operation mode to Self Execution Mode, use the OPERATION CONDITION SET command to set the operation conditions. If the OPERATION MODE CHANGE command is executed with the process designation set to "S" when the operation conditions have not been set, an execution status error (end code 15) will occur.



p. 153



CHECK!

If the OPERATION MODE CHANGE command is executed in Host Communications Monitor Mode with the process designation set to "S," an execution status error (end code 15) will occur. To change from Host Communications Monitor Mode to Self Execution Mode, first change to Command Execution Mode.

#### Response

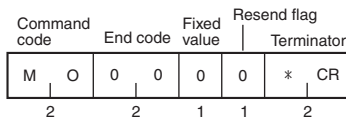

### ■ 1:N Protocol

#### Command

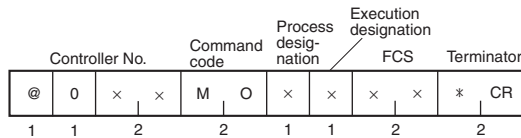

Process designation	Specifies the operation mode of the ID Controller. S: Self Execution Mode C: Command Execution Mode P: Host Communications Monitor Mode
Execution designation	Always "0".



CHECK!

Before changing the operation mode to Self Execution Mode, use the OPERATION CONDITION SET command to set the operation conditions. If the OPERATION MODE CHANGE command is executed with the process designation set to "S" when the operation conditions have not been set, an execution status error (end code 15) will occur.



p. 153



CHECK!

If the OPERATION MODE CHANGE command is executed in Host Communications Monitor Mode with the process designation set to "S," an execution status error (end code 15) will occur. To change from Host Communications Monitor Mode to Self Execution Mode, first change to Command Execution Mode.

Response

Controller No.		Command code		End code		Fixed value	Resend flag	FCS		Terminator	
@	0	x	x	M	0	0	0	x	x	*	CR
1	1	2	2	2	2	1	1	2	2	2	2

## ■ OPERATION CONDITION SET (SE)

The OPERATION CONDITION SET command is used to set operation conditions for the Self Execution Mode. Always set the operation conditions in the following order from 1 to 5.

### 1. Clear the Operation Conditions

#### Command

Command code	Process code	Terminator
S   E	2   0	*   CR
2	2	2

Process code	Always "20".
--------------	--------------

#### Response

Command code	End code	Fixed value	Resend flag	Terminator
S   E	x   x	0	0	*   CR
2	2	1	1	2

### 2. Set the Execution Command

#### Command

Command code	Process code	Operation condition parameter	Execution Command	Terminator
S   E	0   0	x   x	x   x   ...   x   x	*   CR
2	2	2	n	2

Process code	Always "00".
Operation condition parameter	<p>"C1": Sets an execution command for channel 1.                      "C2": Sets an execution command for channel 2.</p> <p><b>Note:</b> "C2" will result in an error (15) if specified for a One-channel Controller (V680-CA5D01-V2). Also, if execution commands are not set for both channels 1 and 2 for a Two-channel Controller (V680-CA5D02-V2), the output conditions cannot be set.</p>
Execution command string	<p>Specifies the command to be executed, with the following restrictions.</p> <ol style="list-style-type: none"> <li>1. Only Tag communications commands can be set: RD, WT, DF, or MD.</li> <li>2. The communications designation must be RA or RI.</li> <li>3. A maximum of 256 bytes can be written (for either ASCII or hexadecimal data)</li> </ol> <p>The execution command will be set to "XX" if the execution command string is omitted.</p>

#### Response

Command code	End code	Fixed value	Resend flag	Terminator
S   E	x   x	0	0	*   CR
2	2	1	1	2

### 3. Set the Output Conditions

#### Command

Command code	Process code	Operation condition parameter	Comparison antenna	Condition A	Comparison parameter A	Operator	Condition B	Comparison parameter B	Output parameter	Terminator
S	E	0	0	x	x	x	x	x	x	x
2	2	2	2	2	n	2	2	n	4	2

**Note:** There are the following three patterns for comparison conditions A and B depending on the conditions.

- When Data Criteria Are Used for Conditions A and B

Comparison parameters A and B	Number of data bytes A and B	Comparison parameters A and B
x	x	x
x	x	x
x	x	x
x	x	x
4	2	n

- When "ER" Is Specified as the Communications Criteria for Conditions A and B

Comparison parameters A and B
x
x
x
x
x
x
x
x
x
8

- When "OK" or "AL" Is Specified as the Communications Judgements Conditions A and B

There are no parameters in this case.

Process code		Always "00".
Operation condition parameter		"S1": OUT1 output condition setting "S2": OUT2 output condition setting "S3": OUT3 output condition setting "S4": OUT4 output condition setting <b>Note:</b> "S3" or "S4" will result in an error (15) in Two Output Mode. Also, if output conditions are not set for OUT1 through OUT3, the execution command output destination cannot be set.
Comparison antenna		"01": Compare to channel 1 "02": Compare to channel 2 "XX": No output
Conditions A and B	Data criteria	"==" : Criteria data match, "!=" : Criteria data does not match, ">=" : Equal to or higher than criteria, "<=" : Equal to or less than criteria, Data criteria can be used only for READ commands.
	Communications criteria	"OK": Communication OK, "ER": Communications error, "AL": Always
Data offsets A and B		Specifies the offset to the portion of the read data to use as the criteria. Setting range: 0000H to FFFFH
Number of data bytes A and B		Specifies the number of bytes to use as the criteria. Setting range: 01H to 10H
Comparison parameters A and B	When conditions A and B are data criteria	Specifies the comparison data to use as the data criteria. (The same length as the designated number of data bytes for either ASCII and hexadecimal data.)
	When conditions A and B are "ER" communications criteria	Specifies the error code. "00000000" specifies all error codes. Example: "707A0000" specifies a Tag communications error and address error.
Operator		Operator between condition A and condition B "&&": AND, "++": OR
Output parameter		Specifies the output ON time in milliseconds. Setting range: "0001" to "9999" (ms), ("0000": Hold until next judgment)

#### Response

Command code	End code	Fixed value	Resend flag	Terminator
S	E	x	x	0
2	2	1	1	2
				* CR

#### 4. Set the Output Destination for the Execution Command

##### Command

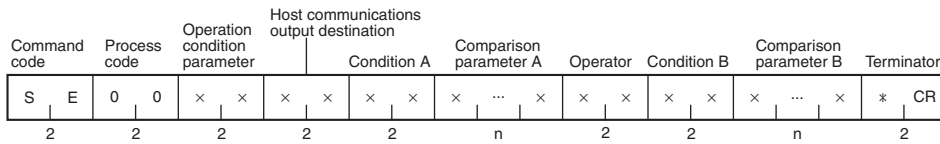

**Note:** There are the following three patterns for comparison conditions A and B depending on the conditions.

- When Data Criteria Are Used for Conditions A and B

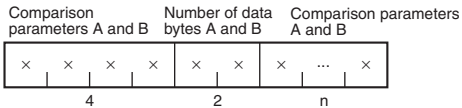

- When "ER" Is Specified as the Communications Criteria for Conditions A and B

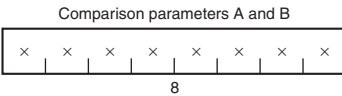

- When "OK" or "AL" Is Specified as the Communications Judgements Conditions A and B

There are no parameters in this case.

Process code		Always "00".
Operation condition parameter		"U1": Sets the output destination for the execution command for channel 1. "U2": Sets the output destination for the execution command for channel 2. <b>Note:</b> "U2" will result in an error (15) if specified for a One-channel Controller (V680-CA5D01-V2). For a Two-channel Controller (V680-CA5D02-V2), set the execution command output destination for both channels 1 and 2.
Host communications output destination		"01": Output from RS-232C. "02": Output from RS-485. "03": Output from USB. "XX": Do not output.
Conditions A and B	Data criteria	"==" : Criteria data match, "!=" : Criteria data does not match, ">=" : Equal to or higher than criteria, "<=" : Equal to or less than criteria, Data criteria can be used only for READ commands.
	Communications criteria	"OK": Communication OK, "ER": Communications error, "AL": Always
Data offsets A and B		Specifies the offset to the portion of the read data to use as the criteria. Setting range: 0000 <sub>H</sub> to FFFF <sub>H</sub>
Number of data bytes A and B		Specifies the number of bytes to use as the criteria. Setting range: 01 <sub>H</sub> to 10 <sub>H</sub>
Comparison parameters A and B	When conditions A and B are data criteria	Specifies the comparison data to use as the data criteria. (The same length as the designated number of data bytes for either ASCII and hexadecimal data.)
	When conditions A and B are "ER" communications criteria	Specifies the error code. "00000000" specifies all error codes. Example: "707A0000" specifies a Tag communications error and address error.
Operator		Operator between condition A and condition B "&&": AND, "++": OR

##### Response

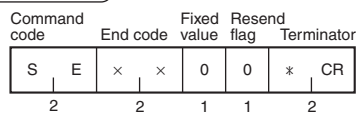

**5. Read the Output Conditions**

**Command**

Command code		Process code		Terminator	
S	E	1	0	*	CR
2		2		2	

Process code	Always "10".
--------------	--------------

**Response**

Command code		End code		Fixed value	Resend flag	Read data	Terminator
S	E	x	x	0	0	C1···;C2···;S1···;S2···;S3···;S4···;U1···;U2···	* CR
2		2		1	1	n	2

Read data	"XX" will be output for parameters that are not used for a One-channel Controller (V680-CA5D01-V2) or in Two Output Mode. If a condition is not set, " " (no setting) will be output.
-----------	---

## ▪ Setting Procedure

Always use the following procedure to set operation conditions.

### 1. Clear the operation conditions.

Command: SE20\*[CR]

Response SE0000\*[CR]

### 2. Set the command string to execute.

**Channel 1 Command String (Reads 10<sub>H</sub> bytes starting from address 0010<sub>H</sub> from channel 1 with an RA communications designation.)**

Command: SE00C1RDRAH100100010\*[CR]

Response SE0000\*[CR]

**Channel 2 Command String (No Setting)**

Command: SE00C2XX\*[CR] Note: For the V680-CA5D01-V2, this would produce a format error (end code: 14).

Response SE0000\*[CR]



CHECK!

With the V680-CA5D02-V2, always set a command string even if there is no execution command to be executed. If execution commands are not set for both channel 1 and channel 2, outputs and conditions will not be set. For the V680-CA5D01-V2, set an execution command only for channel 1.

### 3. Set the conditions.

**OUT1 Output Condition (Turn ON output OUT1 for 100 ms if the 2 bytes of data from 0000 bytes of the data read from channel 1 is greater than 1234.)**

Command: SE00S101>=00000212340100\*[CR]

Response SE0000\*[CR]

**OUT2 Output Condition (Turn ON output OUT2 for 100 ms for any error for channel 1.)**

Command: SE00S201ER000000000100\*[CR]

Response SE0000\*[CR]

**OUT3 Output Condition (No Setting)**

Command: SE00S3XX\*[CR]

**Note:** OUT3 cannot be set in Two Output Mode. An execution condition error (end code: 15) would occur.

Response SE0000\*[CR]

**OUT4 Output Condition (No Setting)**

Command: SE00S4XX\*[CR]

**Note:** OUT4 cannot be set in Two Output Mode. An execution condition error (end code: 15) would occur.

Response SE0000\*[CR]

### 4. Set the output destination.

**Channel 1 Execution Command Output Setting (Always output the execution command for channel 1 from RS-232C.)**

Command: SE00U101AL\*[CR]

Response SE0000\*[CR]

**Channel 2 Execution Command Output Setting (No Setting)**

Command: SE00U2XX\*[CR] **Note:** For the V680-CA5D01-V2, this would produce a format error (end code: 14).

Response SE0000\*[CR]



CHECK!

With the V680-CA5D02-V2, always set a command string for both channel 1 and channel 2 even if there is no execution command to be executed.

**5.** Read the operation conditions.

**Reading Operation Conditions**

Command: SE10\*[CR]

Response: SE00[C1RDRAH100100010; C2XX; S101>=00000212340100; S201ER000000000100; S3XX; S4XX; U101AL; U2XX]\*[CR]



## ■ RESPONSE RESEND (RR)

The RESPONSE RESEND command causes the ID Controller to resend the most recent response.



The RESPONSE RESEND command cannot be used to reset a response for the LARGE READ (ER) command.

### ■ 1:1 Protocol

#### Command

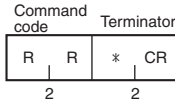

#### When There Was an Immediately Preceding Response

The ID Controller resends the most recent response, but sets the Resend Flag to “1”. The response formats are the same as for the individual commands.

#### When There Was No Immediately Preceding Response

#### Response

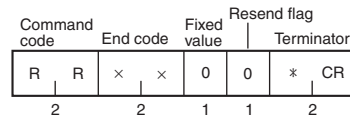

### ■ 1:N Protocol

#### Command

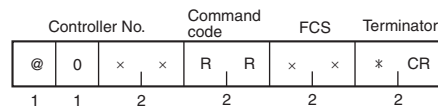

#### When There Was an Immediately Preceding Response

The ID Controller resends the most recent response, but sets the Resend Flag to “1”. The response formats are the same as for the individual commands.

#### When There Was No Immediately Preceding Response

#### Response

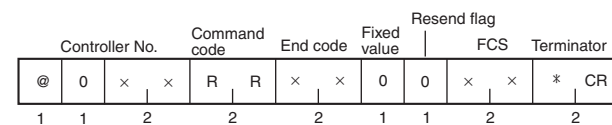

■ **CONTROLLER CONTROL (CC)**

The CONTROLLER CONTROL command is used to manipulate or read I/O.

■ **1:1 Protocol**

**Command**

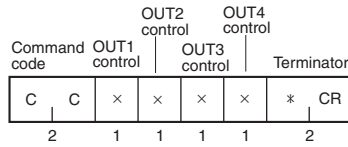

OUT1/OUT2 controls	0: Read 1: Turn ON 2: Turn OFF
OUT3/OUT4 controls	Output setting: Two Output Mode (BUSY, ERROR, OUT1, and OUT2) Always "0". Output setting: Four Output Mode (OUT1, OUT2, OUT3, and OUT4) 0: Read 1: Turn ON 2: Turn OFF

**Response**

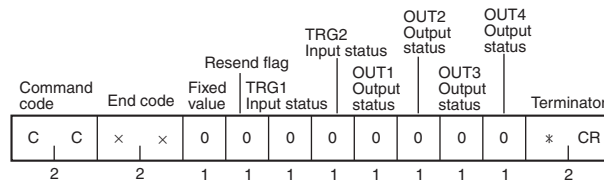

TRG1/2 Input status	The current input status 0: OFF 1: ON
OUT1/2 Output status	The output status of OUT1 and OUT2 after execution. 0: OFF 1: ON
OUT3/4 Output status	The output status of OUT3 and OUT4 after execution. • Output setting: Two Output Mode (BUSY, ERROR, OUT1, and OUT2) X: Fixed • Output setting: Four Output Mode (OUT1, OUT2, OUT3, and OUT4) 0: OFF 1: ON

1:N Protocol

Command

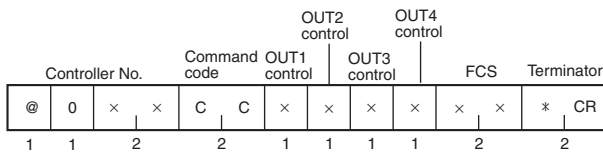

OUT1/OUT2 controls	0: Read 1: Turn ON 2: Turn OFF
OUT3/OUT4 controls	Output setting: Two Output Mode (BUSY, ERROR, OUT1, and OUT2) Always "0". Output setting: Four Output Mode (OUT1, OUT2, OUT3, and OUT4) 0: Read 1: Turn ON 2: Turn OFF

Response

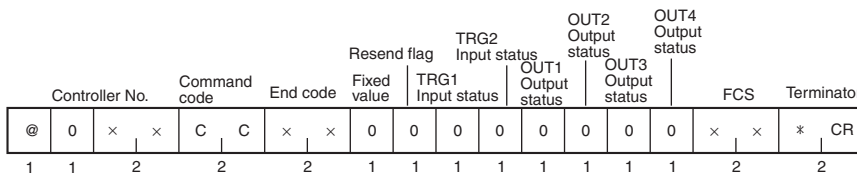

TRG1/2 Input status	The current input status 0: OFF 1: ON
OUT1/2 Output status	The output status of OUT1 and OUT2 after execution. 0: OFF 1: ON
OUT3/4 Output status	The output status of OUT3 and OUT4 after execution. • Output setting: Two Output Mode (BUSY, ERROR, OUT1, and OUT2) X: Fixed • Output setting: Four Output Mode (OUT1, OUT2, OUT3, and OUT4) 0: OFF 1: ON

■ **READ ERROR INFORMATION (CF)**

The READ ERROR INFORMATION command is used to read error log information from the Controller.

■ **1:1 Protocol**

**Command**

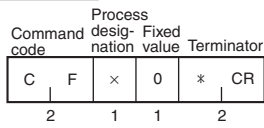

Process designation	Specifies the process to execute. "0": Read error information "1": Clear error information
---------------------	--

**Response**

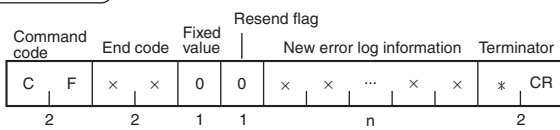

New error log information	Up to 30 records of error log information will be returned. Error log information is returned in chronological order with the newest records first. Each record is five characters long.  <pre>RD 1 70 ;</pre> <ul style="list-style-type: none"> <li>Generated end code</li> <li>Head No. with error (for communications with Data Carriers only) A space will be output for when the error is not a communications error.</li> <li>Error command</li> </ul>
---------------------------	---

**Example**

This example shows the response for when a format error occurred for a command and then a Tag communications error occurred for a READ command. Both errors occurred for Antenna 1.

**Response**

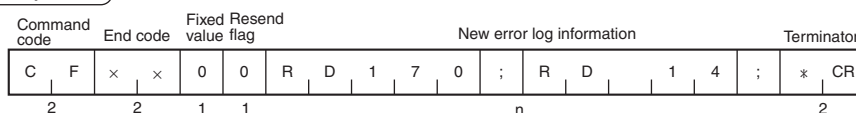

▪ 1:N Protocol

Command

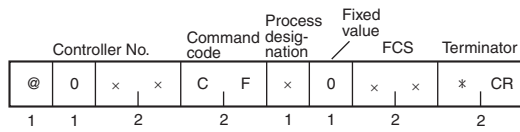

Process designation	Specifies the process to execute. "00": Read error information "01": Clear error information
---------------------	--

Response

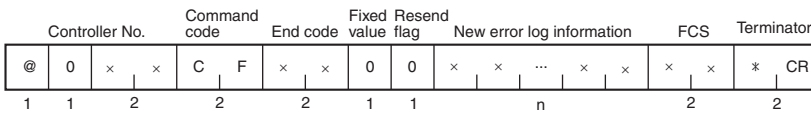

New error log information	<p>Up to 30 records of error log information will be returned. Error log information is returned in chronological order with the newest records first. Each record is five characters long.</p> <pre>RD 1 70 ;</pre> <ul style="list-style-type: none"> <li>Generated end code</li> <li>Head No. with error (for communications with Data Carriers only) A space will be output for when the error is not a communications error.</li> <li>Error command</li> </ul>
---------------------------	---

**■ READ HISTORY INFORMATION (HI)**

The READ HISTORY INFORMATION command is used to read the history information of Tag communications.

■ 1:1 Protocol

**Command**

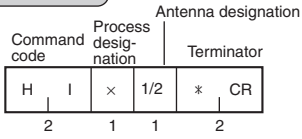

Process designation	Specifies the process to execute. "0": Read history information. "1": Clear history information.
Antenna designation	Specifies the Antenna with which to communicate. "1": Antenna 1 "2": Antenna 2



The error log information will not be cleared even if clearing the Controller history information is specified (process designation 1). Use the READ ERROR INFORMATION (CF) command to clear the error log information.

CHECK!

p. 153

**Response**

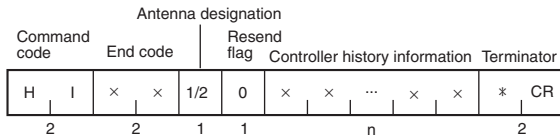

Controller history information	Up to 30 records of Controller history information will be returned. History information is returned in chronological order with the newest records first. Each record is five characters long.  <pre>RD 1 70 12 ;</pre> <ul style="list-style-type: none"> <li>— Noise level when error occurred ("00" to "99", "XX" when noise is not detected)</li> <li>— Generated end code</li> <li>— Head No. with error (for communications with Data Carriers only) A space will be output for when the error is not a communications error.</li> <li>— Error command</li> </ul>
--------------------------------	--

**Example**

This example shows the response for when an address error occurred for a READ command and then a protection error occurred for a WRITE command. Both errors occurred for Antenna 1.

**Response**

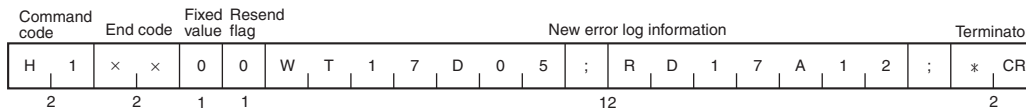

1:N Protocol

Command

Controller No.		Command code		Process designation	Fixed value	FCS		Terminator			
@	0	x	x	C	F	x	0	x	x	*	CR
1	1	2	2	1	1	2	2	2	2		

Process designation	Specifies the process to execute. "0": Read history information. "1": Clear history information.
Antenna designation	Specifies the Antenna with which to communicate. "1": Antenna 1 "2": Antenna 2



The error log information will not be cleared even if clearing the Controller history information is specified (process designation 1). Use the READ ERROR INFORMATION (CF) command to clear the error log information.

CHECK!

p. 153

Response

Controller No.		Command code		End code	Fixed value	Resend flag	New error log information				FCS		Terminator			
@	0	x	x	C	F	x	x	0	0	x	x	...	x	x	*	CR
1	1	2	2	2	1	1	n				2	2				

Controller history information	<p>Up to 30 records of Controller history information will be returned. History information is returned in chronological order with the newest records first. Each record is five characters long.</p> <pre>RD 1 70 ;        -----Generated end code        -----Head No. with error (for communications with Data Carriers only)    -----A space will be output for when the error is not a communications error.        -----Error command</pre>
--------------------------------	--

## Host Commands

### ■ TEST Command (TS)

The TEST command is used to test communications between the host device and ID Controller. The TEST command is used to send a text message from the host device to the ID Controller. The ID Controller returns the same text message unaltered.

### ■ 1:1 Protocol

#### Command

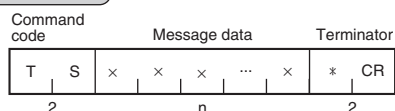

Message data	Any text string to use to text communications. Number of characters: 262 max.
--------------	--

#### Response

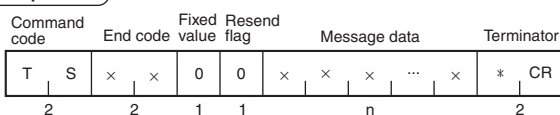

### ■ 1:N Protocol

#### Command

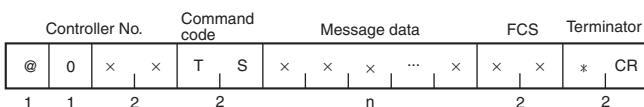

Message data	Any text string to use to text communications. Number of characters: 262 max.
--------------	--

#### Response

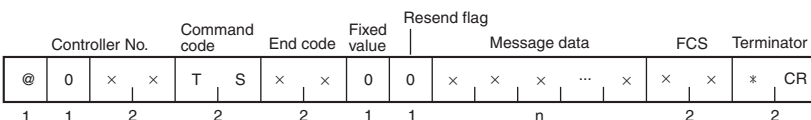



■ VERSION READ (VS)

The VERSION READ command is used to read the Controller's software model, software version, and software creation date.

■ 1:1 Protocol

Command

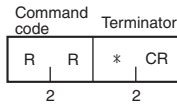

Response

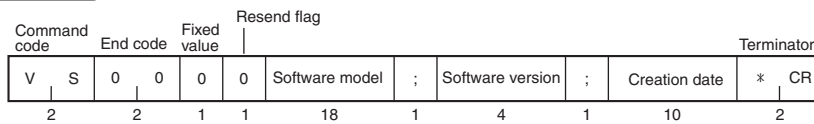

Software model	The software model. V680-CA5D0*\$000000
Software version	The software version. *.*
Software creation date	The software creation date. 20**/**/**

■ 1:N Protocol

Command

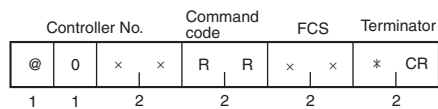

Response

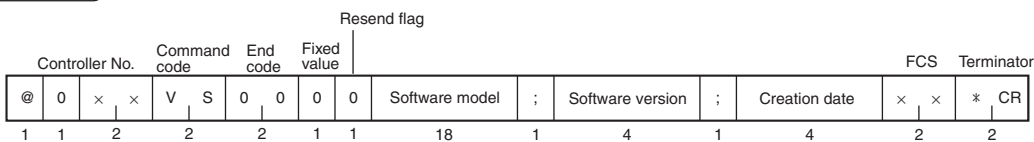

Software model	The software model. V680-CA5D0*\$000000
Software version	The software version. *.*
Software creation date	The software creation date. 20**/**/**

## Evaluation Command

### ■ NOISE DETECTION (NS)

The NOISE DETECTION command is used to check the noise level when the command is received.



CHECK!

This Command cannot be used when the V680-H01 Antenna is connected.

#### ■ 1:1 Protocol

##### Command

Command code		Fixed value	Antenna designation		Terminator
N	S	0	1/2	*	CR
2	1	1	2	2	

Fixed value	Always "0".
Antenna designation	Specifies the Antenna with which to communicate. "1": Antenna 1 "2": Antenna 2

##### Response

Command code		End code		Resend flag		Antenna designation		Average noise level		Maximum noise level		Minimum noise level		Terminator	
N	S	x	x	1/2	0	x	x	x	x	x	x	*	CR		
2		2	2	1	1	2	2	2	2	2	2	2	2		

Average noise level	Gives the average noise level that was measured. "00" to "99"
Maximum noise level	Gives the maximum noise level that was measured. "00" to "99"
Minimum noise level	Gives the minimum noise level that was measured. "00" to "99"

▪ 1:N Protocol

Command

Controller No.		Command code		Fixed value	Antenna designation		FCS		Terminator		
@	0	x	x	N	S	0	1/2	x	x	*	CR
1	1	2	2	1	1	2	2	2	2		

Fixed value	Always "0".
Antenna designation	Specifies the Antenna with which to communicate. "1": Antenna 1 "2": Antenna 2

Response

Controller No.		Command code		End code		Antenna designation	Resend flag	Average noise level		Maximum noise level		Minimum noise level		FCS		Terminator		
@	0	x	x	N	S	x	x	1/2	0	x	x	x	x	x	x	x	*	CR
1	1	2	2	2	2	1	1	2	2	2	2	2	2	2	2	2		

Average noise level	Gives the average noise level that was measured. "00" to "99"
Maximum noise level	Gives the maximum noise level that was measured. "00" to "99"
Minimum noise level	Gives the minimum noise level that was measured. "00" to "99"

## Other Command Codes

### ■ UNDEFINED COMMAND RESPONSE (IC)

If the ID Controller receives a command code that it cannot interpret, it will return a response for the undefined command.

#### ■ 1:1 Protocol

##### Response

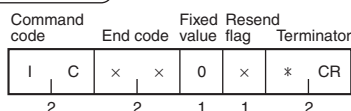

#### ■ 1:N Protocol

##### Response

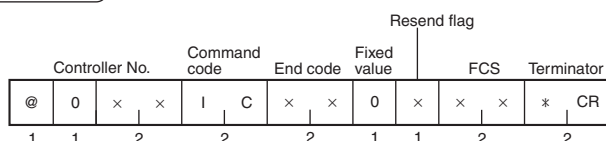

### ■ Error Response

If an error occurs during communications with the host device or the Tag, error information is provided in the end code.

#### ■ 1:1 Protocol

##### Response

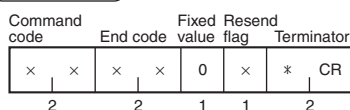

#### ■ 1:N Protocol

##### Response

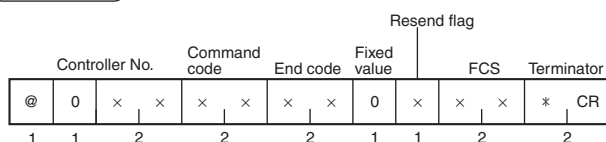

## List of End Codes

End codes are expressed in 2-digit hexadecimal.

Classification	End code	Name
Normal end	00	Normal end
		Command processing terminated.
		Polling command query (after communications with Tag were completed normally)
		Polling command cancelled.
		Normal end (no error) for DATA CHECK command or OVERWRITE COUNT CONTROL command
	01	Polling command received.
Host communications error	02	Polling command query (no results information)
	03	Multi-access communications ended
	10	Parity error
	11	Framing error
	12	Overrun error
	13	FCS error
Tag communications error	14	Format error
	15	Execution condition error
	18	Frame length error
	70	Tag communications error
	71	Mismatch error
	72	Tag missing error
	76	Error end (verification error or overwrite count exceeded) for DATA CHECK command, OVERWRITE COUNT CONTROL command or Data check error in READ TAG MEMORY ERROR CORRECTION command
	77	Data check warning in READ TAG MEMORY ERROR CORRECTION command
	79	Tag error
	7A	Address error
System error	7C	Antenna not connected error
	7D	Write protected error
	92	Antenna internal power supply voltage error
	93	Internal memory error
	9C	Number of Antennas error
Former Antenna setting error		



Refer to *Error Lists* for details on error checks.

CHECK!



p. 240

# V600 Commands

## Read/Write Functions

### Read/Write Command Processing

The normal (not auto) read/write functions are used for communications with Tags within a fixed area. Therefore, check that the Tag is within the Antenna's communications area before sending read/write commands. If a Tag is not present, a Tag missing error response will be returned.

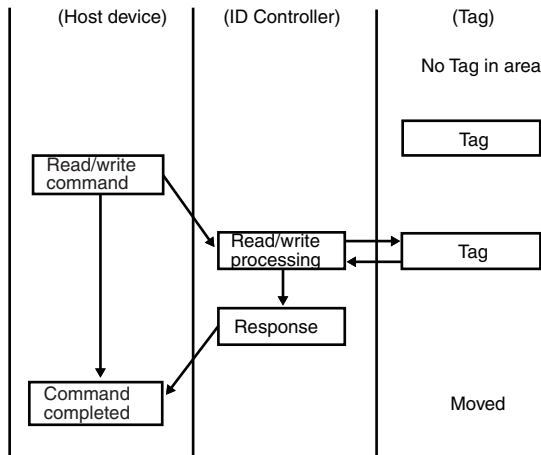

1. Confirm that the Tag is within the communications area before sending the command from the host device.
2. The ID Controller performs read or write processing according to the command.
3. After processing has been completed, the ID Controller returns a processing completed response to the host device. The host device receives the response and then moves the workpiece (with Tag) along the production line.

## Auto Read/Write Functions

### Auto Command Processing

The ID Controller does not return a response for AUTO commands until a Tag is within range. The communications path with the host device is busy during this time.

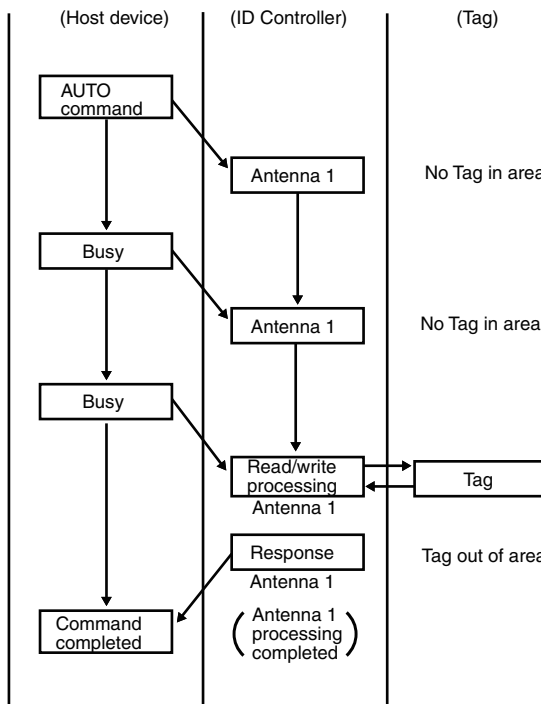

1. An AUTO command is sent for an Antenna from the host device.
2. The ID Controller does not return a response while the Tag is not in range, so the host device is in busy status.
3. Read or write processing is performed when the Tag passes in front of the Antenna.
4. After processing has been completed, the ID Controller sends a processing completed response for the AUTO command to the host device.

## Using AUTO READ/AUTO WRITE Commands

Normally, read/write commands are used when a Tag is in the communications area. The AUTO READ and AUTO WRITE commands are used for moving Tags.

### ● READ or WRITE Command

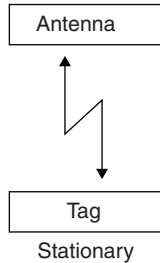

- Communications are more reliable because a greater communications distance is possible compared to a moving Tag.

### ● AUTO READ or AUTO WRITE Command

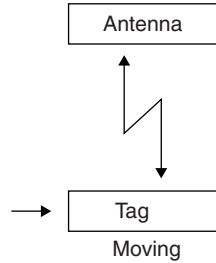

- If an AUTO command is used, approaching Tags can be detected automatically.
- If the Tag speed is slow and positioning is accurate, the communications distance is restricted only minimally.

### ● Command Application

Item	Application method	Description	Precautions
Sending commands using a timer	<p>The next AUTO command is set when a response to the previous command is received.</p>	<ul style="list-style-type: none"> <li>• A timer can be used effectively when Tags pass through the Antenna's communication area at a fixed cycle.</li> <li>• A timer can be used effectively when time is required until the next Tag arrives.</li> <li>• A timer can be used to prevent repeating the same communication with the same Tag by waiting for the Tag to leave the communications area after the communication has been completed.</li> </ul>	<ul style="list-style-type: none"> <li>• The Tag speed must be consistent.</li> <li>• Application is possible only when communicating more than once with the same Tag is not required.</li> </ul>
Trigger	<p>The next AUTO command is set when a trigger is received after receiving a response to the previous command.</p>	<ul style="list-style-type: none"> <li>• A trigger can be used effectively, for example, when it is necessary to confirm the completion of a previous process before sending the AUTO command.</li> <li>• The trigger must be received before the next Tag approaches.</li> </ul>	<ul style="list-style-type: none"> <li>• Trigger processing is required.</li> </ul>

## Polling Function

This section describes command processing when two Antennas are connected to one ID Controller. With normal AUTO commands, the ID Controller does not return a response while the Tag is not in range, i.e., the communications path with the host device is busy and the host device cannot send a command to the other Antenna connected to the same ID Controller.

With a POLLING AUTO command, however, the ID Controller returns a response only when a request is received from the host device. Therefore, the communications path does not continue to remain in busy status and the host device can send a command to the other Antenna connected to the same ID Controller.

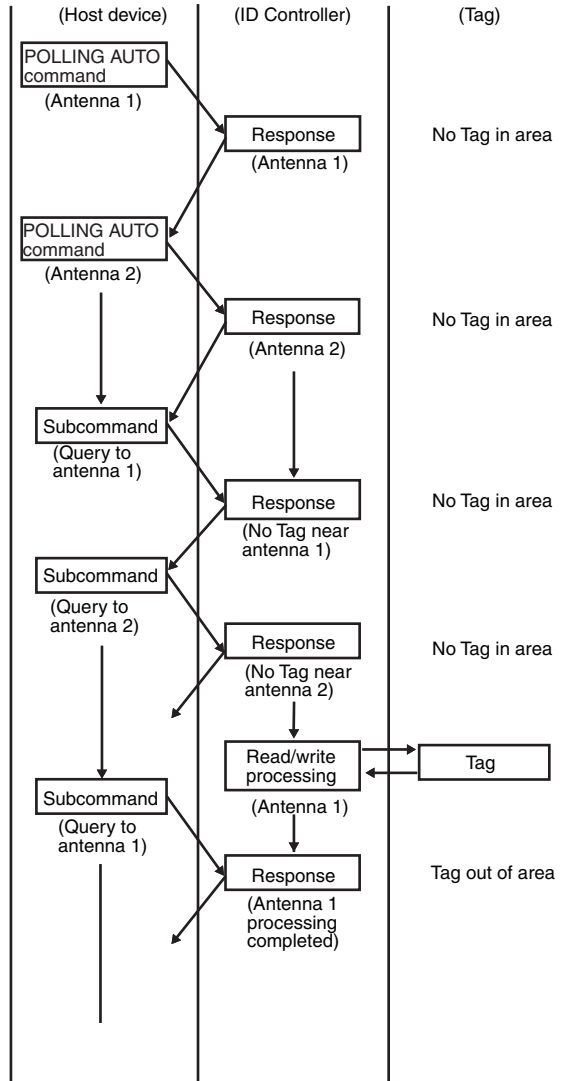

1. A POLLING AUTO command is sent to Antenna 1.
2. After receiving the command, the ID Controller immediately returns a response indicating that the command was received.
3. A POLLING AUTO command is sent to Antenna 2.
4. After receiving the command, the ID Controller immediately returns a response indicating that the command was received.
5. The host device can send subcommands to query processing status, or abort polling auto processing.
6. If the Tag is not in range, an out-of-range response will be returned for the query subcommand.
7. Read or write processing is performed when the Tag passes in front of the Read/Write Antenna.
8. After processing has been completed, the ID Controller returns a response with the processing results for Antenna 1 to the host device for the query subcommand.



## Command and Response Formats

### 1:1 Protocol

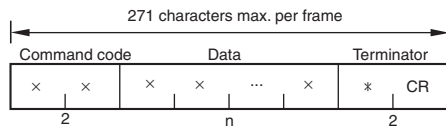

### 1:N Protocol

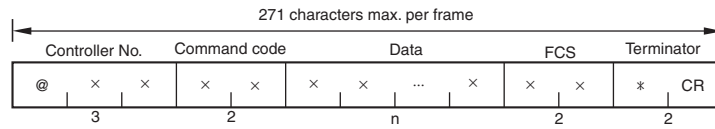

The Controller No. is given as a decimal number between 00 and 31.

CHECK!

Name	Description
Controller No.	The Controller number (00 to 31) is included only for 1:N protocol. The Controller number must be preceded by the @ mark and is specified as a decimal value.
Command code	A 2-character code that specifies the command to be executed is added. The same command code is returned in the response.
Data	Command and response information is entered here. <ul style="list-style-type: none"> <li>• ASCII/Hexadecimal designation, process designation, and mode designation</li> <li>• Destination Antenna designation</li> <li>• Start address</li> <li>• Write data or number of read bytes</li> </ul>
FCS (See note.)	Horizontal parity check data that is added when using 1:N protocol.
Terminator	Indicates the end of the command or response.

**Note:** Refer to FCS Calculation Example for details on calculation programs for the FCS.



p. 177

## Command List

Commands can be classified into three major types.

### ■ Commands for Tag Communications

The following commands are used to communicate with Tags.

Command code	Name	Description	Page
RD	READ	Reads memory data from the Tag.	p. 178
WT	WRITE	Writes data to the memory of the Tag.	p. 180
XR	EXPANSION READ	Reads up to 2 KB of data from the Tag by dividing the response into frames.	p. 182
XW	EXPANSION WRITE	Writes up to 2 KB of data from the Tag by dividing the command into frames.	p. 186
ER	LARGE READ	Reads up to 8 KB of data from a Tag.	p. 190
AR	AUTO READ	Reads data from Tag memory when the Tag approaches.	p. 194
AW	AUTO WRITE	Writes data to Tag memory when the Tag approaches.	p. 196
DF	DATA FILL	Writes the specified data to the specified number of bytes beginning from the specified start address.	p. 198
AF	AUTO DATA FILL	Writes the specified data to the specified number of bytes beginning from the specified start address when the Tag approaches.	p. 201
CP	COPY	Reads data from the memory of a Tag using one Antenna and writes it to the memory of the Tag in the other Antenna's communications area.	p. 203
AP	AUTO COPY	Waits for Tags to approach and then reads data from the memory of a Tag using one Antenna and writes it to the memory of the Tag in the other Antenna's communications area.	p. 205
PR	POLLING AUTO READ	Reads data from Tag memory when the Tag approaches. The processing results can be queried later using a subcommand.	p. 207
PW	POLLING AUTO WRITE	Writes data to Tag memory when the Tag approaches. The processing results can be queried later using a subcommand.	p. 211
MD C/K	DATA CHECK	Checks the memory check code in the Tag.	p. 215
MD S/L	OVERWRITE COUNT CONTROL	Used to manage the number of times data is written to a Tag.	p. 217
RP	WRITE REPEAT	Executes the most recently executed write command again.	p. 219

### ■ Communications Subcommands

The following commands are used to cancel command execution.

Command code	Name	Description	Page
AA	COMMAND PROCESSING TERMINATE	Forcefully ends communications with a Tag.	p. 221
XZ	ABORT	Resets the ID Controller to the status entered immediately after turning ON the power supply. The ID Controller does not send a response. Do not use the ABORT command while the ID Controller is communicating with a Tag.	p. 222

## Host Commands

The following commands are used to control the ID Controller.

Command code	Name	Description	Page
TS	TEST	Checks the communications conditions between the ID Controller and host device. The data sent by the host device is returned by the ID Controller without modification.	p. 223
CC	CONTROLLER CONTROL	Controls ID Controller I/O.	p. 224
CF	READ ERROR INFORMATION	Reads the error log.	p. 226
TR	COMMUNICATIONS SET	Sets serial communications parameters for communicating with the host device.	p. 228
SP	PARAMETER SET	Sets, reads, or initializes ID Controller parameters.	p. 230

## FCS Calculation Example

### Reading 5 Bytes Started from Address 0010<sub>H</sub>

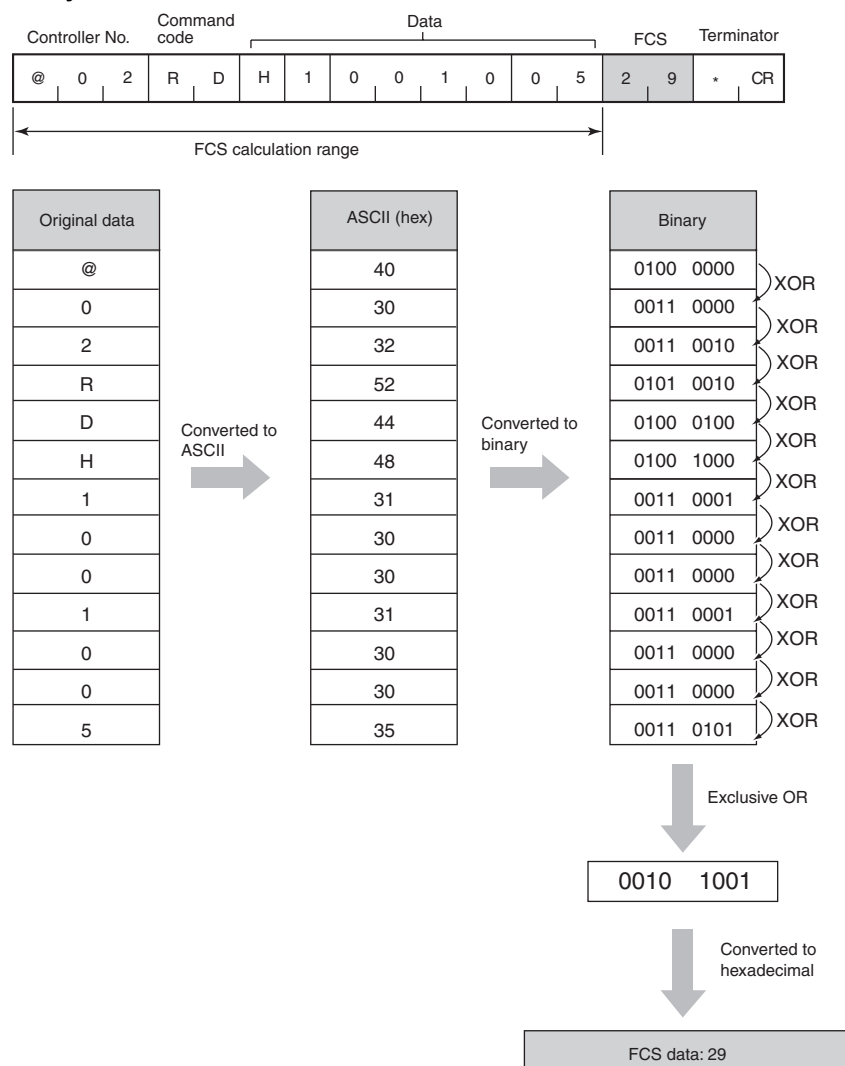

## Commands for Tag Communications

This section describes the commands that are used to communicate with Tags.

### ■ READ (RD)

The READ command reads data from a Tag. If there is no Tag in the communications area, the ID Controller will return an error response with an error code of 72 (Tag missing error).

#### ■ 1:1 Protocol

##### Command

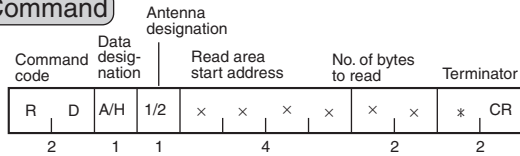

Data designation	Specifies the code format when sending the read data response. “A”: ASCII “H”: Hexadecimal
Antenna designation	Specifies the Antenna with which to communicate. “1”: Antenna 1 “2”: Antenna 2
Read area start address	Specifies the start address of the area in the Tag from which data is to be read from in 4-digit hexadecimal. Setting range: 0000H to FFFFH
No. of bytes to read	Specifies the number of bytes of data to read from the Tag in 2-digit hexadecimal. Up to 256 bytes can be read with one command. Setting range: 00H to FF (Specify 00H for 256 bytes.) • ASCII: 256 bytes (256 characters) • Hexadecimal: 256 bytes (512 characters)

##### Response

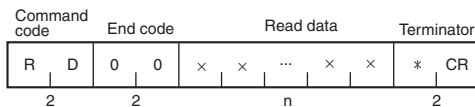

End code	Indicates the execution result for the command. “00” indicates a normal end.  Refer to List of End Codes for information on other end codes.  p. 235
Read data	The data read from the Tag. The number of characters will be the same as the specified number of bytes to read for ASCII data and twice that number for hexadecimal data.

1:N Protocol

Command

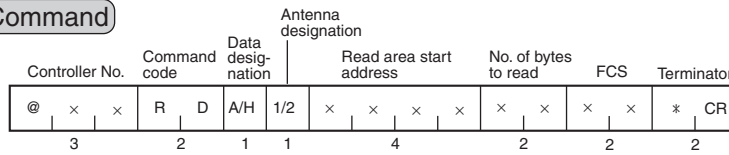

Data designation	Specifies the code format when sending the read data response. “A”: ASCII “H”: Hexadecimal
Antenna designation	Specifies the Antenna with which to communicate. “1”: Antenna 1 “2”: Antenna 2
Read area start address	Specifies the start address of the area in the Tag from which data is to be read from in 4-digit hexadecimal. Setting range: 0000H to FFFFH
No. of bytes to read	Specifies the number of bytes of data to read from the Tag in 2-digit hexadecimal. Up to 256 bytes can be read with one command. • ASCII: 256 bytes (256 characters) • Hexadecimal: 256 bytes (512 characters) Setting range: 00H to FFH (Specify 00H for 256 bytes.)

Response

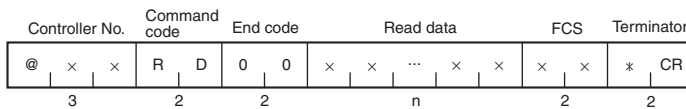

End code	Indicates the execution result for the command. “00” indicates a normal end.  Refer to List of End Codes for information on other end codes.  p. 235
Read data	The data read from the Tag. The number of characters will be the same as the specified number of bytes to read for ASCII data and twice that number for hexadecimal data.

■ WRITE (WT)

The WRITE command writes data to a Tag. If there is no Tag in the communications area, the ID Controller will return an error response with an error code of 72 (Tag missing error).

■ 1:1 Protocol

Command

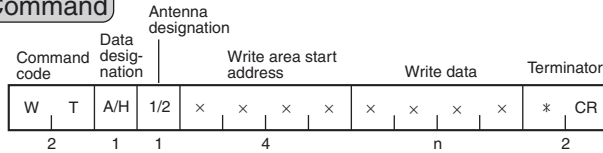

Data designation	Specifies the code format when sending the Tag write data. “A”: ASCII “H”: Hexadecimal
Antenna designation	Specifies the Antenna with which to communicate. “1”: Antenna 1 “2”: Antenna 2
Write area start address	Specifies the start address of the area in the Tag to which data is to be written in 4-digit hexadecimal. Setting range: 0000H to FFFFH
Write data	Specifies the data to be written to the Tag. Up to 256 bytes can be written with one command. <ul style="list-style-type: none"> <li>• ASCII: 256 bytes (256 characters)</li> <li>• Hexadecimal: 256 bytes (512 characters)</li> </ul> <b>Note:</b> When hexadecimal is designated, set two characters for each byte.

Response

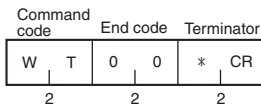

End code	Indicates the execution result for the command. “00” indicates a normal end.  Refer to List of End Codes for information on other end codes.  p. 235
----------	---

■ 1:N Protocol

Command

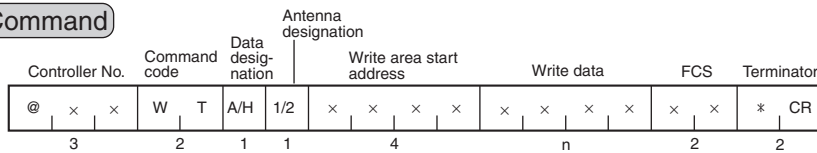

Data designation	Specifies the code format when sending the Tag write data. “A”: ASCII “H”: Hexadecimal
Antenna designation	Specifies the Antenna with which to communicate. “1”: Antenna 1 “2”: Antenna 2
Write area start address	Specifies the start address of the area in the Tag to which data is to be written in 4-digit hexadecimal. Setting range: 0000H to FFFFH
Write data	Specified the data to be written to the Tag. Up to 256 bytes can be written with one command. <ul style="list-style-type: none"> <li>• ASCII: 256 bytes (256 characters)</li> <li>• Hexadecimal: 256 bytes (512 characters)</li> </ul> <b>Note:</b> When hexadecimal is designated, set two characters for each byte.

Response

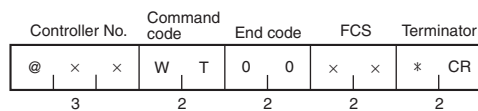

End code	Indicates the execution result for the command. “00” indicates a normal end.  Refer to List of End Codes for information on other end codes.  p. 235
----------	---

■ **EXPANSION READ (XR)**

The EXPANSION READ command reads up to 2 KB of data from a Tag by dividing the response into frames. If there is no Tag in the communications area, the ID Controller will return an error response with an error code of 72 (Tag missing error).

The host device cannot send another command to the ID Controller until all response frames have been received. (Excluding the AA command and XZ command.)

■ **1:1 Protocol**

**Command**

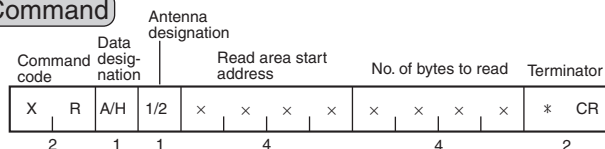

Data designation	Specifies the code format when sending the read data response. “A”: ASCII “H”: Hexadecimal
Antenna designation	Specifies the Antenna with which to communicate. “1”: Antenna 1 “2”: Antenna 2
Read area start address	Specifies the start address of the area in the Tag from which data is to be read from in 4-digit hexadecimal. Setting range: 0000H to FFFFH
No. of bytes to read	Specifies the number of bytes to read from the Tag in 4-digit hexadecimal. Up to 2,048 bytes can be read with one command. Setting range: 0001H to 0800H <ul style="list-style-type: none"> <li>• 1000 Byte Tags (V680-D1KP□□) <ul style="list-style-type: none"> <li>ASCII: 1000 bytes (1000 characters)</li> <li>Hexadecimal: 1000 bytes (2000 characters)</li> </ul> </li> <li>• 2000 Byte Tags (V680-D2KF□□) <ul style="list-style-type: none"> <li>ASCII: 2000 bytes (2000 characters)</li> <li>Hexadecimal: 2000 bytes (4000 characters)</li> </ul> </li> <li>• 8-/32-KB Tags (V680-D8KF68/-D32KF68) <ul style="list-style-type: none"> <li>ASCII: 2048 bytes (2048 characters)</li> <li>Hexadecimal: 2048 bytes (4096 characters)</li> </ul> </li> </ul>

**Response**

**Responses with 256 or Fewer Characters**

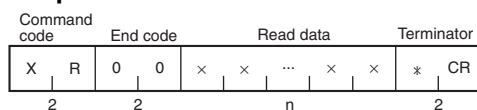

End code	Indicates the execution result for the command. “00” indicates a normal end.  Refer to List of End Codes for information on other end codes.  p. 235
Read data	The data read from the Tag. The number of characters will be the same as the specified number of bytes to read for ASCII data and twice that number for hexadecimal data.



### Responses Longer Than 256 Characters

If the response containing the read data is longer than 256 characters, the response is divided into multiple frames as shown below. Only the final response frame ends in a terminator (\*CR). All other frames end in a delimiter (CR).

When the ID Controller sends any response frame except for the last one, it will wait for the host device to return a delimiter (CR). When the ID Controller receives the delimiter, it will send the next response frame.

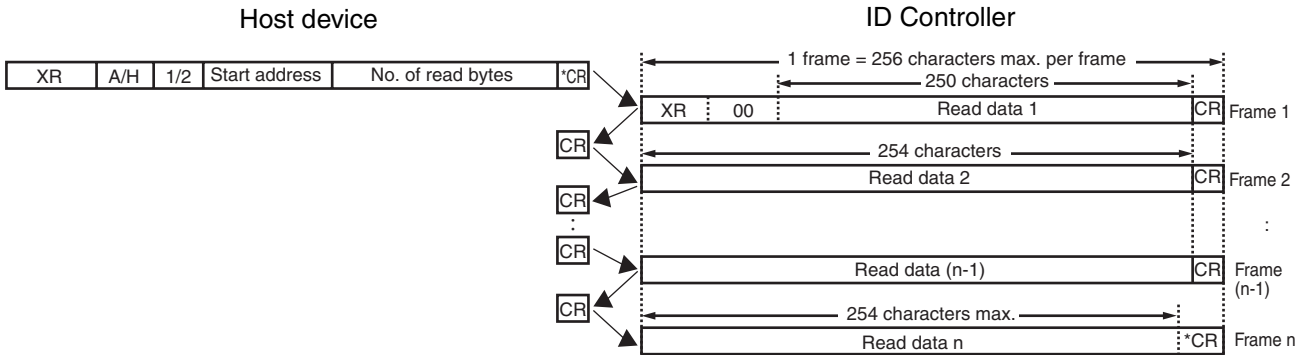

▪ **1:N Protocol**

**Command**

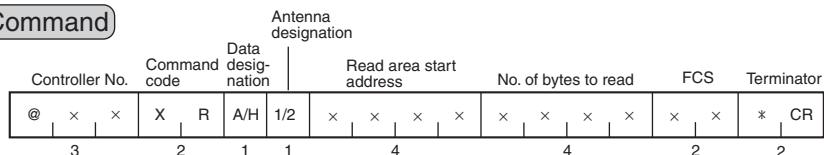

Data designation	Specifies the code format when sending the read data response. “A”: ASCII “H”: Hexadecimal
Antenna designation	Specifies the Antenna with which to communicate. “1”: Antenna 1 “2”: Antenna 2
Read area start address	Specifies the start address of the area in the Tag from which data is to be read from in 4-digit hexadecimal. Setting range: 0000H to FFFFH
No. of bytes to read	Specifies the number of bytes to read from the Tag in 4-digit hexadecimal. Up to 2,048 bytes can be read with one command. Setting range: 0001H to 0800H <ul style="list-style-type: none"> <li>• 1000 Byte Tags (V680-D1KP□□) <ul style="list-style-type: none"> <li>ASCII: 1000 bytes (1000 characters)</li> <li>Hexadecimal: 1000 bytes (2000 characters)</li> </ul> </li> <li>• 8-/32-KB Tags (V680-D8KF68/-D32KF68) <ul style="list-style-type: none"> <li>ASCII: 2048 bytes (2048 characters)</li> <li>Hexadecimal: 2048 bytes (4096 characters)</li> </ul> </li> <li>• 2000 Byte Tags (V680-D2KF□□) <ul style="list-style-type: none"> <li>ASCII: 2000 bytes (2000 characters)</li> <li>Hexadecimal: 2000 bytes (4000 characters)</li> </ul> </li> </ul>

**Response**

**Responses with 256 or Fewer Characters**

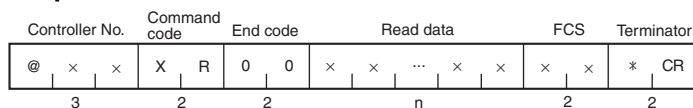

End code	Indicates the execution result for the command. “00” indicates a normal end.  Refer to List of End Codes for information on other end codes.  p. 235
Read data	The data read from the Tag. The number of characters will be the same as the specified number of bytes to read for ASCII data and twice that number for hexadecimal data.

### Responses Longer Than 256 Characters

If the response containing the read data is longer than 256 characters, the response is divided into multiple frames as shown below. Only the final response frame ends in a terminator (\*CR). All other frames end in a delimiter (CR). When the ID Controller sends any response frame except for the last one, it will wait for the host device to return a delimiter (CR). When the ID Controller receives the delimiter, it will send the next response frame.

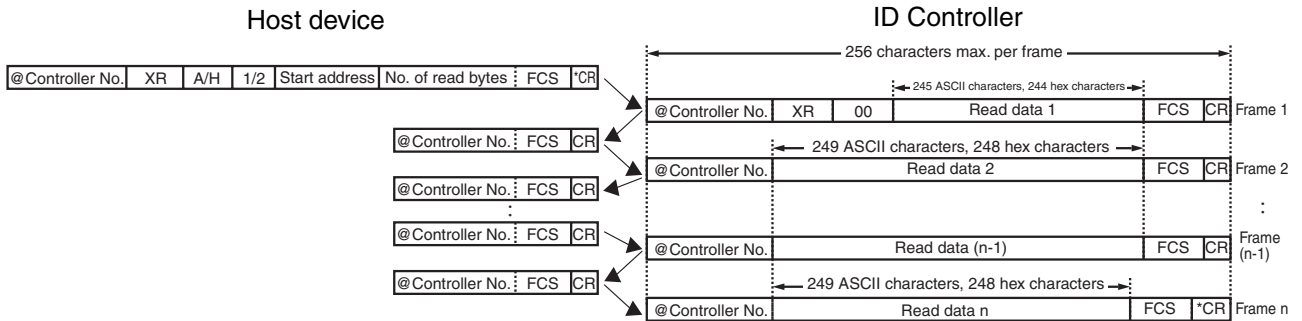

■ **EXPANSION WRITE (XW)**

The EXPANSION WRITE command writes up to 2 KB of data to a Tag by dividing the command into frames. If there is no Tag in the communications area, the ID Controller will return an error response with an error code of 72 (Tag missing error).

The host device cannot send another command to the ID Controller until all response frames have been received. (Excluding the AA command and XZ command.).

■ **1:1 Protocol**

**Command**

**First Frame**

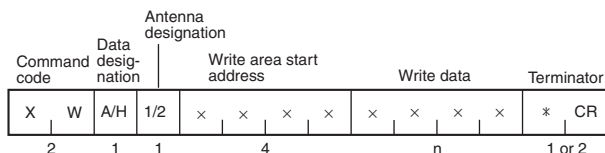

Data designation	Specifies the code format for sending the write data to the Tag. “A”: ASCII “H”: Hexadecimal
Antenna designation	Specifies the Antenna with which to communicate. “1”: Antenna 1 “2”: Antenna 2
Write area start address	Specifies the start address of the area from which data is to be written in 4-digit hexadecimal. Setting range: 0000H to FFFFH
Write data	Specified the data to be written to the Tag. Number of characters: 1 to 257
Delimiter	CR: Indicates the end of the frame when there is another frame.
Terminator	*CR: Indicates the end of the frame when there is not another frame.

**All Other Frames**

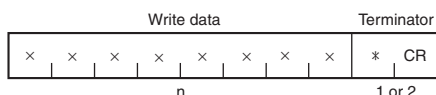

Write data	Specified the data to be written to the Tag. Number of characters: 0 to 265
Delimiter	CR: Indicates the end of the frame when there is another frame.
Terminator	*CR: Indicates the end of the frame when there is not another frame.

Response

Command code		End code		Terminator	
X	W	0	0	*	CR
2		2		2	

End code	<p>Indicates the execution result for the command. “00” indicates a normal end.</p> <p>Refer to List of End Codes for information on other end codes.   p. 235</p>
----------	---

▪ Dividing Frames

If the command length is longer than 271 characters, divide the command into separate frames before sending the command.

When the ID Controller receives any frame except for the last frame, it will return a delimiter (CR) to the host device, indicating that the ID Controller is ready to accept the next command frame.

**Method for Dividing Frames**

1. Divide the command into frames with 271 or fewer characters each.
2. Attach the terminator (\*CR) to the last frame (frame n) only. Attach the delimiter (CR) to the end of all other frames.
3. Be sure to include the command code, data designation, antenna designation, and start address in the first frame (frame 1). If any of these parameters is omitted, a command input error will occur. Write data does not have to be included in the first frame.
4. Make sure that data is divided correctly without any single frames containing only AA\*CR or XZ\*CR (i.e., “@Controller No., AA, FCS,\*CR” or “@Controller No., XZ, FCS,\*CR”).

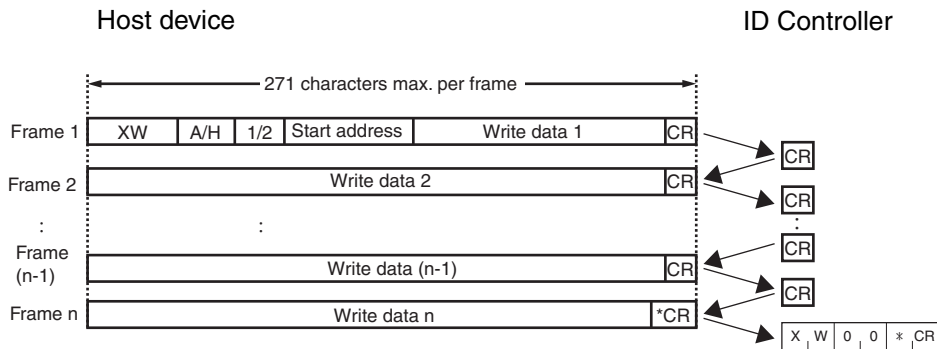

▪ 1:N Protocol

Command

**First Frame**

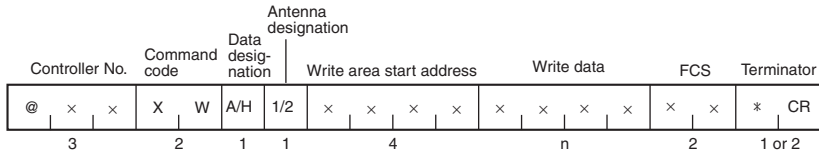

Data designation	Specifies the code format for sending the write data to the Tag. “A”: ASCII “H”: Hexadecimal
Antenna designation	Specifies the Antenna with which to communicate. “1”: Antenna 1 “2”: Antenna 2
Write area start address	Specifies the start address of the area from which data is to be written in 4-digit Setting range: 0000H to FFFFH
Write data	Specified the data to be written to the Tag. Number of characters: 1 to 257
Delimiter	CR: Indicates the end of the frame when there is another frame.
Terminator	*CR: Indicates the end of the frame when there is not another frame.

**All Other Frames**

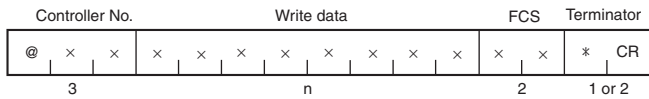

Write data	Specified the data to be written to the Tag. Number of characters: 0 to 265
Delimiter	CR: Indicates the end of the frame when there is another frame.
Terminator	*CR: Indicates the end of the frame when there is not another frame.

Response

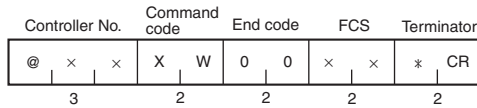

End code	<p>Indicates the execution result for the command. "00" indicates a normal end.</p> <p>Refer to List of End Codes for information on other end codes.  p. 235</p>
----------	--

▪ Dividing Frames

If the command length is longer than 271 characters, divide the command into separate frames before sending the command

When the ID Controller receives any frame except for the last frame, it will return a delimiter (CR) to the host device, indicating that the ID Controller is ready to accept the next command frame.

**Method for Dividing Frames**

1. Divide the command into frames with 271 or fewer characters each.
2. Attach the terminator (\* CR) to the last frame (frame n) only. Attach the delimiter (CR) to the end of all other frames.
3. Be sure to include the command code, data designation, antenna designation, and start address in the first frame (frame 1). If any of these parameters is omitted, a command input error will occur.  
Write data does not have to be included in the first frame
4. Make sure that data is divided correctly without any single frames containing only AA\*CR or XZ\*CR (i.e., "@Controller No., AA, FCS,\*CR" or "@Controller No., XZ, FCS,\*CR").
5. Be sure to include the Controller number and FCS in all frames.

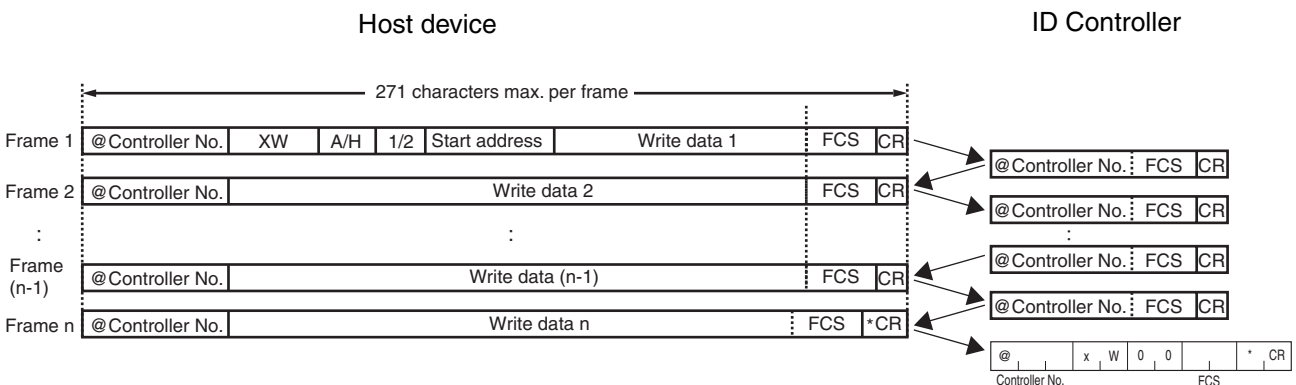

■ **LARGE READ (ER)**

The LARGE READ command reads up to 8 KB of data from a Tag. If there is no Tag, the ID Controller returns an error response with an error code of 72 (Tag missing error).

■ **1:1 Protocol**

**Command**

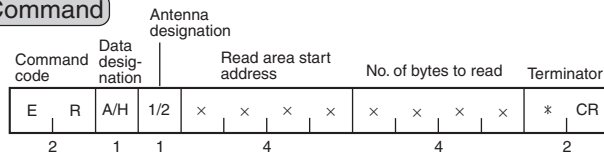

Data designation	Specifies the code format when sending the read data response. “A”: ASCII “H”: Hexadecimal
Antenna designation	Specifies the Antenna with which to communicate. “1”: Antenna 1 “2”: Antenna 2
Read area start address	Specifies the start address of the area in the Tag from which data is to be read from in 4-digit hexadecimal. Setting range: 0000H to FFFFH
No. of bytes to read	Specifies the number of bytes to read from the Tag in 4-digit hexadecimal. Up to 8,192 bytes can be read with one command. Setting range: 0001H to 2000H <ul style="list-style-type: none"> <li>• 1000 Byte Tags (V680-D1KP□□) <ul style="list-style-type: none"> <li>ASCII: 1000 bytes (1000 characters)</li> <li>Hexadecimal: 1000 bytes (2000 characters)</li> </ul> </li> <li>• 8-/32-KB Tags (V680-D8KF68/-D32KF68) <ul style="list-style-type: none"> <li>ASCII: 8192 bytes (8192 characters)</li> <li>Hexadecimal: 8192 bytes (16384 characters)</li> </ul> </li> <li>• 2000 Byte Tags (V680-D2KF□□) <ul style="list-style-type: none"> <li>ASCII: 2000 bytes (2000 characters)</li> <li>Hexadecimal: 2000 bytes (4000 characters)</li> </ul> </li> </ul>

**Response**

**Responses of 245 Characters or Fewer**

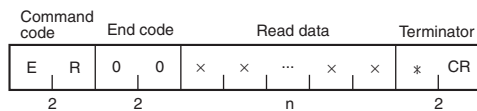

SECTION 5 V600 Commands





### Responses Longer Than 245 Characters

If the response containing the read data is longer than 245 characters, the response is divided into multiple frames as shown below. Only the final response frame ends in a terminator (\*CR). All other frames end in a delimiter (CR).

By default, each response frame is separated by 20 ms. The interval between frames can be changed using the PARAMETER SET (SP) command.

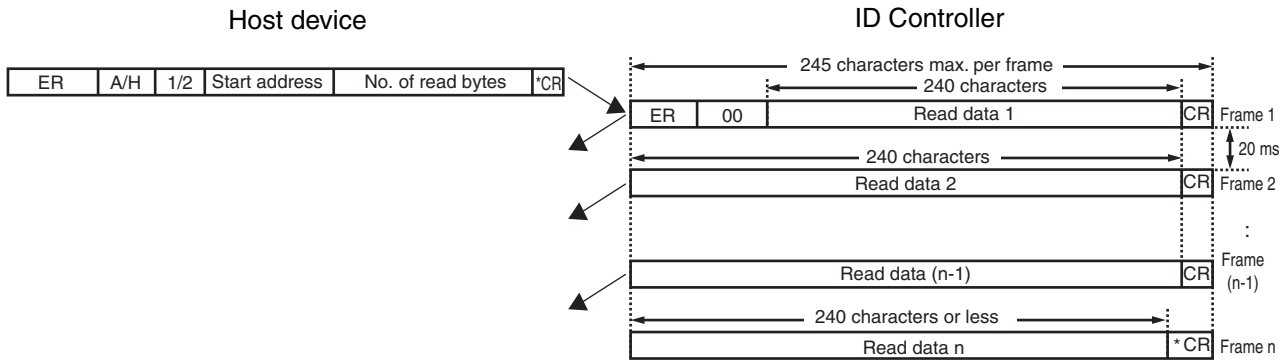
 p. 230



End code	<p>Indicates the execution result for the command. "00" indicates a normal end.</p> <p>Refer to List of End Codes for information on other end codes.</p> <p> p. 235</p>
Read data	<p>The data read from the Tag.</p> <p>The number of characters will be the same as the specified number of bytes to read for ASCII data and twice that number for hexadecimal data.</p>

▪ **1:N Protocol**

**Command**

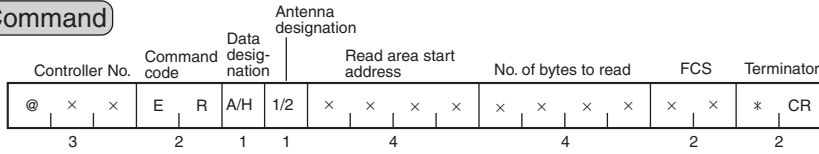

Data designation	Specifies the code format when sending the read data response. “A”: ASCII “H”: Hexadecimal
Antenna designation	Specifies the Antenna with which to communicate. “1”: Antenna 1 “2”: Antenna 2
Read area start address	Specifies the start address of the area in the Tag from which data is to be read from in 4-digit hexadecimal. Setting range: 0000H to FFFFH
No. of bytes to read	Specifies the number of bytes to read from the Tag in 4-digit hexadecimal. Up to 8,192 bytes can be read with one command. Setting range: 0001H to 2000H <ul style="list-style-type: none"> <li>• 1000 Byte Tags (V680-D1KP□□) <ul style="list-style-type: none"> <li>ASCII: 1000 bytes (1000 characters)</li> <li>Hexadecimal: 1000 bytes (2000 characters)</li> </ul> </li> <li>• 8-/32-KB Tags (V680-D8KF68/-D32KF68) <ul style="list-style-type: none"> <li>ASCII: 8192 bytes (8192 characters)</li> <li>Hexadecimal: 8192 bytes (16384 characters)</li> </ul> </li> <li>• 2000 Byte Tags (V680-D2KF□□) <ul style="list-style-type: none"> <li>ASCII: 2000 bytes (2000 characters)</li> <li>Hexadecimal: 2000 bytes (4000 characters)</li> </ul> </li> </ul>

**Response**

**Responses of 250 Characters or Fewer**

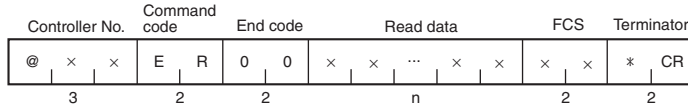



### Responses Longer Than 250 Characters

If the response containing the read data is longer than 250 characters, the response is divided into multiple frames as shown below. Only the final response frame ends in a terminator (\*CR). All other frames end in a delimiter (CR).

By default, each response frame is separated by 20 ms. The interval between frames can be changed using the PARAMETER SET (SP) command.

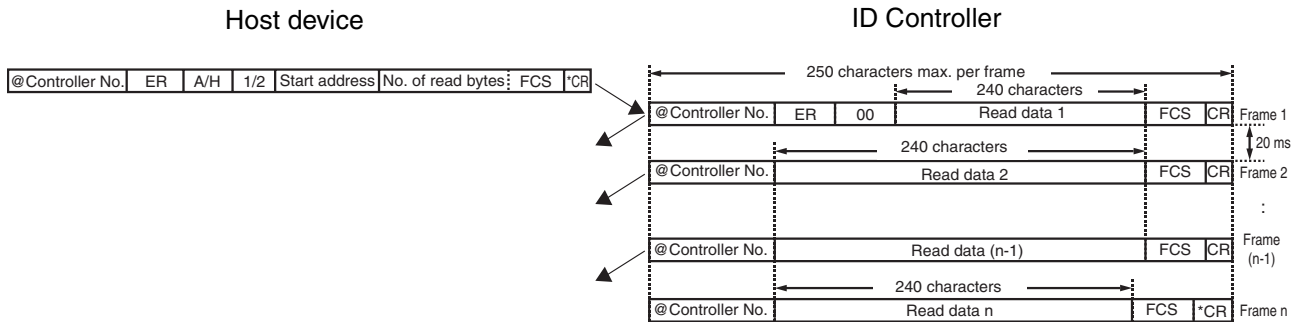
 p. 230



End code	<p>Indicates the execution result for the command. "00" indicates a normal end.</p> <p>Refer to List of End Codes for information on other end codes.  p. 235</p>
Read data	<p>The data read from the Tag. The number of characters will be the same as the specified number of bytes to read for ASCII data and twice that number for hexadecimal data.</p>

■ **AUTO READ (AR)**

The AUTO READ command Reads data from Tag memory when the Tag approaches. The ID Controller will return a response when communications with the Tag have been completed.

■ **1:1 Protocol**

**Command**

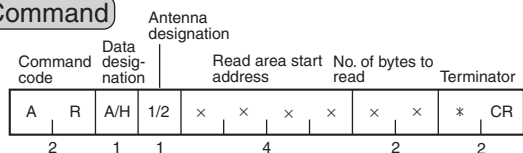

Data designation	Specifies the code format when sending the read data response. “A”: ASCII “H”: Hexadecimal
Antenna designation	Specifies the Antenna with which to communicate. “1”: Antenna 1 “2”: Antenna 2
Read area start address	Specifies the start address of the area in the Tag from which data is to be read from in 4-digit hexadecimal. Setting range: 0000H to FFFFH
No. of bytes to read	Specifies the number of bytes of data to read from the Tag in 2-digit hexadecimal. Up to 256 bytes can be read with one command. Setting range: 00H to FF (Specify 00H for 256 bytes.) • ASCII: 256 bytes (256 characters) • Hexadecimal: 256 bytes (512 characters)

**Response**

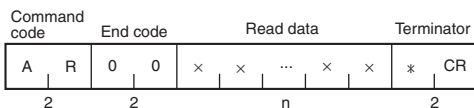

End code	Indicates the execution result for the command. “00” indicates a normal end.  Refer to List of End Codes for information on other end codes.  p. 235
Read data	The data read from the Tag. The number of characters will be the same as the specified number of bytes to read for ASCII data and twice that number for hexadecimal data.

▪ 1:N Protocol

Command

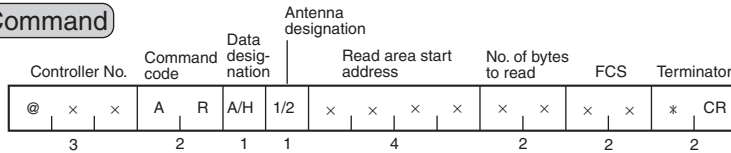

Data designation	Specifies the code format when sending the read data response. "A": ASCII "H": Hexadecimal
Antenna designation	Specifies the Antenna with which to communicate. "1": Antenna 1 "2": Antenna 2
Read area start address	Specifies the start address of the area in the Tag from which data is to be read from in 4-digit hexadecimal. Setting range: 0000H to FFFFH
No. of bytes to read	Specifies the number of bytes of data to read from the Tag in 2-digit hexadecimal. Up to 256 bytes can be read with one command. Setting range: 00H to FF (Specify 00H for 256 bytes.) • ASCII: 256 bytes (256 characters) • Hexadecimal: 256 bytes (512 characters)

Response

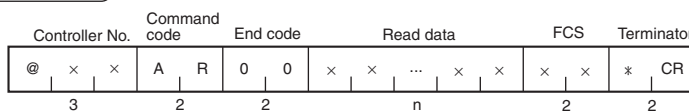

End code	Indicates the execution result for the command. "00" indicates a normal end.  Refer to List of End Codes for information on other end codes.  p. 235
Read data	The data read from the Tag. The number of characters will be the same as the specified number of bytes to read for ASCII data and twice that number for hexadecimal data.

## ■ AUTO WRITE (AW)

The AUTO WRITE command writes data to Tag memory when the Tag approaches. The ID Controller will return a response when communications with the Tag have been completed.

### ■ 1:1 Protocol

#### Command

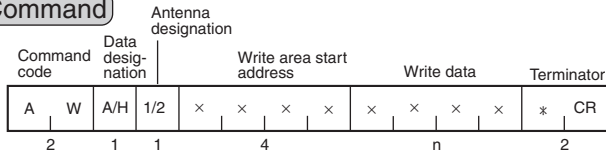

Data designation	Specifies the code format when sending the Tag write data. “A”: ASCII “H”: Hexadecimal
Antenna designation	Specifies the Antenna with which to communicate. “1”: Antenna 1 “2”: Antenna 2
Write area start address	Specifies the start address of the area in the Tag to which data is to be written in 4-digit hexadecimal. Setting range: 0000H to FFFFH
Write data	Specified the data to be written to the Tag. Up to 256 bytes can be written with one command. <ul style="list-style-type: none"> <li>• ASCII: 256 bytes (256 characters)</li> <li>• Hexadecimal: 256 bytes (512 characters)</li> </ul> <b>Note:</b> When hexadecimal is designated, set two characters for each byte.

#### Response

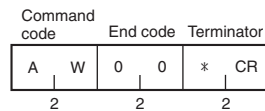

End code	Indicates the execution result for the command. “00” indicates a normal end.  Refer to List of End Codes for information on other end codes.   p. 235
----------	---

■ 1:N Protocol

Command

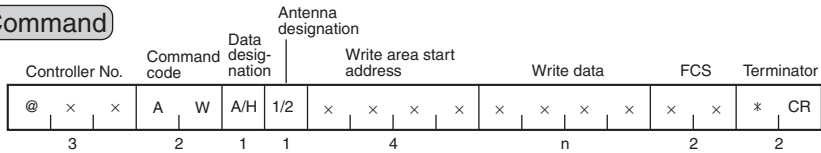

Data designation	Specifies the code format when sending the Tag write data. “A”: ASCII “H”: Hexadecimal
Antenna designation	Specifies the Antenna with which to communicate. “1”: Antenna 1 “2”: Antenna 2
Write area start address	Specifies the start address of the area in the Tag to which data is to be written in 4-digit hexadecimal. Setting range: 0000H to FFFFH
Write data	Specified the data to be written to the Tag. Up to 256 bytes can be written with one command. <ul style="list-style-type: none"> <li>• ASCII: 256 bytes (256 characters)</li> <li>• Hexadecimal: 256 bytes (512 characters)</li> </ul> <b>Note:</b> When hexadecimal is designated, set two characters for each byte.

Response

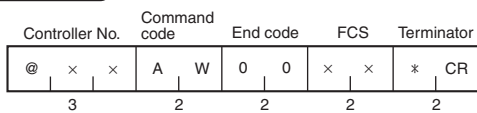

End code	Indicates the execution result for the command. “00” indicates a normal end.  Refer to List of End Codes for information on other end codes.   p. 235
----------	---

■ **DATA FILL (DF)**

The DATA FILL command writes the specified data to the specified number of bytes beginning from the specified start address. If there is no Tag in the communications area, the ID Controller will return an error response with an error code of 72 (Tag missing error).

■ **1:1 Protocol**

**Command**

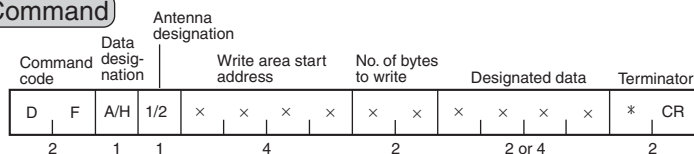

Data designation	Specifies the code format when sending the read data response. “A”: ASCII “H”: Hexadecimal
Antenna designation	Specifies the Antenna with which to communicate. “1”: Antenna 1 “2”: Antenna 2
Write area start address	Specifies the start address of the area in the Tag to which data is to be written in 4-digit hexadecimal. Setting range: 0000H to FFFFH
No. of bytes to write	When specifying in odd bytes, this writes the 1 digit prior to the designated data for ASCII code specification, or the 2 digits of the designated data for hexadecimal specification, to the last 1 byte of data in the Tag. Specifiable range: 01H to FFH, 00H (The maximum of 256 bytes will be written if 00H is specified.)
Designated data	Specified the data to be written to the Tag. • ASCII: 2 digits specified. • Hexadecimal: 4 digits specified.

**Response**

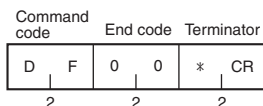

End code	Indicates the execution result for the command. “00” indicates a normal end.  Refer to List of End Codes for information on other end codes.   p. 235
----------	---



**Example 1**

The following example fills 6 bytes (0006H) of memory starting from address 0030H with 0101H for a Tag in which the same data as the address is written.

**Command**

Command code		Data designation	R/W Head channel designation				Write area start address	No. of bytes to write	Designated data	Terminator	
D	F	H	1/2						*	CR	
2	1	1		0	0	3	0	0	1	0	1
								2			2

**Response**

Command code		End code	Terminator
D	F	0	0
2	2	*	CR

	Before Writing			After Writing	
002FH	2	F	002FH	2	F
0030H	3	0	0030H	0	1
0031H	3	1	0031H	0	1
0032H	3	2	0032H	0	1
0033H	3	3	0033H	0	1
0034H	3	4	0034H	0	1
0035H	3	5	0035H	0	1
0036H	3	6	0036H	3	6

**Example 2**

The following example fills 5 bytes (0005H) of memory starting from address 0030H with 1234H for a Tag in which the same data as the address is written.

**Command**

Command code		Data designation	R/W Head channel designation				Write area start address	No. of bytes to write	Designated data	Terminator			
D	F	H	1/2						*	CR			
2	1	1		0	0	3	0	0	5	1	2	3	4
								2			2		

**Response**

Command code		End code	Terminator
D	F	0	0
2	2	*	CR

	Before Writing			After Writing	
002FH	2	F	002FH	2	F
0030H	3	0	0030H	1	2
0031H	3	1	0031H	3	4
0032H	3	2	0032H	1	2
0033H	3	3	0033H	3	4
0034H	3	4	0034H	1	2
0035H	3	5	0035H	3	5
0036H	3	6	0036H	3	6

■ 1:N Protocol

**Command**

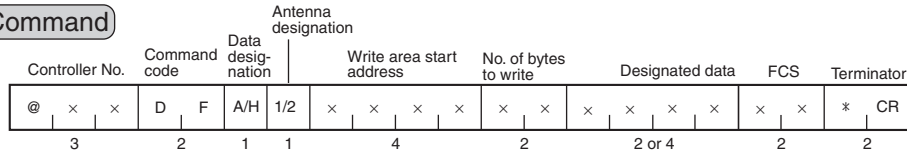

Data designation	Specifies the code format when sending the read data response. “A”: ASCII “H”: Hexadecimal
Antenna designation	Specifies the Antenna with which to communicate. “1”: Antenna 1 “2”: Antenna 2
Write area start address	Specifies the start address of the area in the Tag to which data is to be written in 4-digit hexadecimal. Setting range: 0000H to FFFFH
No. of bytes to write	When specifying in odd bytes, this writes the 1 digit prior to the designated data for ASCII code specification, or the 2 digits of the designated data for hexadecimal specification, to the last 1 byte of data in the Tag. Specifiable range: 01H to FFH, 00H (The maximum of 256 bytes will be written if 00H is specified.)
Designated data	Specified the data to be written to the Tag. • ASCII: 2 digits specified. • Hexadecimal: 4 digits specified.

**Response**

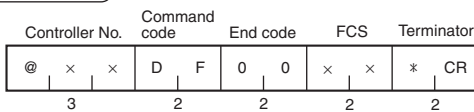

End code	Indicates the execution result for the command. “00” indicates a normal end.  Refer to List of End Codes for information on other end codes.  p. 235
----------	---

## ■ AUTO DATA FILL (AF)

The AUTO DATA FILL command writes the specified data to the specified number of bytes beginning from the specified start address when the Tag approaches. A response will be returned when communications with the Tag have been completed.

### ■ 1:1 Protocol

#### Command

Command code		Data designation	Antenna designation	Write area start address				No. of bytes to write		Designated data				Terminator	
A	F	A/H	1/2	x	x	x	x	x	x	x	x	x	x	*	CR
2		1	1	4				2		2 or 4				2	

Data designation	Specifies the code format when sending the read data response. “A”: ASCII “H”: Hexadecimal
Antenna designation	Specifies the Antenna with which to communicate. “1”: Antenna 1 “2”: Antenna 2
Write area start address	Specifies the start address of the area in the Tag to which data is to be written in 4-digit hexadecimal. Setting range: 0000H to FFFFH
No. of bytes to write	When specifying in odd bytes, this writes the 1 digit prior to the designated data for ASCII code specification, or the 2 digits of the designated data for hexadecimal specification, to the last 1 byte of data in the Tag. Specifiable range: 01H to FFH, 00H (The maximum of 256 bytes will be written if 00H is specified.)
Designated data	Specified the data to be written to the Tag. • ASCII: 2 digits specified. • Hexadecimal: 4 digits specified.

#### Response

Command code		End code	Terminator	
A	F	0	0	* CR
2		2		2

End code	Indicates the execution result for the command. “00” indicates a normal end.  Refer to List of End Codes for information on other end codes.  p. 235
----------	---

■ 1:N Protocol

**Command**

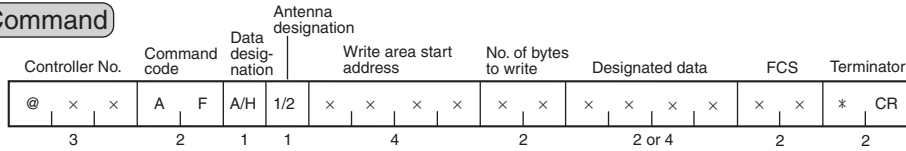

Data designation	Specifies the code format when sending the read data response. “A”: ASCII “H”: Hexadecimal
Antenna designation	Specifies the Antenna with which to communicate. “1”: Antenna 1 “2”: Antenna 2
Write area start address	Specifies the start address of the area in the Tag to which data is to be written in 4-digit hexadecimal. Setting range: 0000H to FFFFH
No. of bytes to write	When specifying in odd bytes, this writes the 1 digit prior to the designated data for ASCII code specification, or the 2 digits of the designated data for hexadecimal specification, to the last 1 byte of data in the Tag. Specifiable range: 01H to FFH, 00H (The maximum of 256 bytes will be written if 00H is specified.)
Designated data	Specified the data to be written to the Tag. • ASCII: 2 digits specified. • Hexadecimal: 4 digits specified.

**Response**

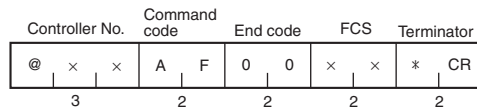

End code	Indicates the execution result for the command. “00” indicates a normal end.  Refer to List of End Codes for information on other end codes.   p. 235
----------	---

■ Copy (CP)

The COPY command reads data from the memory of the Tag in one Antenna's communications area and writes it to the memory of the Tag in the other Antenna's communications area. If there is no Tag to copy data from, the ID Controller will return an error response with an error code of 72 (Tag missing error). If there is no Tag to write to, the ID Controller will return an error response with an error code of 76 (copy error).

This command cannot be used with the V680-CA5D01-V2.

■ 1:1 Protocol

Command

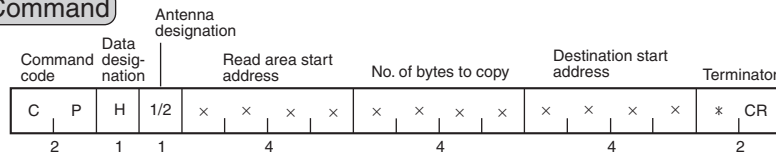

Data designation	Always "H".
Antenna designation	Specifies the Antenna with which to communicate. "1": Reads from Antenna 1 and writes to Antenna 2. "2": Reads from Antenna 2 and writes to Antenna 1.
Read area start address	Specifies the start address of the area in the Tag from which data is to be read from in 4-digit hexadecimal. Setting range: 0000H to FFFFH
No. of bytes to copy	Specifies the number of bytes of data to copy in 4-digit hexadecimal. Setting range: 0001H to 0800H
Destination start address	Specifies the start address of the area in the Tag to which data is to be written in 4-digit hexadecimal. Setting range: 0000H to FFFFH

Response

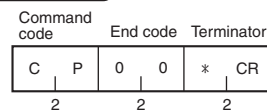

End code	Indicates the execution result for the command. "00" indicates a normal end.  Refer to List of End Codes for information on other end codes.  p. 235
----------	---

■ 1:N Protocol

**Command**

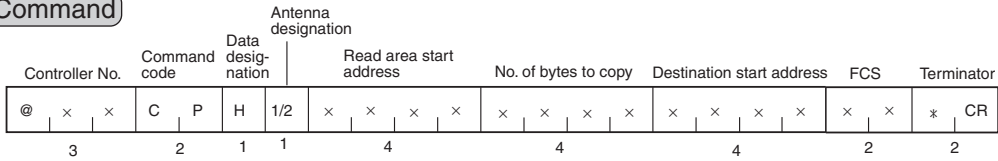

Data designation	Always "H".
Antenna designation	Specifies the Antenna with which to communicate. "1": Reads from Antenna 1 and writes to Antenna 2. "2": Reads from Antenna 2 and writes to Antenna 1.
Read area start address	Specifies the start address of the area in the Tag from which data is to be read from in 4-digit hexadecimal. Setting range: 0000H to FFFFH
No. of bytes to copy	Specifies the number of bytes of data to copy in 4-digit hexadecimal. Setting range: 0001H to 0800H
Destination start address	Specifies the start address of the area in the Tag to which data is to be written in 4-digit hexadecimal. Setting range: 0000H to FFFFH

**Response**

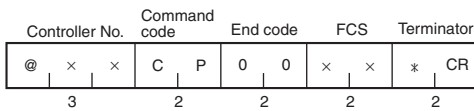

End code	Indicates the execution result for the command. "00" indicates a normal end.  Refer to List of End Codes for information on other end codes.  p. 235
----------	---

## ■ AUTO COPY (AP)

When the ID Controller receives the AUTO COPY command, it waits for Tags to approach and then reads data from the memory of the Tag using one Antenna and writes it to the memory of the Tag in the other Antenna's communications area. An error response (end code 76: copy error) will be returned if there is no Tag at the copy destination.

This command cannot be used with the V680-CA5D01-V2.

### ■ 1:1 Protocol

#### Command

Command designation		Data designation	Antenna designation				Read area start address				No. of bytes to copy				Destination start address				Terminator	
A	P	H	1/2	x	x	x	x	x	x	x	x	x	x	x	x	x	x	*	CR	
2		1	1	4				4				4				2				

Data designation	Always "H".
Antenna designation	Specifies the Antenna with which to communicate. "1": Reads from Antenna 1 and writes to Antenna 2. "2": Reads from Antenna 2 and writes to Antenna 1.
Read area start address	Specifies the start address of the area in the Tag from which data is to be read from in 4-digit hexadecimal. Setting range: 0000H to FFFFH
No. of bytes to copy	Specifies the number of bytes of data to copy in 4-digit hexadecimal. Setting range: 0001H to 0800H
Destination start address	Specifies the start address of the area in the Tag to which data is to be written in 4-digit hexadecimal. Setting range: 0000H to FFFFH

#### Response

Command code		End code		Terminator	
A	P	0	0	*	CR
2		2		2	

End code	Indicates the execution result for the command. "00" indicates a normal end.  Refer to List of End Codes for information on other end codes.  p. 235
----------	---

■ 1:N Protocol

**Command**

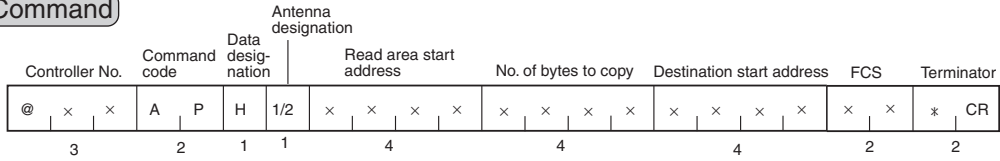

Data designation	Always "H".
Antenna designation	Specifies the Antenna with which to communicate. "1": Reads from Antenna 1 and writes to Antenna 2. "2": Reads from Antenna 2 and writes to Antenna 1.
Read area start address	Specifies the start address of the area in the Tag from which data is to be read from in 4-digit hexadecimal. Setting range: 0000H to FFFFH
No. of bytes to copy	Specifies the number of bytes of data to copy in 4-digit hexadecimal. Setting range: 0001H to 0800H
Destination start address	Specifies the start address of the area in the Tag to which data is to be written in 4-digit hexadecimal. Setting range: 0000H to FFFFH

**Response**

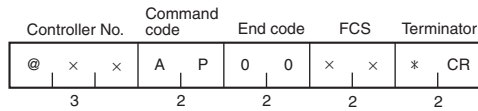

End code	Indicates the execution result for the command. "00" indicates a normal end.  Refer to List of End Codes for information on other end codes.  p. 235
----------	---



## ■ POLLING AUTO READ (PR)

When the ID Controller receives a POLLING AUTO READ command from the host device, it immediately sends a response acknowledging that the command was received. Data is then read when a Tag approaches. During this interval, subcommand can be used to check on the command processing results. Command can also be sent to the other Antenna during this interval.

### ■ 1:1 Protocol

#### Command

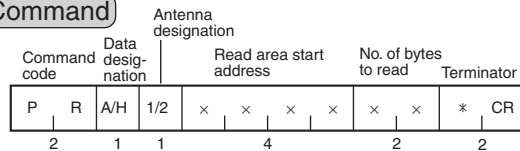

Data designation	Specifies the code format when sending the read data response. “A”: ASCII “H”: Hexadecimal
Antenna designation	Specifies the Antenna with which to communicate. “1”: Antenna 1 “2”: Antenna 2
Read area start address	Specifies the start address of the area in the Tag from which data is to be read from in 4-digit hexadecimal. Setting range: 0000H to FFFFH
No. of bytes to read	Specifies the number of bytes of data to read from the Tag in 2-digit hexadecimal. Up to 256 bytes can be read with one command. Setting range: 00H to FF (Specify 00H for 256 bytes.) • ASCII: 256 bytes (256 characters) • Hexadecimal: 256 bytes (512 characters)

#### Response

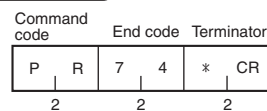

End code	Indicates the execution result for the command. “74”: Polling command received The only error codes that may be returned here are 74 and communications errors with the host device.  Refer to List of End Codes for information on other end codes.  p. 235
----------	--

**Subcommand**

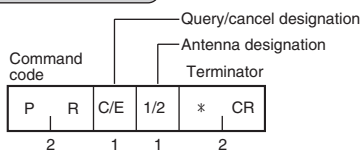

Query/cancel designation	Specifies querying or canceling polling auto processing. “C”: Processing results query “E”: Processing results cancel
Antenna designation	Specifies the Antenna for querying or canceling. “1”: Antenna 1 “2”: Antenna 2

**Subcommand Response**

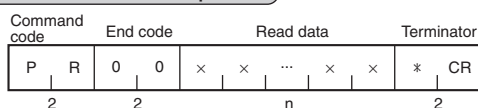

End code	Indicates the execution result for the command. “00”: Normal end “74”: No Tag has approached when polling auto processing results were requested. “75”: No Tag has approached when polling auto processing was cancelled. “76”: Communications processing was in progress or completed when polling auto processing was cancelled.  Refer to List of End Codes for information on other end codes. p. 235
Read data	The data that was read according to the command that was executed.

1:N Protocol

Command

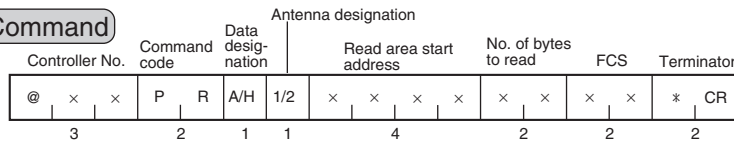

Data designation	Specifies the code format when sending the read data response. "A": ASCII "H": Hexadecimal
Antenna designation	Specifies the Antenna with which to communicate. "1": Antenna 1 "2": Antenna 2
Read area start address	Specifies the start address of the area in the Tag from which data is to be read from in 4-digit hexadecimal. Setting range: 0000H to FFFFH
No. of bytes to read	Specifies the number of bytes of data to read from the Tag in 2-digit hexadecimal. Up to 256 bytes can be read with one command. Setting range: 00H to FFH (Specify 00H for 256 bytes.) • ASCII: 256 bytes (256 characters) • Hexadecimal: 256 bytes (512 characters)

Response

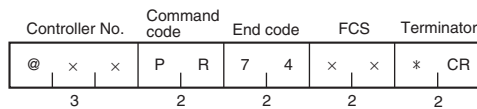

End code	Indicates the execution result for the command. "74": Polling command received  Refer to List of End Codes for information on other end codes.  p. 235
----------	---

**Subcommand**

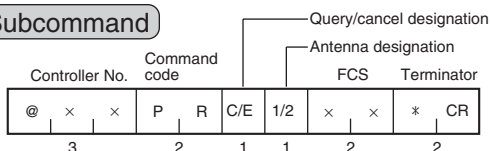

Query/cancel designation	Specifies querying or canceling polling auto processing. “C”: Processing results query “E”: Processing results cancel
Antenna designation	Specifies the Antenna for querying or canceling. “1”: Antenna 1 “2”: Antenna 2

**Subcommand Response**

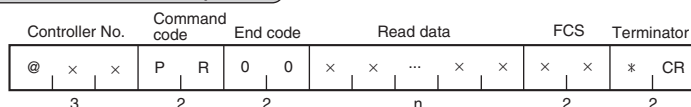

End code	Indicates the execution result for the command. “00”: Normal end “74”: No Tag has approached when polling auto processing results were requested. “75”: No Tag has approached when polling auto processing was cancelled. “76”: Communications processing was in progress or completed when polling auto processing was cancelled.  Refer to List of End Codes for information on other end codes.  p. 235
Read data	The data that was read according to the command that was executed.

## ■ POLLING AUTO WRITE (PW)

When the ID Controller receives a POLLING AUTO WRITE command from the host device, it immediately sends a response acknowledging that the command was received. Data is then written when a Tag approaches. During this interval, subcommand can be used to check on the command processing results. Command can also be sent to the other Antenna during this interval.

### ■ 1:1 Protocol

#### Command

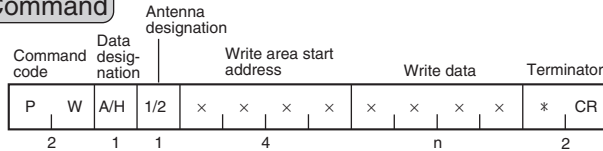

Data designation	Specifies the code format when sending the Tag write data. “A”: ASCII “H”: Hexadecimal
Antenna designation	Specifies the Antenna with which to communicate. “1”: Antenna 1 “2”: Antenna 2
Write area start address	Specifies the start address of the area in the Tag to which data is to be written in 4-digit hexadecimal. Setting range: 0000H to FFFFH
Write data	Specified the data to be written to the Tag. Up to 256 bytes can be written with one command. <ul style="list-style-type: none"> <li>• ASCII: 256 bytes (256 characters)</li> <li>• Hexadecimal: 256 bytes (512 characters)</li> </ul> <b>Note:</b> When hexadecimal is designated, set two characters for each byte.

#### Response

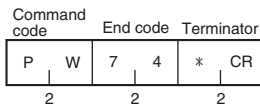

End code	Indicates the execution result for the command. “74”: Polling command received The only error codes that may be returned here are 74 and communications errors with the host device.  Refer to List of End Codes for information on other end codes.  p. 235
----------	--

**Subcommand**

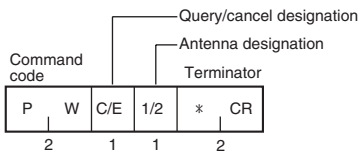

Query/cancel designation	Specifies querying or canceling polling auto processing. “C”: Processing results query “E”: Processing results cancel
Antenna designation	Specifies the Antenna for querying or canceling. “1”: Antenna 1 “2”: Antenna 2

**Subcommand Response**

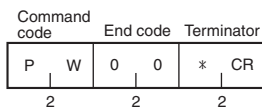

End code	Indicates the execution result for the command. “00”: Normal end “74”: No Tag has approached when polling auto processing results were requested. “75”: No Tag has approached when polling auto processing was cancelled. “76”: Communications processing was in progress or completed when polling auto processing was cancelled.  Refer to List of End Codes for information on other end codes.  p. 235
----------	--

1:N Protocol

Command

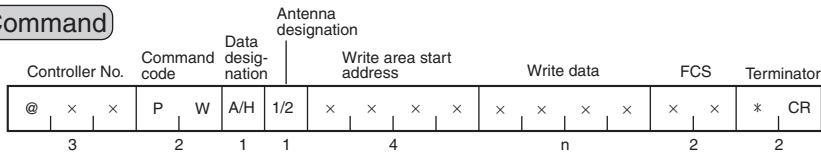

Data designation	Specifies the code format when sending the Tag write data. "A": ASCII "H": Hexadecimal
Antenna designation	Specifies the Antenna with which to communicate. "1": Antenna 1 "2": Antenna 2
Write area start address	Specifies the start address of the area in the Tag to which data is to be written in 4-digit hexadecimal. Setting range: 0000H to FFFFH
Write data	Specified the data to be written to the Tag. Up to 256 bytes can be written with one command. <ul style="list-style-type: none"> <li>• ASCII: 256 bytes (256 characters)</li> <li>• Hexadecimal: 256 bytes (512 characters)</li> </ul> <b>Note:</b> When hexadecimal is designated, set two characters for each byte.

Response

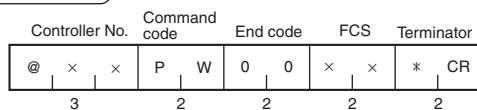

End code	Indicates the execution result for the command. "74": Polling command received The only error codes that may be returned here are 74 and communications errors with the host device.  Refer to List of End Codes for information on other end codes.  p. 235
----------	--

**Subcommand**

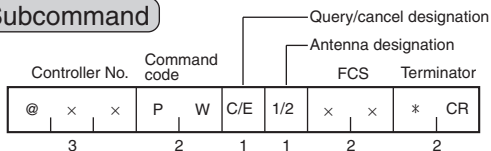

Query/cancel designation	Specifies querying or canceling polling auto processing. “C”: Processing results query “E”: Processing results cancel
Antenna designation	Specifies the Antenna for querying or canceling. “1”: Antenna 1 “2”: Antenna 2

**Subcommand Response**

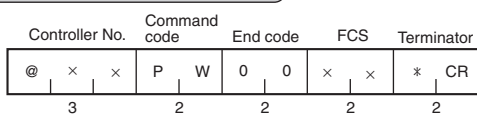

End code	Indicates the execution result for the command. “00”: Normal end “74”: No Tag has approached when polling auto processing results were requested. “75”: No Tag has approached when polling auto processing was cancelled. “76”: Communications processing was in progress or completed when polling auto processing was cancelled.  Refer to List of End Codes for information on other end codes.  p. 235
----------	--



■ DATA CHECK (MD C/K)

The DATA CHECK command is used to write or verify the CRC code in the specified check block. The CRC code is generated using the following polynomial  $X^{16} + X^{12} + X^5 + 1$ .

■ 1:1 Protocol

Command

Command code		Process designation	Antenna designation	Check block start address				No. of check block bytes		Terminator
M	D	C/K	1/2	x	x	x	x	x	x	* CR
2		1	1	4				2		2

Process designation	Specifies the check process. “C”: Check code verification “K”: Check code calculation
Antenna designation	Specifies the Antenna with which to communicate. “1”: Antenna 1 “2”: Antenna 2
Check block start address	Specifies the start address of the check block in 4-digit hexadecimal. Setting range: 0000H to FFFDH
No. of check block bytes	Specifies the number of bytes in the check block in 2-digit hexadecimal. Setting range: 00H, 03H to FFH (Specify 00H for 256 bytes.)  Specify the number of bytes in the check code calculation area plus two for the number of check block bytes. Refer to <i>Tag Memory Error Correction</i> for details.  p. 94

Response

Command code		End code	Terminator
M	D	x	* CR
2		2	2

End code	Indicates the execution result for the command. 00: Normal end 75: Data normal (only when verification is performed) 76: Data error warning (only when verification is performed)  Refer to List of End Codes for information on other end codes.  p. 235
----------	--



Refer to *Tag Memory Error Correction* for details on memory checks.

 p. 94

■ 1:N Protocol

**Command**

Controller No.			Command code		Process designation		Antenna designation				Check block start address		No. of check block bytes		FCS		Terminator	
@	x	x	M	D	C/K	1/2	x	x	x	x	x	x	x	x	x	*	CR	
3			2		1		1				4				2		2	

Process designation	Specifies the check process. “C”: Check code verification “K”: Check code calculation
Antenna designation	Specifies the Antenna with which to communicate. “1”: Antenna 1 “2”: Antenna 2
Check block start address	Specifies the start address of the check block in 4-digit hexadecimal. Setting range: 0000H to FFFDH
No. of check block bytes	Specifies the number of bytes in the check block in 2-digit hexadecimal. Setting range: 00H, 03H to FFH (Specify 00H for 256 bytes.)  Specify the number of bytes in the check code calculation area plus two for the number of check block bytes. Refer to <i>Tag Memory Error Correction</i> Function for details.  p. 94

**Response**

Controller No.			Command code		End code		FCS		Terminator	
@	x	x	M	D	x	x	x	x	*	CR
3			2		2		2		2	

End code	Indicates the execution result for the command. 00: Normal end 75: Data normal (only when verification is performed) 76: Data error warning (only when verification is performed)  Refer to List of End Codes for information on other end codes.  p. 235
----------	--

 Refer to *Tag Memory Error Correction* for details on memory checks.

CHECK!  p. 94

## OVERWRITE COUNT CONTROL (MD S/L)

The OVERWRITE COUNT CONTROL command is used to manage overwrite counts for EEPROM Tags.

The specified overwrite count control area data is updated to enable determining when the EEPROM's write life has expired.

### 1:1 Protocol

#### Command

Command code		Mode designation	Antenna designation	Area start address				Decrement count		Terminator	
M	D	S/L	1/2	x	x	x	x	x	x	*	CR
2		1	1	4				2		2	

Mode designation	Specifies the check process. “S”: Subtraction (Overwrite control count can be set by user.) (16,700,000 writes max.) (See note.) “L”: Addition (Overwrite control count fixed at 100,000 writes.)
Antenna designation	Specifies the Antenna with which to communicate. “1”: Antenna 1 “2”: Antenna 2
Area start address	Specifies the start address of the overwrite count control area in 4-digit hexadecimal. Setting range: □□□0H to □□□5H or □□□8H to □□□DH
Decrement count	Specifies the number of refresh operations in 2-digit hexadecimal. Setting range: 00H to FFH (00H: Performs overwrite count check only)  Refer to <i>Tag Service Life Check</i> for details.  p. 91

**Note:** The write life for EEPROM Tags is 300,000 writes at 40°C.



CHECK!

When set to □□□6H to □□□7H or □□□EH to □□□FH, an address error (code: 7A (hexadecimal)) will be returned as the end code.

#### Response

Command code		End code	Terminator	
M	D	7	5	* CR
2		2	2	

End code	Indicates the execution result for the command. 75: Normal end 76: Data error warning  Refer to <i>List of End Codes</i> for information on other end codes.  p. 235
----------	--

■ 1:N Protocol

**Command**

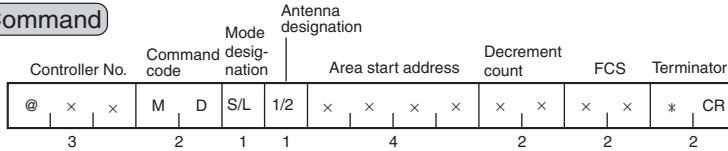

Mode designation	Specifies the check process. “S”: Subtraction (Overwrite control count can be set by user.) (16,700,000 writes max.) (See note.) “L”: Addition (Overwrite control count fixed at 100,000 writes.)
Antenna designation	Specifies the Antenna with which to communicate. “1”: Antenna 1 “2”: Antenna 2
Area start address	Specifies the start address of the overwrite count control area in 4-digit hexadecimal. Setting range: □□□0H to □□□5H or □□□8H to □□□DH
Decrement count	Specifies the number of refresh operations in 2-digit hexadecimal. Setting range: 00H to FFH (00H: Performs overwrite count check only)  Refer to <i>Tag Service Life Check</i> for details.  p. 91

**Note:** The write life for EEPROM Tags is 300,000 writes at 40°C.



When set to □□□6H to □□□7H or □□□EH to □□□FH, an address error (code: 7A (hexadecimal)) will be returned as the end code.

**Response**

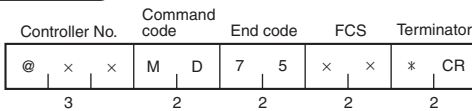

End code	Indicates the execution result for the command. 75: Normal end 76: Data error warning  Refer to <i>List of End Codes</i> for information on other end codes.  p. 235
----------	--

## ■ WRITE REPEAT (RP)

The WRITE REPEAT command is used to execute the most recently executed write command again.

### ■ 1:1 Protocol

#### Command

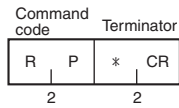

#### Response

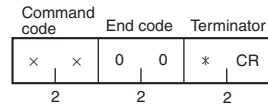

Command code	The command code is the same as the last write command that was executed.
End code	Indicates the execution result for the command. "00" indicates a normal end.  Refer to List of End Codes for information on other end codes.  p. 235



Write command information is cleared at the following time.

- When the ID Controller's power supply is reset.

If a WRITE REPEAT command is executed after write command information has been cleared, a command input error will occur.

▪ **1:N Protocol**

**Command**

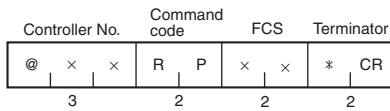

**Response**

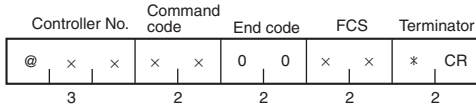

Command code	The command code is the same as the last write command that was executed.
End code	Indicates the execution result for the command. "00" indicates a normal end.  Refer to List of End Codes for information on other end codes.  p. 235



Write command information is cleared at the following time.

- When the ID Controller's power supply is reset.

If a WRITE REPEAT command is executed after write command information has been cleared, a command input error will occur.

## Communications Subcommands

Communications subcommands are used in combination with commands for Tag communications. They cannot be used by themselves to communicate with a Tag.

### ■ COMMAND PROCESSING TERMINATE (AA)

The COMMAND PROCESSING TERMINATE command cancels any command except for polling commands and returns the ID Control to command standby status. This command can also be used to cancel communications for expansion commands with divided frames before completion of the expansion command.

#### ■ 1:1 Protocol

##### Command

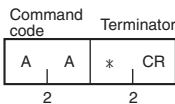

##### Response

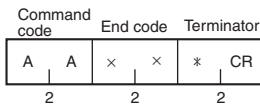

End code	<p>Indicates the execution result for the command.</p> <p>14: No automatic or normal commands being processed. 75: Processing terminated before a Tag was detected. 76: Processing terminated while reading from or writing to a Tag.</p> <p>Refer to List of End Codes for information on other end codes.</p> <p> p. 235</p>
----------	---

#### ■ 1:N Protocol

##### Command

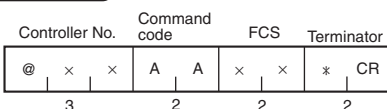

##### Response

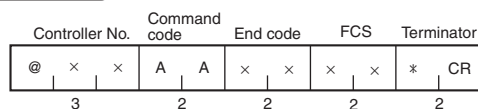

End code	<p>Indicates the execution result for the command.</p> <p>14: No automatic or normal commands being processed. 75: Processing terminated before a Tag was detected. 76: Processing terminated while reading from or writing to a Tag.</p> <p>Refer to List of End Codes for information on other end codes.</p> <p> p. 235</p>
----------	---

■ **ABORT (XZ)**

The ABORT command can be used to reset the ID Controller to command standby status during communications with the host device or a Tag if any sort of trouble occurs, e.g., if the ID Controller does not return a response. The ID Controller does not return a response to the ABORT command.

■ **1:1 Protocol**

**Command**

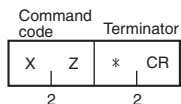

CHECK!

About 100 ms is required after the ID Controller receives the ABORT command before it can receive the next command.

■ **1:N Protocol**

**Command**

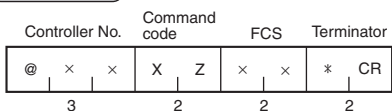

CHECK!

About 100 ms is required after the ID Controller receives the ABORT command before it can receive the next command.



## Host Commands

### ■ TEST (TS)

The TEST command is used to test communications between the host device and ID Controller. The TEST command is used to send a text message from the host device to the ID Controller. The ID Controller returns the same text message unaltered.

#### ■ 1:1 Protocol

##### Command

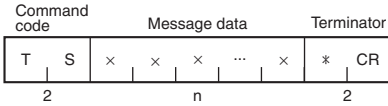

Message data	Any text string to use to text communications. Number of characters: 262 max.
--------------	--

##### Response

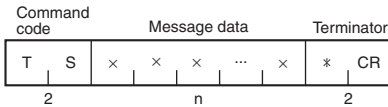

#### ■ 1:N Protocol

##### Command

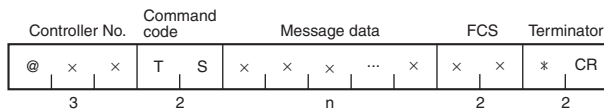

Message data	Any text string to use to text communications. Number of characters: 262 max.
--------------	--

##### Response

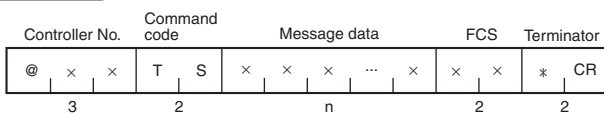

■ **CONTROLLER CONTROL (CC)**

The CONTROLLER CONTROL command is used to manipulate or read I/O.

■ **1:1 Protocol**

**Command**

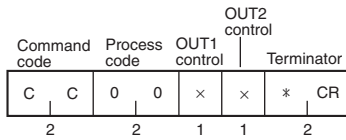

Process code	Always "00".
OUT1/OUT2 controls	0: No operation 1: Turn ON 2: Turn OFF

**Response**

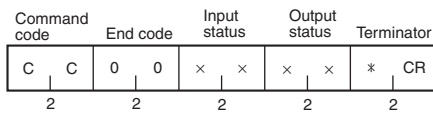

End code	Indicates the execution result for the command. "00" indicates a normal end.  Refer to List of End Codes for information on other end codes.  p. 235
Input status	The current input status (1st character: TRG1, 2nd character: TRG2) 0: OFF 1: ON
Output status	The output status after processing (1st character: OUT1, 2nd character: OUT2) 0: OFF 1: ON

▪ 1:N Protocol

Command

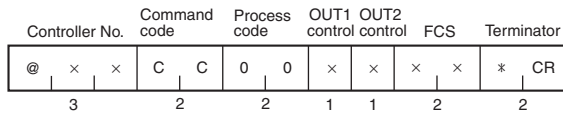

Process code	Always "00".
OUT1/OUT2 controls	0: No operation 1: Turn ON 2: Turn OFF

Response

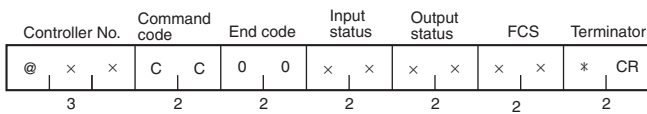

End code	Indicates the execution result for the command. "00" indicates a normal end.  Refer to List of End Codes for information on other end codes.  p. 235
Input status	The current input status (1st character: TRG1, 2nd character: TRG2) 0: OFF 1: ON
Output status	The output status after processing (1st character: OUT1, 2nd character: OUT2) 0: OFF 1: ON

■ **READ ERROR INFORMATION (CF)**

The READ ERROR INFORMATION command is used to read the most recent error log information stored in the Controller.

■ **1:1 Protocol**

**Command**

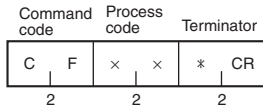

Process code	Specifies the process to execute. "00": Read error information "01": Clear error information
--------------	--

**Response**

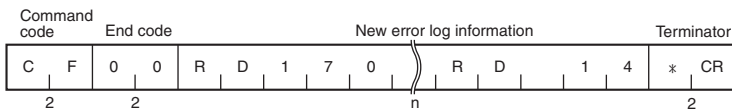

End code	Indicates the execution result for the command. "00" indicates a normal end.  Refer to List of End Codes for information on other end codes. p. 235						
New error log information	Up to 30 records of error log information will be returned. Error log information is returned in chronological order with the newest records first. Each record is five characters long.  <table style="margin-left: 40px; border-collapse: collapse;"> <tr> <td style="border-right: 1px solid black; padding-right: 5px;">RD 1 70</td> <td style="padding-left: 5px;">Generated error code</td> </tr> <tr> <td style="border-right: 1px solid black; padding-right: 5px;"> </td> <td style="padding-left: 5px;">Head No. with error (for communications with Data Carriers only) A space will be output for when the error is not a communications error.</td> </tr> <tr> <td style="border-right: 1px solid black; padding-right: 5px;"> </td> <td style="padding-left: 5px;">Error command</td> </tr> </table>	RD 1 70	Generated error code		Head No. with error (for communications with Data Carriers only) A space will be output for when the error is not a communications error.		Error command
RD 1 70	Generated error code						
	Head No. with error (for communications with Data Carriers only) A space will be output for when the error is not a communications error.						
	Error command						

▪ 1:N Protocol

Command

Controller No.	Command code	Process code	FCS	Terminator
@ x x	C F	x x	x x	* CR
3	2	2	2	2

Process code	Specifies the process to execute. "00": Read error information "01": Clear error information
--------------	--

Response

Controller No.	Command code	End code	New error log information	FCS	Terminator
@ x x	C F	0 0 R D 1 7 0	n R D 1 4	x x	* CR
3	2	2	n	2	2

End code	Indicates the execution result for the command. "00" indicates a normal end.  Refer to List of End Codes for information on other end codes.  p. 235								
New error log information	Up to 30 records of error log information will be returned. Error log information is returned in chronological order with the newest records first. Each record is five characters long.  <div style="margin-left: 40px;"> <table border="0"> <tr> <td>RD 1 70</td> <td rowspan="3">Generated error code</td> </tr> <tr> <td>_____</td> </tr> <tr> <td>_____</td> </tr> <tr> <td>_____</td> <td>Head No. with error (for communications with Data Carriers only) A space will be output for when the error is not a communications error.</td> </tr> <tr> <td>_____</td> <td>Error command</td> </tr> </table> </div>	RD 1 70	Generated error code	_____	_____	_____	Head No. with error (for communications with Data Carriers only) A space will be output for when the error is not a communications error.	_____	Error command
RD 1 70	Generated error code								
_____									
_____									
_____	Head No. with error (for communications with Data Carriers only) A space will be output for when the error is not a communications error.								
_____	Error command								

■ **COMMUNICATIONS SET (TR)**

The COMMUNICATIONS SET command is used to set serial communications parameters. To use the ID Controller with the new parameters, either restart the ID Controller or execute the ABORT command (XZ).



This command is valid only when internal settings are enabled (i.e., when pin 1 on SW3 is ON).

■ **1:1 Protocol**

**Command**

Command code		Baud rate designation	Data length designation			Parity	Stop bit length	Terminator
T	R	×	×	×	×	×	* CR	
		2	1	1	1	1	2	

Baud rate designation	Specify the baud rate. “3”: 9,600 bps “4”: 19,200 bps “5”: 38,400 bps “6”: 115,200 bps Default setting: 9,600 bps
Data length designation	Specify the data length. “7”: 7 bits “8”: 8 bits Default setting: 7 bit
Parity	Specify the type of parity. “0”: No parity “1”: Odd parity “2”: Even parity Default setting: Even parity
Stop bit length	Specify the number of stop bits. “1”: 1 bit “2”: 2 bits Default setting: 2 bits

**Response**

Command code		End code	Terminator
T	R	0 0	* CR
		2	2

End code	Indicates the execution result for the command. “00” indicates a normal end.  Refer to List of End Codes for information on other end codes. p. 235
----------	---

▪ 1:N Protocol

Command

Controller No.			Command code		Baud rate designation	Data length designation	Parity	Stop bit length	FCS	Terminator
@	x	x	T	R	x	x	x	x	x	* CR
3			2		1	1	1	1	2	2

Baud rate designation	Specify the baud rate. "3": 9,600 bps "4": 19,200 bps "5": 38,400 bps "6": 115,200 bps Default setting: 9,600 bps
Data length designation	Specify the data length. "7": 7 bits "8": 8 bits Default setting: 7 bits
Parity	Specify the type of parity. "0": No parity "1": Odd parity "2": Even parity Default setting: Even parity
Stop bit length	Specify the number of stop bits. "1": 1 bit "2": 2 bits Default setting: 2 bits

Response

Controller No.			Command code		End code	FCS	Terminator
@	x	x	T	R	0 0	x	x * CR
3			2		2	2	2

End code	Indicates the execution result for the command. "00" indicates a normal end.  Refer to List of End Codes for information on other end codes.  p. 235
----------	---

■ **PARAMETER SET (SP)**

The PARAMETER SET command is used to set conditions for communicating with Tags. The various parameters are set in the ID Controller.



The ID Controller does not need to be reset when internal settings are changed. The new settings are effective immediately.

CHECK!



A memory error will occur if the power supply is interrupted while parameters are being changed.

CHECK!

■ **1:1 Protocol**

**Command**

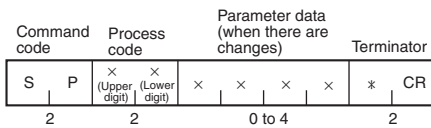

Process code (Upper digit)	Specifies the process to perform for the parameter. “0”: Change internal setting. “1”: Read internal setting. “9”: Return initial setting to default value.	
Process code (Lower digit)	Specifies the parameter. “1”: Controller No. (See note 1.) “2”: Write verification enable (See note 1.) “3”: Reception sensitivity “9”: Tag communications procedure (See note 1.) “B”: Lower trigger enable/disable (See note 1.) “C”: Error output time “D”: Number of test bytes setting “E”: Noise monitor function setting “G”: Noise detection count setting “H”: Write protection setting (See note 1.) “J”: Write protection method setting (See note 2.)	
Parameter data (when there are changes)	Data No. (See note 3.)	Settable values
	“1”	Specify 2 decimal digits. “00” to “31” (unit number) Default value: “00”
	“2”	“0”: Without verification “1”: With verification (default value)
	“3”	“0”: Low “1”: Standard (default value)
	“9”	“0”: 1:1 protocol (default value) “1”: 1:N protocol
	“B”	“0”: Disabled (default value) “1”: Enabled



Parameter data (when there are changes)	"C"	Specify 4 decimal digits. "0000" to "9999" (ms) "0000": Infinite, Default value: "0500" (ms)
	"D"	Specify 4 hexadecimal digits. "0001" to "0800" (bytes) Default value: "0001" (bytes)
	"E"	"0": Noise monitor function OFF (default value) "1": Noise monitor function ON
	"G"	Specify 4 decimal digits. "0001" to "0100" (times) Default value: "0010" (times)
	"H"	"0": Write protection OFF (default value) "1": Write protection ON
	"J"	"0": V680 write protection (default value) "1": V600 write protection

**Note 1:** Parameters 1, 2, 9, B, and H are valid only when internal settings are enabled (i.e., when pin 1 on SW3 is ON).

**Note 2:** Parameter J is valid only for version 2.1 or newer.

**Note 3:** The data number of the parameter data is the number specified for the lower digit of the process code.

The settable values for the data number are the same as for the parameter specified by the lower digit of the process code.

Response

Command code		End code		Parameter data				Terminator	
S	P	0	0	x	x	x	x	*	CR
2		2		1 to 4				2	

End code	Indicates the execution result for the command. "00" indicates a normal end.  Refer to <i>List of End Codes</i> for information on other end codes.  p. 235
Parameter data	Attached only when parameter data is being obtained.



Parameter J is valid only for version 2.1 or newer. For details on Checking the Version, refer to page 17.

1:N Protocol

Command

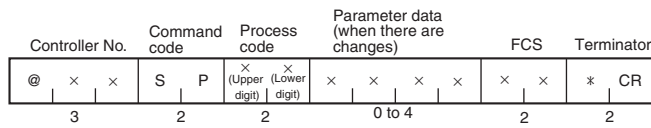

Process code (Upper digit)	Specifies the process to perform for the parameter. "0": Change internal setting. "1": Read internal setting. "9": Return initial setting to default value.	
Process code (Lower digit)	Specifies the parameter. "1": Controller No. (See note 1.) "2": Write verification enable (See note 1.) "3": Reception sensitivity "9": Tag communications procedure (See note 1.) "B": Lower trigger enable/disable (See note 1.) "C": Error output time "D": Number of test bytes setting "E": Noise monitor function setting "G": Noise detection count setting "H": Write protection setting (See note 1.) "J": Write protection method setting (See note 2.)	
Parameter data (when there are changes)	Data No. (See note 3.)	Settable values
	"1"	Specify 2 decimal digits. "00" to "31" (unit number) Default value: "00"
	"2"	"0": Without verification "1": With verification (default value)
	"3"	"0": Low "1": Standard (default value)
	"9"	"0": 1:1 protocol (default value) "1": 1:N protocol
	"B"	"0": Disabled (default value) "1": Enabled
	"C"	Specify 4 decimal digits. "0000" to "9999" (ms) "0000": Infinite, Default value: "0500" (ms)
	"D"	Specify 4 hexadecimal digits. "0001" to "0800" (bytes) Default value: "0001" (bytes)
	"E"	"0": Noise monitor function OFF (default value) "1": Noise monitor function ON
	"G"	Specify 4 decimal digits. "0001" to "0100" (times) Default value: "0010" (times)
"H"	"0": Write protection OFF (default value) "1": Write protection ON	
"J"	"0": V680 write protection (default value) "1": V600 write protection	

**Note 1:** Parameters 1, 2, 9, B, and H are valid only when internal settings are enabled (i.e., when pin 1 on SW3 is ON).

**Note 2:** Parameter J is valid only for version 2.1 or newer.

**Note 3:** The data number of the parameter data is the number specified for the lower digit of the process code. The settable values for the data number are the same as for the parameter specified by the lower digit of the process code.

Response

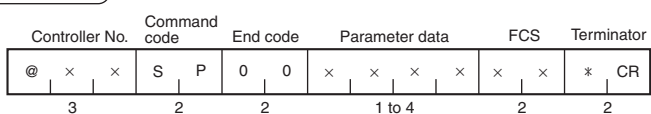

End code	<p>Indicates the execution result for the command.          “00” indicates a normal end.          Refer to List of End Codes for information on other end codes.   p. 235</p>
Parameter data	Attached only when parameter data is being obtained.



Parameter J is valid only for version 2.1 or newer. For details on Checking the Version, refer to page 17.

## Other Command Codes

### ■ UNDEFINED COMMAND RESPONSE (IC)

If the ID Controller receives a command code that is not in the list of commands, it will return a response for the undefined command to the host device.

#### ■ 1:1 Protocol

Response

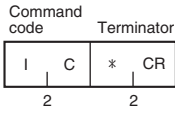

#### ■ 1:N Protocol

Response

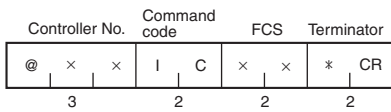

### ■ Error Response

If an error occurs during communications with the host device or the Tag, error information is provided in the end code.

#### ■ 1:1 Protocol

Response

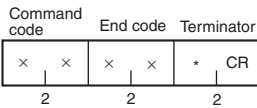

#### ■ 1:N Protocol

Response

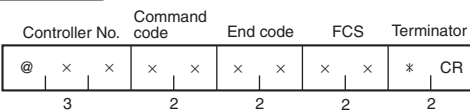

## List of End Codes

End codes are expressed in 2-digit hexadecimal.

Classification	End code	Name
Normal end	00	Normal end
	74	Polling command received or polling command query (no results information).
	75	Auto command cancelled. (Processing cancelled before a Tag was detected.)
		Polling command cancelled. (Processing cancelled before a Tag was detected.)
		Normal end for DATA CHECK command or OVERWRITE COUNT CONTROL command (no error)
	76	Auto command cancelled. (Processing cancelled after a Tag was detected.)
Polling command cancelled. (Processing cancelled after a Tag was detected.)		
Host communications error	10	Parity error
	11	Framing error
	12	Overrun error
	13	FCS error
	14	Format error
		Execution condition error
18	Frame length error	
Tag communications error	70	Tag communications error
	71	Mismatch error
	72	Tag missing error
	76	Copy error
	7A	Address error
	7C	Antenna not connected error
	7D	Write protected error
Tag memory warning	76	Error end (verification error or overwrite count exceeded) for DATA CHECK command or OVERWRITE COUNT CONTROL command
System error	92	Antenna internal power supply voltage error
	93	Internal memory error



Refer to *Error Lists* for details on error codes

CHECK!



p. 240

MEMO

# SECTION 6

## Troubleshooting

❑ Self-diagnostic Function	238
❑ Error Lists	240
❑ Errors and Countermeasures	244
❑ Maintenance and Inspection	245
❑ Troubleshooting	246

# Self-diagnostic Function

## Details of Errors

### Fatal Errors

If a CPU error or internal memory error occurs, the RUN/RST indicator will go out and RUN outputs will turn OFF. For internal memory errors, the COMM indicator will light red.

For Antenna supply voltage errors, the RUN/RST indicator will light green. RUN outputs will not turn OFF.

### Nonfatal Errors

If an error occurs in communications between the ID Controller and host device or between the Antenna and a Tag, an error code will be displayed on the monitor display (error code display mode). Details of up to 30 errors can be stored in memory and can be read with a command from the host device.

## Display and Output Status during Operation

### Two Output Mode

Status	Indicator				Monitor	Output terminal					
	RUN/RST	COMM	COMM1 COMM2	NORM1/ERR1 NORM2/ERR2		RUN	BUSY	ERROR	OUT1	OUT2	
Test	Processing communications	○	●	○	●	—	ON	OFF	OFF	—	—
	Communications processing interval	○	●	●	●	—	ON	OFF	OFF	—	—
	Communications normal	○	●	●	○	End code	ON	OFF	OFF	—	—
	Communications error	○	●	●	●	Error code	ON	OFF	OFF	—	—
RUN	Waiting for data send/receive	○	●	●	●	—	ON	OFF	—	—	—
	Sending/receiving data	○	○	○	●	—	ON	ON	OFF	OFF	OFF
	Communications normal	○	●	●	○	End code	ON	OFF	OFF	USR	USR
	Host communications error	○	●	●	●	Error code	ON	OFF	ON	OFF	OFF
	Communications error	○	●	●	●	Error code	ON	OFF	ON	OFF	OFF
Fatal error	CPU error	●	●	●	●	—	OFF	OFF	OFF	OFF	OFF
	Antenna power supply error	○	●	●	●	92	ON	OFF	OFF	OFF	OFF
	Internal memory error	●	●	●	●	93	OFF	OFF	OFF	OFF	OFF
Emergency stop	○	●	●	●	—	OFF	OFF	OFF	OFF	OFF	

●: Not lit   ○: Lit green   ○: Lit yellow   ●: Lit red

USR: Set with a CONTROLLER CONTROL command.



## ■ Four Output Mode

Status		Indicator				Monitor	Output terminal				
		RUN/RST	COMM	COMM1 COMM2	NORM1/ERR1 NORM2/ERR2		RUN	OUT1	OUT2	OUT3	OUT4
Test	Processing communications	○	●	○	●	—	ON	—	—	—	—
	Communications processing interval	○	●	●	●	—	ON	—	—	—	—
	Communications normal	○	●	●	○	End code	ON	—	—	—	—
	Communications error	○	●	●	○	Error code	ON	—	—	—	—
RUN	Waiting for data send/receive	○	●	●	●	—	ON	—	—	—	—
	Sending/receiving data	○	○	○	●	—	ON	OFF	OFF	OFF	OFF
	Communications normal	○	●	●	○	End code	ON	USR	USR	USR	USR
	Host communications error	○	○	●	●	Error code	ON	OFF	OFF	OFF	OFF
	Communications error	○	●	●	○	Error code	ON	OFF	OFF	OFF	OFF
Fatal error	CPU error	●	●	●	●	—	OFF	OFF	OFF	OFF	OFF
	Antenna power supply error	○	○	●	●	92	ON	OFF	OFF	OFF	OFF
	Internal memory error	●	○	●	●	93	OFF	OFF	OFF	OFF	OFF
Emergency stop	External reset input ON	○	●	●	●	—	OFF	OFF	OFF	OFF	OFF

● : Not lit   ○ : Lit green   ○ : Lit yellow   ○ : Lit red  
 USR: Set with a CONTROLLER CONTROL command.

## Error Lists

### V680 Commands

#### ■ Communications Errors

Type	Error code	Name	Details	
Host communications error	10	Parity error	Communications error between host device and ID Controller <ul style="list-style-type: none"> <li>• Incorrect communications format settings</li> <li>• Malfunction due to noise</li> </ul>	
	11	Framing error		
	12	Overrun error		
		13	FCS error	Incorrect calculation of FCS
		14	Command input error	Incorrect command format
		15	Execution status error	<ul style="list-style-type: none"> <li>• A communications command was received by an Antenna executing a polling command.</li> <li>• A COPY (CP) command was received by an Antenna processing polling.</li> <li>• A WRITE REPEAT (RP) command was received but there is no write command in memory.</li> <li>• A COMMAND PROCESS TERMINATE (AA) command was received but there is no command to terminate.</li> <li>• A POLLING QUERY (PC) command was received although no polling processing has been started.</li> <li>• A SELF EXECUTION START (MO) command was received but no operation conditions have been set.</li> <li>• A PARAMETER SET (SP) command was received when executing a Tag communications command.</li> <li>• OPERATION CONDITION SET (SE) commands were executed in the wrong order.</li> </ul>
		18	Frame length error	The number of characters per command frame exceeds the specified value.
Tag communications error	70	Communications error	There is an error in communications between Antennas and Tags. <ul style="list-style-type: none"> <li>• Installation problem, e.g., travel speed through communications area or distance</li> <li>• Malfunction due to an obstruction.</li> </ul>	
	71	Mismatch error	Write has not been processed correctly.	
	72	Tag missing error	No Tag in communications area when read/write was executed.	
	7A	Address designation error	An address outside the Tag memory area has been designated. The area start address has not been correctly designated when using the MDS/MDL command.	
	7C	Amplifier error	<ul style="list-style-type: none"> <li>• Cannot communicate due to Amplifier error.</li> <li>• Amplifier not connected.</li> <li>• An Antenna other than the one specified by the V680-H01 Antenna connection setting is connected.</li> </ul>	
	7D	Write protection error	A write-protected area was specified for a write command.	

- Host communications errors are those that occur during communications between the host device and ID Controller.
- Tag communications errors are those that occur during communications between the ID Controller, Antennas, and Tags.
- The error details are all logged in the ID Controller memory and the error codes are displayed on the monitor display. Error data can be read using the READ ERROR INFORMATION (CF) command.

**Note 1.** If a Tag communications error (error code 70) or mismatch error (error code 71) occurs when a write command is executed, some or all of the data in the target addresses may have been overwritten. Overwritten data is not limited to data in the WRITE command. If an error (error code 70 or 71) occurs when a write command is executed, keep retrying the command from the host device until an error no longer occurs. Data at other addresses (i.e., not at the write addresses) is not affected.

2. An Amplifier error (error code 7C) will occur if an Amplifier is not connected to the ID Controller when using an Antenna with a Separate Amplifier. A Tag missing error (error code 72) will occur if the Antenna is not connected to the Amplifier.
3. If the Tag moves out of the communications area while a write command is being executed, all of the Tag data may not be written and a Tag communications error (error code 70) will occur.

Warning code	Name	Details
76	Tag overwrite count exceeded	Overwrite count exceeded warning for the OVERWRITE COUNT CONTROL (MDS/MDL) command
	Tag memory check error	Memory error detection warning for the DATA CHECK (MDC) command
	Data check error in READ TAG MEMORY ERROR CORRECTION command	The check code of the READ TAG MEMORY ERROR CORRECTION (QR) command is incorrect, and bit correction is not possible.
77	Data check warning in READ TAG MEMORY ERROR CORRECTION command	There is an error in the data read with the READ TAG MEMORY ERROR CORRECTION (QR) command, 1-bit error correction was performed, and the data check ended normally. The returned read data can be used as it is.

- This warning data is not stored in the ID Controller memory.

## ■ System Errors

Error code	Name	Details
92	Antenna internal power supply voltage error	There is an error in the power supply voltage supplied from the ID Controller to the Antennas. <ul style="list-style-type: none"> <li>• Have a spare ID Controller on hand.</li> </ul>
93	Internal memory error	Possible ID Controller error or noise error <ul style="list-style-type: none"> <li>• Cycle the power.</li> <li>• Turn ON reset input.</li> <li>• Set the communications conditions again with the SP command. (Have a spare ID Controller on hand in case the ID Controller does not recover normally.)</li> </ul>
9C	Antenna connection error: Power consumption too high V680-H01 connection setting error	Too many Antennas are connected or the specified power consumption has been exceeded. An Antenna other than the one specified by the V680-H01 Antenna connection setting is connected.

## V600 Commands

### ■ Communications Errors

Type	Error code	Name	Details
Host communications error	10	Parity error	Communications error between host device and ID Controller <ul style="list-style-type: none"> <li>• Incorrect communications format settings</li> <li>• Malfunction due to noise</li> </ul>
	11	Framing error	
	12	Overrun error	
	13	FCS error	Incorrect calculation of FCS
	14	Command input error	Incorrect command format
	18	Frame length error	The number of characters per command frame exceeds the specified value.
Tag communications error	70	Communications error	There is an error in communications between Antennas and Tags. <ul style="list-style-type: none"> <li>• Installation problem, e.g., travel speed through communications area or distance</li> <li>• Malfunction due to an obstruction.</li> </ul>
	71	Mismatch error	Write has not been processed correctly.
	72	Tag missing error	No Tag in communications area when read/write was executed.
	76	Copy error	Copy has not been processed correctly.
	7A	Address designation error	An address outside the Tag memory area has been designated. The area start address has not been correctly designated when using the MDS/MDL command.
	7C	Antenna error	Antenna has not been connected.
	7D	Write protection error	A write-protected area was specified for a write command.

- Host communications errors are those that occur during communications between the host device and ID Controller.
- Tag communications errors are those that occur during communications between the ID Controller, Antennas, and Tags.
- The error details are all logged in the ID Controller memory and the error codes are displayed on the monitor display. Error data can be read using the READ ERROR INFORMATION (CF) command.

- Note 1.** If a Tag communications error (error code 70), mismatch error (error code 71), or copy error (error code 76) occurs when a write command is executed, some or all of the data in the target addresses may have been overwritten. Overwritten data is not limited to data in the WRITE command. If an error (error code 70 or 71) or copy error (error code 76) occurs when a write command is executed, keep retrying the command from the host device until an error no longer occurs. Data at other addresses (i.e., not at the write addresses) is not affected.
2. An Amplifier error (error code 7C) will occur if an Amplifier is not connected to the ID Controller when using an Antenna with a Separate Amplifier. A Tag missing error (error code 72) will occur if the Antenna is not connected to the Amplifier.
  3. If the Tag moves out of the communications area while a write command is being executed, all of the Tag data may not be written and a Tag communications error (error code 70) will occur.

Warning code	Name	Details
76	Tag overwrite count exceeded	Overwrite count exceeded warning for the OVERWRITE COUNT CONTROL (MDS/MDL) command
	Tag memory check error	Memory error detection warning for the DATA CHECK (MDC) command

- This warning data is not stored in the ID Controller memory.

## ■ System Errors

Error code	Name	Details
92	Antenna internal power supply voltage error	The power supply voltage supplied from the ID Controller to the Antennas has dropped. <ul style="list-style-type: none"><li>• Have a spare ID Controller on hand.</li></ul>
93	Internal memory error	Possible ID Controller error or noise error <ul style="list-style-type: none"><li>• Cycle the power.</li><li>• Turn ON reset input.</li><li>• Set the communications conditions again with the SP command. (Have a spare ID Controller on hand in case the ID Controller does not recover normally.)</li></ul>

# Errors and Countermeasures

The four main causes of problems that may occur in the V680 Series are as follows:

- Noise interference.....Take adequate countermeasures against noise.
  - External device failure
  - ID Controller failure
  - Others
- } .....Repairs are required.

## ■ Noise Interference

If the system malfunctions due to noise, refer to the following table and take appropriate countermeasures.

No.	Occurrence of fault	Possible cause	Countermeasure
1	Occurs when a heavy-duty motor, transformer, or capacitor is turned ON.	An instantaneous voltage drop due to inrush current to the heavy load.  Common mode noise as a result of the above cause.	Increase the capacity of the power supply and the size of the power cable.  <ul style="list-style-type: none"> <li>• Provide the power through a 1-to-1 non-grounded insulating transformer.</li> <li>• Do not use the same ground as other large-capacity devices. Independently ground the Controller at a resistance of 100 Ω or less. (See figure 1.)</li> </ul>
2	Occurs irregularly.	Noise on power line	Provide the power through a 1-to-1 non-grounded insulating transformer or noise filter. (See figure 2.)
3	Malfunction such as input signal turning ON when it should be OFF.	Inductive noise on input line	<ul style="list-style-type: none"> <li>• Separate input signal from power lines.</li> <li>• If there is a lot of noise interference, put the input line inside a grounded metal conduit or use shielded cable.</li> </ul>

Figure 1:  
Improvement in Grounding

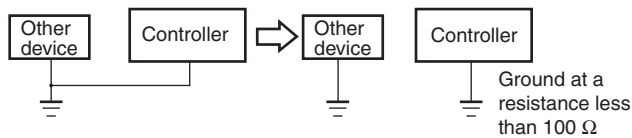
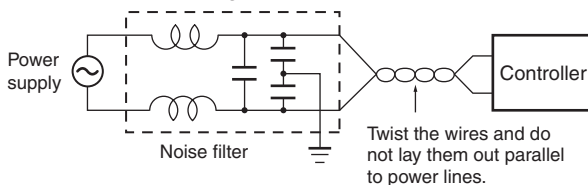

Figure 2:  
Countermeasures Against Noise on Power Line



## Maintenance and Inspection

The V680 Series must be inspected on a daily or regular basis so that the functions of the V680 Series can be used in good condition.

The V680 Series consists of semiconductors that last almost indefinitely. The following malfunctions may, however, result due to the operating environment and conditions.

1. Element deterioration due to overvoltage or overcurrent.
2. Element deterioration due to continuous stress caused by high ambient temperature.
3. Connector contact faults or insulation deterioration due to humidity and dust.
4. Connector contact faults or element corrosion due to corrosive gas.

### ■ Inspection Items

No.	Item	Detail	Criteria	Required equipment
1	Supply voltage fluctuation	Check that the supply voltage fluctuation at the power supply terminal block is within the permissible range.	Within supply voltage specified range	Multimeter
		Check that there are no frequent instantaneous power failures or radical voltage fluctuations.	Within permissible voltage fluctuation range	Power supply analyzer
2	Ambient environment			Maximum and minimum thermometer Hygrometer
	1) Temperature	1) Within the specified range	1) -10 to 55°C	
	2) Humidity	2) Within the specified range	2) 25% to 85%	
	3) Vibration and shock	3) Influence of vibration or impact of machines	3) Within the specified range	
	4) Dust	4) Check that the system is free of accumulated dust and foreign particles.	4) Neither is permitted.	
3	Panel condition			-
	1) Ventilation	1) Check that the system is ventilated properly with natural ventilation, forced ventilation, or cooling air.	1) The interior temperature must be within a range between -10 and 55°C with proper ventilation.	
4	2) Damage to packing for any enclosed construction	2) Check that the panel packing is properly attached with no damage.	2) The packing must have no damage.	Multimeter Oscilloscope
	I/O power supply	Check on the I/O terminal block that the voltage fluctuation and ripple are within the permissible ranges.	Within the specified range	
5	Mounting condition	Check that each device is securely mounted.	No loose screws	-
		Check that each connector is fully inserted.	Each connector must be locked or securely tightened with screws.	-
		Check that no screw of the terminal block is loose.	No loose screws	-
		Check that no wire is broken or nearly broken.	Must be no wire that is broken or nearly broken.	-
		Check that the distance between the Tag and Antenna is within the specified range.	Within the specified range	-
6	Tag life	Check the number of times the Tag has been written	Number of overwrites must not be exceeded	-
7	Error logging	Check error details	-	-

# Troubleshooting

If an error results, fully check the whole situation, determine the relationship between the system and any other device, and refer to the following flowcharts for troubleshooting procedures.

## Main Check Flowchart

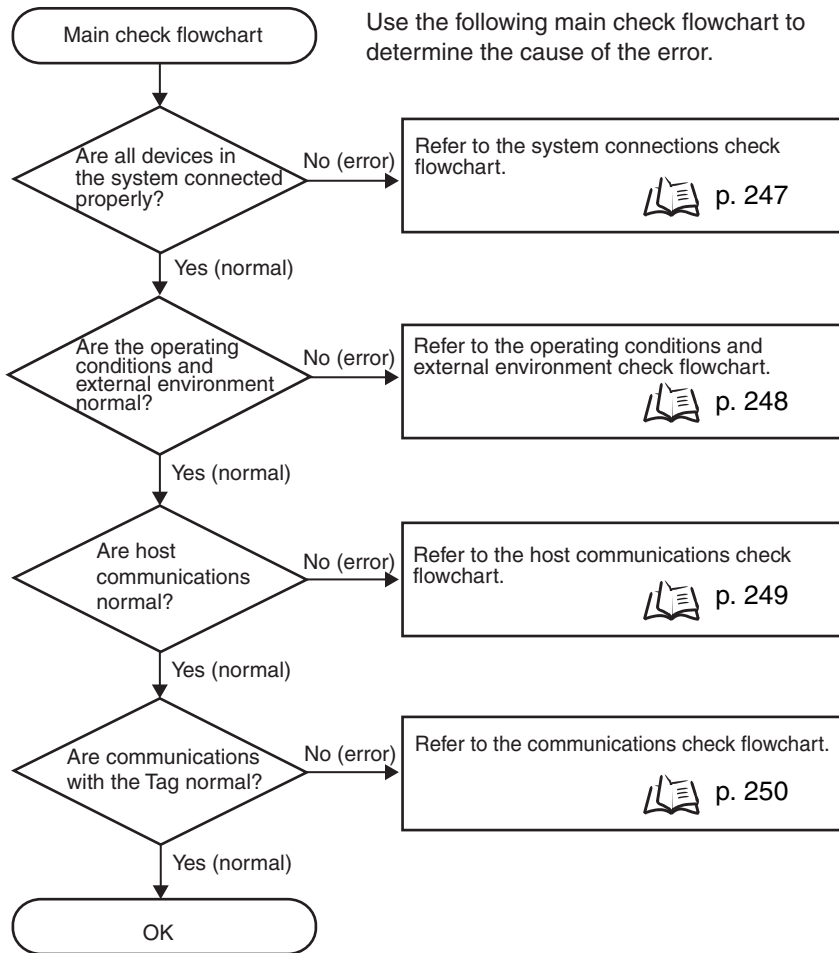



## System Connections Check Flowchart

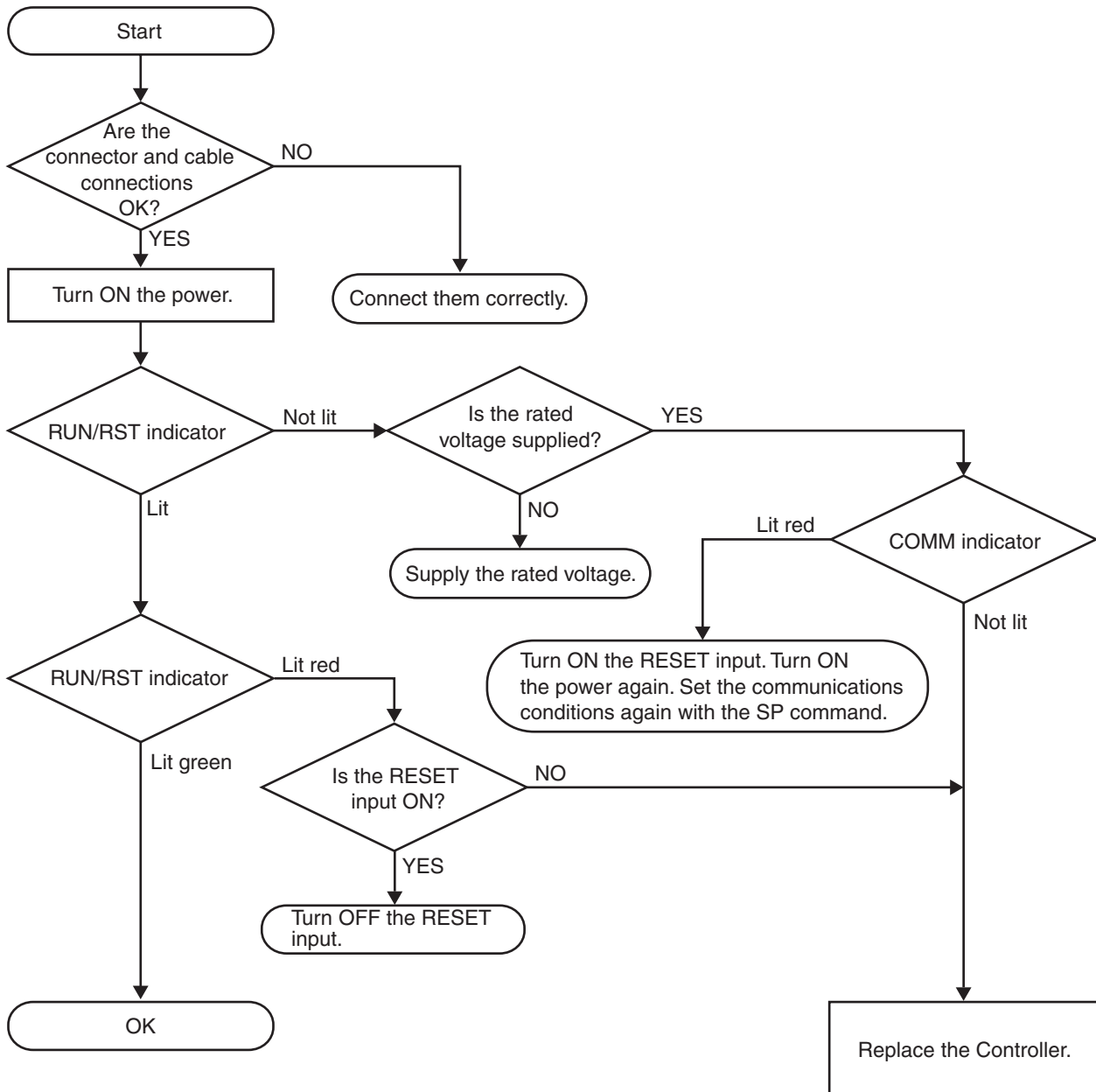

## Operating Conditions and External Environment Check Flowchart

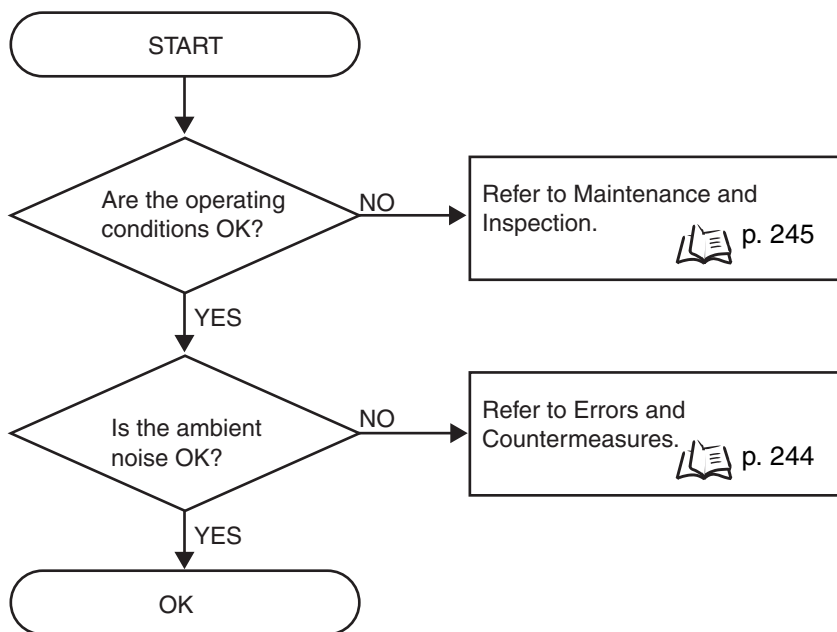

# Host Communications Check Flowchart

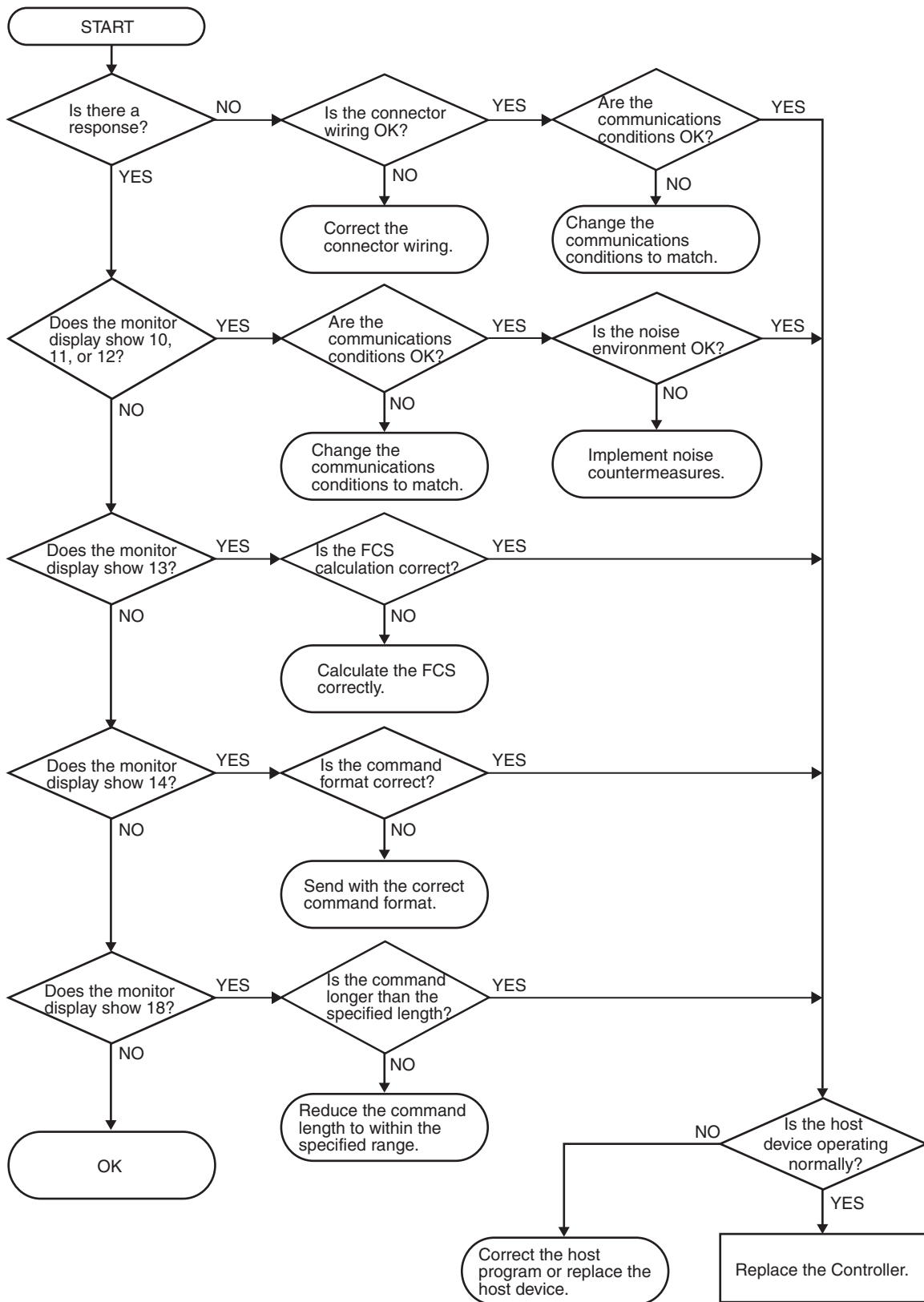

# Tag Communications Check Flow

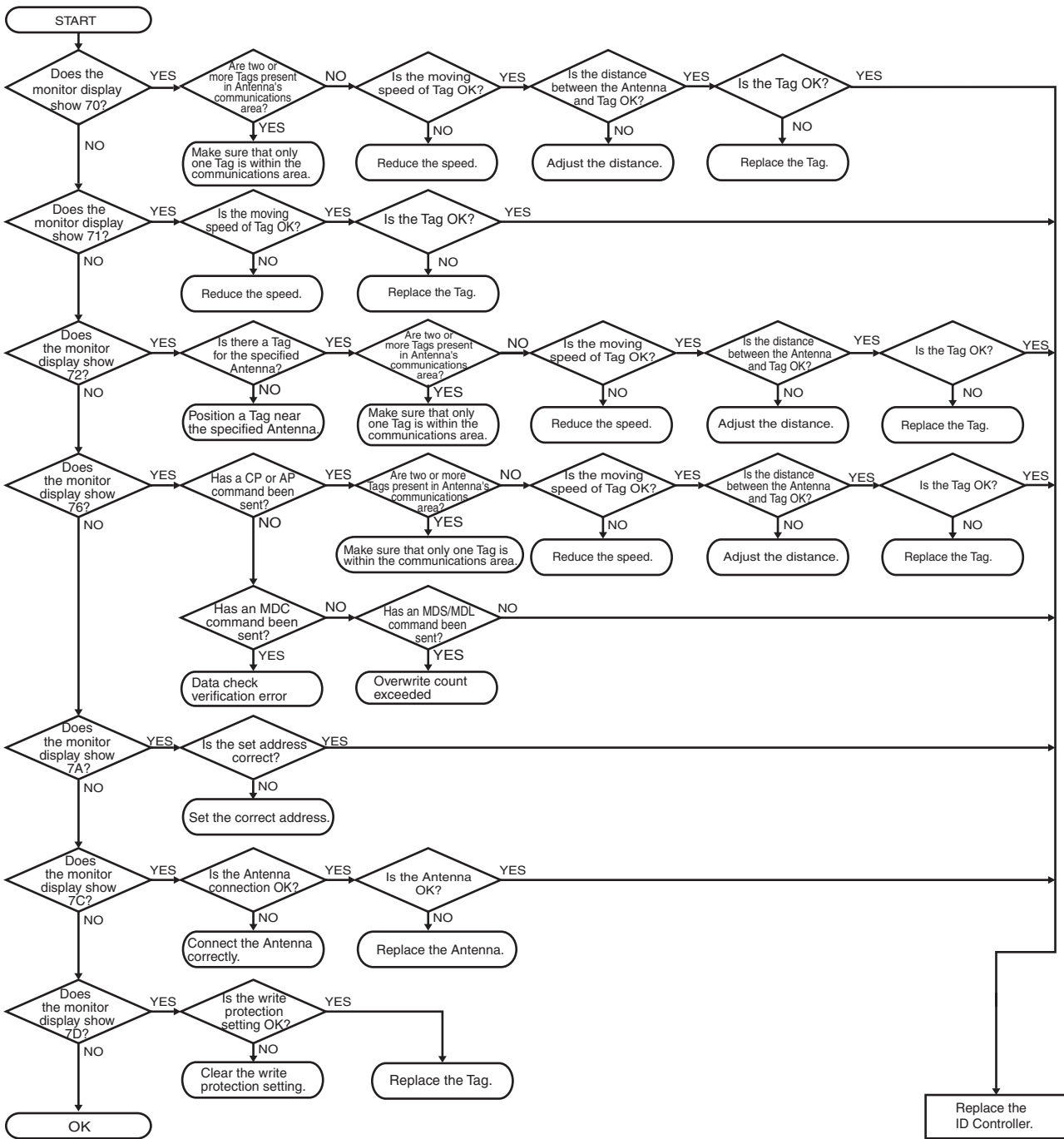

SECTION 6 Troubleshooting

# SECTION 7

## Appendices

☒ Specifications and Dimensions	252
☒ Characteristics According to Operating Conditions	256
☒ Tag Memory Map	265
☒ Tag Memory Capacity and Memory Type	266
☒ ASCII Table	267
☒ Degree of Protection	268

# Specifications and Dimensions

## General Specifications

Item	Specifications
Supply voltage (power consumption)	24 VDC +10%/–15% (15 W max., 0.8 A max.)
Ambient operating temperature	–10 to 55°C (with no icing)
Ambient operating humidity	25% to 85% (with no condensation)
Ambient storage temperature	–25 to 65°C (with no icing)
Ambient storage humidity	25% to 85% (with no condensation)
Insulation resistance	20 MΩ min. (at 500 VDC) between power supply terminals and casing and between the ground and power supply terminals
Dielectric strength	1000 VAC (50/60 Hz) for 1 minute between power supply terminals and casing and between the ground and power supply terminals
Vibration resistance	Destruction: 10 to 150 Hz, 0.2-mm double amplitude at 15 m/s <sup>2</sup> in X, Y, and Z directions ten sweeps each for 8 minutes
Shock resistance	150 m/s <sup>2</sup>
Dimensions	105 × 90 × 65 mm (excluding protruding parts)
Degree of protection	Panel-mounting (conforms to IP20)
Material	PC/ABS resin
Weight	Approx. 300 g
Mounting method	DIN Track or M4 screws
Antennas	V680-CA5D01-V2:1ch V680-CA5D02-V2:2ch

## Communications Specifications

Item	Specifications	
	RS-232C	RS-422/RS-485
Connector specifications	9-pin D-sub connector socket; M2.6 lock screws	5-pin connector manufactured by Phoenix Contact: MC1.5/5GF-3.5
Communications method	Half-duplex serial	4-/2-wire half duplex serial
Baud rate	9,600 bps, 19,200 bps, 38,400 bps, or 115,200 bps	
Data length	7/8 bits	
Stop bit length	1/2 bits	
Error detection	Parity (even/odd/none)	
Cable length	15 m max.	Total length: 500 m max.

## I/O Specifications

### ● Input Specifications (RST, TRG, TRG2)

Input voltage	24 VDC +10% (including ripple) -15% (either PNP or NPN)
Input impedance	2.2 kΩ
Input current	10 mA typical (24 VDC)
ON voltage	19 V min.
OFF voltage	5 V max.
Input response time	70 ms max.

### ● Output Specifications (RUN, BUSY/OUT3, ERROR/OUT4, OUT1, OUT2)

Maximum switching capacity	24 VDC +10% (including ripple) -15% 100 mA, PhotoMOS relay output (either PNP or NPN)
Leakage current	100 μA max.
Residual voltage	2.0 V max.

Note 1. When the RST input turns ON, the CPU stops operation, the RST indicator lights, and the ERROR output is reset.

2. The transistor may be damaged if the output is short-circuited with no load.

## ■ Example Wiring to Input Devices

### ▪ Input Section

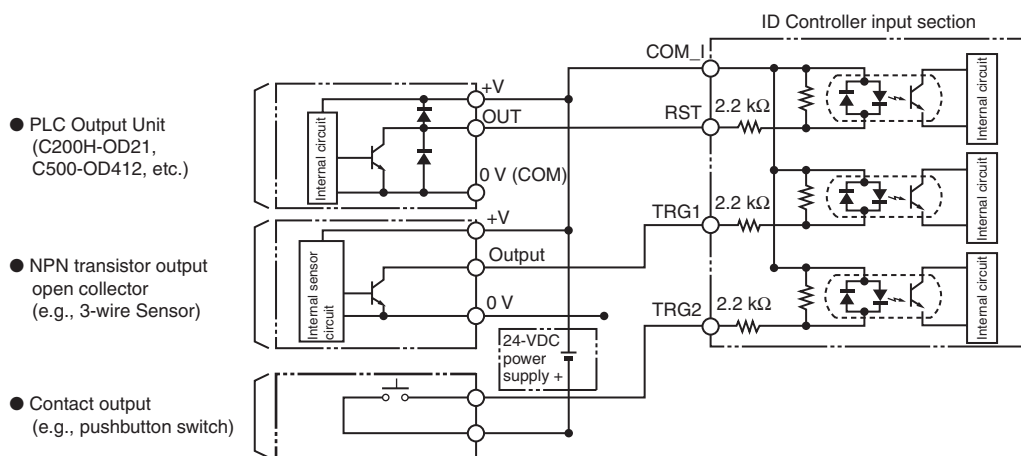

Output Section

● PLC Output Unit  
(C200H-ID212,  
C500-ID218, etc.)

● Relay

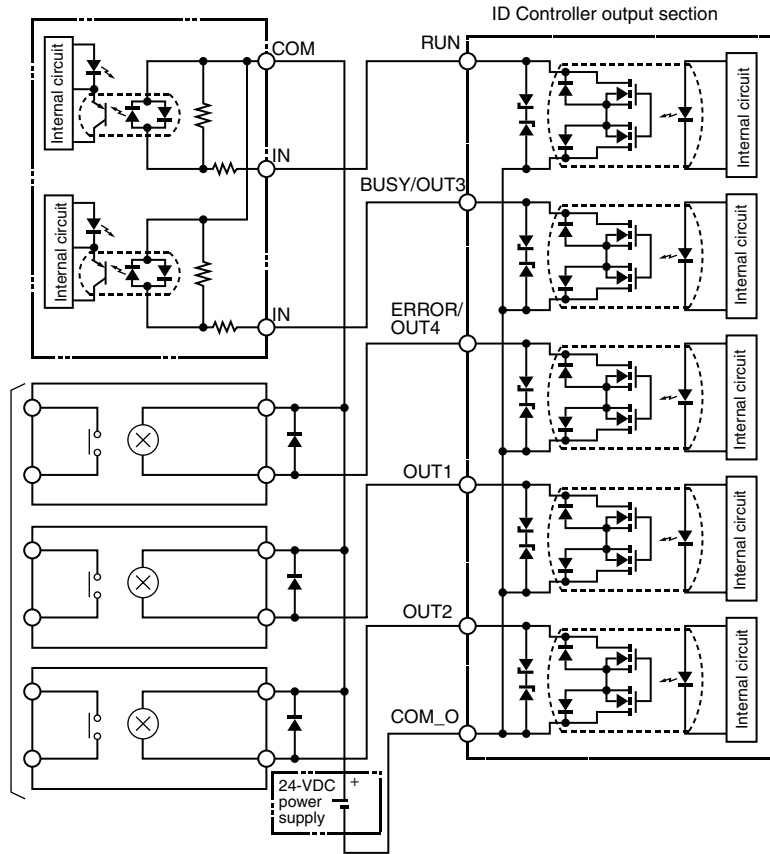



# Dimensions

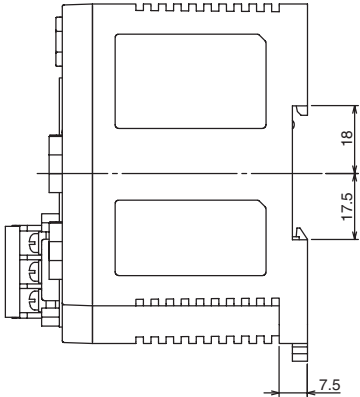
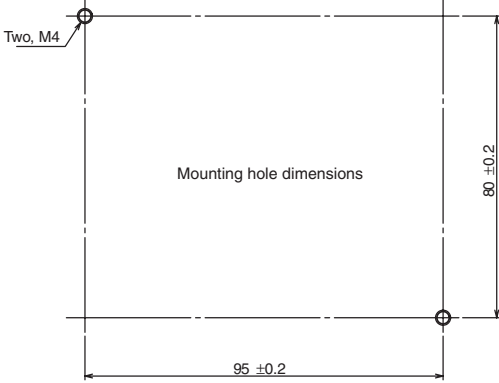
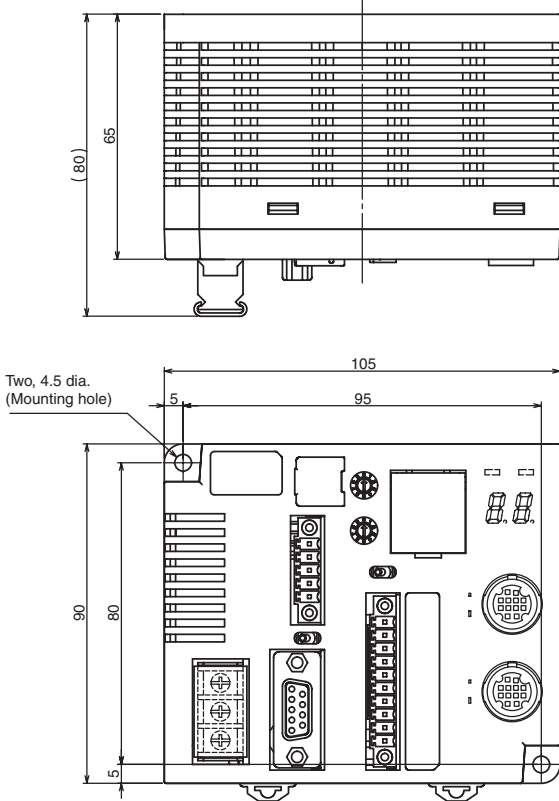

(Unit: mm)

# Characteristics According to Operating Conditions

## Communications Area (Reference)

The following diagram shows the communications area for the V680 Series. The communications area depends on the installation conditions and environmental conditions.

The following diagram shows the communications area when a Tag passes by and perpendicular to the center of the Antenna. The Antenna and Tag surfaces are parallel to each other.

● V680-HS63 & V680-D2KF67

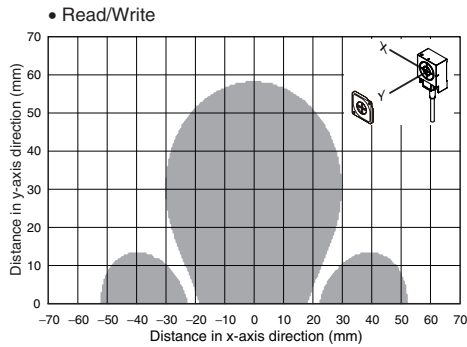

## Tag Communications Time and Turn Around Time (Reference)

### ■ Communications Time

V680-HA63A, V680-HS□□, V680-D1KP□□

V680-H01, V680-D1KP58HT

Communications speed setting	Command	Communications time N: No. of bytes processed
Normal mode	Read	$T = 1.3 N + 31$
	Write (with verification)	$T = 2.1 N + 58$
	Write (without verification)	$T = 1.8 N + 56$
High-speed mode (See note.)	Read	$T = 1.0 N + 29$
	Write (with verification)	$T = 1.8 N + 51$
	Write (without verification)	$T = 1.5 N + 47$

**Note:** The high-speed mode cannot be used with the V680-H01 Antenna.

When using multi-access or FIFO communications options, normal-mode communications speed will be used regardless of the high-speed mode setting.

**Communications speed: Normal mode**

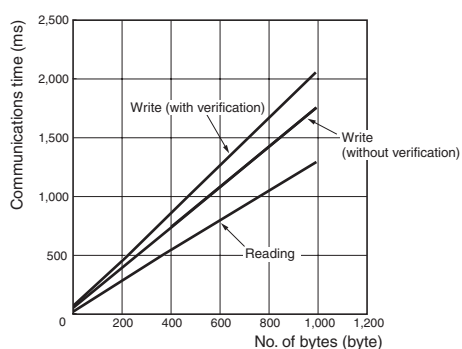

**Communications speed: high-speed mode**

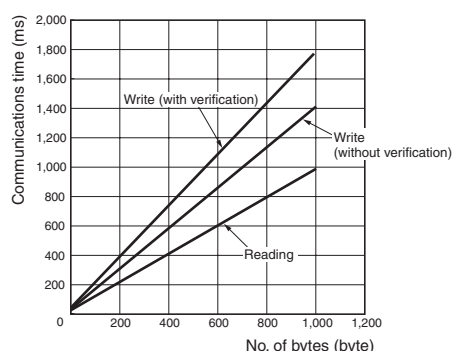

V680-HA63B, V680-HS□□, V680-D2KF□□

Communications speed setting	Command	Communications time N: No. of bytes processed
Normal mode	Read	$T = 1.2 N + 30$
	Write (with verification)	$T = 2.4 N + 49$
	Write (without verification)	$T = 1.2 N + 49$
High-speed mode (See note.)	Read	$T = 0.9 N + 27$
	Write (with verification)	$T = 1.7 N + 49$
	Write (without verification)	$T = 0.9 N + 41$

**Note:** When using multi-access or FIFO communications options, normal-mode communications speed will be used regardless of the high-speed mode setting.

**Communications speed: Normal mode**

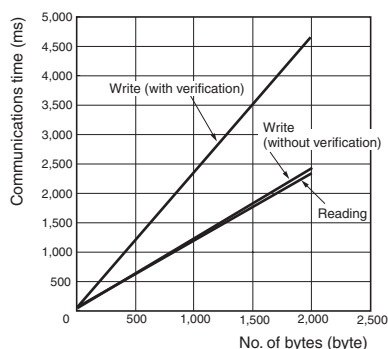

**Communications speed: high-speed mode**

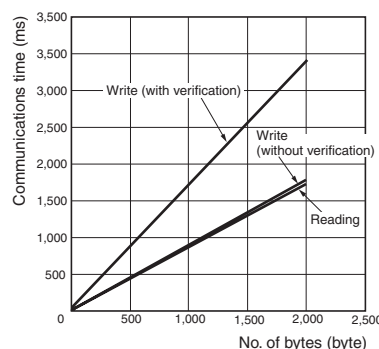

V680-HA63B, V680-HS□□, V680-D8KF□□, V680-D32KF□□

Communications speed setting	Command	Communications time N: No. of bytes processed
Normal mode	Read	$T = 1.3 N + 30$
	Write (with verification)	$T = 1.6 N + 59$
	Write (without verification)	$T = 1.3 N + 50$
High-speed mode (See note.)	Read	$T = 0.8 N + 25$
	Write (with verification)	$T = 1.1 N + 41$
	Write (without verification)	$T = 0.9 N + 40$

**Note:** When using multi-access or FIFO communications options, normal-mode communications speed will be used regardless of the high-speed mode setting.

**Communications speed: Normal mode**

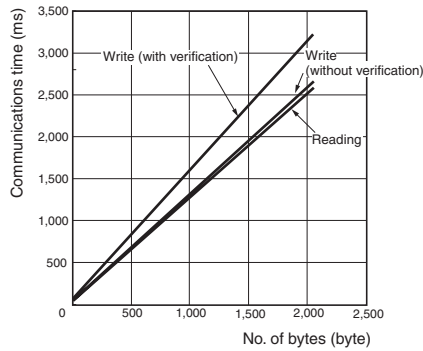

**Communications speed: High-speed mode**

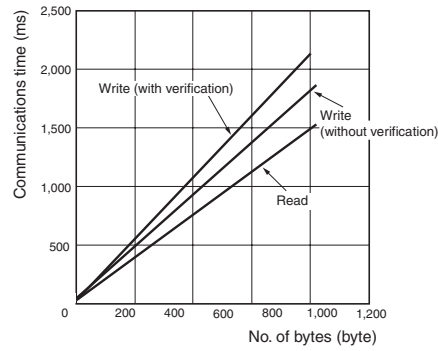

## ■ TAT (Turn Around Time)

- “TAT” is the total time from the start of command transmission by the host device (e.g., a personal computer) until a response is received by the host device.

$$\text{TAT} = \text{Command transmission time} + \text{Tag communications time} + \text{Response transmission time}$$

Command transmission time: The time required to send a command from the host device to the ID Controller. The command transmission time varies depending on the baud rate and the communications format.

Tag communications time: The processing time for communications between the Antenna and Tag. This is the value found above.

Response reception time: The time required to return a response from the ID Controller to the host device. The response reception time varies depending on the baud rate and the communications format.

### ■ Normal Commands

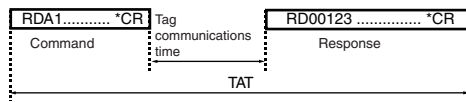

### ■ EXPANSION READ Command

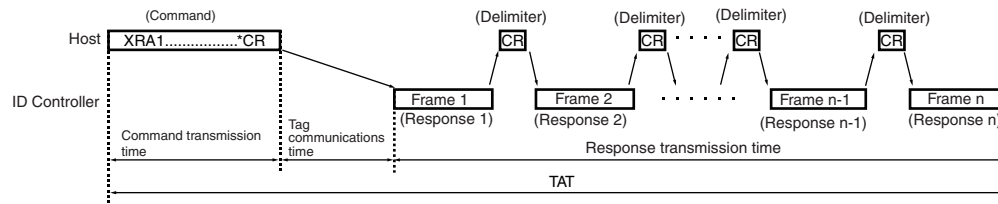

### ■ EXPANSION WRITE Command

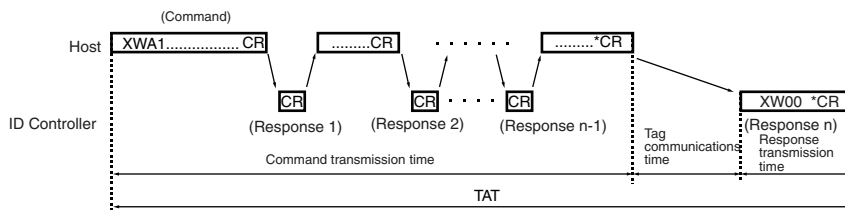

V680-HA63A, V680-HS□□, V680-D1KP□□, V680-H01, V680-D1KP58HT

Conditions	No. of bytes processed (byte)	9,600 bps (ms)	19,200 bps (ms)	38,400 bps (ms)	115,200 bps (ms)
Read Communications speed Normal mode	100	302	231	196	173
	256	684	524	443	389
	512	1,311	1,003	850	747
	1,000	2,501	1,921	1,621	1,431
Write With verification Communications speed Normal mode	100	409	338	303	280
	256	916	756	675	621
	512	1,748	1,440	1,287	1,184
	1,000	3,328	2,748	2,448	2,258
Write Without verification Communications speed Normal mode	100	377	306	271	248
	256	837	677	596	542
	512	1,592	1,284	1,131	1,028
	1,000	3,026	2,446	2,146	1,956
Read (See note 1.) Communications speed High-speed mode	100	270	199	164	141
	256	605	445	364	310
	512	1,155	847	694	591
	1,000	2,199	1,619	1,319	1,129
Write (See note 1.) With verification Communications speed High-speed mode	100	372	301	266	243
	256	832	672	591	537
	512	1,587	1,279	1,126	1,023
	1,000	3,021	2,441	2,141	1,951
Write (See note 1.) Without verification Communications speed High-speed mode	100	338	267	232	209
	256	751	591	510	456
	512	1,429	1,121	968	865
	1,000	2,717	2,137	1,837	1,647

- Note 1.** The V680-H01 Antenna cannot be used in high-speed mode because it will result in an error. When using multi-access or FIFO communications options, normal-mode communications speed will be used regardless of the high-speed mode setting.
- TAT data is for a V680-CA5D01/02-V2 ID Controller with the following communications settings: 8-bit data length, 1 stop bit, and odd parity. Data was sent continuously without breaks between characters.
  - The number of bytes for TAT data is when the code designation is set to ASCII.

V680-HA63B, V680-HS□□, V680-D2KF□□

Conditions	No. of bytes processed (byte)	9,600 bps (ms)	19,200 bps (ms)	38,400 bps (ms)	115,200 bps (ms)
Read Communications speed Normal mode	100	291	220	185	162
	256	658	498	417	363
	512	1,259	951	798	695
	1,000	2,400	1,820	1,520	1,330
	2,000	4,760	3,590	3,020	2,620
Write With verification Communications speed Normal mode	100	430	359	324	301
	256	984	824	743	689
	512	1,892	1,584	1,431	1,328
	1,000	3,619	3,039	2,739	2,549
	2,000	7,139	4,849	5,439	5,039
Write Without verification Communications speed Normal mode	100	310	239	204	181
	256	677	517	436	382
	512	1,278	970	817	714
	1,000	2,419	1,839	1,539	1,349
	2,000	4,779	2,449	3,039	2,639
Read (See note. 1) Communications speed High-speed mode	100	261	190	155	132
	256	581	421	340	286
	512	1,105	797	644	541
	1,000	2,100	1,520	1,220	1,030
	2,000	4,160	1,830	2,420	2,020
Write (See note 1.) With verification Communications speed High-speed mode	100	360	289	254	231
	256	805	645	564	510
	512	1,534	1,226	1,073	970
	1,000	2,919	2,339	2,039	1,849
	2,000	5,779	3,449	4,039	3,639
Write (See note 1.) Without verification Communications speed High-speed mode	100	272	201	166	143
	256	592	432	351	297
	512	1,116	808	655	552
	1,000	2,111	1,531	1,231	1,041
	2,000	4,171	1,841	2,431	2,031

- Note 1.** When using multi-access or FIFO communications options, normal-mode communications speed will be used regardless of the high-speed mode setting.
- TAT data is for a V680-CA5D01/02-V2 ID Controller with the following communications settings: 8-bit data length, 1 stop bit, and odd parity. Data was sent continuously without breaks between characters.
  - The number of bytes for TAT data is when the code designation is set to ASCII.

V680-HA63B, V680-HS□□, V680-D8KF□□, V680-D32KF□□

Conditions	No. of bytes processed (byte)	9,600 bps (ms)	19,200 bps (ms)	38,400 bps (ms)	115,200 bps (ms)
Read Communications speed Normal mode	100	301	230	195	172
	256	683	523	442	388
	512	1,310	1,002	849	746
	1,000	2,500	1,920	1,620	1,430
	2,000	4,960	2,630	3,220	2,820
Write With verification Communications speed Normal mode	100	360	289	254	231
	256	789	629	548	494
	512	1,493	1,185	1,032	929
	1,000	2,829	2,249	1,949	1,759
	2,000	5,589	3,259	3,849	3,449
Write Without verification Communications speed Normal mode	100	321	250	215	192
	256	703	543	462	408
	512	1,330	1,022	869	766
	1,000	2,520	1,940	1,640	1,450
	2,000	4,980	2,650	3,240	2,840
Read (See note 1.) Communications speed High-speed mode	100	246	175	140	117
	256	550	390	309	255
	512	1,049	741	588	485
	1,000	1,995	1,415	1,115	925
	2,000	3,955	1,625	2,215	1,815
Write (See note 1.) With verification Communications speed High-speed mode	100	292	221	186	163
	256	643	483	402	348
	512	1,219	911	758	655
	1,000	2,311	1,731	1,431	1,241
	2,000	4,571	2,241	2,831	2,431
Write (See note 1.) Without verification Communications speed High-speed mode	100	271	200	165	142
	256	591	431	350	296
	512	1,115	807	654	551
	1,000	2,110	1,530	1,230	1,040
	2,000	4,170	1,840	2,430	2,030

**Note 1.** When using multi-access or FIFO communications options, normal-mode communications speed will be used regardless of the high-speed mode setting.

2. TAT data is for a V680-CA5D01/02-V2 ID Controller with the following communications settings: 8-bit data length, 1 stop bit, and odd parity. Data was sent continuously without breaks between characters.
3. The number of bytes for TAT data is when the code designation is set to ASCII.



## Calculating Tag Speed

When communicating with a moving Tag, specify an AUTO command or POLLING command. The maximum speed for communicating with the Tag can be calculated simply using the following formula.

$$\text{Maximum speed} = \frac{D \text{ (Distance travelled in communications area)}}{T \text{ (Communications time)}}$$

D (Distance travelled in communications area) is calculated from the actual measurement or the communications area between the Antenna and Tag.

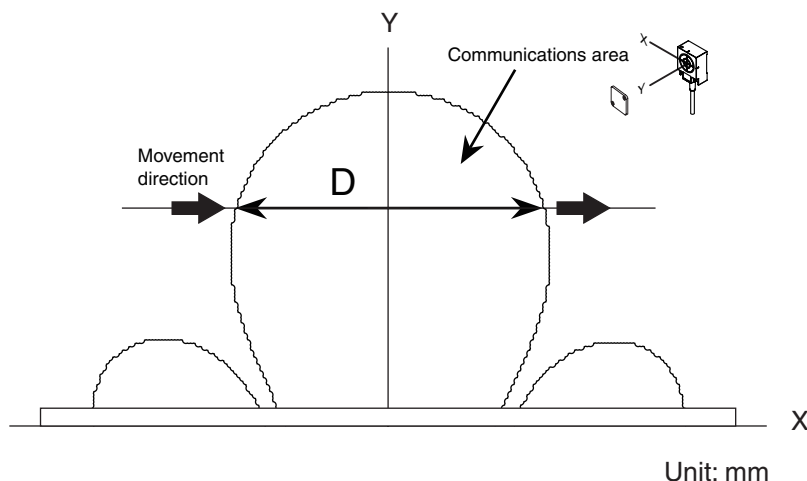

### Calculation Example

The following example is for reading 256 bytes with the V680-D2KF67, V680-HA63, and V680-HS63, using normal mode for the Controller communications speed.

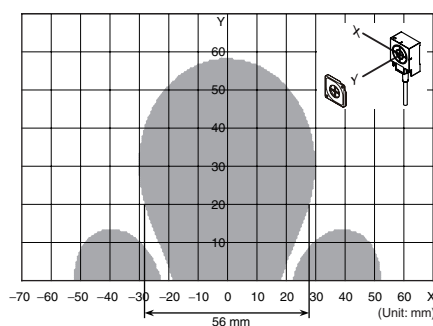

From the above chart,

Distance travelled in communications area = 56 mm when Y (communications distance) is 20 mm

Communications time T = 337.2 ms (calculated from the communications time on page 257, i.e.,  $1.2 \times 256 \text{ bytes} + 30$ )

Therefore, the maximum speed of the Tag is as follows:

$$\begin{aligned} \text{Maximum speed} &= \frac{D \text{ (Distance travelled in communications area)}}{T \text{ (Communications time)}} = \frac{56 \text{ (mm)}}{337.2 \text{ (ms)}} \\ &= 10.04 \text{ m/min} \end{aligned}$$

- Note** 1. The distance travelled in the communications area depends on the read/write distance and axis deflection. Refer to the *Communications Area (Reference)*.  
Refer to *V680 Series User's Manual for Amplifiers, Antennas, and ID Tags (EEPROM)*, Cat. No. Z262, and *V680 Series User's Manual for Amplifiers, Antennas, and ID Tags (FRAM)*, Cat. No. Z248.
2. The maximum speed calculated here is a guideline. Always test actual performance in advance.
  3. Error processing for communications with the host device and Tag communications is not considered in the above calculations.

## Tag Memory Map

### ■ Memory Map for the V680-D1KP□□

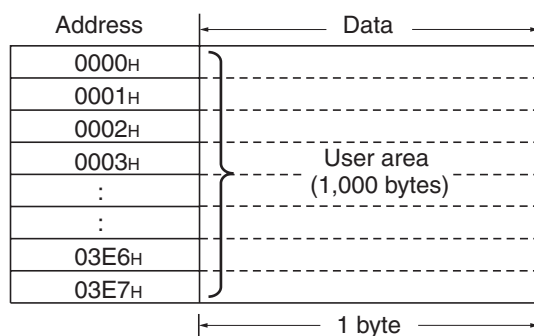

### ■ Memory Map for the V680-D2KF□□

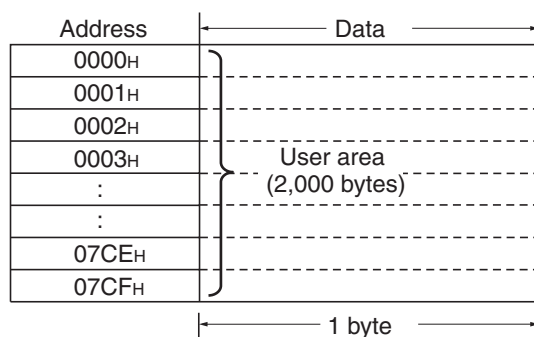

### ■ Memory Map for the V680-D8KF68

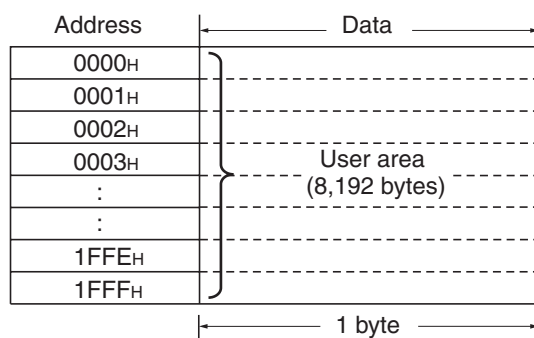

### ■ Memory Map for the V680-D32KF68

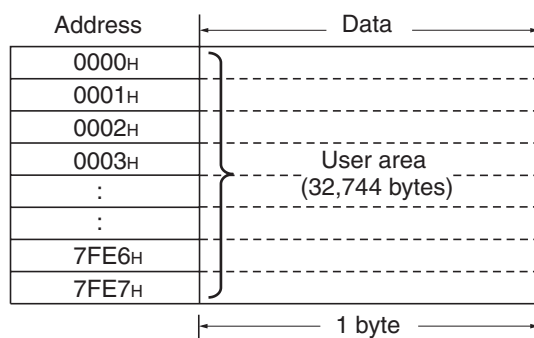

For information on memory capacity and memory types, refer to *Tag Memory Capacity and Memory Type*.

# Tag Memory Capacity and Memory Type

(As of April 2008)

Model	Memory capacity (user memory)	Memory type	Life expectancy
V680-D1KP52MT V680-D1KP66T V680-D1KP66T-SP V680-D1K66MT	1,000 bytes	EEPROM	<ul style="list-style-type: none"> <li>• Rewrite cycles: 100,000 cycles for each address (25°C)</li> <li>• Data backup: 10 years (at 85°C max.)</li> </ul>
V680-D1K58HT			<ul style="list-style-type: none"> <li>• Rewrite cycles: 100,000 cycles for each address</li> <li>• Data backup: 10 years</li> </ul> <p><b>Note:</b> The data storage time at high temperatures (exceeding 110°C) is 10 accumulative hours.</p>
V680-D2KF52M V680-D2KF67 V680-D1KF67M	2,000 bytes	FRAM	<ul style="list-style-type: none"> <li>• No. of accesses: 10 billion</li> <li>• Data backup: 10 years (at 55°C)</li> </ul>
V680-D8KF68	8,192 bytes		
V680-D32KF68	32,744 bytes		

Note: Refer to the following manuals for more details.

Model	Manual name	Cat. No.
V680-D1KP52MT V680-D1KP66T V680-D1KP66T-SP V680-D1KP66MT	<i>V680 Series User's Manual for Amplifiers, Antennas, and ID Tags (EEPROM)</i>	Z262
V680-D1KP58HT	<i>V680 Series User's Manual for Heat-resistant RFID Systems</i>	Z221
V680-D2KF52M V680-D2KF67 V680-D1KF67M V680-D8KF68 V680-D32KF68	<i>V680 Series User's Manual for Amplifiers, Antennas, and ID Tags (FRAM)</i>	Z248

# ASCII Table

Leftmost digit Rightmost digit	b8 to b5	0000	0001	0010	0011	0100	0101	0110	0111	1000	1001	1010	1011	1100	1101	1110	1111
	b4 to b1	Column Row	0	1	2	3	4	5	6	7	8	9	10	11	12	13	14
0000	0	NUL	TC7(DLE)	(SP)	0	@	P	`	p	Undefined	Undefined	Undefined	Undefined	Undefined	Undefined	Undefined	Undefined
0001	1	TC1(SOH)	DC1	!	1	A	Q	a	q								
0010	2	TC2(STX)	DC2	"	2	B	R	b	r								
0011	3	TC3(ETX)	DC3	#	3	C	S	c	s								
0100	4	TC4(EOT)	DC4	\$	4	D	T	d	t								
0101	5	TC5(NEQ)	TC8(NAK)	%	5	E	U	e	u								
0110	6	TC6(ACK)	TC9(SYN)	&	6	F	V	f	v								
0111	7	BEL	TC10(ETB)	'	7	G	W	g	w								
1000	8	FE0(BS)	CAN	(	8	H	X	h	x								
1001	9	FE1(HT)	EM	)	9	I	Y	i	y								
1010	10	FE2(LF)	SUB	*	:	J	Z	j	z								
1011	11	FE3(VT)	ESC	+	;	K	[	k	{								
1100	12	FE4(FF)	IS4(FS)	,	<	L	\	l									
1101	13	FE5(CR)	IS3(GS)	-	=	M	]	m	}								
1110	14	SO	IS2(RS)	.	>	N	^	n	~								
1111	15	SI	IS1(US)	/	?	O	_	o	DEL								

- Note 1. The item in column 5, row 12 is a backslash (\) in ASCII.  
 2. Do not use undefined areas.

# Degree of Protection

Ingress protection degrees (IP-□□) are determined by the following tests. Be sure to check the sealing capability under the actual operating environment and conditions before actual use.

IP indicates the ingress protection symbol.

## ■ IEC (International Electrotechnical Commission) Standards IEC 60529: 1989-11

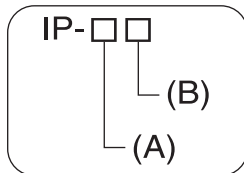









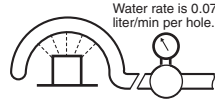

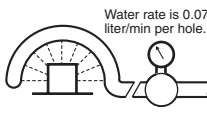
### (A) First Digit: Degree of Protection from Solid Materials

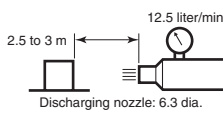
Degree	Degree	
0		No protection
1		Protects against penetration of any solid object such as a hand that is 50 mm or more in diameter.
2		Protects against penetration of any solid object, such as a finger, that is 12.5 mm or more in diameter.
3		Protects against penetration of any solid object, such as a wire, that is 2.5 mm or more in diameter.
4		Protects against penetration of any solid object, such as a wire, that is 1 mm or more in diameter.
5		Protects against penetration of dust of a quantity that may cause malfunction or obstruct the safe operation of the product.
6		Protects against penetration of all dust.

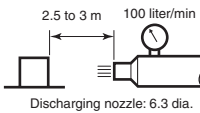
### (B) Second Digit: Degree of Protection Against Water

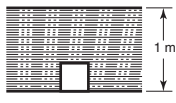
Degree	Protection		Test method (with pure water)
0	No protection	Not protected against water.	No test
1	Protection against water drops	Protects against vertical drops of water towards the product.	Water is dropped vertically towards the product from the test machine for 10 min. 
2	Protection against water drop	Protects against drops of water approaching at a maximum angle of 15° to the left, right, back, and front from vertical towards the product.	Water is dropped for 2.5 min each (i.e., 10 min in total) towards the product inclined 15° to the left, right, back, and front from the test machine. 

Degree	Protection	Test method (with pure water)
3	Protection against sprinkled water 	Protects against sprinkled water approaching at a maximum angle of 60° from vertical towards the product. Water is sprinkled for 10 min at a maximum angle of 60° to the left and right from vertical from the test machine. 
4	Protection against water spray 	Protects against water spray approaching at any angle towards the product. Water is sprayed at any angle towards the product for 10 min from the test machine. 
5	Protection against water jet spray 	Protects against water jet spray approaching at any angle towards the product. Water is jet sprayed at any angle towards the product for 1 min per square meter for at least 3 min in total from the test machine. 
6	Protection against high pressure water jet spray 	Protects against high-pressure water jet spray approaching at any angle towards the product. Water is jet sprayed at any angle towards the product for 1 min per square meter for at least 3 min in total from the test machine. 
7	Protection underwater 	Resists the penetration of water when the product is placed underwater at specified pressure for a specified time. The product is placed 1 m deep in water (if the product is 850 mm max. in height) for 30 min. 
8	Protection underwater 	Can be used continuously underwater. The test method is determined by the manufacturer and user.

■ Oil resistance (OMRON in-house standard)

Protection	
Oil-resistant	No adverse affect from oil drops or oil spray approaching from any direction.
Oil-proof	Protects against penetration of oil drops or oil spray approaching from any direction.

Note: This OMRON in-house standard confirms resistance to cutting and other oils. It is equivalent to the former JEM standard.

# Revision History

---

A manual revision code appears as a suffix to the catalog number at the bottom of the front and rear pages.

Cat. No. Z249-E1-04

↑  
Revision code

Revision code	Date	Revised contents
01	November 2006	Original production
02	April 2007	Changed model numbers from V680-CA5D□□ to V680-CA5D□□-V2, added information on new functions, and updated relevant specifications and descriptions throughout the manual.
03	September 2007	Made wiring revision for connecting V680-HS65 via RS-422, and other minor revisions.
04	July 2008	Made revisions related to design changes. Added information on installing the USB driver for Vista.



# Terms and Conditions of Sale

1. **Offer; Acceptance.** These terms and conditions (these "Terms") are deemed part of all quotes, agreements, purchase orders, acknowledgments, price lists, catalogs, manuals, brochures and other documents, whether electronic or in writing, relating to the sale of products or services (collectively, the "Products") by Omron Electronics LLC and its subsidiary companies ("Omron"). Omron objects to any terms or conditions proposed in Buyer's purchase order or other documents which are inconsistent with, or in addition to, these Terms.
2. **Prices; Payment Terms.** All prices stated are current, subject to change without notice by Omron. Omron reserves the right to increase or decrease prices on any unshipped portions of outstanding orders. Payments for Products are due net 30 days unless otherwise stated in the invoice.
3. **Discounts.** Cash discounts, if any, will apply only on the net amount of invoices sent to Buyer after deducting transportation charges, taxes and duties, and will be allowed only if (i) the invoice is paid according to Omron's payment terms and (ii) Buyer has no past due amounts.
4. **Interest.** Omron, at its option, may charge Buyer 1-1/2% interest per month or the maximum legal rate, whichever is less, on any balance not paid within the stated terms.
5. **Orders.** Omron will accept no order less than \$200 net billing.
6. **Governmental Approvals.** Buyer shall be responsible for, and shall bear all costs involved in, obtaining any government approvals required for the importation or sale of the Products.
7. **Taxes.** All taxes, duties and other governmental charges (other than general real property and income taxes), including any interest or penalties thereon, imposed directly or indirectly on Omron or required to be collected directly or indirectly by Omron for the manufacture, production, sale, delivery, importation, consumption or use of the Products sold hereunder (including customs duties and sales, excise, use, turnover and license taxes) shall be charged to and remitted by Buyer to Omron.
8. **Financial.** If the financial position of Buyer at any time becomes unsatisfactory to Omron, Omron reserves the right to stop shipments or require satisfactory security or payment in advance. If Buyer fails to make payment or otherwise comply with these Terms or any related agreement, Omron may (without liability and in addition to other remedies) cancel any unshipped portion of Products sold hereunder and stop any Products in transit until Buyer pays all amounts, including amounts payable hereunder, whether or not then due, which are owing to it by Buyer. Buyer shall in any event remain liable for all unpaid accounts.
9. **Cancellation; Etc.** Orders are not subject to rescheduling or cancellation unless Buyer indemnifies Omron against all related costs or expenses.
10. **Force Majeure.** Omron shall not be liable for any delay or failure in delivery resulting from causes beyond its control, including earthquakes, fires, floods, strikes or other labor disputes, shortage of labor or materials, accidents to machinery, acts of sabotage, riots, delay in or lack of transportation or the requirements of any government authority.
11. **Shipping; Delivery.** Unless otherwise expressly agreed in writing by Omron:
  - a. Shipments shall be by a carrier selected by Omron; Omron will not drop ship except in "break down" situations.
  - b. Such carrier shall act as the agent of Buyer and delivery to such carrier shall constitute delivery to Buyer;
  - c. All sales and shipments of Products shall be FOB shipping point (unless otherwise stated in writing by Omron), at which point title and risk of loss shall pass from Omron to Buyer; provided that Omron shall retain a security interest in the Products until the full purchase price is paid;
  - d. Delivery and shipping dates are estimates only; and
  - e. Omron will package Products as it deems proper for protection against normal handling and extra charges apply to special conditions.
12. **Claims.** Any claim by Buyer against Omron for shortage or damage to the Products occurring before delivery to the carrier must be presented in writing to Omron within 30 days of receipt of shipment and include the original transportation bill signed by the carrier noting that the carrier received the Products from Omron in the condition claimed.
13. **Warranties.** (a) **Exclusive Warranty.** Omron's exclusive warranty is that the Products will be free from defects in materials and workmanship for a period of twelve months from the date of sale by Omron (or such other period expressed in writing by Omron). Omron disclaims all other warranties, express or implied. (b) **Limitations.** OMRON MAKES NO WARRANTY OR REPRESENTATION, EXPRESS OR IMPLIED, ABOUT NON-INFRINGEMENT, MERCHANTABILITY OR FITNESS FOR A PARTICULAR PURPOSE OF THE PRODUCTS. BUYER ACKNOWLEDGES THAT IT ALONE HAS DETERMINED THAT THE PRODUCTS WILL SUITABLY MEET THE REQUIREMENTS OF THEIR INTENDED USE. Omron further disclaims all warranties and responsibility of any type for claims or expenses based on infringement by the Products or otherwise of any intellectual property right. (c) **Buyer Remedy.** Omron's sole obligation hereunder shall be, at Omron's election, to (i) replace (in the form originally shipped with Buyer responsible for labor charges for removal or replacement thereof) the non-complying Product, (ii) repair the non-complying Product, or (iii) repay or credit Buyer an amount equal to the purchase price of the non-complying Product; provided that in no event shall Omron be responsible for warranty, repair, indemnity or any other claims or expenses regarding the Products unless Omron's analysis confirms that the Products were properly handled, stored, installed and maintained and not subject to contamination, abuse, misuse or inappropriate modification. Return of any Products by Buyer must be approved in writing by Omron before shipment. Omron Companies shall not be liable for the suitability or unsuitability or the results from the use of Products in combination with any electrical or electronic components, circuits, system assemblies or any other materials or substances or environments. Any advice, recommendations or information given orally or in writing, are not to be construed as an amendment or addition to the above warranty. See <http://www.omron247.com> or contact your Omron representative for published information.
14. **Limitation on Liability; Etc.** OMRON COMPANIES SHALL NOT BE LIABLE FOR SPECIAL, INDIRECT, INCIDENTAL, OR CONSEQUENTIAL DAMAGES, LOSS OF PROFITS OR PRODUCTION OR COMMERCIAL LOSS IN ANY WAY CONNECTED WITH THE PRODUCTS, WHETHER SUCH CLAIM IS BASED IN CONTRACT, WARRANTY, NEGLIGENCE OR STRICT LIABILITY. Further, in no event shall liability of Omron Companies exceed the individual price of the Product on which liability is asserted.
15. **Indemnities.** Buyer shall indemnify and hold harmless Omron Companies and their employees from and against all liabilities, losses, claims, costs and expenses (including attorney's fees and expenses) related to any claim, investigation, litigation or proceeding (whether or not Omron is a party) which arises or is alleged to arise from Buyer's acts or omissions under these Terms or in any way with respect to the Products. Without limiting the foregoing, Buyer (at its own expense) shall indemnify and hold harmless Omron and defend or settle any action brought against such Companies to the extent based on a claim that any Product made to Buyer specifications infringed intellectual property rights of another party.
16. **Property; Confidentiality.** Any intellectual property in the Products is the exclusive property of Omron Companies and Buyer shall not attempt to duplicate it in any way without the written permission of Omron. Notwithstanding any charges to Buyer for engineering or tooling, all engineering and tooling shall remain the exclusive property of Omron. All information and materials supplied by Omron to Buyer relating to the Products are confidential and proprietary, and Buyer shall limit distribution thereof to its trusted employees and strictly prevent disclosure to any third party.
17. **Export Controls.** Buyer shall comply with all applicable laws, regulations and licenses regarding (i) export of products or information; (ii) sale of products to "forbidden" or other proscribed persons; and (iii) disclosure to non-citizens of regulated technology or information.
18. **Miscellaneous.** (a) **Waiver.** No failure or delay by Omron in exercising any right and no course of dealing between Buyer and Omron shall operate as a waiver of rights by Omron. (b) **Assignment.** Buyer may not assign its rights hereunder without Omron's written consent. (c) **Law.** These Terms are governed by the law of the jurisdiction of the home office of the Omron company from which Buyer is purchasing the Products (without regard to conflict of law principles). (d) **Amendment.** These Terms constitute the entire agreement between Buyer and Omron relating to the Products, and no provision may be changed or waived unless in writing signed by the parties. (e) **Severability.** If any provision hereof is rendered ineffective or invalid, such provision shall not invalidate any other provision. (f) **Setoff.** Buyer shall have no right to set off any amounts against the amount owing in respect of this invoice. (g) **Definitions.** As used herein, "including" means "including without limitation"; and "Omron Companies" (or similar words) mean Omron Corporation and any direct or indirect subsidiary or affiliate thereof.

## Certain Precautions on Specifications and Use

1. **Suitability of Use.** Omron Companies shall not be responsible for conformity with any standards, codes or regulations which apply to the combination of the Product in the Buyer's application or use of the Product. At Buyer's request, Omron will provide applicable third party certification documents identifying ratings and limitations of use which apply to the Product. This information by itself is not sufficient for a complete determination of the suitability of the Product in combination with the end product, machine, system, or other application or use. Buyer shall be solely responsible for determining appropriateness of the particular Product with respect to Buyer's application, product or system. Buyer shall take application responsibility in all cases but the following is a non-exhaustive list of applications for which particular attention must be given:
  - (i) Outdoor use, uses involving potential chemical contamination or electrical interference, or conditions or uses not described in this document.
  - (ii) Use in consumer products or any use in significant quantities.
  - (iii) Energy control systems, combustion systems, railroad systems, aviation systems, medical equipment, amusement machines, vehicles, safety equipment, and installations subject to separate industry or government regulations.
  - (iv) Systems, machines and equipment that could present a risk to life or property. Please know and observe all prohibitions of use applicable to this Product.

NEVER USE THE PRODUCT FOR AN APPLICATION INVOLVING SERIOUS RISK TO LIFE OR PROPERTY OR IN LARGE QUANTITIES WITHOUT ENSURING THAT THE SYSTEM AS A WHOLE HAS BEEN DESIGNED TO ADDRESS THE RISKS, AND THAT THE OMRON'S PRODUCT IS PROPERLY RATED AND INSTALLED FOR THE INTENDED USE WITHIN THE OVERALL EQUIPMENT OR SYSTEM.
2. **Programmable Products.** Omron Companies shall not be responsible for the user's programming of a programmable Product, or any consequence thereof.
3. **Performance Data.** Data presented in Omron Company websites, catalogs and other materials is provided as a guide for the user in determining suitability and does not constitute a warranty. It may represent the result of Omron's test conditions, and the user must correlate it to actual application requirements. Actual performance is subject to the Omron's Warranty and Limitations of Liability.
4. **Change in Specifications.** Product specifications and accessories may be changed at any time based on improvements and other reasons. It is our practice to change part numbers when published ratings or features are changed, or when significant construction changes are made. However, some specifications of the Product may be changed without any notice. When in doubt, special part numbers may be assigned to fix or establish key specifications for your application. Please consult with your Omron's representative at any time to confirm actual specifications of purchased Product.
5. **Errors and Omissions.** Information presented by Omron Companies has been checked and is believed to be accurate; however, no responsibility is assumed for clerical, typographical or proofreading errors or omissions.

# OMRON

Automation...simple...powerful.

**OMRON ELECTRONICS LLC • THE AMERICAS HEADQUARTERS**

Schaumburg, IL USA • 847.843.7900 • 800.556.6766 • [www.omron247.com](http://www.omron247.com)

**OMRON CANADA, INC. • HEAD OFFICE**

Toronto, ON, Canada • 416.286.6465 • 866.986.6766 • [www.omron.ca](http://www.omron.ca)

**OMRON ELETRÔNICA DO BRASIL LTDA • HEAD OFFICE**

São Paulo, SP, Brasil • 55.11.2101.6300 • [www.omron.com.br](http://www.omron.com.br)

**OMRON ELECTRONICS MEXICO SA DE CV • HEAD OFFICE**

Apodaca, N.L. • 52.811.156.99.10 • [mela@omron.com](mailto:mela@omron.com)

Z249-E1-04

Note: Specifications are subject to change.

**OMRON ARGENTINA • SALES OFFICE**

Cono Sur • 54.11.4787.1129

**OMRON CHILE • SALES OFFICE**

Santiago 56.2206.4592

**OTHER OMRON LATIN AMERICA SALES**

56.2206.4592

© 2008 Omron Electronics LLC

Printed in U.S.A.