

ZG2 Series

**Smart Sensor
2D Profile Measuring Sensors**

USERS MANUAL

OMRON

Introduction

Thank you for purchasing the ZG2 series.

This manual provides information regarding functions, performance and operating methods that are required for using the ZG2.

When using the ZG2, be sure to observe the following:

- The ZG2 must be operated by personnel knowledgeable in electrical engineering.
- To ensure correct use, please read this manual thoroughly to deepen your understanding of the product.
- Please keep this manual in a safe place so that it can be referred to whenever necessary.

■ How to Switch the Display Language to English

Turn the power ON with the MENU key held down. This displays the display language selection screen.

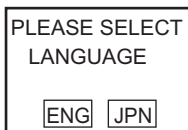

The Controller will start up with the messages displayed in English when it is next started up.

User's Manual

READ AND UNDERSTAND THIS DOCUMENT(Please Read)

BEFORE USE

1

BASIC OPERATIONS

2

FUNCTION SETTINGS

3

CONNECTION WITH EXTERNAL DEVICES

4

MEASUREMENT BY GANG-MOUNTED CONTROLLERS

5

APPENDICES

6

Smart Sensor

2D Profile Measuring Sensors
ZG2 Series

READ AND UNDERSTAND THIS DOCUMENT

Please read and understand this document before using the products. Please consult your OMRON representative if you have any questions or comments.

WARRANTY

OMRON's exclusive warranty is that the products are free from defects in materials and workmanship for a period of one year (or other period if specified) from date of sale by OMRON.

OMRON MAKES NO WARRANTY OR REPRESENTATION, EXPRESS OR IMPLIED, REGARDING NON-INFRINGEMENT, MERCHANTABILITY, OR FITNESS FOR PARTICULAR PURPOSE OF THE PRODUCTS. ANY BUYER OR USER ACKNOWLEDGES THAT THE BUYER OR USER ALONE HAS DETERMINED THAT THE PRODUCTS WILL SUITABLY MEET THE REQUIREMENTS OF THEIR INTENDED USE. OMRON DISCLAIMS ALL OTHER WARRANTIES, EXPRESS OR IMPLIED.

LIMITATIONS OF LIABILITY

OMRON SHALL NOT BE RESPONSIBLE FOR SPECIAL, INDIRECT, OR CONSEQUENTIAL DAMAGES, LOSS OF PROFITS OR COMMERCIAL LOSS IN ANY WAY CONNECTED WITH THE PRODUCTS, WHETHER SUCH CLAIM IS BASED ON CONTRACT, WARRANTY, NEGLIGENCE, OR STRICT LIABILITY.

In no event shall responsibility of OMRON for any act exceed the individual price of the product on which liability is asserted.

IN NO EVENT SHALL OMRON BE RESPONSIBLE FOR WARRANTY, REPAIR, OR OTHER CLAIMS REGARDING THE PRODUCTS UNLESS OMRON'S ANALYSIS CONFIRMS THAT THE PRODUCTS WERE PROPERLY HANDLED, STORED, INSTALLED, AND MAINTAINED AND NOT SUBJECT TO CONTAMINATION, ABUSE, MISUSE, OR INAPPROPRIATE MODIFICATION OR REPAIR.

SUITABILITY FOR USE

THE PRODUCTS CONTAINED IN THIS DOCUMENT ARE NOT SAFETY RATED. THEY ARE NOT DESIGNED OR RATED FOR ENSURING SAFETY OF PERSONS, AND SHOULD NOT BE RELIED UPON AS A SAFETY COMPONENT OR PROTECTIVE DEVICE FOR SUCH PURPOSES.

Please refer to separate catalogs for OMRON's safety rated products.

OMRON shall not be responsible for conformity with any standards, codes, or regulations that apply to the combination of products in the customer's application or use of the product.

At the customer's request, OMRON will provide applicable third party certification documents identifying ratings and limitations of use that apply to the products. This information by itself is not sufficient for a complete determination of the suitability of the products in combination with the end product, machine, system, or other application or use.

The following are some examples of applications for which particular attention must be given. This is not intended to be an exhaustive list of all possible uses of the products, nor is it intended to imply that the uses listed may be suitable for the products:

- Outdoor use, uses involving potential chemical contamination or electrical interference, or conditions or uses not described in this document.

- Nuclear energy control systems, combustion systems, railroad systems, aviation systems, medical equipment, amusement machines, vehicles, safety equipment, and installations subject to separate industry or government regulations.
- Systems, machines, and equipment that could present a risk to life or property.

Please know and observe all prohibitions of use applicable to the products.

NEVER USE THE PRODUCTS FOR AN APPLICATION INVOLVING SERIOUS RISK TO LIFE OR PROPERTY WITHOUT ENSURING THAT THE SYSTEM AS A WHOLE HAS BEEN DESIGNED TO ADDRESS THE RISKS, AND THAT THE OMRON PRODUCT IS PROPERLY RATED AND INSTALLED FOR THE INTENDED USE WITHIN THE OVERALL EQUIPMENT OR SYSTEM.

PERFORMANCE DATA

Performance data given in this document is provided as a guide for the user in determining suitability and does not constitute a warranty. It may represent the result of OMRON's test conditions, and the users must correlate it to actual application requirements. Actual performance is subject to the OMRON Warranty and Limitations of Liability.

CHANGE IN SPECIFICATIONS

Product specifications and accessories may be changed at any time based on improvements and other reasons.

It is our practice to change model numbers when published ratings or features are changed, or when significant construction changes are made. However, some specifications of the product may be changed without any notice. When in doubt, special model numbers may be assigned to fix or establish key specifications for your application on your request. Please consult with your OMRON representative at any time to confirm actual specifications of purchased products.

DIMENSIONS AND WEIGHTS

Dimensions and weights are nominal and are not to be used for manufacturing purposes, even when tolerances are shown.

ERRORS AND OMISSIONS

The information in this document has been carefully checked and is believed to be accurate; however, no responsibility is assumed for clerical, typographical, or proofreading errors, or omissions.

PROGRAMMABLE PRODUCTS

OMRON shall not be responsible for the user's programming of a programmable product, or any consequence thereof.

COPYRIGHT AND COPY PERMISSION

This document shall not be copied for sales or promotions without permission.

This document is protected by copyright and is intended solely for use in conjunction with the product. Please notify us before copying or reproducing this document in any manner, for any other purpose. If copying or transmitting this document to another, please copy or transmit it in its entirety.

Meanings of Signal Words

The following signal words are used in this manual.



Indicates a potentially hazardous situation which, if not avoided, will result in minor or moderate injury, or may result in serious injury or death. Additionally there may be significant property damage.

Meanings of Alert Symbols

The following alert symbols are used in this manual



Indicates general prohibitions for which there is no specific symbol.



Indicates the possibility of laser radiation.



Indicates prohibition when there is a risk of minor injury from electrical shock or other source if the product is disassembled.



This product is not designed or rated for ensuring safety of persons.
Do not use it for such purposes.



Never look into the laser beam. Doing so continuously will result in visual impairment.



Do not attempt to dismantle, pressurize, or incinerate the product. Doing so may cause the laser beam to leak, resulting in the danger of visual impairment.



Precautions for Safe Use

The following points are important to ensure safety, so make sure that they are strictly observed.

1. Installation Environment

- Do not use the product in environments where it can be exposed to inflammable/explosive gas.
- To secure the safety of operation and maintenance, do not install the product close to high-voltage devices and power devices.
- Install the product in such a way that its ventilation holes are not blocked.

2. Power Supply and Wiring

- The voltage and AC power supply must be within the rated range (DC 24 V \pm 10%).
- Reverse connection of the power supply is not allowed.
- Open-collector outputs should not be short-circuited.
- Use the power supply within the rated load.
- High-voltage lines and power lines must be wired separately from this product. Wiring them together or placing in the same duct may cause induction, resulting in malfunction or damage.
- Use the product within the power supply voltage specified by this manual.
- Use a DC power supply with safety measures against high-voltage spikes (safety extra low-voltage circuits on the secondary side).

3. Other

- Do not disassemble, repair, or modify the product.
- Dispose of this product as industrial waste.
- Connect the exclusive device (Sensor). The product might break down or malfunction if you use a part not included in the exclusive products.
- Should you notice any abnormalities, immediately stop use, turn OFF the power supply, and contact your OMRON representative.

Precautions for Correct Use

Observe the following precautions to prevent failure to operate, malfunctions, or undesirable effects on product performance.

1. Installation Site

Do not install this product in locations subjected to the following conditions:

- Ambient temperature outside the rating
- Rapid temperature fluctuations (causing condensation)
- Relative humidity outside the range of 35 to 85%
- Presence of corrosive or flammable gases
- Presence of dust, salt, or iron particles
- Direct vibration or shock
- Reflection of intense light (such as other laser beams or electric arc-welding machines)
- Direct sunlight or near heaters
- Water, oil, or chemical fumes or spray
- Strong magnetic or electric field

2. Power Supply and Wiring

- When using a commercially available switching regulator, make sure that the FG terminal is grounded.
- If surge currents are present in the power lines, connect surge absorbers that suit the operating environment.
- Before turning ON the power after the product is connected, make sure that the power supply voltage is correct, there are no incorrect connections (e.g. load short-circuit), and the load current is appropriate. Incorrect wiring may result in breakdown of the product.
- Before connecting/disconnecting devices, make sure that the Sensor/Controller is turned OFF. The Sensor or Controller may break down if it is connected/disconnected while the power is ON.
- Use the extension cable sold separately for extending the cable between the Sensor and the Controller.

 p.17

- Use only combinations of the Sensor and Controller specified in this manual.
- Before turning the Controller ON, connect the Sensor. If the Controller is turned ON without the Sensor connected, the Controller's screen will remain dark and messages cannot be read.

3. Warming Up

After turning the power supply ON, allow the product to stand for at least 30 minutes before use. The circuits are still unstable just after the power supply is turned ON, so measurement values may fluctuate gradually.

4. Maintenance and Inspection

Do not use thinner, benzene, acetone or kerosene to clean the Sensor and Controller. If large dust particles adhere to the filter on the front of the Sensor, use a blower brush (used to clean camera lenses) to blow them off. Do not use breath from your mouth to blow the dust off. To remove dust particles from the Sensor, wipe gently with a soft cloth (for cleaning lenses) moistened with a small amount of alcohol. Do not use excessive force to wipe off dust particles. Scratches to the filter might cause error.

5. Measurement Target

The measurement target is a non-transparent object. The sensor cannot detect the following types of objects accurately: materials with extremely small reflectances, objects smaller than the beam diameter, objects with large curvatures, or objects tilted to a large degree.

6. Effect of Peripheral Lighting

Do not install the Sensor in a place where strong light hits the laser emitter/receiver section of the Sensor.

Also, if a measurement target has a shiny surface, the light from the lighting will be reflected and a malfunction may occur. In such a case, prevent reflection by, for example, covering the light to stop reflection.



7. Compatibility of Measurement Data

Bank data or System data saved with existing ZG series cannot be processed by ZG2.

Editor's Note

■ Meaning of Symbols

Menu items that are displayed on the Controller's LCD screen, and windows, dialog boxes and other GUI elements displayed on the PC are indicated enclosed by brackets "[]".

■ Visual Aids

Important

Indicates points that are important to achieve the full product performance, such as operational precautions.

Note

Indicates application procedures.



Indicates pages where related information can be found.

CONTENTS

1. BEFORE USE

ZG2 Series	16
System Configuration	16
Part Names and Functions	18
Basic Knowledge for Operation	21
Profile Screen	21
Precautions when designing a production line	22
Measurement Range in Height Direction and Resolution	22
Trigger Measurement/Continuous Measurement	24
Mounting and Connecting Devices	27
Mounting the Sensor Head	27
Mounting the Controller	39
Connecting Devices	49
Overview of Settings and Measurement	52
Operation Modes	52
Tasks and Bank Data	53
STD Menu and EXP Menu	55
Initializing Controller Settings	56

2. BASIC OPERATIONS

Flow of Basic Setup	58
Starting Measurement	66
Monitoring the Measurement Status	66
Magnifying the Profile Display	67
Function Keys	68

3. FUNCTION SETTINGS

- Setting Measurement Conditions 70**
 - How to Select Measurement Items 70
 - Measuring Height 72
 - Measuring Step 74
 - Measuring Position and Width 77
 - Measuring Angle 79
 - Measuring Angle and Point of Intersection 80
 - Measuring Cross-sectional Area 82
 - Measuring Point of Inflection 83
 - Calculating Measurement Values 86
 - Deleting measurement items. 86
- Customizing Measurement Conditions 87**
 - Magnifying the Profile Display 87
 - Changing Measurement Positions. 88
 - Changing Measurement Points 89
 - Changing the Edge Level and Edge Direction. 90
- Scaling of Measurement Values 91**
- Image Adjustment. 96**
 - Adjusting Sensitivity. 96
 - Changing Sensitivity Adjustment Region. 99
 - Adjusting Profiles. 100
 - Adjusting the background filtering level. 104
 - Setting noise filtering 104
 - Setting the high-power mode (increasing the amount of emitted light) 105
 - Adjusting received light gain 105
- Position Correction 106**
 - Slope Correction 107
 - Height/Position Correction. 109
- Adjusting the Output Conditions of the Measurement Result. 111**
 - Setting the Average Number of Measurements 111
 - Setting Smoothing 111
 - Setting the Hold Function 112
- Setting Zero Reset 114**
 - Setting the Offset Value. 114

Executing Reference Zero Reset	115
Bank Settings	116
Bank Switching (change of device setup)	116
Copying Bank Data	116
Clearing Bank Data	117
System Settings	118
Setting the Sensor Head Installation Status	118
Sensor Head Inclination Correction.	118
Setting the CCD Mode.	121
Setting the Sensor Head Data Loading Method	121
Setting the Number of Digits Past the Decimal Point	122
Setting/Changing the ECO Display	122
Displaying the Controller Information	122
Setting/Changing the Display Language	123
Setting the Icon Color	123
Saving the Setup Data.	123

4. CONNECTION WITH EXTERNAL DEVICES

Output Data List	126
Using the Controller I/O Cable.	127
Wiring the Controller I/O Cable	127
Assignments and Functions of I/O Signal Wires	128
I/O Circuit Diagrams	130
Analog Output Settings	132
Setting for Measurement by the TRIG Signal	136
Setting for Switching Banks by the BANK Signal	136
Checking Signal Statuses	137
Setting the GATE Signal	137
Using the Parallel Output Unit (sold separately)	138
Connecting the Parallel Output Unit	138
Layout of Output Terminals	138
Output Circuit.	139
Output Format of Measurement Values	140
Output Format of Judgment Results	141
Assignment of Terminal Block Output	143

Setting the Number of Digits Past the Decimal Point	143
Setting GATE Signal at Parallel Output.	143
I/O Timing Charts	144
Serial Communication	149
Using the Serial Interface	149
Connecting Peripheral and External Devices	152
Serial Auto Output at Trigger Measurement	155
Setting Automatic Output.	155
Setting the RS-232C Communication Specifications	156
Setting the Node No.	156
About Communication Commands	157
Bank Control Commands	160
Measurement Control/Measurement Value Acquisition Commands	162
Setting Acquisition/Change Commands	165
Backup/Restore Commands	168
Utility commands.	172
Parameter List	176
Command Processing Time	181

5. MEASUREMENT BY GANG-MOUNTED CONTROLLERS

Mounting Order and Assignment of CH Numbers.	184
Setup Example	185
Measuring Wide Measurement Targets	185
Required Settings	187
Setting Mutual Interference Prevention	187
Settings Common to Gang-mounted Controllers.	189
Calculations Performed on Measurement Values Obtained on Multiple Channels.	190
I/O	191

6. APPENDICES

Specifications and External Dimensions	194
Sensor Head	194
Controller	203
Accessories	206
Error Messages and Corrective Actions	211
Troubleshooting	213
Menu List	216
List of Key Operations	218
Laser Safety	219
Classification	219
Label Replacement	219
Requirements from Regulations and Standards . .	222
Summary of Requirements to Manufactures	222
Summary of Requirements to User	226
Definitions of Laser Classification	229
Compliance with EC Directives	231
Updating the Firmware	232
Index	237
Revision History	240

BEFORE USE

ZG2 Series	16
Basic Knowledge for Operation	21
Precautions when designing a production line	22
Mounting and Connecting Devices	27
Overview of Settings and Measurement	52

ZG2 Series

Measurement by the ZG2 series can be started immediately merely by connecting the model of Sensor Head suited to the application to the Controller. Also, the ZG2 series can support various measurement applications by using it in combination with peripheral devices.

System Configuration

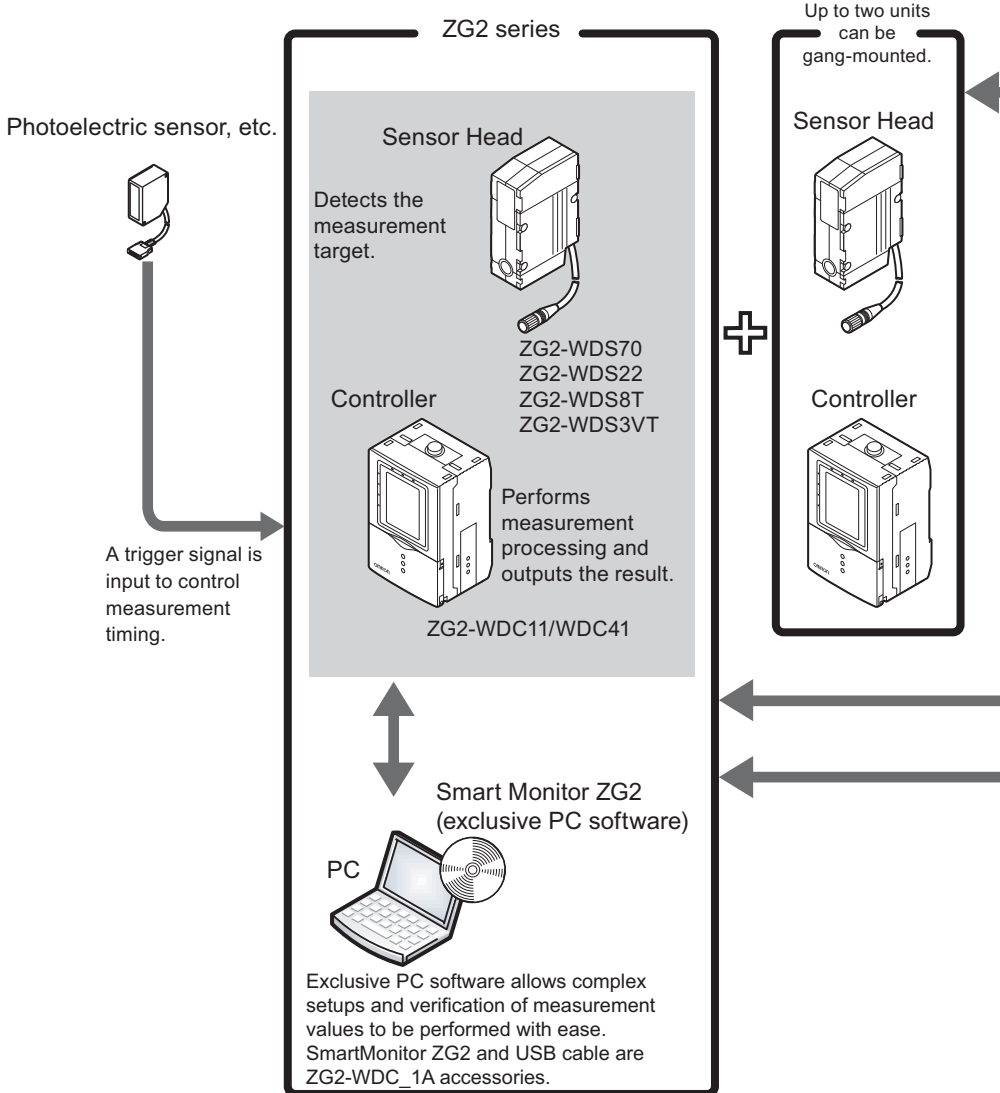

A USB connection allows measurement data to be captured easily on a PC. Also, the Controller can be controlled from a PC (e.g. switching/changing of setup data and input of measurement trigger).



PC

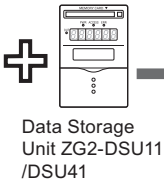

Measurement data can be collected and profiles saved. Also, up to 4096 banks* (16 banks x 256 files) of measurement conditions can be registered if the number of banks on the Controller is insufficient. A USB connection allows data to be captured on a PC. For details, refer to the ZG2-DSU User's Manual.

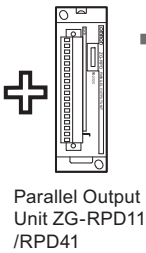

Measurement values and judgment results can be output at high speed on the parallel interface.

Measurement values and judgment results can be acquired, and the controller can be controlled (e.g. setup data can be switched/changed and measurement triggers can be input).



PLC

- RS-232C connector cable (option)
 - Exclusive cables are available to match the connected device.
- For PC: ZS-XRS2
For PLC/PT: ZS-XPT2

The analog signals of measurement values can be displayed as a waveform, and judgment results can be displayed in color.



Graphic Data Controller ZP-C

• Sensor Head-Controller extension cable (option)

Exclusive extension cables are available for extending the installation distance between the Sensor Head and the Controller.

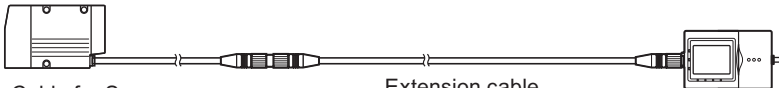

Cable for Sensor:
0.5 m, 2 m (flexible cable)

Extension cable
ZG2-XC__CR:
(3 m, 8 m, 15 m, 25 m) (flexible cable)

Part Names and Functions

Sensor Head

[ZG2-WDS70]

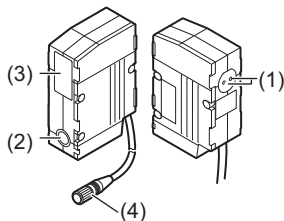

[ZG2-WDS8T/WDS22]

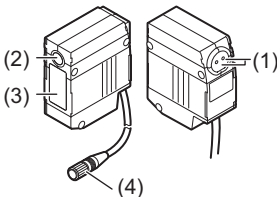

[ZG2-WDS3VT]

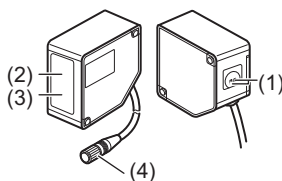

Name	Function														
(1) Laser indicator	<p>These are laser beam warning indicators. The “standby indicator (STANDBY)” indicates that the laser beam is ready for emission, and the “laser energized indicator (LD ON)” indicates that the laser is energized.</p> <p>Both indicators are OFF until Controller startup is completed after the power is turned ON.</p> <div style="text-align: center;"> </div> <table border="1" style="width: 100%; border-collapse: collapse;"> <thead> <tr> <th rowspan="2">Indicator</th> <th rowspan="2">At startup</th> <th colspan="2">RUN/ADJ/FUN mode</th> </tr> <tr> <th>LD OFF in progress</th> <th>LD ON in progress</th> </tr> </thead> <tbody> <tr> <td>Standby indicator (STANDBY)</td> <td>OFF</td> <td>ON</td> <td>ON</td> </tr> <tr> <td>Laser indicator (LD ON)</td> <td>OFF</td> <td>OFF</td> <td>ON</td> </tr> </tbody> </table>	Indicator	At startup	RUN/ADJ/FUN mode		LD OFF in progress	LD ON in progress	Standby indicator (STANDBY)	OFF	ON	ON	Laser indicator (LD ON)	OFF	OFF	ON
Indicator	At startup			RUN/ADJ/FUN mode											
		LD OFF in progress	LD ON in progress												
Standby indicator (STANDBY)	OFF	ON	ON												
Laser indicator (LD ON)	OFF	OFF	ON												
(2) Laser emitter	This emits the laser for measurement.														
(3) Laser receiver	This receives the laser light reflected from the measurement target.														
(4) Connector	This is the connector for connecting to the Controller.														

Controller

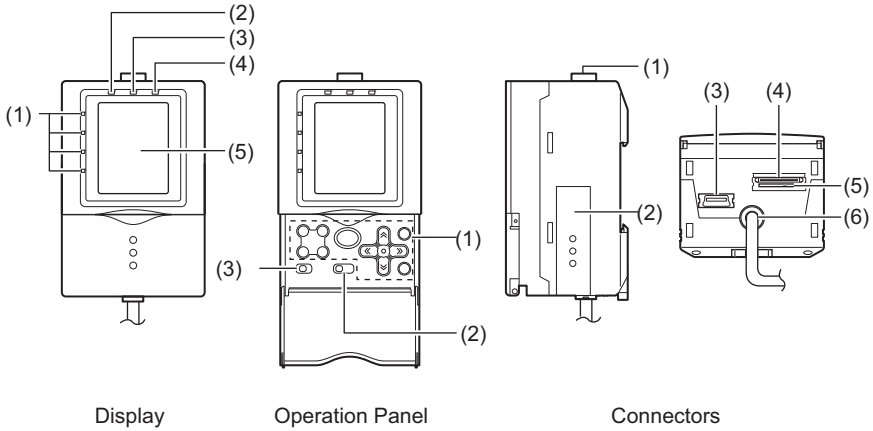

Display

Name	Function
(1) Judgment indicator	The indicator turns ON when the result of task judgment is OK, and turns OFF when a setting is not made, measurement is OFF, the result of a judgment is NG, or an error occurs.
(2) Laser indicator	The laser indicator turns ON while the Sensor Head is emitting a laser beam.
(3) Zero Reset indicator	The Zero Reset indicator turns ON when the zero reset function is enabled.
(4) Trigger indicator	The Trigger indicator turns ON when a trigger signal is input.
(5) LCD monitor	The LCD monitor displays setup menus and images captured from the Sensor Head.

Operation Panel

Name	Function
(1) Control keys	<p>These keys are used for setting measurement conditions or switching the display.</p> <p> List of Key Operations p.218</p>
(2) Mode switch	<p>This switch selects the operation mode.</p> <p>FUN : Select this mode when setting measurement conditions.</p> <p>ADJ : Select this mode when adjusting the judgment threshold value.</p> <p>RUN : Select this mode when performing measurement.</p> <p>Measurement results and judgment results are output only when the RUN mode is currently selected.</p>
(3) Menu switch	<p>This switch selects the setup menu.</p> <p>STD : Standard menu. Select this when setting the minimum required items for measurement.</p> <p>EXP : Expert menu. Select this when making a more detailed setup.</p>

Connectors

Name	Function
(1) Sensor Head connector	This connector connects the Sensor Head.
(2) Function extension connector	Insert this connector into the Controller Link Unit when gang-mounting Data Storage Units and Controllers. Slide the cover (supplied) downwards to open.
(3) USB port	Connect the USB cable (MINI-B) to the USB port to connect to a personal computer.
(4) RS-232C connector	<p>Connect the RS-232C cable (exclusive product) when you are connecting the Controller to a PLC, programmable terminal or personal computer.</p> <p> RS-232C cable p.17</p>
(5) Voltage/Current switch	<p>This switch is for selecting voltage output or current output as the analog output.</p> <p>(default value: voltage output)</p> <p>Important</p> <p>Before operating this switch, make sure that the Controller is turned OFF.</p>
(6) I/O cable	The I/O cable connects the Controller to the power supply and external devices, such as timing sensors or programmable controllers.

Basic Knowledge for Operation

The ZG2 series is a non-destructive type sensor that measures cross-section shapes by emitting a wide band of laser light onto the object and capturing light reflected from the object by a CCD. This CCD imaging information is used to generate a profile of the object's shape, and dimensional shapes, such as height, steps, width, position, points of intersection, inclination, and cross-sectional area, can be measured instantaneously from the cross-section shape of the object.

Profile Screen

A cross-section shape of the measurement object displayed on screen is called a "profile." Profiles are displayed on screen as a yellow line.

In the RUN/ADJ modes, the measurement state can be visually checked by these profiles. Also, in the FUN mode, profiles can be used to set the measurement conditions. Height measurement items are already set as the default, so it is possible to know immediately the detection status of the Sensor Head by setting the operation mode to the RUN mode.

On the ZG2 series, measurement points in the height and width directions are measured on the vertical (Z-axis) and horizontal (X-axis) axes, respectively. Measurement values are displayed as numerical values prefixed with a + (plus) or - (minus) sign depending on the coordinate position.

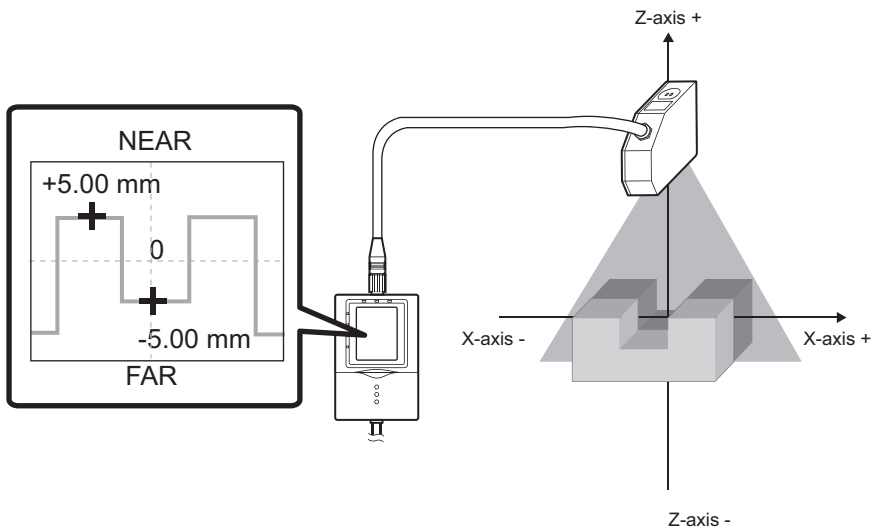

Precautions when designing a production line

The following describes details to be aware of before installing the ZG2 on a production line.

Measurement Range in Height Direction and Resolution

The ZG2 incorporates the CCD mode function that alters how the CCD is used to achieve high-speed and high-resolution measurement.

When the CCD mode is changed, the measurement range in the height direction and the resolution are altered.

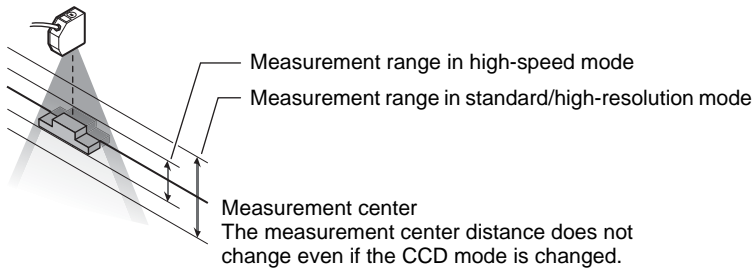

For actual details of measurement ranges, refer to the respective pages that explain mounting of each of the sensor heads.

 Mounting the Sensor Head p.27

Three CCD Modes and Their Characteristics

Resolution in the height direction changes as follows according to the CCD mode.

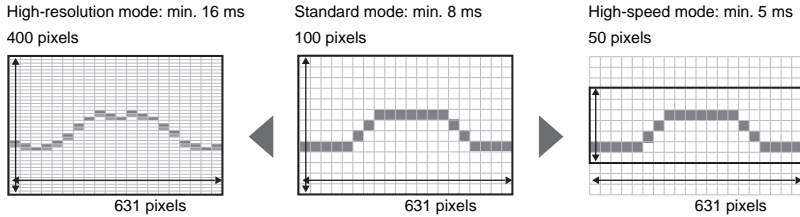

By quadrupling the number of pixels in the height direction

By decreasing the number of pixels into 1/2 in the height direction

High-resolution measurement of the shape of measurement targets

Shape measurement in fast line speed processes

Setting the CCD Mode p.121

The resolution in the horizontal direction does not change. When measuring edge position or width, select the CCD mode based on the response time as the resolution will not change whichever mode is selected.

Note **Number of pixels and resolution**

To express the clarity on a digital camera or image scanner, the term “resolution” is used. The same approach is used on the ZG2 series, too. A “high resolution” expresses a sharp image, while a “low resolution” expresses a grainy image. Resolution is determined by the number of pixels per unit area. Though a sharper or higher resolution image is obtained, the more pixels there are per unit area, processing takes that much longer proportionate to the amount of information for that image.

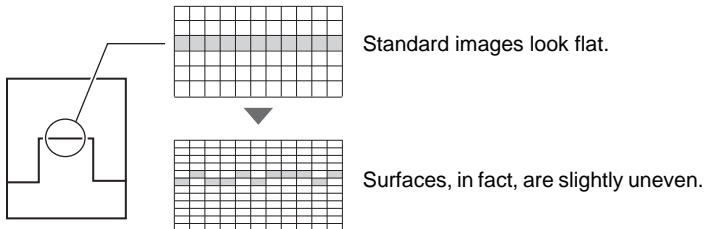

Trigger Measurement/Continuous Measurement

The ZG2 series is provided with two measurement modes, “input of an external trigger to start measurement” and “continuous measurement without the need for input of a trigger.” Note, however, that available sensitivities are restricted by the type of trigger and direction in which the measurement object is moving. Select which combination to use to suit your specific application.

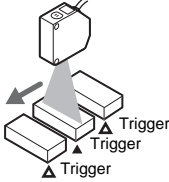
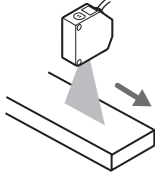
Measurement trigger and direction in which object is flowing		Appropriate sensitivity
Measurement by external trigger 	When object can be made stationary	High-speed MULTI sensitivity/MULTI sensitivity
	When object cannot be made stationary	AUTO sensitivity/FIXED sensitivity
Continuous measurement 		AUTO sensitivity/FIXED sensitivity

Note

The default setting is continuous measurement.

To perform measurement by an external trigger, the setting must be changed.



Setting for Measurement by the TRIG Signal p.136

What is “Sensitivity Adjustment?”

It is relatively easy to measure the shape of a measurement target that receives a sufficient and uniform amount of light. However, in the case of measurement targets having a complex shape, inclined surfaces cause reflected light to decrease and areas of insufficient received light to occur. There are also cases where the amount of received light is insufficient or, alternatively, saturated caused by the color or material of the measurement target. In this way, the sensitivity of the Sensor must be adjusted so that shapes are accurately captured even if the shape, color, material, etc. of the measurement target is influenced.

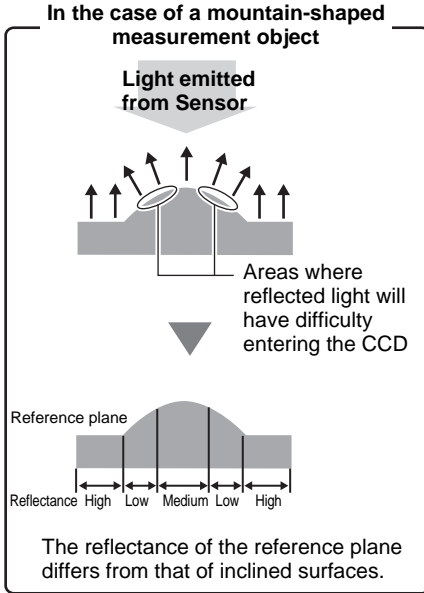

Areas having low reflectance cannot be measured due to insufficient light amount.

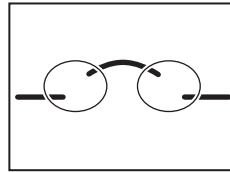

▼ Sensitivity adjustment

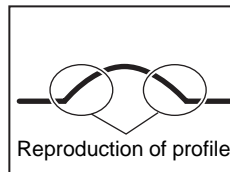

Sensitivity Adjustment Functions of the ZG2 Series

The ZG2 series is provided with three sensitivity adjustment functions.

 Adjusting Sensitivity p.96

High-speed MULTI sensitivity/MULTI sensitivity

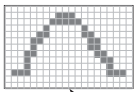

The optimum sensitivity is adjusted for individual lines and combined to form the image.

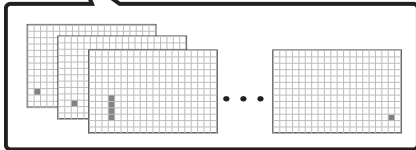

The amount of received light per individual line is judged and the appropriate sensitivity for each individual line is adjusted to accommodate for all kinds of shape, color and material. The measurement target must be made stationary as time is required to capture multiple image frames while changing the sensitivity.

High-speed MULTI sensitivity is used when MULTI sensitivity is required on lines having a fast tact time. The upper/lower limit range at which sensitivity is switched and the capture count can be restricted. The optimum sensitivity and number of image frames are set automatically within this range. Note, however, that the measurement must first be made stationary even in the high-speed MULTI sensitivity mode.

AUTO sensitivity

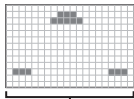

The optimum sensitivity common to all lines is adjusted.

The amount of received light for all lines is judged to adjust to the appropriate sensitivity for the entire area. As sensitivity is batch-adjusted for all lines, the response is not as slow as that for MULTI sensitivity, so this mode is a generally applicable mode.

FIXED sensitivity

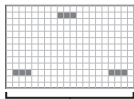

Sensitivity is fixed for all lines.

In this mode, a predetermined sensitivity is used. As sensitivity is not adjusted during measurement, response is fast, making it ideal for when a trigger is input at short intervals to perform measurement.

Mounting and Connecting Devices

Mounting the Sensor Head

⚠ WARNING

Never look into the laser beam. Doing so continuously will result in visual impairment.
Never look into the laser beam.



Do not attempt to dismantle, pressurize, or incinerate the product. Doing so may cause the laser beam to leak, resulting in the danger of visual impairment. Do not attempt to dismantle, pressurize, or incinerate the product.



Installations to Suit Measurement Target and Environment

Pay attention to the following points when mounting the Sensor Head to prevent measurement precision from dropping.

Color/shiny surface boundary

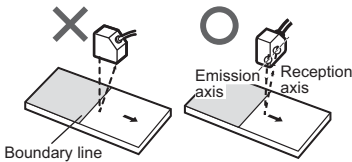

Mounting near walls

Measurement errors can be reduced by installing the Sensor Head with the line formed by the emission and reception axes parallel to the wall, and painting the wall with non-reflective black paint.

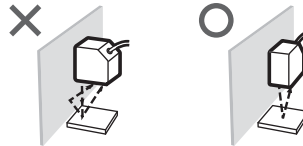

Narrow grooves or indentations

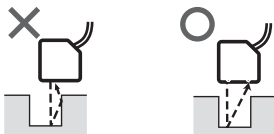

Rotating objects

You can minimize the influence caused by vibration of the rotating object and positional shifts by installing the Sensor Head with the line formed by the emission and reception axes parallel to the axis of rotation.



Measuring stepped objects



Effect of peripheral lighting

Do not install the Sensor Head in a place where strong light hits the laser emitter/receiver section of the Sensor. Also, if a measurement target has a shiny surface, the light from the lighting will be reflected and a malfunction may occur. In such as case, prevent reflection, for example, by covering the light to stop reflection.

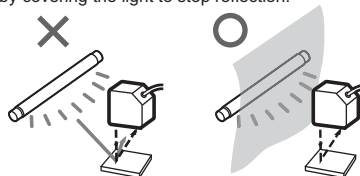

Mounting the ZG2-WDS70

Fix by mounting screws making sure that the distance between the Sensor Head and measurement target is matched.

Mounting method

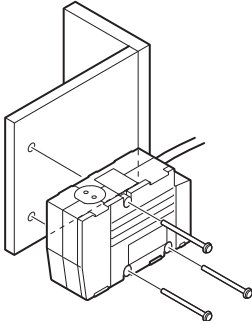

Fasten the Sensor Head onto the mounting base with M4 screws.

Tightening torque: 1.2 N-m

Important

For details on the positions of screw holes, check the external dimensions in "APPENDICES."

 External dimensions p.196

Mounting position

Mount the Sensor Head according to the following distances and angle.

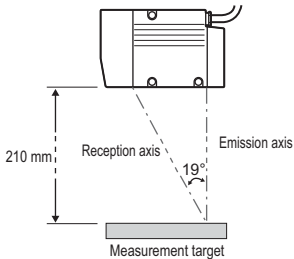

Mounting for diffuse reflection measurement

Measurement range

Numerical values in the figure are for when the standard CCD mode is set. When the CCD mode is changed, check the values in the table below.

<Mounting for diffuse reflection measurement>

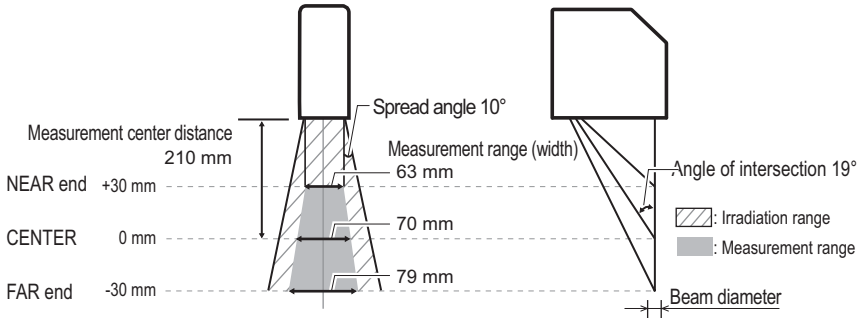

CCD Mode	Measurement center distance	Measurement range (height)	Measurement range (width)	Beam diameter
Standard mode	210mm	±30 mm	NEAR end: 63mm	300 μm
			CENTER: 70mm	120 μm
			FAR end: 79mm	300 μm
High-resolution mode	210mm	±48 mm	NEAR end: 57mm	410 μm
			CENTER: 70mm	120 μm
			FAR end: 83mm	410 μm
High-speed mode	210mm	±15 mm	NEAR end: 66mm	210 μm
			CENTER: 70mm	120 μm
			FAR end: 74mm	210 μm

Important

The beam diameter and measurement range (width) between the NEAR/FAR ends are nominal values, and are not to be used as guaranteed values.

Mounting the ZG2-WDS22

Fix by mounting screws making sure that the distance between the Sensor Head and measurement target is matched.

Mounting method

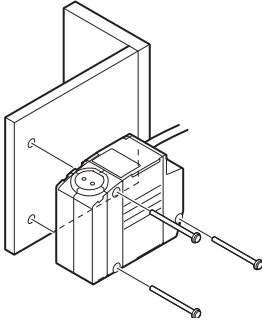

Fasten the Sensor Head onto the mounting base with M4 screws.

Tightening torque: 1.2 N-m

Important

For details on the positions of screw holes, check the external dimensions in "APPENDICES."

 External dimensions p.197

Mounting position

Mount the Sensor Head according to the following distances and angle.

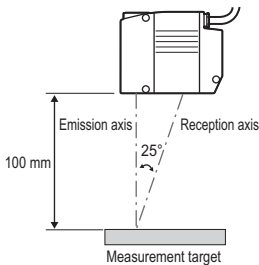

Mounting for diffuse reflection measurement

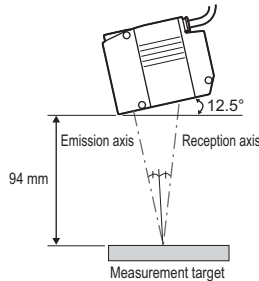

Mounting for regular reflection measurement

Note

The default mounting state of the Sensor Head is for diffuse reflection measurement. To set the Sensor Head for regular reflection measurement, change the Sensor Head mounting setting.

 Setting the Sensor Head Installation Status p.118

Measurement range

Numerical values in the figure are for when the standard CCD mode is set. When the CCD mode is changed, check the values in the table below.

<Mounting for diffuse reflection measurement>

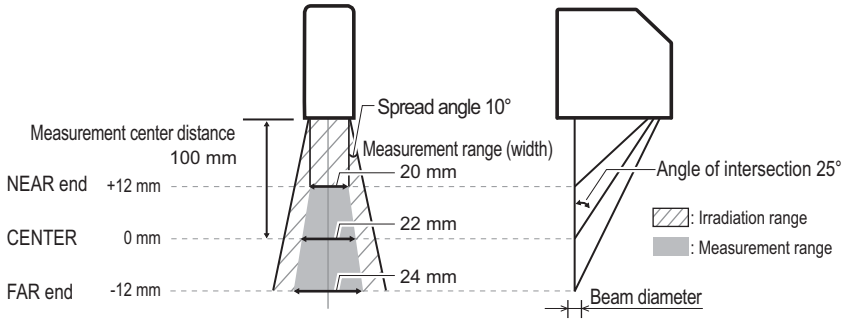

CCD Mode	Measurement center distance	Measurement range (height)	Measurement range (width)	Beam diameter
Standard mode/ high-resolution mode	100mm	±12 mm	NEAR end: 20mm	220 μm
			CENTER: 22mm	60 μm
			FAR end: 24mm	220 μm
High-speed mode		±6 mm	NEAR end: 21mm	140 μm
			CENTER: 22mm	60 μm
			FAR end: 23mm	140 μm

Important

The beam diameter and measurement range (width) between the NEAR/FAR ends are nominal values, and are not to be used as guaranteed values.

<Mounting for regular reflection measurement>

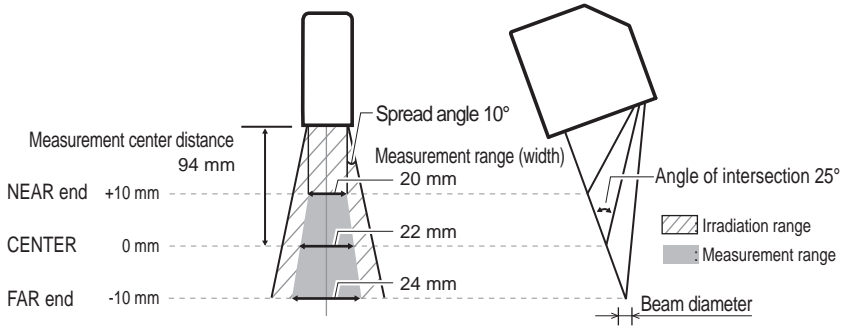

CCD Mode	Measurement center distance	Measurement range (height)	Measurement range (width)	Beam diameter
Standard mode/ high-resolution mode	94mm	±10 mm	NEAR end: 20mm	220 μm
			CENTER: 22mm	60 μm
			FAR end: 24mm	220 μm
High-speed mode		±6 mm	NEAR end: 21mm	140 μm
			CENTER: 22mm	60 μm
			FAR end: 23mm	140 μm

Important

The beam diameter and measurement range (width) between the NEAR/FAR ends are nominal values, and are not to be used as guaranteed values.

Mounting the ZG2-WDS8T

Fix by mounting screws making sure that the distance between the Sensor Head and measurement target is matched.

Mounting method

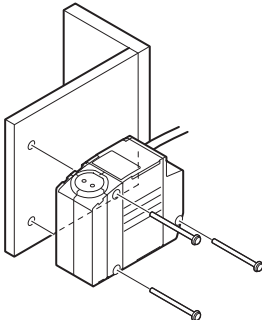

Fasten the Sensor Head onto the mounting base with M4 screws.

Tightening torque: 1.2 N-m

Important

For details on the positions of screw holes, check the external dimensions in "APPENDICES."

 External dimensions p.197

Mounting position

Mount the Sensor Head according to the following distances and angle.

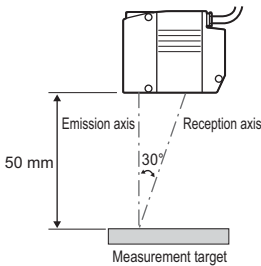

Mounting for diffuse reflection measurement

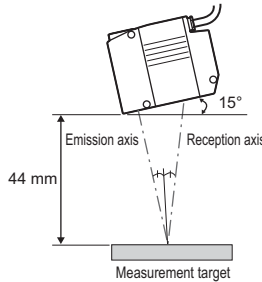

Mounting for regular reflection measurement

Note

The default mounting state of the Sensor Head is for diffuse reflection measurement. To set the Sensor Head for regular reflection measurement, change the Sensor Head mounting setting.

 Setting the Sensor Head Installation Status p.118

Measurement range

Numerical values in the figure are for when the standard CCD mode is set. When the CCD mode is changed, check the values in the table below.

<Mounting for diffuse reflection measurement>

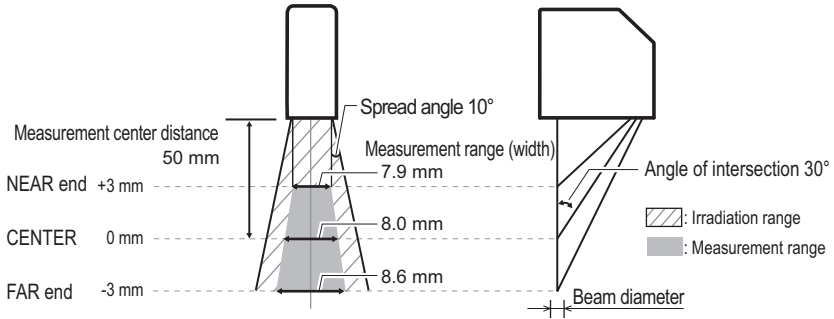

CCD Mode	Measurement center distance	Measurement range (height)	Measurement range (width)	Beam diameter
Standard mode/ high-resolution mode	50mm	±3 mm	NEAR end: 7.9mm	120 μm
			CENTER: 8.0mm	30 μm
			FAR end: 8.6mm	120 μm
High-speed mode		±1.5 mm	NEAR end: 7.7mm	110 μm
			CENTER: 8.0mm	30 μm
			FAR end: 8.3mm	110 μm

Important

The beam diameter and measurement range (width) between the NEAR/FAR ends are nominal values, and are not to be used as guaranteed values.

<Mounting for regular reflection measurement>

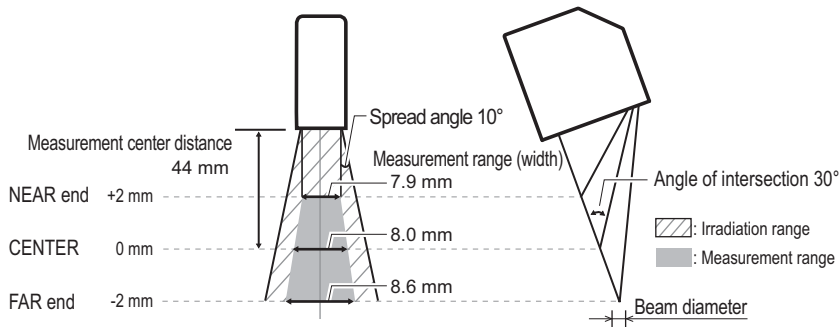

CCD Mode	Measurement center distance	Measurement range (height)	Measurement range (width)	Beam diameter
Standard mode/ high-resolution mode	44mm	±2 mm	NEAR end: 7.9mm	120 μm
			CENTER: 8.0mm	30 μm
			FAR end: 8.6mm	120 μm
High-speed mode	44mm	±1 mm	NEAR end: 7.9mm	105 μm
			CENTER: 8.0mm	30 μm
			FAR end: 8.1mm	105 μm

Important

The beam diameter and measurement range (width) between the NEAR/FAR ends are nominal values, and are not to be used as guaranteed values.

Mounting the ZG2-WDS3VT

Fix by mounting screws making sure that the distance between the Sensor Head and measurement target is matched.

Mounting method

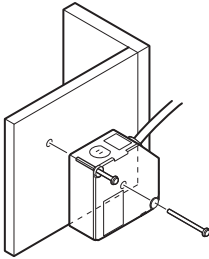

Fasten the Sensor Head onto the mounting base with M4 screws.

Tightening torque: 1.2 N·m

Important

For details on the positions of screw holes, check the external dimensions in "APPENDICES."

 External dimensions p.199

Mounting position

Mount the Sensor Head according to the following distances and angle.

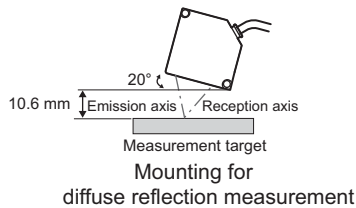
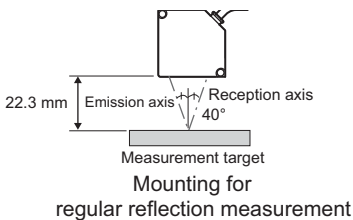

Note

The default mounting state of the Sensor Head is for regular reflection measurement. To set the Sensor Head for diffuse reflection measurement, change the Sensor Head mounting setting.

 Setting the Sensor Head Installation Status p.118

Measurement range

Numerical values in the figure are for when the standard CCD mode is set. When the CCD mode is changed, check the values in the table below.

<Mounting for regular reflection measurement>

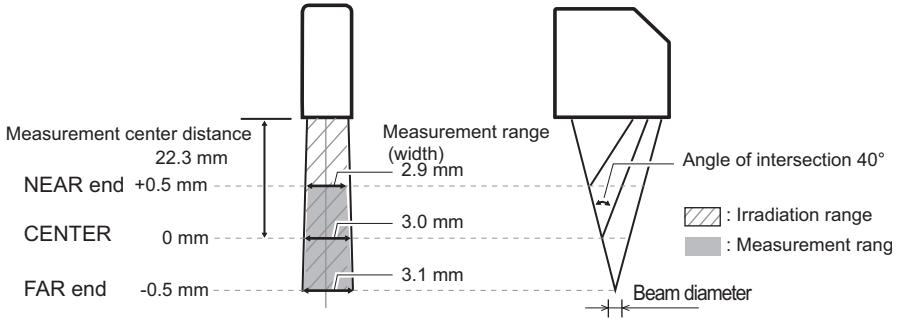

CCD Mode	Measurement center distance	Measurement range (height)	Measurement range (width)	Beam diameter
Standard mode/ high-resolution mode	22.3mm	±0.5 mm	NEAR end: 2.9mm	40 μm
			CENTER: 3.0mm	25 μm
			FAR end: 3.1mm	40 μm
High-speed mode		±0.25 mm	NEAR end: 2.95mm	33 μm
			CENTER: 3.0mm	25 μm
			FAR end: 3.05mm	33 μm

Important

The beam diameter and measurement range (width) between the NEAR/FAR ends are nominal values, and are not to be used as guaranteed values.

<Mounting for diffuse reflection measurement>

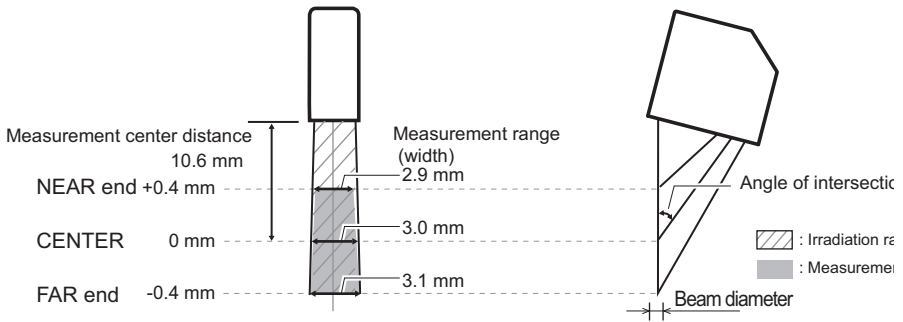

CCD Mode	Measurement center distance	Measurement range (height)	Measurement range (width)	Beam diameter
Standard mode/ high-resolution mode	10.6mm	±0.4 mm	NEAR end: 2.9mm	40 μm
			CENTER: 3.0mm	25 μm
			FAR end: 3.1mm	40 μm
High-speed mode		±0.2 mm	NEAR end: 2.95mm	33 μm
			CENTER: 3.0mm	25 μm
			FAR end: 3.05mm	33 μm

Important

The beam diameter and measurement range (width) between the NEAR/FAR ends are nominal values, and are not to be used as guaranteed values.

Mounting the Controller

Cautions Regarding the Mounting Orientation

To improve heat radiation, install the Controller only in the orientation shown below.

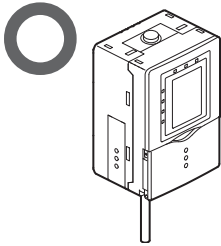

Do not install the Controller in the following orientations:

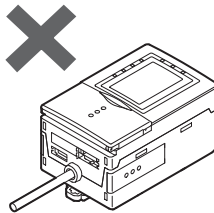
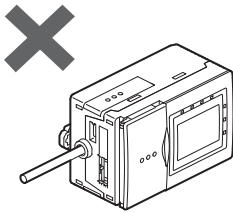

Important

- Do not block the ventilation holes at the top and bottom of the Controller body. Doing so will cause heat to build up inside and result in a malfunction.
- When the temperature inside the control panel exceeds the ambient temperature of 50°C, provide forced-air cooling or more space at surrounding areas, or improve air circulation to lower the ambient temperature to 50°C or less.

Mounting on a DIN Track

Mount Controllers on a DIN track correctly according to the number of Controllers to be used.

When using only one Controller

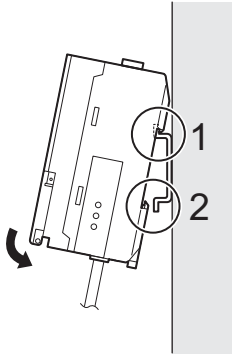

- 1** Hook the connector end of the Controller onto the DIN track.
- 2** Push the Controller down onto the DIN track until the hook on the I/O cable side is locked.

Important

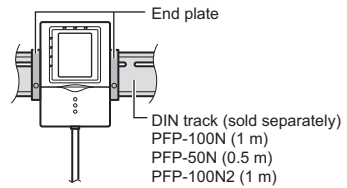

After mounting the Controller on the DIN track, attach the end plates on both sides of the Controller.

When gang-mounting devices

The following explains how to mount Controllers when using a Data Storage Unit as well or when gang-mounting two Controllers on the DIN track.

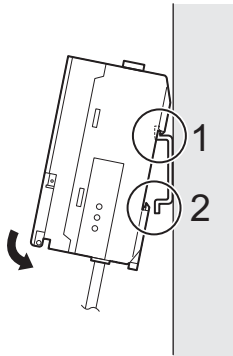

- 1 Hook the connector end of the Controller onto the DIN track.
- 2 Push the Controller down onto the DIN track until the hook on the I/O cable side is locked.

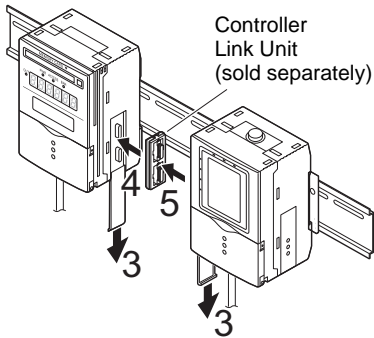

- 3 Open the gang-mount cover. Slide the cover downwards to remove.
- 4 Insert the Controller Link Unit into the connector on the unit on the left side.

Important

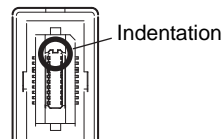

The connector must be inserted at the correct orientation. Insert so that the indentation on the Controller Link Unit in the figure above matches the connector protrusion on the unit on the left side.

- 5** Slide the Controller on the right side towards the Controller Link Unit so that it fits into the Controller Link Unit.

Note

The mounting method is the same even when two Controllers are gang-mounted onto the Data Storage Unit. Mount in the following order: Data Storage Unit → 1st Controller → 2nd Controller.

Important

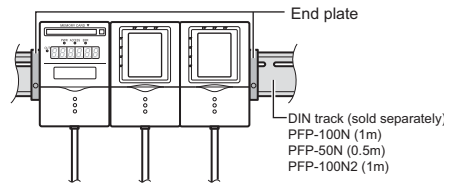

Attach the end plates on both sides of the Controller.

Removing the Controller from the DIN track (when using only one Controller)

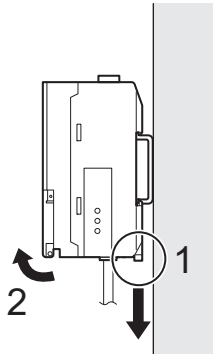

- 1** Pull the hook on the I/O cable end of the Controller downwards.
- 2** Lift up the Controller from the I/O cable end, and remove it from the DIN track.

Removing Controllers from the DIN track (when gang-mounting devices)

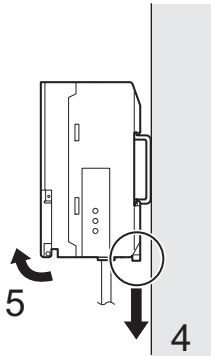
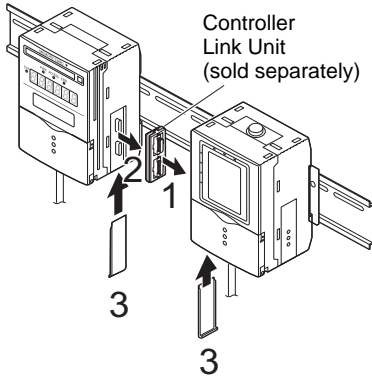

- 1** Slide the Controller so that it is removed from the connector on the Controller Link Unit.
- 2** Remove the Controller Link Unit from the connector on the Data Storage Unit.
- 3** Attach the covers to the Data Storage Unit and Controller gang-mount.
- 4** Pull the hook on the I/O cable end of the Controller downwards.
- 5** Lift up the Controller from the I/O cable end, and remove it from the DIN track.

Note

The removal method is the same even when two Controllers are gang-mounted onto the Data Storage Unit. Remove in the following order: 2nd Controller → 1st Controller → Data Storage Unit.

Mounting on a Panel

Mount Controllers on a panel correctly according to the number of Controllers to be used.

When using only one Controller

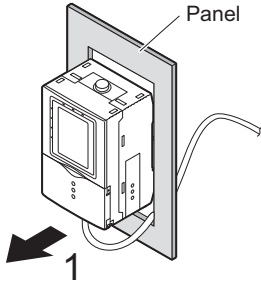

- 1** Push out the Controller from the rear of the panel towards the front.

 When mounting on a panel
p.206

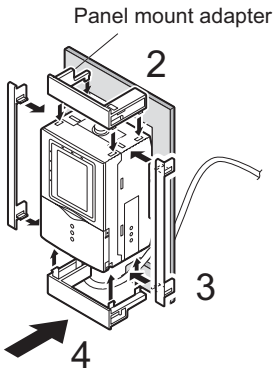

- 2** Install the short Panel Mount Adapters on the four holes on the Controller.

- 3** Install the long Panel Mount Adapters on the two holes on the Controller.

- 4** Install the Controller with Mount Adapters attached onto the panel from the front.

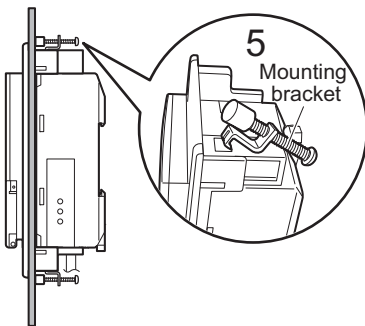

- 5** Hook the hooks of the mounting fixture onto the two holes of the short Mount Adapters and tighten the screws.

- 6** Make sure that the Controller is firmly fixed on the panel.

1 Mount the Data Storage Unit and Controllers onto the DIN track.

 When gang-mounting devices p.41

Important

When mounting devices on a panel, too, be sure to install the DIN track on the rear side of the devices.

2 Push out the Data Storage Unit and Controllers from the rear of the panel towards the front.

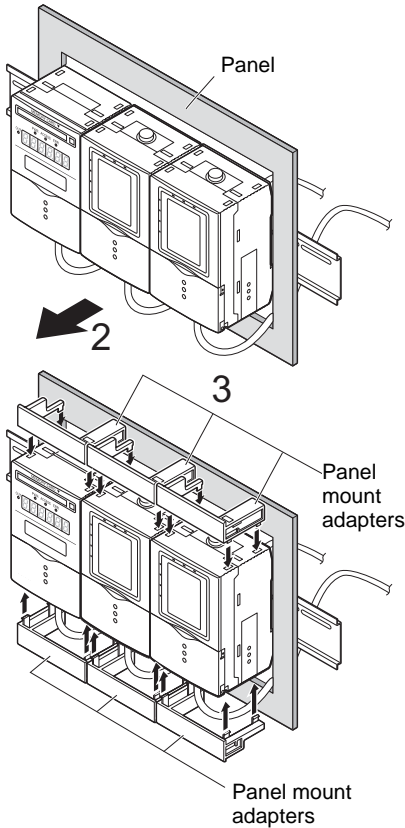

3 Install the short Panel Mount Adapters on the four holes on the Data Storage Unit and Controllers.

Important

Install the short Panel Mount Adapters on the gang-mounted Data Storage Unit and all Controllers.

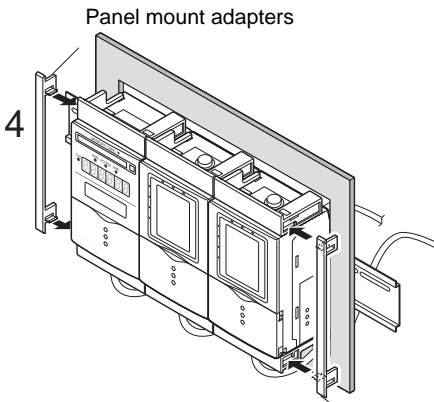

4 Install the long Panel Mount Adapters on the two holes on the short Panel Mount Adapter.

Important

Attach the long Panel Mount Adapters on only both sides of the gang-mounted Data Storage Unit and Controllers.

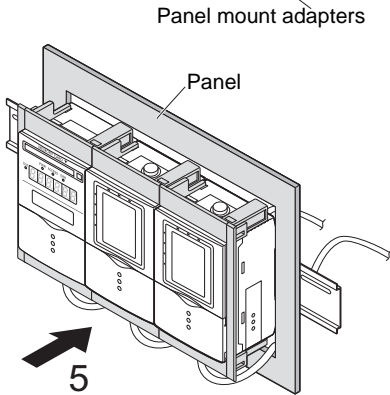

5 Install the Data Storage Unit and Controllers with Mount Adapters attached onto the panel from the front.

Important

Take care not to nip the I/O cable.

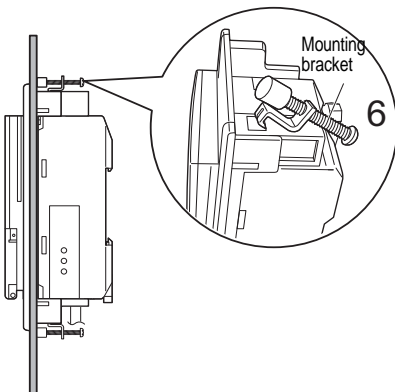

6 Hook the hooks of the mounting fixtures onto the two holes of the short Mount Adapters and tighten the screws.

Important

Attach fixtures at two locations of each of the gang-mounted Data Storage Unit and all Controllers.

7 Make sure that the Data Storage Unit and Controllers are firmly fixed on the panel.

Combinations of Gang-mounted Controllers

With the ZG2 series, one Data Storage Unit (ZG2-DSU) and up to two Controllers (ZG2-WDC) can be gang-mounted. For details on the Data Storage Unit (ZG2-DSU), refer to the ZG2-DSU User's Manual.

Important

- Supply power to all of the gang-mounted Controllers.
- The following three gang-mount combinations and arrangements are allowed. Note that other combinations and arrangements will not result in proper operation.

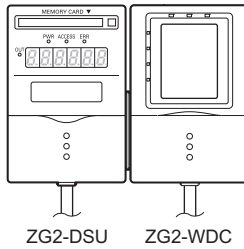
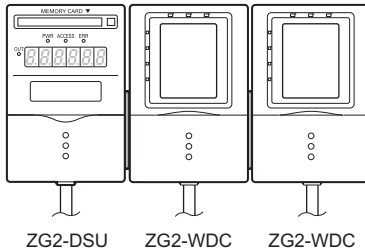
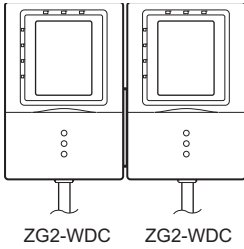

CH number when Controllers are gang-mounted

CH numbers are automatically assigned as follows when Controllers are gang-mounted. To collect data from a Controller using the Data Storage Unit (ZG2-DSU_1), select the CH number of the targeted Controller.

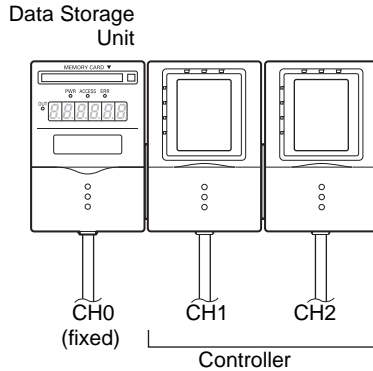

Important

- In the gang-mounted arrangement, the Data Storage Unit must be located at the leftmost end viewed from the front.
- Even when the Data Storage Unit is not gang-mounted, the CH numbers of the Controllers are CH1 and CH2 in this order from the left.

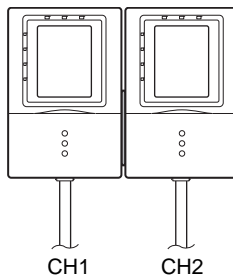

Connecting Devices

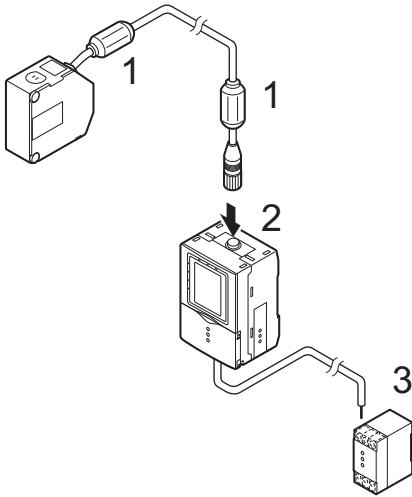

Important

Before connecting/disconnecting the Sensor Head, make sure that the Controller is turned OFF. The Controller may break down if the Sensor Head is connected or disconnected while the power is ON.

- 1 Attach the ferrite cores (supplied) to both ends of the Sensor cable.**
- 2 Insert the Sensor Head connector into the Controller until it locks in place.**
- 3 Connect the Controller's I/O cable and power supply.**

Important

If the Controller is turned ON without the Sensor Head connected, the Controller's screen will remain dark and messages cannot be read. Before turning the Controller ON, connect the Sensor Head.

Attaching the Ferrite Cores

Attach the ferrite cores (supplied) to both ends of the Sensor Head cable and to the Controller's I/O cable.

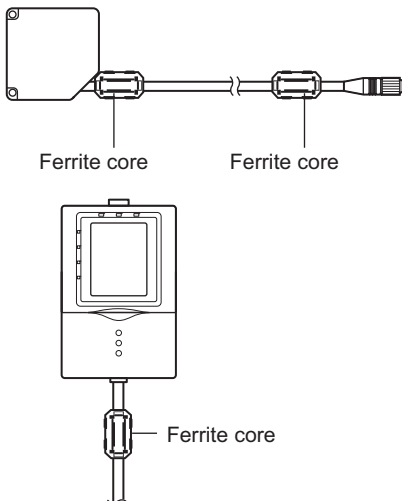

Connecting Cables

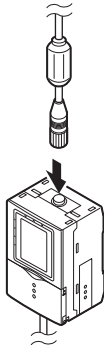

- 1** Insert the Sensor Head's connector straight into the Sensor Head connector on the Controller.

Make sure that you hear the connector snap firmly into place when it is connected.

- 2** Fasten firmly with the fastening screws (two screws, one each on the left and right).

Important

- Do not touch the terminals inside the connector.
- All settings on the Controller will be cleared if the Sensor Head is replaced with a different type.
- Fasten the connector while making sure that it is not subjected to vibration or shock.
- Do not mount the Controller in such a way that a load is steadily applied on the connector, for example, with tension applied to the cables.

- O** When wiring, do not bend the cable for at least 10 mm from the edge of the connector.

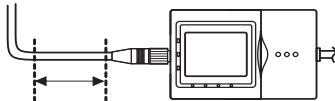

At least 10 mm

- X** If the cable is bent in the first 10 mm away from the edge of the connector, stress may adversely affect measurements.

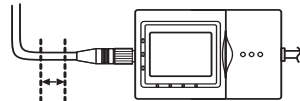

10 mm or less

<Removing the cable>

Loosen the fastening screws (two locations) to unlock the cable, and then draw out the connector straight from the Sensor side.

Note To extend the connection between the Sensor Head and the Controller

The cable connection between the Sensor Head and the Controller can be extended by using the extension cable (sold separately). Attach the ferrite cores (supplied) to both ends of the extension cable.

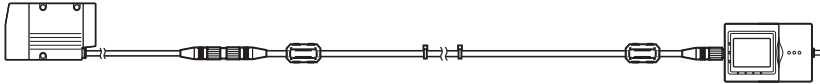

Cable for Sensor
(flexible cable): 0.5 m, 2 m

Extension cable
(Flexible cable)
ZG2-XC3CR: 3 m
ZG2-XC8CR: 8 m
ZG2-XC15CR: 15 m
ZG2-XC25CR: 25 m

Connecting the Power Supply

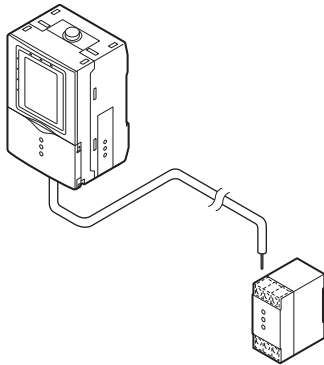

1 Connect the power wire (brown) and GND wire (blue) of the Controller's I/O cable to the 24 VDC ($\pm 10\%$) power supply.

Note

The following power supply is recommended:

- S8VS-03024 (24V DC, 1.3 A)

Be sure to connect the Controller to the power supply in a 1:1 connection.

Important

After turning the power supply ON, allow the product to stand for at least 30 minutes before use. The circuits are still unstable just after the power supply is turned ON, so measurement values may fluctuate gradually.

Overview of Settings and Measurement

Operation Modes

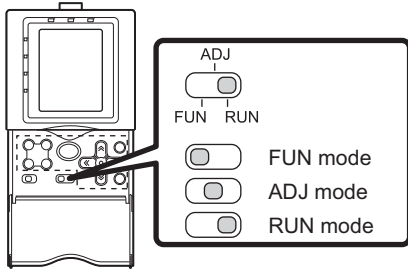

The ZG2-WDC□□ has the following three operation modes. Switch to the desired mode before you start operation.

To switch the operation mode, use the mode switch.

Mode	Description	
FUN mode	This mode is for setting the measurement conditions. The easy-to-follow icon-based display allows operations to be performed intuitively.	<p>Top Screen</p> <p>The screenshot shows a screen with the word 'FUN' at the top and 'MEAS' at the bottom. In the center, there are four circular icons: a home icon, a back icon, a refresh icon, and a measurement icon.</p>
ADJ mode	This mode is for checking the measurement state, and setting threshold values and output conditions.	<p>Top Screen</p> <p>The screenshot shows a screen with 'HEIGHT1' and 'B01T1' at the top. Below is a diagram of a measurement on a stepped surface. At the bottom, the text reads '109.052 10 mm' and 'LV: 1-320'.</p>
RUN mode	This mode is used for performing actual measurement. The measurement information is displayed on the LCD screen.	<p>Top Screen</p> <p>The screenshot shows a screen with 'HEIGHT1' and 'B01T1' at the top. Below is a diagram of a measurement on a stepped surface. At the bottom, the text reads '109.052 10 mm' and 'LV: 1-320'.</p>

Tasks and Bank Data

Multi-task Measurement

On the ZG2 series, up to eight measurements for a single profile can be processed simultaneously. This function is called “multi-task measurement.”

Example:

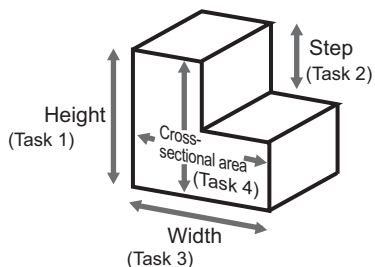

Measurement is performed with “height,” “width,” “step” and “cross-sectional area” set to tasks 1 to 4, respectively. In other words, this means that the total of tasks 1 to 4 allow you to judge the shape.

Data for Change of Device Setup

If you register bank data for each individual model, you can reduce the time required for changing the device setup as all you need to do is to select different bank data to change the measurement conditions.

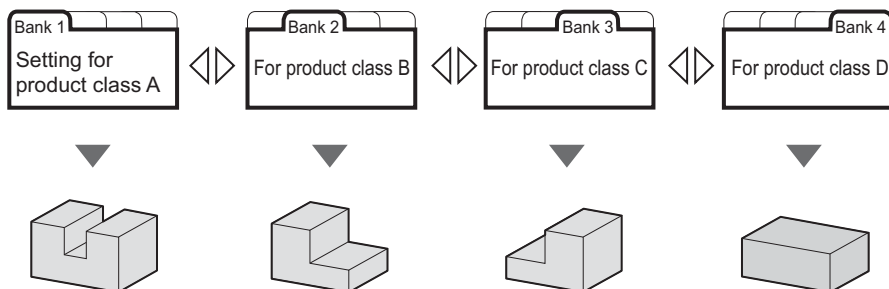

Relationship between Tasks and Bank Data

You can register up to eight tasks to a single set of bank data. Up to 16 sets of bank data can be set and saved on the ZG2 series, so you can prepare up to 128 measurement patterns by combining bank data with task settings. Combinations of bank data and tasks become the measurement and judgment condition settings.

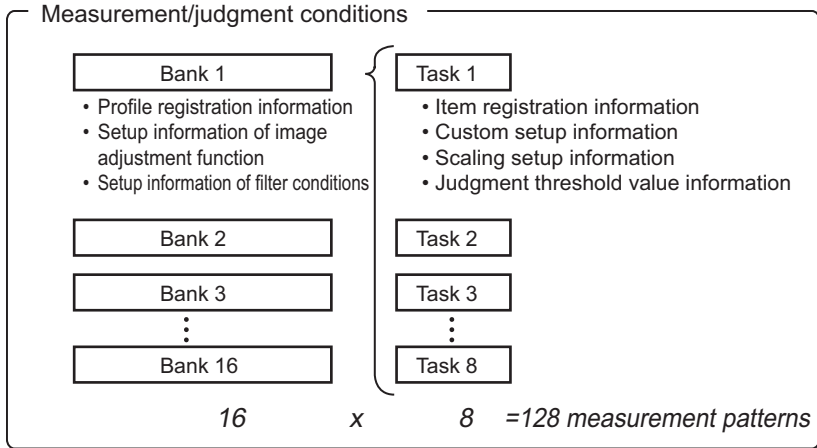

Note Number of banks

The maximum number of banks that can be saved on a Controller is 16. This can be expanded up to 4096 banks (16 banks × 256 files) by gang-mounting the Data Storage Unit (ZG2-DSU).

For details, refer to the ZG2-DSU User's Manual.

STD Menu and EXP Menu

The Controller has two setup modes, the “STD menu” and the “EXP menu.” The features of each of these menus are as follows.

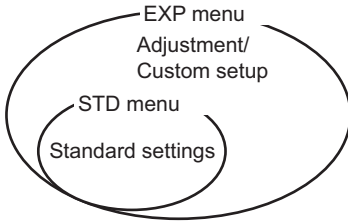

<STD menu>

This menu is designed for ease of operation, so its setting and adjustment ranges are limited. Setting in this mode comprises only three steps, so you can start measurement immediately.

<EXP menu>

This menu allows you to set all adjustment functions. You can use this menu to execute advanced measurement processing, such as measurement of image angle, calculation of processing items and selection of characteristic points.

Switching the menu

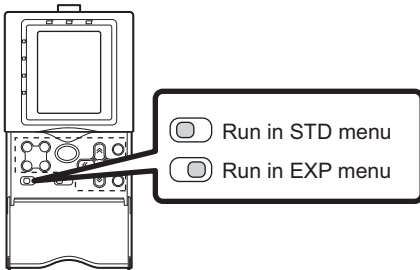

The STD and EXP menus are switched by the menu switch on the front of the Controller. The two menus cannot be selected simultaneously during menu operation as the menu is fixed by the menu switch.

Initializing Controller Settings

Important

The settings of all banks and system settings are initialized regardless of the currently selected bank No. To save the settings, back them up to a personal computer before performing initialization.

- Receive System Data <SYSSAVE command> p.171
- Receive Bank Data <BANKSAVE command> p.169

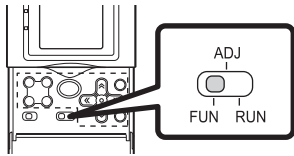

- 1 Switch to the FUN mode.**
The top screen is displayed.

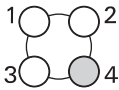

- 2 Select [System].**

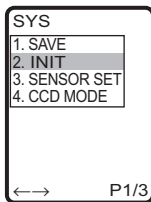
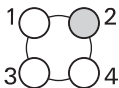

- 3 Select [INIT].**

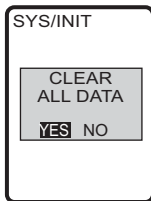
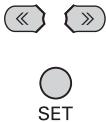

- 4 Move to [YES] and press the SET key.**

BASIC OPERATIONS

Flow of Basic Setup	58
Starting Measurement	66

Flow of Basic Setup

The following describes the flow of basic setup using, as an example, "2-pt step".

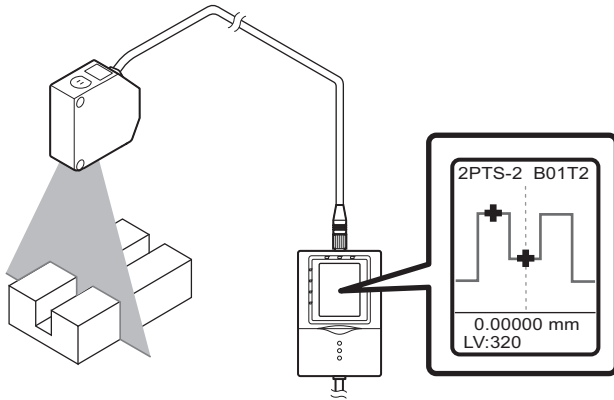

step 1 **Displaying the reference target object**
Display the target profile on the Controller's LCD monitor.

 p.59

step 2 **Stabilizing the shape profile (APS function)**

Use the APS function to perform auto-tuning to obtain the optimum settings to match the surface shape (e.g. color, shape and material) of the measurement object.

 p.60

step 3 **Registering the profile of the reference target**

Use this profile to set the measurement conditions.

 p.61

step 4 **Selecting measurement items**

Select from height, step, width, and other items to suit your particular measurement requirements.

 p.62

step 5 **Setting the measurement area**

The optimum region can be automatically set by simply enclosing the desired measurement area. This area can be fine-adjusted later on.

 p.63

step 6 **Adjusting the judgment threshold value**

Perform a test measurement and determine the threshold values.

 p.64

step 1 Displaying the reference target object

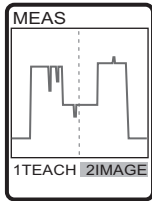
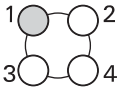
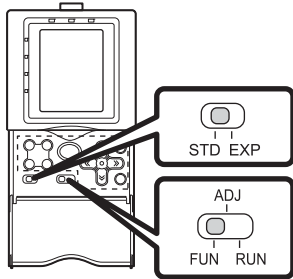

- 1** Switch to the **STD** menu.
- 2** Switch to the **FUN** mode.
The top screen of the **FUN** mode is displayed.
- 3** Select **[MEAS]**.
- 4** Set the measurement object in place.
The profile is displayed.

Note **Sensor Head mounting conditions**

If necessary, change the Sensor Head installing settings (for diffuse reflection measurement or for regular reflection measurement), or change the receiving status of the Sensor Head CCD before setting the measurement conditions.

-  Setting the Sensor Head Installation Status p.118
- Setting the CCD Mode p.121

step 2

Stabilizing the shape profile (APS function)

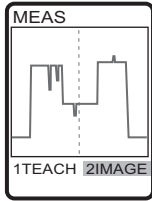

- 1** Display the screen on the left and press the **MENU/VIEW** key.
The confirmation message is displayed.

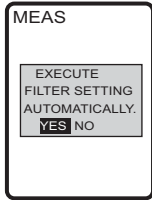

- 2** Move to **[YES]** and press the **SET** key.

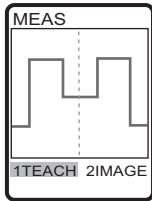

The optimum profile acquisition conditions are automatically set.

Note

When profiles are not displayed as intended



Troubleshooting p.213

step 3

Registering the profile of the reference target

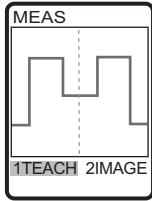
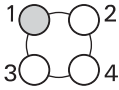

1 Select [TEACH].

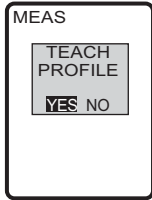
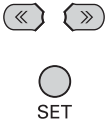

2 Move to [YES] and press the SET key.

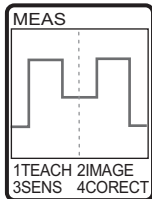

This registers the profile. Set the measurement position and edge level while viewing the registered profile. The registered profile is held in memory until teaching is performed again.

step 4 Selecting measurement items

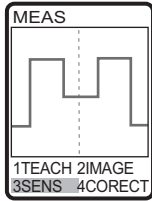
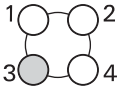

1 Select [SENS].

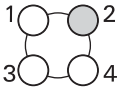

2 Select [TASK2].

Important

The default setting for [TASK1] is [HEIGHT1]. To change [TASK1] to another measurement item, select [TASK1] and change to the desired measurement item. When a measurement item is changed, the message "CHANGE ITEM" is displayed. Move to [YES], and press the SET key.

 How to Select Measurement Items p.70

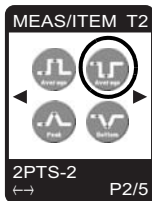
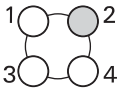

3 Select [2PTS-2] from the measurement items.

Scroll pages by the ← LEFT/ → RIGHT key, and select the measurement item.

Note To measure multiple items

Simultaneous measurement of up to eight items can be performed. To do this, repeat steps 2 and 3.

step 5 Setting the measurement area

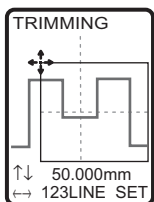
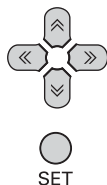

1 Adjust the top left of the desired measurement area, and press the SET key.

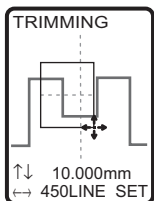
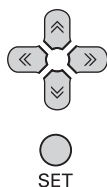

2 Adjust the bottom right of the desired measurement area, and press the SET key.

Important

Adjust the area so that the center line overlaps the vicinity of the area of the vertical line so as to enclose the two steps to be measured.

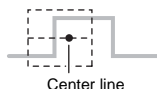

Area for point 1 Area for point 2

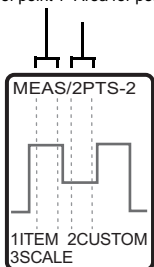

When the desired measurement area is enclosed, the region in which measurement points are extracted is automatically set.

Note

- If the target area is not displayed by automatic setting, select [CUSTOM], and adjust the area for each individual measurement point.
- To narrow the area in the vertical direction, adjust by the sensitivity adjustment area.

p.99

step 6 Adjusting the judgment threshold value

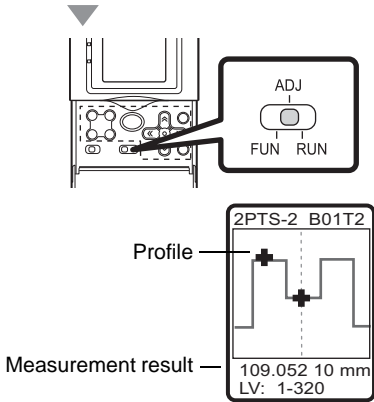

1 Switch to the ADJ mode.

The profile is continuously measured.
Perform test measurement while altering the measurement target.

Note

To switch the task display, use the ↑ UP key/↓ DOWN key.



2 Press the MENU/VIEW key.

The condition setup monitor screen is displayed.

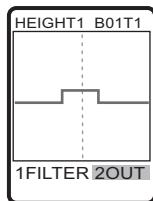

3 Select [OUT].

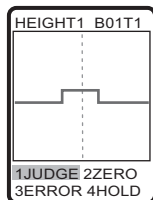

4 Select [JUDGE].

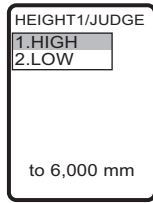
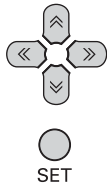

5 Set the HIGH and LOW thresholds.

Note

To change numerical values, use the ↑ UP key/↓ DOWN key, and to change the number of digits use the ← LEFT key/→ RIGHT key.

Important

The default judgment threshold value is the "rated measurement range of the currently connected Sensor Head \div 4".

Example: As the measurement range of the ZG2-WDS70 (diffuse reflection type) is "60 mm" (± 30 mm), the default judgment threshold value becomes "60 \div 4=15". So, the default threshold judgment value is ± 15 mm.

Starting Measurement

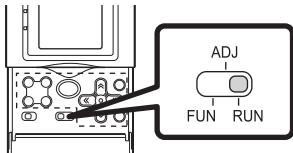

- 1 Switch to the [RUN] mode.
Measurement will start.

Monitoring the Measurement Status

The measurement information is displayed on the LCD screen. You can switch the screen to display different measurement information according to your specific application.

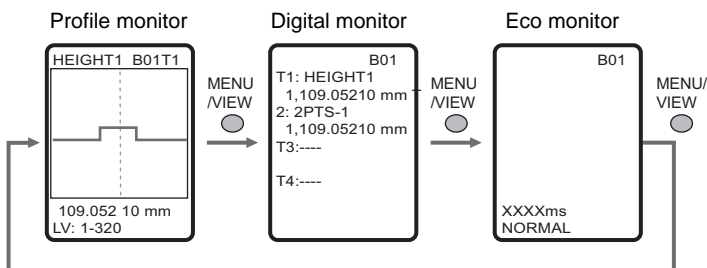

Profile monitor

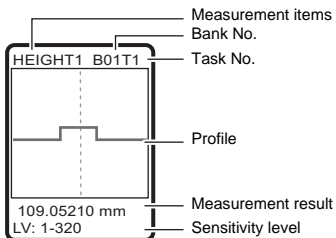

The currently measured profile is displayed. When multiple tasks are registered, switch the profile and display it for each individual task.

Note

To switch the task display, use the ↑ UP key/
↓ DOWN key.

Digital monitor

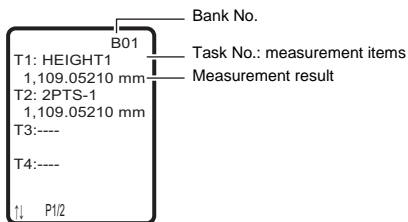

Measurement results for each individual task are displayed as a list as numerical values.

Note

To switch between the tasks 1 to 4 and tasks 5 to 8 displays, use the ↑ UP key/↓ DOWN key.

Eco monitor

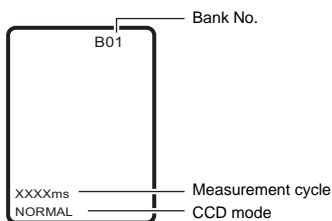

The measurement cycle and CCD mode are displayed.

Magnifying the Profile Display

A specified area of the profile display can be magnified.

▶ RUN mode-F4 key-[MGNIFY]

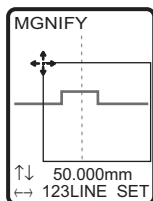

When the desired region of the profile is enclosed, it is displayed magnified.

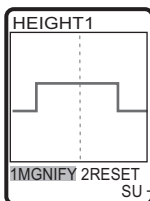

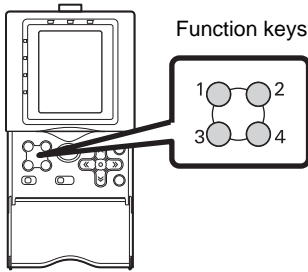

While the profile display is magnified, "SU" is displayed at the bottom right of the screen.

Function Keys

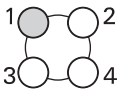
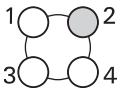
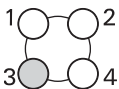
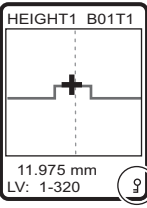
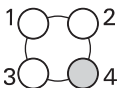

In the RUN mode, the following functions are assigned to function keys F1 to F4.









Function keys	Function
F1 	If the F1 key is pressed when [I/O]-[I/O LINE]-[TRIGGER]-[ENABLE] is set, the trigger is input.
F2 	The image is displayed. To return the display to the normal display, press the F2 key again. Measurement is stopped while the image is displayed.
F3 	 <p>When the F3 key is pressed and held down for 3 seconds or longer, the key lock confirmation message is displayed. When the key lock function is ON, the FUN/ADJ/RUN modes cannot be switched. To cancel the key lock, press and hold down the</p> <p>F3 key for 3 seconds or longer.</p>
F4 	Magnifies the profile display.  Magnifying the Profile Display p.67



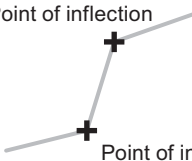

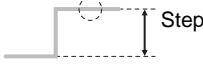
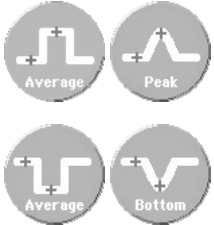

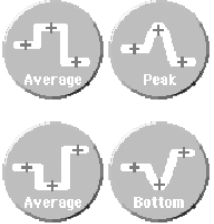

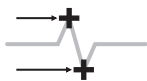

FUNCTION SETTINGS

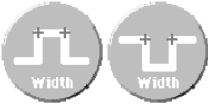
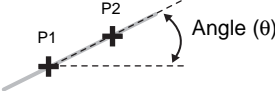
Setting Measurement Conditions	70
Customizing Measurement Conditions	87
Scaling of Measurement Values	91
Image Adjustment	96
Position Correction	106
Adjusting the Output Conditions of the Measurement Result	111
Setting Zero Reset	114
Bank Settings	116
System Settings	118

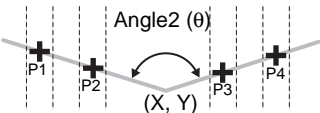
Setting Measurement Conditions

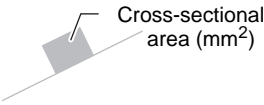

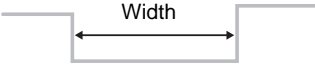
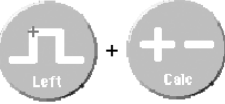



How to Select Measurement Items

Desired measurement	Measurement item and setting	Reference
Height 	Peak, bottom, average 	p.72
Height at which angle varies considerably Point of inflection  Point of inflector	Height measurement items  +[CUSTOM]-[POINT]-[BEND]	p.83
Step 	One reference plane 2-pt step measurement items 	p.74
Disparity (indentation and protrusion) between two reference planes 	3-pt step measurement items 	p.74
Position Position in X-direction Edge position Edge position 	Edge position measurement X items 	p.77

Desired measurement		Measurement item and setting	Reference
Position	Position of peak and bottom in X-direction 	Height measurement items  +[CUSTOM]-[POS.]-[X POS]	p.72 p.88
Width	Width 	Edge width measurement items 	p.77
Angle	 Angle (θ)	Angle measurement items 	p.79
Point of intersection on	 Angle2 (θ) (X, Y)	Point of intersection angle, point of intersection coordinate measurement items 	p.80
Cross-sectional area	 Cross-sectional area (mm ²)	Cross-sectional area measurement items 	p.82
Width	Measurement by two Sensor Heads  Controller CH1 Controller CH2	Controller CH1 Edge position measurement items + calculation  Controller CH2 Edge position measurement items 	p.77 p.86

Measuring Height

Three measurement items are provided according to the type of height measurement.

Item	Description
	
	
	

Flow of Operations

- 1 Assign the desired item from among the height-related measurement items to an unused task.

 step4 Selecting measurement items p.62

- 2 Enclose the desired measurement area.

The measurement region is automatically set.

In the EXP menu, select [AUTO] and set up this item.

- 3 Check that the region is set correctly.

When the region is not ideally set to the desired measurement position, select [CUSTOM]-[REGION] to adjust the region.

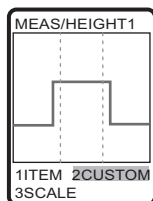
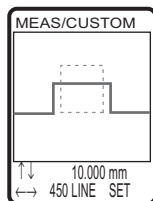
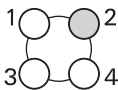

Note**Hint for adjusting the measurement region**

Adjust the start and end points of the measurement region so that the desired measurement position is enclosed.

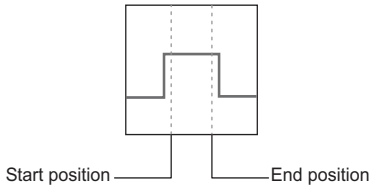
**Note****Custom settings available for height measurement**

Setting value	Description	Reference
REGION	Fine-adjusts the measurement region when it is not ideally set by AUTO.	–
MGNIFY	Magnifies the profile display.	p.87
POS. (measurement position)	Selects whether to output the position of the measurement value as the position in the height direction (Z coordinate) or as the position in the horizontal direction (X coordinate).	p.88
MEAS (enabled only in EXP menu)	Sets in more detail which height in the line beam that the target is to be measured at. Settings: AVE, PEAK, BTM, BEND	p.89

Measuring Step

Measures the step from the reference plane.

- When there is one reference plane, select “2-pt step”.
- When there are two reference planes, select “3-pt step”.

2-pt step

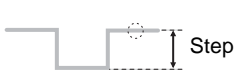



3-pt step



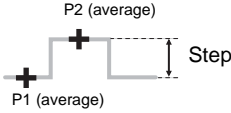

<2-pt step>

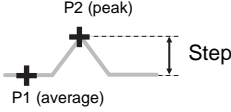
To measure a protrusion (+ direction) taking the base as the reference plane:

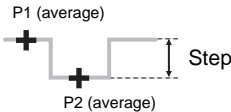

Item	Description	
 <p>Average</p>		Measures the step between the average values of P1 and P2.
 <p>Peak</p>		Measures the step between the average value of P1 and the maximum value of P2.

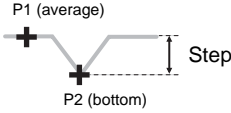
To measure an indentation (- direction) taking the top surface as the reference plane:

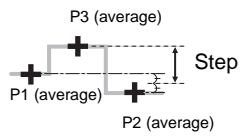

Item	Description	
 <p>Average</p>		Measures the step between the average values of P1 and P2.
 <p>Bottom</p>		Measures the step between the average value of P1 and the minimum value of P2.

<3-pt step>

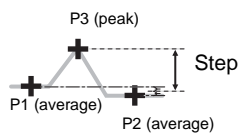
To measure a protrusion (+ direction) taking the base as the reference plane:

Item	Description
 <p>Average</p>	 <p>Measures the step between the average value of P3 taking the average values of both sides (P1, P2) as the reference plane.</p>
 <p>Peak</p>	 <p>Measures the step between the maximum value of P3 taking the average values of both sides (P1, P2) as the reference plane.</p>

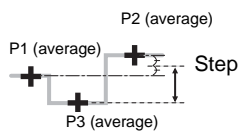
To measure an indentation (- direction) taking the top surface as the reference plane:

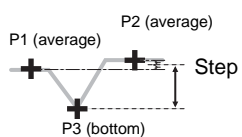
Item	Description
 <p>Average</p>	 <p>Measures the step between the average value of P3 taking the average values of both sides (P1, P2) as the reference plane.</p>
 <p>Bottom</p>	 <p>Measures the step between the minimum value of P3 taking the average values of both sides (P1, P2) as the reference plane.</p>

Flow of Operations

The following example describes how to set 2-pt step.

- 1 Assign the desired item from among the 2-pt step-related measurement items to an unused task.

 step4 Selecting measurement items p.62

2 Enclose the desired measurement area.

In the EXP menu, select [AUTO] and set up this item.

Important

Adjust the region so that the center line is aligned with the “mid point between the top and bottom of the step.”

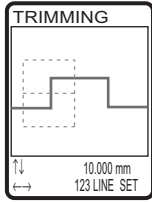
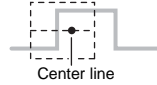

3 Check that the region is set correctly.

When the region is not ideally set to the desired measurement position, select [CUSTOM]-[REGION] to adjust the region for each measurement point.

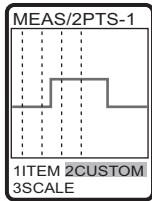
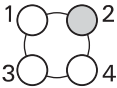

Note Hint for adjusting the measurement region

Adjust the start and end points of the region for each measurement point.

2-pt step

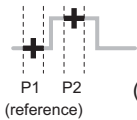

(step=P2-P1)

3-pt step

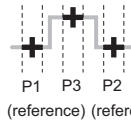

(step=P3-(P1+P2)+2)





Note Custom settings available for step measurement

Setting value	Description	Reference
REGION	Fine-adjusts the measurement region when it is not ideally set by AUTO.	-
MGNIFY	Magnifies the profile display.	p.87
POINT (enabled only in EXP menu)	Sets in more detail which height in the line beam that the target is to be measured at. Settings: AVE, PEAK, BTM	p.89



Measuring Position and Width

Performs measurement taking the point of intersection of the profile and the edge level as an edge.

<Edge position>

Item	Description
	<p>Edge position</p> 
	<p>Edge position</p> 

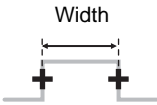
<Edge width>

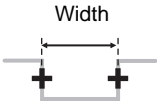
Item	Description
	<p>Width</p> 
	<p>Width</p> 

Flow of Operations

The following example describes how to set edge width.

- 1 Assign the desired item from the edge width-related measurement items to an unused task.

 step4 Selecting measurement items p.62

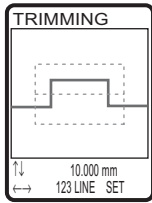

2 Enclose the desired measurement area.

In the EXP menu, select [AUTO] and set up this item.

Important

Adjust the region so that the center line is aligned with the “edge to be detected.”

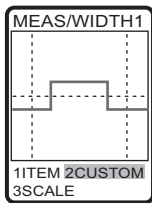
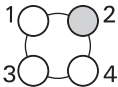
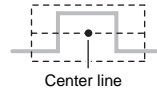

3 Check that the region is set correctly.

When the region and edge level are not ideally set to the desired measurement position, adjust each of region and edge level.

Note Hint for adjusting the measurement region

Adjust the start and end points of the measurement region, and edge level so that the desired measurement position is enclosed.

The edge level can be changed only in the EXP menu.

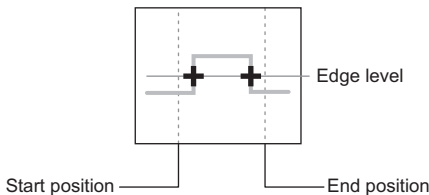

Note Custom settings available for position and width measurement



Setting value	Description	Reference
REGION	Fine-adjusts the measurement region when it is not ideally set by AUTO.	–
MGNIFY	Magnifies the profile display.	p.87
EDGELV (enabled only in EXP menu)	Selects the edge level and edge search direction.	p.90

Measuring Angle

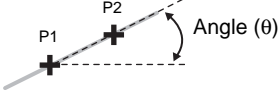
The angle of the profile inside the region is measured. Measurement of the angle is enabled only in the EXP menu.

Item	Description
 <p>Angle</p>	 <p>The average values inside the region are each extracted as points. A straight line is drawn between the two extracted points, and the angle formed by the intersection between that straight line and the X-axis is measured as the angle.</p>

Flow of Operations

- 1 **Switch to the EXP menu.**
 Switching the menu p.55
- 2 **Assign the angle measurement item to an unused task.**
 step4 Selecting measurement items p.62
- 3 **Select [CUSTOM]-[REGION], and set two regions on the line.**

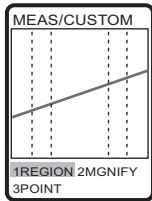

Note Custom settings available for angle measurement

Setting value	Description	Reference
MGNIFY	Magnifies the profile display.	p.87
POINT (measurement value)	Sets in more detail which height in the line beam that the target is to be measured at. Settings: AVE, PEAK, BTM	p.89

Measuring Angle and Point of Intersection

The angle at the point of intersection of two lines and point of intersection coordinates are measured. Measurement of the angle and point of intersection is enabled only in the EXP menu.

<Point of intersection angle>

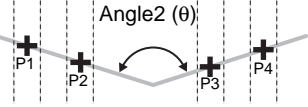

Item	Description
 <p>Angle2</p>	 <p>Extracts the average value of each region as points P1 to P4, respectively. Points P1/P2 and P3/P4 are each joined by a straight line, and the angle formed by the intersection lines is measured. The angle is calculated in the clockwise direction taking the line formed by joining points P1 and P2 as the reference.</p>

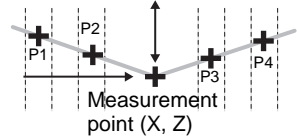
<Point of intersection coordinates>

Item	Description
 <p>Corner</p>	 <p>Extracts the average value of each region as points P1 to P4, respectively. Points P1/P2 and P3/P4 are each joined by a straight line, and the height (Z coordinate or position (X coordinate) of that point of intersection is measured.</p>

Flow of Operations

The following example describes how to set point of intersection angle.

- 1 **Switch to the EXP menu.**
 -  Switching the menu p.55
- 2 **Assign the point of intersection angle measurement item to an unused task.**
 -  step4 Selecting measurement items p.62



- 3 Select [CUSTOM]-[REGION], and set two regions each for the two straight lines.

Note

Custom settings available for angle and point of intersection measurement



Setting value	Description	Reference
MGNIFY	Magnifies the profile display.	p.87
POS (measurement position) (enabled only at point of intersection coordinate measurement)	Selects whether to output the position of the measurement value as the position in the height direction (Z coordinate) or as the position in the horizontal direction (X coordinate).	p.88
POINT (measurement point)	Sets in more detail which height in the line beam that the target is to be measured at. Settings: AVE, PEAK, BTM	p.89

Measuring Cross-sectional Area

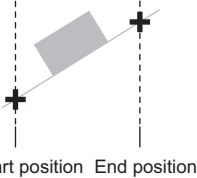
The cross-sectional area of the profile inside the region is measured. Measurement of the cross-sectional area is enabled only in the EXP menu.

Item	Description
 <p>Area</p>	 <p>The cross-sectional area of the object is measured. The cross-sectional area is calculated by integrating the distance between each of the measurement point and the bottom face, with the line formed between the two points that intersect the start and end points of the measurement region taken to be the bottom face.</p>

Flow of Operations

- 1** Switch to the EXP menu.
 -  Switching the menu p.55
- 2** Assign the cross-sectional area measurement item to an unused task.
 -  step4 Selecting measurement items p.62
- 3** Select [CUSTOM]-[REGION], and set the region for cross-sectional area measurement.

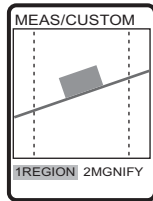

Note



Custom settings available for cross-sectional area measurement

Setting value	Description	Reference
MGNIFY	Magnifies the profile display.	p.87

Measuring Point of Inflection

Measures the height of the point (point of inflection) where the angle varies the most within a measurement region.

This item is useful for measuring positions that cannot be selected by the PEAK or BTM settings.

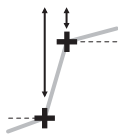
Item	Description
<p>Height-related measurement items</p> <div style="display: flex; flex-direction: column; align-items: center;"> <div style="display: flex; align-items: center; margin-bottom: 10px;">  <div style="margin-left: 10px;">Peak</div> </div> <div style="display: flex; align-items: center; margin-bottom: 10px;">  <div style="margin-left: 10px;">Average</div> </div> <div style="display: flex; align-items: center;">  <div style="margin-left: 10px;">Bottom</div> </div> </div>	<div style="display: flex; align-items: center;"> <div style="margin-right: 20px;"> <p>Height</p>  </div> <div> <p>Measures the height of the point where the angle varies the most within a measurement region.</p> </div> </div>

Flow of Operations

- 1** Switch to the EXP menu.

 Switching the menu p.55
- 2** Assign the desired item from among the height-related measurement items to an unused task.

 step4 Selecting measurement items p.62
- 3** Select [CUSTOM]-[REGION], and set the region.

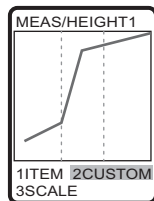
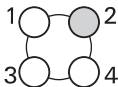

Note**Hint for adjusting the measurement region**

Adjust the start and end points of the measurement range so that the point of inflection to be detected is enclosed.

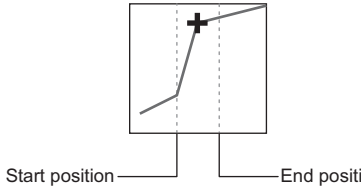

4 Select [CUSTOM]-[MEAS]-[BEND]-[TARGET].

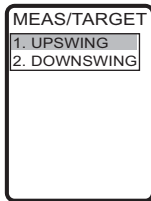

5 Select [DOWNSWING] or [UPSWING] to match the orientation of the point of inflection to be detected.

UPSWING/DOWNSWING
p.85

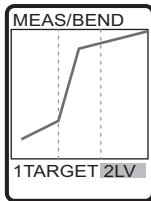

6 When noise, etc. prevents the profile from stabilizing, increase the [LV] setting.

Setting range: 1 to 5 (default value: 1)

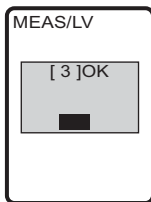

Note**UPSWING/DOWNSWING**

The ZG2 treats angles as follows.

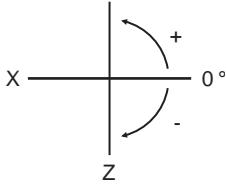

To measure the position where the angle of inclination is varying from “small → large,” select [UPSWING].

To measure the position where the angle of inclination is varying from “large → small,” select [DOWNSWING].

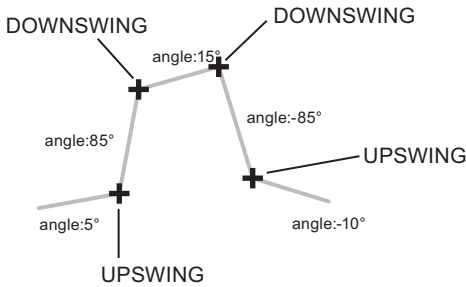

Calculating Measurement Values

<Calculation>

The measurement results of other tasks can be used for calculation. The calculation setting is enabled only in the EXP menu.

Item	Description
 Calc	<p>Set any equation to perform addition/subtraction on the measurement result. The equation can be substituted with measurement results obtained by other tasks. Also, when using two Controllers in a gang-mount configuration, calculations can also be performed across channels.</p> <p>Allowable equation: $K+mX+nY$</p> <ul style="list-style-type: none"> • EK range: -999.99999 to 999.99999 (default value: 0.00000) • Em/n range: -10.0 to 10.0 (default value: 1.0) • X/Y range: OFF (default value: OFF), TASK1 to TASK7 (Only task Nos. smaller than the task No. to which a calculation is set can be set.) <p>In a gang-mount configuration, select the channel first in the additional channel selection menu before setting the task number.</p>

 Measuring Wide Measurement Targets p.185

 Calculations Performed on Measurement Values Obtained on Multiple Channels p.190

Important

When Controllers are gang-mounted, set calculation on the Controller set as channel 1 (CH1). Calculation cannot be set on the CH2 Controlled.

Deleting measurement items

<Deleting measurement items>

Item	Description
 Delete	<p>Delete the measurement items that are set to the currently selected task.</p>

Customizing Measurement Conditions

Magnifying the Profile Display

A specified area of the profile display can be magnified.

► FUN mode-[MEAS]-[SENS]-[TASK1 to 8]-[CUSTOM]-[MGNIFY]

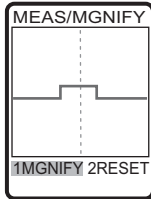
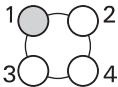

1 Select [MGNIFY].

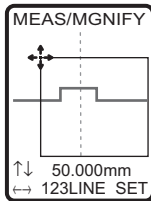
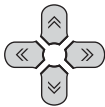

2 Adjust the top left of the desired measurement area by the ↑, ↓, ← and → keys, and press the SET key.

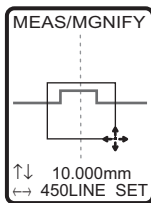
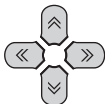

3 Adjust the bottom right of the desired measurement area by the ↑, ↓, ← and → keys, and press the SET key.

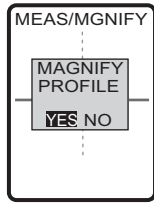
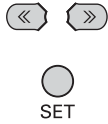

4 Move to [YES] and press the SET key.

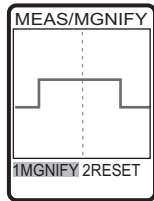

The profile in the specified area is displayed magnified.

Changing Measurement Positions

Select whether to output the position of the measurement value as the position in the height direction (Z coordinate) or as the position in the horizontal direction (X coordinate). Selection of measurement position is enabled when measuring height and point of intersection coordinates.

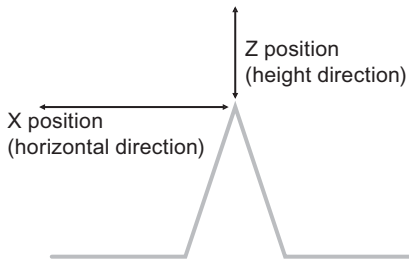

► FUN mode-[MEAS]-[SENS]-[TASK1 to 8]-[CUSTOM]-[POS.]



Setting value	Description
Z POS. (height direction)	Outputs the position of the measurement value as the position in the height direction (Z coordinate). (default value)
X POS. (horizontal direction)	Outputs the position of the measurement value as the position in the horizontal direction (X coordinate).

Changing Measurement Points

Any measurement point inside the received light area can be measured. Set this menu item when measuring small unevenness.

The measurement point setting is enabled only in the EXP menu.

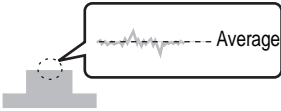
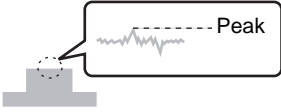
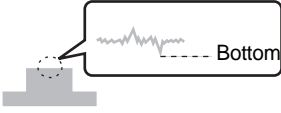
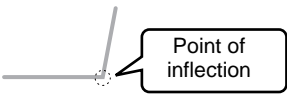
► FUN mode-[MEAS]-[SENS]-[TASK1 to 8]-[CUSTOM]-[POINT]

Setting value	Description
AVE (average)	<p>Measures the average value inside the line beam.</p> 
PEAK	<p>Measures the peak position of the line beam.</p> 
BOTTOM	<p>Measures the bottom position of the line beam.</p> 
BEND (point of inflection)	<p>Measures the height of the point (point of inflection) where the angle of the profile varies the most within a measurement region. This item is displayed only when the measurement item [HEIGHT] is set. This item is useful for measuring positions that cannot be selected by the PEAK or BTM settings.</p>  <p>Note Setting UPSWING, DOWNSWING and LV</p> <p> Measuring Point of Inflection p.83</p>

Changing the Edge Level and Edge Direction

Set the edge level and edge direction when selecting edge-related measurement items. These settings are enabled only in the EXP menu.

► FUN mode-[MEAS]-[SENS]-[TASK1 to 8]-[CUSTOM]-[EDGE LV]

Changing the edge level

Setting value	Description
Edge level	Align the line of the edge level with the edge to be detected. The range differs according to the CCD mode. Standard and high-resolution mode: 0 to 399 High-speed mode: 0 to 199

Selecting the edge direction

Set the edge search direction.

Setting value	Description
→ Forward direction	The "1st edge from the left" in the region is searched for.
← Reverse direction	The "1st edge from the right" in the region is searched for.

Scaling of Measurement Values

If scaling is set, differences between measurement values and actual sizes, that occur due to the color or material of the measurement target or other factors, can be corrected. There are two scaling setup modes, “automatic setting” and “manual setting.” In the automatic setting mode, actual measurement is performed, and in the manual setting mode, the correction values are set manually.

(default value: OFF)

Important

The settings below return to the default settings when scaling is set. Set these items after scaling settings have been completed.

- Zero reset

Automatic Setting Method

Measurement is actually performed, and correction values are set for those measurement values.

1-pt scaling

Measurement is performed once, and the actual size value for the measurement value is set. Set scaling by this method when 2-pt step, 3-pt step and edge width is set.

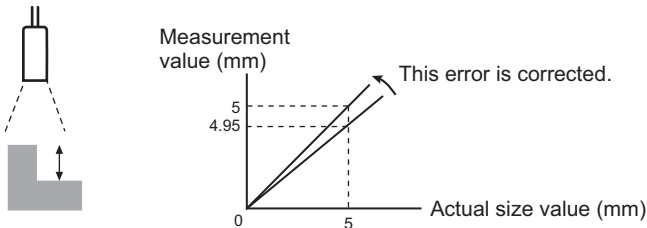

► FUN mode-[MEAS]-[SENS]-[TASK1 to 8]-[SCALE]-[AUTO]

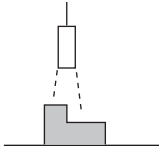

1 Set the measurement target in place, and press the SET key.

The measurement value is displayed.

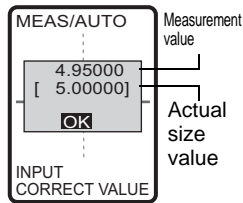
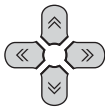
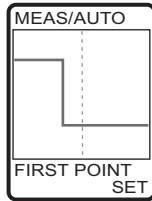

2 Input the actual size value on the lower section.

Note

To change numerical values, use the ↑ key/↓ key, and to change the number of digits use the → key/← key.

2-pt scaling

Measurement is performed at two positions, and actual size values are set for those measurement values. Set scaling by this method when height and edge position are set.

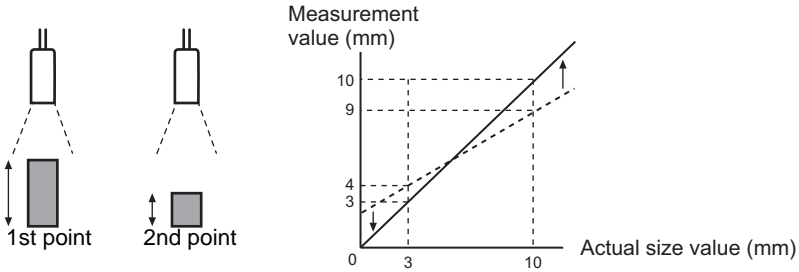

► FUN mode-[MEAS]-[SENS]-[TASK1 to 8]-[SCALE]-[AUTO]

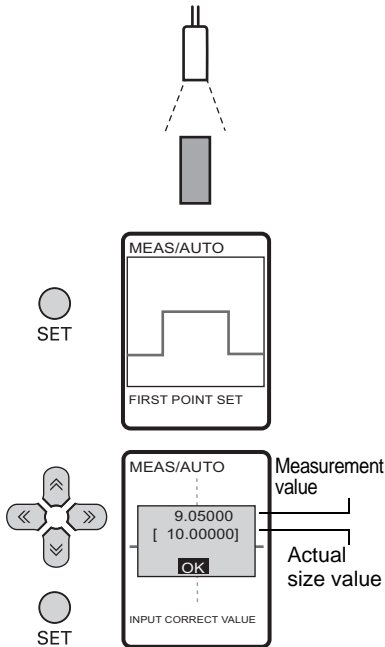

1 Set the measurement target in place, and press the SET key.

The measurement value is displayed.

2 Input the actual size value on the lower section.

Note

To change numerical values, use the ↑ key/↓ key, and to change the number of digits use the → key/← key.

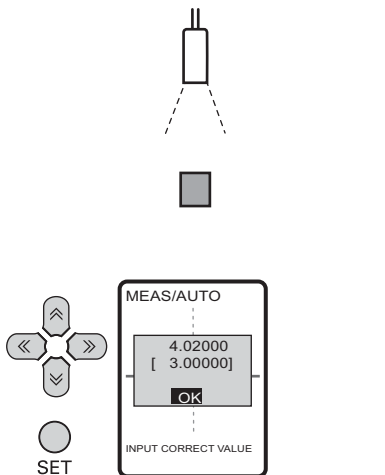

3 Move the position of the measurement target, and press the SET key.

The measurement value is displayed.

4 Input the actual size value on the lower section.

Manual Setting Method

Span and offset can be set by inputting numerical values manually to fine-tune the measurement values. These can be set for each individual task. Span and offset are automatically set after scaling is executed. So, modify these settings as necessary. Set scaling by this method when angle, point of intersection angle, point of intersection coordinates, and cross-sectional area are set. Manual setting is enabled only in the EXP menu.

► FUN mode-[MEAS]-[SENS]-[TASK1 to 8]-[SCALE]-[MANUAL]

Setting value	Description
SPAN	<p>Sets the inclination of the sensor characteristics as a coefficient. Range: -4.0000 to 4.0000</p>  <p>The diagram for SPAN shows a coordinate system with a vertical axis labeled 'Measurement value (mm)' and a horizontal axis labeled 'Displacement of measurement target'. A solid line passes through the origin, representing the sensor's characteristic. A dashed line also passes through the origin, representing the target's characteristic. The angle between the solid and dashed lines is indicated by a curved arrow and labeled with '4.0000' at the top and '-4.0000' at the bottom.</p>
OFFSET	<p>Adds/subtracts a fixed value to or from the measurement value. Range: -999.99999 to 999.99999</p>  <p>The diagram for OFFSET shows a coordinate system with a vertical axis labeled 'Measurement value (mm)' and a horizontal axis labeled 'Displacement of measurement target'. A solid line passes through the origin, representing the sensor's characteristic. A dashed line is parallel to the solid line, representing the target's characteristic. A vertical double-headed arrow between the solid and dashed lines is labeled 'Displacement of measurement target'.</p>

Image Adjustment

Adjusting Sensitivity

The sensitivity of the Sensor Head can be adjusted so that shapes are accurately captured even if the shape, color, material, etc. of the measurement target is influenced. The default setting is [MULTI].

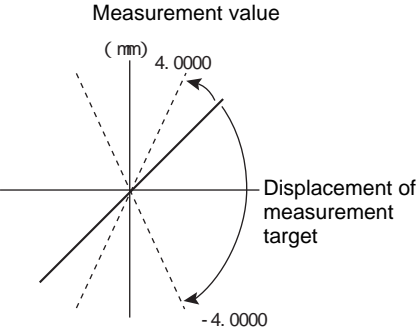
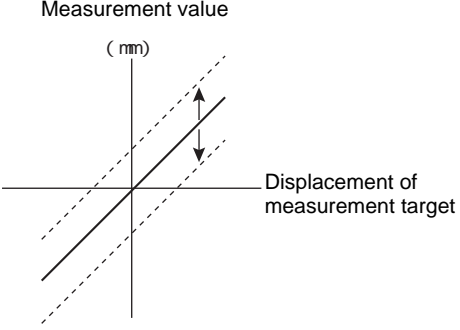

Sensitivity Adjustment Functions of the ZG2 Series p.26

► FUN mode-[MEAS]-[IMAGE]-[LD-POWER]

Setting value	Description
HS_MULTI (high-speed MULTI)	This is a higher speed version of the MULTI mode. This method is suitable when the brightness of the measurement target surface fluctuates to a large degree but the measurement tact time must be increased.
MULTI	Measurement is performed with the sensitivity adjusted for each individual line in the measurement region. This method is suitable when the brightness of the measurement target surface fluctuates to a large degree.
AUTO	Measurement is performed with the sensitivity adjusted automatically based on the sensitivity information in the measurement region. This method is suitable when the brightness of the measurement target surface is uniform.
FIXED	Measurement is performed with the sensitivity fixed. This method is suitable when accurate measurements cannot be made at the [AUTO] setting, for example, for lines on which measurement targets of various colors are fed alternately.

Important

[MULTI] and [HS MULTI] are effective as a sensitivity adjustment function only when measuring stationary measurement targets. When the measurement target cannot be made stationary, use [AUTO] or [FIXED].

Note

Measurement cycle

The measurement cycle differs according to the preset sensitivity. The measurement cycle can be checked by the ECO monitor in the RUN mode.



Eco monitor p.67

Detailed setting of sensitivity adjustment

The sensitivity adjustment upper/lower limits and interval can be adjusted in the EXP menu.

LD-POWER

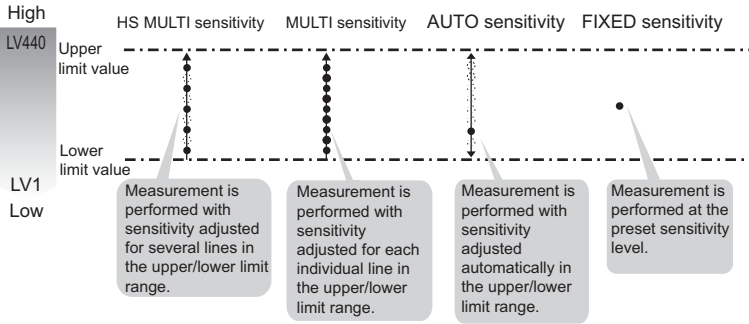

Detailed setting of HS MULTI (high-speed MULTI) sensitivity

► FUN mode-[MEAS]-[IMAGE]-[LD-POWER]-[HS MULTI]

Setting value		Description
CUSTOM	HIGH	Sets the sensitivity adjustment upper limit. Range: LV1 to LV440 (default value: LV320) (when high power mode is used, LV1 to LV320)
	LOW	Sets the sensitivity adjustment lower limit. Range: LV1 to LV440 (default value: LV1) (when high power mode is used, LV1 to LV320)
	IMAGE NUM (lighting count)	Sets the lighting count when measurement is executed. Setting range: 2 to 10 (default value: 5) The measurement time becomes proportionately shorter as a smaller lighting count is set. However, measurement sometimes becomes unstable. If this happens, set a larger lighting count value.
SEARCH		The optimum lighting sensitivity is set automatically matched to the measurement target set in place.

Important

- When [HS MULTI] is selected, be sure to execute [SEARCH]. Otherwise, the lighting sensitivity will not be set to the optimum value.

Detailed setting of MULTI sensitivity

► FUN mode-[MEAS]-[IMAGE]-[LD-POWER]-[MULTI]

Setting value		Description
CUSTOM	HIGH	Sets the sensitivity adjustment upper limit. Range: LV1 to LV440 (default value: LV320)
	LOW	Sets the sensitivity adjustment lower limit. Range: LV1 to LV440 (default value: LV1)
	STEP (interval)	Sets the sensitivity adjustment interval. <ul style="list-style-type: none"> • Fine adjustment: LV5 increments • Standard: LV10 increments (default value) • Rough adjustment: LV20 increments
SEARCH		The upper and lower limits are set automatically matched to the measurement target.

Note

Examples of Effective Sensitivity Adjustment

- To measure the shape of the measurement target in detail:
Set a small interval (rough adjustment → standard → fine adjustment).
- The processing time when the upper limit is set to LV440 becomes approximately 10 ms.

Detailed setting of AUTO sensitivity

► FUN mode-[MEAS]-[IMAGE]-[LD-POWER]-[AUTO]

Setting value		Description
CUSTOM	HIGH	Sets the sensitivity adjustment upper limit. Range: LV1 to LV440 (default value: LV320) (when high power mode is used, LV1 to LV320)
	LOW	Sets the sensitivity adjustment lower limit. Range: LV1 to LV440 (default value: LV1) (when high power mode is used, LV1 to LV320)

Setting of FIXED sensitivity level

► FUN mode-[MEAS]-[IMAGE]-[LD-POWER]-[FIXED]

Setting value	Description
LV0 to 320	Sets the fixed sensitivity level to be used. Range: LV0 to LV440 (default value: LV160) (when high power mode is used, LV1 to LV320) When LV0 is set, laser emission is turned OFF.

Changing Sensitivity Adjustment Region

Extremely bright parts or areas other than the measurement target sometimes cause the sensitivity adjustment to become unstable. If this happens, measurement can be made stable by adjusting the sensitivity adjustment region to restrict the area to be adjusted for sensitivity.

Important

Adjustment in the Z direction of the measurement region is limited to the inside of the sensitivity adjustment region.

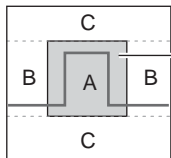

Sensitivity adjustment region

- A: This region is targeted for both sensitivity adjustment and measurement.
- B: This region is outside the sensitivity adjustment target area, and is targeted for measurement only.
- C: This region is outside the measurement target area, and the measurement image is deleted.

► FUN mode-[MEAS]-[IMAGE]-[REGION]

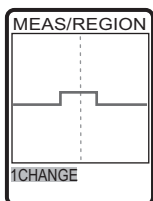
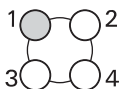

1 Select [CHANGE].

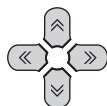

○
SET

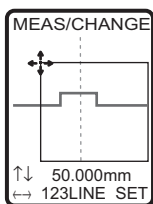

2 Adjust the top left of the desired measurement area by the ↑, ↓, ← and → keys, and press the SET key.

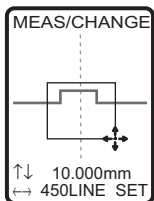
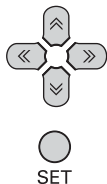

- 3** Adjust the bottom right of the desired measurement area by the ↑, ↓, ← and → keys, and press the SET key.

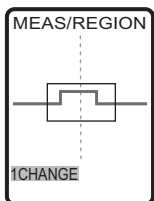

The measurement region is set to the specified area.

Adjusting Profiles

Noise filtering, output at measurement failure, and other options can be set in more detail. Adjust the conditions when the measurement cannot be performed properly. Setting of profiles is enabled only in the EXP menu.

Setting the inspection target

Select the surface shape of the measurement target.

When the inspection target is set, measurement and inspection of transparent objects (e.g. lenses and glass plates) can be performed correctly.

► FUN mode-[MEAS]-[IMAGE]-[PROFILE]-[OBJECT]

Setting value	Description
MAX PEAK	Normally, use this setting. (default value)
1ST PEAK	Use this item to stably measure the surface of transparent bodies.

Setting the average number of times

Changes in data are smoothed out using the average values of adjacent data. Smoothing is performed in the “width direction (X-axis direction).”

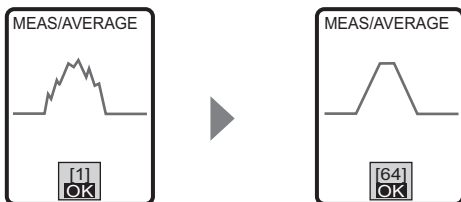

► **FUN mode-[MEAS]-[IMAGE]-[PROFILE]-[AVERAGE]**

Setting value	Description
1, 2, 4, 8, 16, 32, 64	Sets the number of data to average. (default value: 1)

Important

When measuring edge position and edge width, set the average number of times to “1”. Setting to a value other than “1” will result in a drop in the measurement accuracy.

Note

Averaging is not performed for the data on the right edge because the required number of samples cannot be obtained.

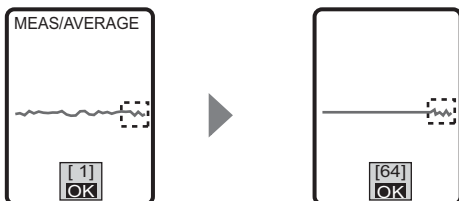

Setting the smoothing function

Changes in data are smoothed out using the intermediate values of adjacent data. Smoothing is performed in the “width direction (X-axis direction).” This setting is effective in filtering noise such as spikes.

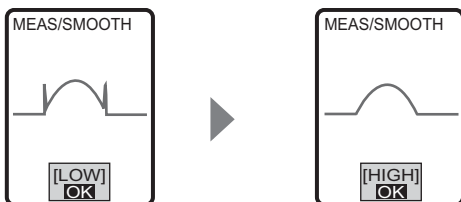

► **FUN mode-[MEAS]-[IMAGE]-[PROFILE]-[SMOOTH]**

Setting value	Description
OFF, LOW, MID, HIGH	Sets the smoothing strength. (default value: LOW)

Setting the interpolation method

This is used for interpolating between data in areas where profile data is missing (areas where measurement is not possible). If there are lines where the measurement target cannot be measured due to different degrees of reflectance or other causes, the data of such lines can be obtained by interpolating between the data acquired for the lines that allow measurement as desired.

Example: Profile output result when there are areas where measurement data cannot be obtained

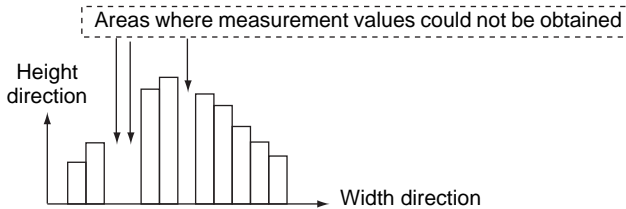

OFF (interpolation is not performed)

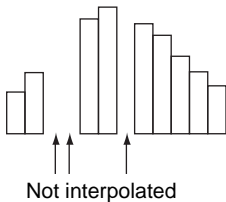

ON (linear interpolation is performed)

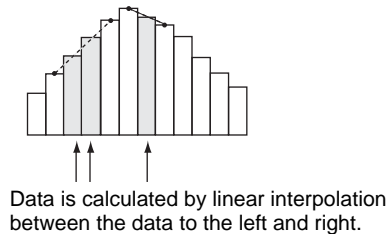

► FUN mode-[MEAS]-[IMAGE]-[PROFILE]-[FILLUP]

Setting value	Description
OFF	A measurement error signal is output for each area where measurements could not be obtained.
ON	Data for areas where measurements could not be obtained is calculated by linear interpolation between the data to the left and right. Up to 64 missing data values can be obtained by this method. (default value)

Setting the number of interpolated pixels

Set the number of pixels to be interpolated when interpolating profile data. Profile data is interpolated only if missing areas (areas where measurement data cannot be obtained) contain less than the specified number of pixels. Interpolation is not performed if a number of pixels greater than the specified number cannot be measured continuously. This feature can be applied, for example, to the measurement of measurement targets with holes in them.

Example: When the number of interpolated pixels is set to 2

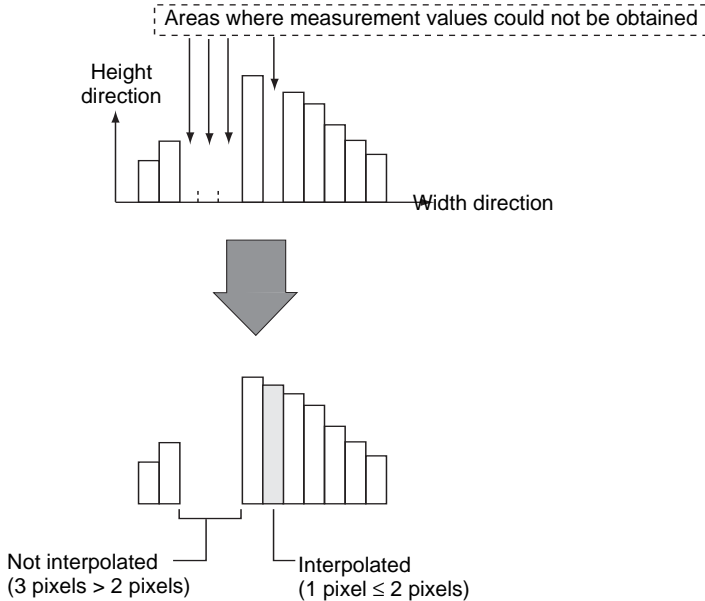

► FUN mode-[MEAS]-[IMAGE]-[PROFILE]-[SUPnum]

Setting value	Description
1, 2, 4, 8, 16, ALL (unit: pixels)	Interpolation is performed when missing areas contain less than the specified number of pixels. When [ALL] is selected, interpolation is performed on the entire profile regardless of the number of pixels. (default value: 4)

Adjusting the background filtering level

Pixels in the received light image whose density is at the preset background filtering level or less are judged to be noise, and can be omitted from the extraction target of the profile. This enables profiles to be displayed stably even when measuring targets with poor reflectance or when measurement is influenced by external light.

► FUN mode-[MEAS]-[IMAGE]-[CUT]

Setting value	Description
0 to 255	When the profile is incomplete due to poor reflectance from the measurement object and a dark image: Setting a lower setting value enables the profile to be displayed normally. When the profile is disrupted by external light: Setting a higher setting value enables the profile to be displayed normally. (default value: 25)

Note

- The APS setting function enables the optimum value to be set.

 APS function p.60

- If the profile cannot be detected normally even after changing the background filtering level setting value, adjust the received light gain.

 Adjusting received light gain p.105

Setting noise filtering

Noise filtering is used when waveform breaks appear in the profile. Noise components, the cause of waveform breaks, can be filtered out.

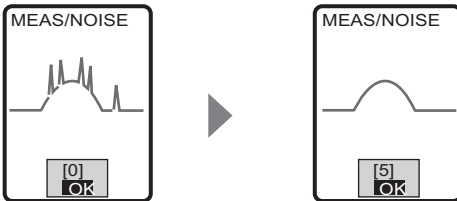

► FUN mode-[MEAS]-[IMAGE]-[NOISE]

Setting value	Description
0 to 7 (pixel)	Light received signals of width smaller than the specified size are filtered as noise. (default value: 0)

Setting the high-power mode (increasing the amount of emitted light)

This setting increases the amount of light emitted from the Sensor Head. This function is effective when measuring black measurement targets or there is little light reflected from the measurement target.

► FUN mode-[MEAS]-[IMAGE]-[HI-POWER]

Setting value	Description
OFF	Normally, use this setting. (default value)
ON	Increases the amount of light emitted from the Sensor Head.

Important

When the high-power mode is set to ON, the cycle per lighting becomes longer. The shortest measurement cycle becomes 95 ms regardless of the CCD mode setting. The actual measurement cycle can be checked by the ECO monitor in the RUN mode.



Eco monitor p.67

Adjusting received light gain

This setting is used when the profile cannot be detected normally even after changing the background filtering level setting value. The received light gain can be changed when insufficient light intensity prevents profiles from being displayed normally. The received light gain setting is enabled only in the EXP menu.

► FUN mode-[MEAS]-[IMAGE]-[GAIN]

Setting value	Description
LV1, LV2, LV3, LV4, LV5, LV6, LV7	Any received light gain within the range LV1 to LV7 can be set. Setting a larger LV setting increases the received light gain factor, and gradually adjusts the received light to reproduce a lighter image. (default value: 1)

Position Correction

Set the reference position and correction direction to correct position shift of the measurement target. The measurement value when these are set is registered as the reference position. So, place the measurement target at the correct position before you start settings.

Important

When multiple corrections are set, correction is executed in the following order of priority.

The following describes corrections (2) to (4) for position shift of the measurement target.
 (1) Sensor Head inclination correction → (2) Inclination correction → (3) Height correction → (4) Position correction

 Sensor Head Inclination Correction p.118

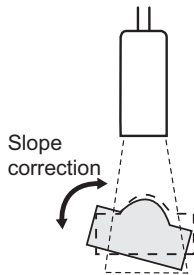

Region for calculating the angle amount of the measurement target

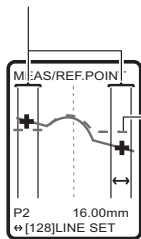

Set to enclose the position where the height of these two points can be measured even if the measurement target is inclined.

Angle to be registered as the reference

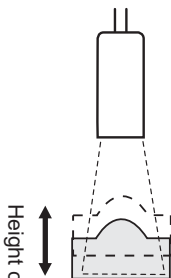

Region for measuring the amount of position shift

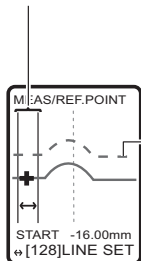

Set the area at a position where the height can be measured as the reference even if the measurement target moves vertically. The position cannot be corrected properly if the region contains a protrusion. Allow sufficient margin when setting the region.

Height to be registered as the reference

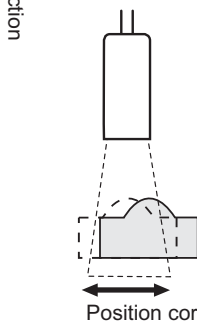

Edge detection level for measuring the amount of position shift

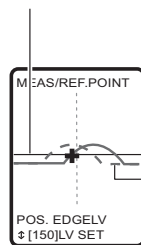

Set this level at a location where the target edge can be detected even if the measurement target moves horizontally.

Position to be registered as the reference

Slope Correction

Registering the reference position

Register the reference position.

► FUN mode-[MEAS]-[CORECT]-[SLOPE]-[REF.POINT]

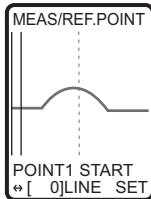

- 1** Set the measurement target in place, and press the SET key.

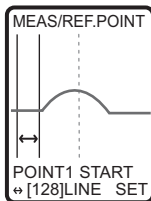

- 2** Specify the start and end lines for point 1.

←/→ key: Moves the cursor.

SET Key: Applies the setting.

ESC Key: Cancels the setting.

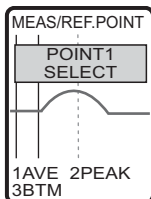
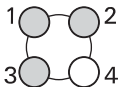

- 3** Select the measurement point to be used as the reference.

Select which position (average, peak or bottom) within the specified region is to be taken as the measurement point.

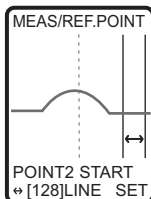

- 4** Specify the start and end lines for point 2.

←/→ key: Moves the cursor.

SET Key: Applies the setting.

ESC Key: Cancels the setting.

Setting correction ON/OFF

Set inclination correction ON/OFF.

► FUN mode-[MEAS]-[CORECT]-[SLOPE]-[CORECT]

Setting value	Description
OFF	Position correction in the slope direction is not performed. (default value)
ON	Position correction in the slope direction is performed.

Increasing the speed of slope correction

Correction is calculated to prevent measurement error from occurring due to the angle when performing slope correction.

When correction calculation is turned OFF, slope correction can be performed at a faster speed.

► FUN mode-[MEAS]-[CORECT]-[SLOPE]-[CORECT]

Setting value	Description
ON	Calculation of angle error in the measurement value caused by slope correction is performed. (default value) Measurement accuracy error is reduced but the measurement time increases. (approx. 10 ms)
OFF	Calculation of angle error in the measurement value caused by slope correction is not performed. Processing is performed faster, but an error in the measurement accuracy occurs in the case of a large angle.

Height/Position Correction

Registering the reference position

Register the reference position.

► FUN mode-[MEAS]-[CORECTSET]-[HGT POSN]-[REF.POINT]

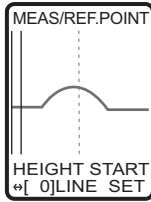

- 1** Set the measurement target in place, and press the SET key.

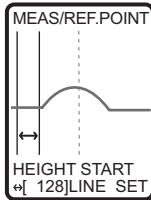

- 2** To correct shift in the height direction, specify the start and end lines.

←/→ key: Moves the cursor.

SET Key: Applies the setting.

ESC Key: Cancels the setting.

Important

Leave the default setting as it is if correction in the height direction is not necessary.

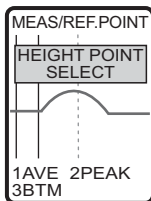
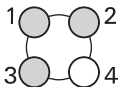

- 3** Select the measurement point to be used as the reference.

Select which position (average, peak or bottom) within the specified region is to be taken as the measurement point.



SET

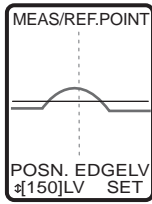

- 4** To correct shift in the position direction, align the line of the edge level to be detected.

←/→ key: Moves the cursor.

SET Key: Applies the setting.

ESC Key: Cancels the setting.

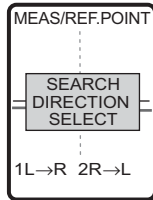
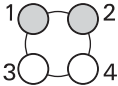

- 5** Select the direction in which edges are searched.

Select → (forward direction) or ← (reverse direction).



SET

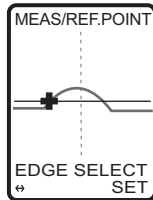

- 6** A cross cursor is displayed at the reference position. Press the ←/→ key to select the edge, and press the SET key.

Setting the correction method

Sets correction ON/OFF in both the height and position directions.

► FUN mode-[MEAS]-[CORECT]-[HGT POSN]-[METHOD]

Setting value	Description
OFF	The position is not corrected. (default value)
HEIGHT (height correction)	Correction is performed in the height direction.
POSITION (position correction)	Correction is performed in the position direction.
HGT POSN (height/position correction)	Correction is performed in both the height and position directions.

Adjusting the Output Conditions of the Measurement Result

Setting the Average Number of Measurements

The average of the set number of measurements can be output as the measurement result. Set this function to disregard sudden changes in the measurement values.

▶ ADJ mode-MENU/VIEW key-[FILTER]-[AVE]

Setting value	Description
1, 2, 4, 8, 16, 32, 64, 128, 256	Sets the average number of measurements. (default value: 1)

Note

- To change numerical values, use the ↑ key/↓ key.
- The calculation method for the average values differs according to the measurement trigger and sensitivity adjustment settings.

	HSMULTI sensitivity	MULTI sensitivity	AUTO sensitivity	FIXED sensitivity
Trigger disable	Moving average	Moving average	Moving average	Moving average
Trigger enable	Simple average	Simple average	Moving average	Simple average

- Moving average: The average value is output from the past N number of results.
- Simple average: Measurement is performed for N number of times, and the average value of these measurements is output.

Setting Smoothing

The intermediate value of past measurement results can be output as the measurement value. This function removes any abnormal values, such as spiking, that occur when the measurement result suddenly changes during measurement.

▶ ADJ mode-MENU/VIEW key-[FILTER]-[SMOOTH]

Setting value	Description
OFF, LOW, MID, HIGH	Sets the smoothing strength. (default value: LOW) The intermediate value of the past measurement values for the preset filter value at each individual measurement cycle is set as the measurement result.

Important

Smoothing is invalid when the measurement trigger and sensitivity adjustment settings are combined as follows. (Smoothing is not executed even if it is set.)

- Trigger enabled + MULTI sensitivity
- Trigger enabled + FIXED sensitivity
- Trigger enabled + HS MULTI sensitivity

Setting the Hold Function

Set the conditions for holding measurement values.

The “hold” function holds (retains) values such as “max. value” or “min. value” specified in the measurement values that are output within a fixed period of time, or “sampling period.” This function is convenient for when you want to use measurement results obtained at a specific measurement time.

Note

Start/end of the sampling period is instructed by the TRIG signal.



Assignments and Functions of I/O Signal Wires p.128

► ADJ mode-MENU/VIEW key-[OUT]-[HOLD]-[TYPE]

Setting value	Description
OFF	Hold measurement is not performed. Measurement values are output at all times. (default value)
PEAK	<p>The “maximum value” in the sampling period is held. The output measurement value is held at the same value for one sampling period, that is, until the next sampling period ends.</p>
BOTTM	<p>The “minimum value” in the sampling period is held. The output measurement value is held at the same value for one sampling period, that is, until the next sampling period ends.</p>
P-P	<p>The “difference between the max. value and min. value” in the sampling period is held. The output measurement value is held at the same value for one sampling period, that is, until the next sampling period ends.</p>

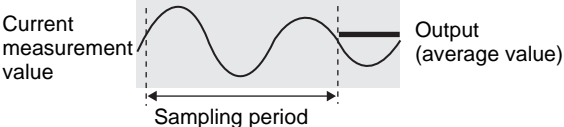
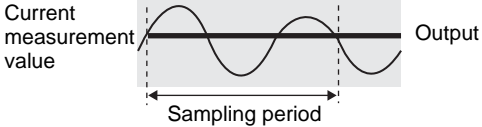
Setting value	Description
AVERAGE	<p>The “average of the measurement values” in the sampling period is held. The output measurement value is held at the same value for one sampling period, that is, until the next sampling period ends.</p> 
SAMPLE	<p>The measurement value instantaneously obtained at the start of the sampling period is held. The output measurement value is held at the same value between two sampling periods, that is, until the next sampling period starts.</p> 

Setting Zero Reset

Setting the Offset Value

To set a reference value for zero reset to a value other than 0 (zero), set the offset amount using this function. After setting any target value, execute a zero reset in the RUN mode.

 Executing Reference Zero Reset p.115

▶ ADJ mode-MENU/VIEW key-[OUT]-[ZERO]

Setting value	Description
ZERO	Sets the offset amount. Range: -999.99999 to +999.99999 (default value: 0)

Note

To change numerical values, use the ↑ key/↓ key, and to change the number of digits use the ← key/→ key.

Executing Reference Zero Reset

When the zero reset function is used, the reference value "0" is registered as the height, and the measured value can be displayed and output as a positive or negative deviation (tolerance) from the reference value. In the RUN mode, the measured value can be reset to "0" at any time during measurement.



Zero Reset indicator

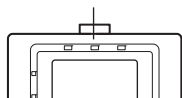

- 1** Switch to the RUN mode.
- 2** Set the object to be used as the reference in place.

- 3** Press the SET key.
The Zero Reset indicator lights, and the current measured value is registered as 0 (zero).

Note

- To cancel a zero reset, press and hold the ESC key for 2 seconds or longer.
- Zero reset can also be executed and canceled by an external input.
- A value other than zero also can be set as the zero reset reference value.



Setting the Offset Value p.114

Bank Settings

The ZG2 can hold up to 16 sets of settings, which are called a “bank”. Bank 1 is displayed as the default bank when the Smart Sensor is turned ON. Banks 2 to 16 are also provided in addition to this.

 Tasks and Bank Data p.53

Bank Switching (change of device setup)

The currently selected bank can be switched to other banks. Switching of banks is instructed by operating Controller keys, external signals or communication commands.

► FUN mode-[BANK]-[SWITCH]

Setting value	Description
BANK1 to BANK16	Selects the target bank. (default value: BANK1)

Note

 Switching banks by external signals p.129
Switching banks by communication commands p.160

Copying Bank Data

The settings of other banks can be copied to the current bank.

► FUN mode-[BANK]-[COPY]

Setting value	Description
BANK1 to BANK16	Selects the copy source bank. (default value: BANK1)

Important

After executing a bank copy, switch to the RUN mode once to save the settings. Settings are cleared when the Smart Sensor is turned OFF after you just copy the settings.

Clearing Bank Data

The content of banks can be cleared.

Important

Settings in [System] and [I/O] are not cleared.

► FUN mode-[BANK]-[CLEAR]

Setting value	Description
YES	The content of the currently selected bank is cleared.
NO	The content of the currently selected bank is not cleared.

System Settings

Setting the Sensor Head Installation Status

Regular Reflection/Diffuse Reflection

Set how the Sensor Head is installed. This setting is automatically specified according to the type of the connected Sensor Head. However, if the Sensor Head is installed at an angle, and the default value and reflection angle are changed, change the settings according to the status of the Sensor Head installation.

► FUN mode-[SYSTEM]-[HEAD SET]-[SET]

Setting value	Description
DIFFUSE (diffuse reflection)	Select this item when the Sensor Head is installed for diffuse reflection measurement.
REGULAR (regular reflection)	Select this item when the Sensor Head is installed for regular reflection measurement.

Sensor Head Inclination Correction

This function corrects error caused by shifting of the inclination between the Sensor Head and reference plane of the measurement target. The measurement target is actually measured and the correction value is registered.

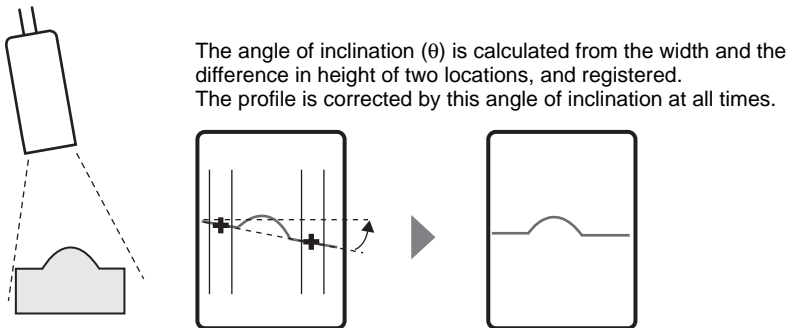

Important

The registered slope correction is cleared when the following settings are changed:

- CCD mode
- Sensor Head installation

► FUN mode-[SYSTEM]-[HEAD SET]-[CORECT]-[INCLINATION]

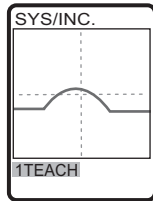
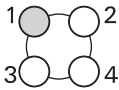

1 Set the measurement target in place, and select [TEACH].

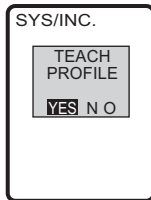

2 Move to [YES] and press the SET key.

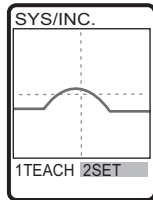
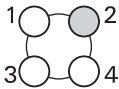

3 Select [SET].

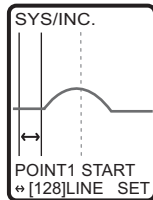

4 Specify the start and end lines for point 1.

←/→ key: Moves the cursor.

SET Key: Applies the setting.

ESC Key: Cancels the setting.

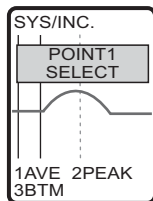
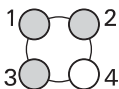

5 Select the measurement point.

Select which position (average, peak or bottom) within the specified region is to be taken as the measurement point.

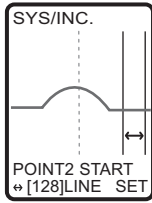
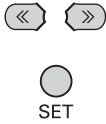

6 Specify the start and end lines for point 2.

←/→ key: Moves the cursor.

SET Key: Applies the setting.

ESC Key: Cancels the setting.

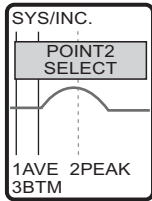
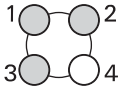

7 Select the measurement point.

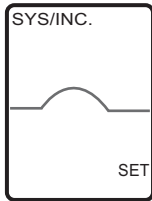

8 Press the SET key to apply the setting.

Setting correction ON/OFF

Set Sensor Head inclination correction ON/OFF.

► FUN mode-[SYSTEM]-[HEAD SET]-[CORECT]-[CORECT]

Setting value	Description
OFF	Sensor Head inclination correction is not performed. (default value)
ON	Sensor Head inclination correction is performed.

Setting the CCD Mode

Set the resolution of the Sensor Head's CCD. The profile can be set to high-resolution or the response time can be speeded up by changing the CCD mode.



Three CCD Modes and Their Characteristics p.23

Important

When the CCD mode is changed, the bank data is initialized. So, be sure to start with teaching again.

► FUN mode-[SYSTEM]-[CCD MODE]

Setting value	Description
NORMAL (standard mode)	Standard measurement is performed. (default value)
HI-RESO (high-resolution mode)	Measurement is performed at a resolution of about four times that of the standard mode (about two times when the ZG2-WDS70 Sensor Head is used).
HI-SPEED (high-speed mode)	Measurement is performed at a higher speed than that of the standard mode. This mode is suited to measurement of shapes in fast line speed processes as the measurement cycle is fast. Note that the possible measurement range in the height direction becomes roughly 1/2 of that in the standard mode.

Setting the Sensor Head Data Loading Method

Various data is saved in the Sensor Head. Set at which timing this information is to be loaded to the Controller.

► FUN mode-[SYSTEM]-[HEAD DATA]

Setting value	Description
HEAD	Reads the data currently saved on the Sensor Head each time that the Controller is started up. (default value)
Controller	Data is not read from the Sensor Head when the Controller is started up if the same Sensor Head at the previous startup is connected. Important When the combination of Controller and Sensor Head is fixed, selecting "CONTROLLER" sometimes results in the Controller starting up more stably depending on the operating environment.

Setting the Number of Digits Past the Decimal Point

Set the number of display digits past the decimal point that are displayed in the measurement result on the monitor. When five or less digits are set, the digits are disabled from the rightmost digit first.

► FUN mode-[SYSTEM]-[DIGIT]

Setting value	Description
5, 4, 3, 2, 1	Sets the number of display digits past the decimal point. (default value: 3)

Note

The number of digits past the decimal point in serial output follows the setting made here.

Setting/Changing the ECO Display

This function darkens the LCD screen to suppress current consumption when control keys or selection switches are not operated for three minutes or longer.

► FUN mode-[SYSTEM]-[ECO MODE]

Setting value	Description
ON	The ECO mode setting is enabled. (default value)
OFF	The ECO mode setting is disabled.

Displaying the Controller Information

You can display the system version of the Sensor Head and Controller. This information allows you to check the Sensor Head type, serial No., Controller type and version information.

► FUN mode-[SYSTEM]-[INFO]

Setting/Changing the Display Language

Set the display language of the LCD screen.

► FUN mode-[SYSTEM]-[LANGUAGE]

Setting value	Description
JAPANESE	Displays menus in Japanese.
ENGLISH	Displays menus in English.

Setting the Icon Color

You can set the color of icons.

► FUN mode-[SYSTEM]-[ICON]

Setting value	Description
ORANGE	The icon color is set to orange. (default value)
BLUE	The icon color is set to blue.
GREEN	The icon color is set to green.
MONOTONE	The icon color is set to monotone.

Saving the Setup Data

Bank settings and system settings are saved internally on the Controller.

Important

- The settings of all banks are saved regardless of the currently selected bank No.
- After you have made or changed settings, be sure to save the setup data. All settings will be deleted if you turn the power OFF without saving the data. A message prompting you to save data will be displayed if you change to the RUN mode without saving data after you have changed settings.

► FUN mode-[SYSTEM]-[SAVE]

Setting value	Description
YES	Saves the setup data.
NO	Does not save the setup data.

CONNECTION WITH EXTERNAL DEVICES

Output Data List	126
Using the Controller I/O Cable	127
Using the Parallel Output Unit (sold separately)	138
I/O Timing Charts	144
Serial Communication	149

Output Data List

The ZG2 series can output 3 types of data (measurement values, judgment values and profile data) to external devices. All output data on the ZG2 series can be obtained by serial communication.

Measurement value (result for each individual task)

Output path	Description
Controller analog output	1 task is output as an analog value.
Parallel Output Unit	1 task is output in 16-bit binary format.
Serial communication	The results of all tasks or each individual task are output as ASCII code.

Profile

Output path	Description
Controller I/O cable	(No output)
Parallel Output Unit	(No output)
Serial communication	631 Profile data of 631 points is output as ASCII code or in binary format.

Judgment value (result for each individual task)

Output path	Description
Controller I/O cable	The overall judgment of all tasks is output. The following output is performed on registered tasks: ALL PASS: This output is turned ON when all judgment results are OK. NG: This output turns ON when even one measurement result is NG. ERROR: This error turns ON when there is even one measurement error.(ERROR has higher priority over NG.)
Parallel Output Unit	Judgment values are output for each individual task. TASK1: HIGH/PASS/LOW/ERROR TASK2: HIGH/PASS/LOW/ERROR ... TASK7: HIGH/PASS/LOW/ERROR TASK8: HIGH/PASS/LOW/ERROR
Serial communication	Results are output for each individual task.

Note

Either of the following methods can be selected for acquiring output data by serial communication:

- Command response method
- Auto output method (Data is output automatically when trigger measurement ends.)



Communication Method p.151

Using the Controller I/O Cable

By using the Controller's I/O cable, you can output the measurement value or judgment result to external devices, or input a control signal such as zero reset or LD-OFF from external devices. A predetermined I/O signal is assigned to each signal wire of the I/O cable.

Wiring the Controller I/O Cable

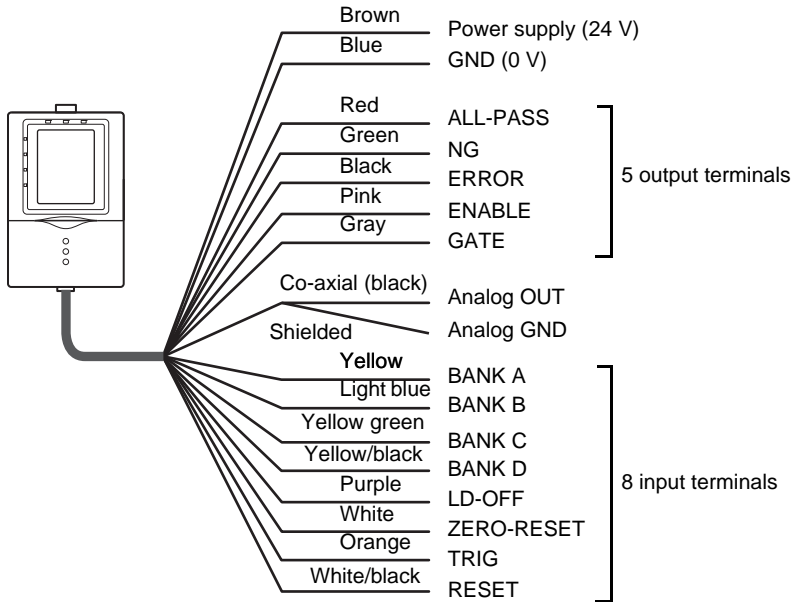

Assignments and Functions of I/O Signal Wires

Assignment of output signal wires

Function	Signal	Description												
Judgment output	ALL-PASS	Turns ON when the judgment result of all tasks is OK (or all tasks are not registered).												
	NG	Turns ON when there is even one task whose judgment result is NG.												
	ERROR	Turns ON when there is even one task for which a measurement error occurred.												
Trigger auxiliary	ENABLE	Turns ON when trigger input is enabled during trigger measurement. Turns OFF during bank switching. <table border="1" data-bbox="453 491 999 580" style="margin: 10px auto;"> <thead> <tr> <th></th> <th>Regular</th> <th>During trigger measurement</th> <th>Bank switching in progress</th> </tr> </thead> <tbody> <tr> <td>Trigger</td> <td>ON</td> <td>OFF</td> <td>OFF</td> </tr> <tr> <td>Continuous</td> <td>ON</td> <td>-</td> <td>OFF</td> </tr> </tbody> </table>		Regular	During trigger measurement	Bank switching in progress	Trigger	ON	OFF	OFF	Continuous	ON	-	OFF
		Regular	During trigger measurement	Bank switching in progress										
Trigger	ON	OFF	OFF											
Continuous	ON	-	OFF											
	GATE	Turns ON when the measurement result is being fixed. (The startup and output times can also be set.)												
Analog output	ANALOGOUT/ ANALOGGND	<p>Connect the analog output wire to an external ammeter or voltmeter, and convert the measurement value for output as 4 to 20 mA analog current or -10 to +10 V analog voltage. With analog output, output values can be scaled or corrected to suit the conditions of the connected external device.</p> <p> Analog Output Settings p.132</p> <p>Note</p> <p>The maximum response in analog output is 500 μs.</p>												

Assignment of input signal wires

Function	Signal	Description																																																																																					
Bank switching	BANK A/ BANK B/ BANK C/ BANK D	This is used for switching banks. Specify the bank No. in combinations of A to D.																																																																																					
		<table border="1"> <thead> <tr> <th>Selected bank</th> <th>BANK A</th> <th>BANK B</th> <th>BANK C</th> <th>BANK D</th> </tr> </thead> <tbody> <tr><td>Bank 1</td><td>0</td><td>0</td><td>0</td><td>0</td></tr> <tr><td>Bank 2</td><td>0</td><td>0</td><td>0</td><td>1</td></tr> <tr><td>Bank 3</td><td>0</td><td>0</td><td>1</td><td>0</td></tr> <tr><td>Bank 4</td><td>0</td><td>0</td><td>1</td><td>1</td></tr> <tr><td>Bank 5</td><td>0</td><td>1</td><td>0</td><td>0</td></tr> <tr><td>Bank 6</td><td>0</td><td>1</td><td>0</td><td>1</td></tr> <tr><td>Bank 7</td><td>0</td><td>1</td><td>1</td><td>0</td></tr> <tr><td>Bank 8</td><td>0</td><td>1</td><td>1</td><td>1</td></tr> <tr><td>Bank 9</td><td>1</td><td>0</td><td>0</td><td>0</td></tr> <tr><td>Bank 10</td><td>1</td><td>0</td><td>0</td><td>1</td></tr> <tr><td>Bank 11</td><td>1</td><td>0</td><td>1</td><td>0</td></tr> <tr><td>Bank 12</td><td>1</td><td>0</td><td>1</td><td>1</td></tr> <tr><td>Bank 13</td><td>1</td><td>1</td><td>0</td><td>0</td></tr> <tr><td>Bank 14</td><td>1</td><td>1</td><td>0</td><td>1</td></tr> <tr><td>Bank 15</td><td>1</td><td>1</td><td>1</td><td>0</td></tr> <tr><td>Bank 16</td><td>1</td><td>1</td><td>1</td><td>1</td></tr> </tbody> </table>	Selected bank	BANK A	BANK B	BANK C	BANK D	Bank 1	0	0	0	0	Bank 2	0	0	0	1	Bank 3	0	0	1	0	Bank 4	0	0	1	1	Bank 5	0	1	0	0	Bank 6	0	1	0	1	Bank 7	0	1	1	0	Bank 8	0	1	1	1	Bank 9	1	0	0	0	Bank 10	1	0	0	1	Bank 11	1	0	1	0	Bank 12	1	0	1	1	Bank 13	1	1	0	0	Bank 14	1	1	0	1	Bank 15	1	1	1	0	Bank 16	1	1	1	1
		Selected bank	BANK A	BANK B	BANK C	BANK D																																																																																	
		Bank 1	0	0	0	0																																																																																	
		Bank 2	0	0	0	1																																																																																	
		Bank 3	0	0	1	0																																																																																	
		Bank 4	0	0	1	1																																																																																	
		Bank 5	0	1	0	0																																																																																	
		Bank 6	0	1	0	1																																																																																	
		Bank 7	0	1	1	0																																																																																	
		Bank 8	0	1	1	1																																																																																	
		Bank 9	1	0	0	0																																																																																	
		Bank 10	1	0	0	1																																																																																	
		Bank 11	1	0	1	0																																																																																	
		Bank 12	1	0	1	1																																																																																	
		Bank 13	1	1	0	0																																																																																	
		Bank 14	1	1	0	1																																																																																	
Bank 15	1	1	1	0																																																																																			
Bank 16	1	1	1	1																																																																																			
(0: OFF, 1: ON)																																																																																							
ENABLE output becomes OFF during bank switching. (when a trigger is enabled)																																																																																							
 Bank switching time p.147																																																																																							
Stop laser	LD-OFF	Stops laser lighting (emission). While LD-OFF is being input, linear output and judgment output conform to the non-measurement setting.																																																																																					
Execute zero reset	ZERO-RESET	Sets the measurement values of all tasks to zero. <ul style="list-style-type: none"> At zero reset execution Input the zero reset signal for 50 to 800 ms. After the zero reset execution signal turns OFF, the zero reset is executed within 1 measurement cycle. At zero reset cancellation Input the zero reset signal for 1s or longer. The zero reset is cancelled within 1 measurement cycle after 1s elapses. 																																																																																					
Measurement trigger	TRIG	Inputs the measurement start timing from an external device when the trigger setting is ON. Inputs the hold execution start/stop timing when a hold is set.																																																																																					
Execute reset	RESET	Clears the measurement results and output. (Measurement results and output are restored to a measurement non-applied state.)																																																																																					

I/O Circuit Diagrams

Important

Make sure that the load connected to the "analog output wire (co-axial) - analog GND wire" satisfies the rating of the set state (voltage or current output) before turning the Controller ON. Otherwise, the Controller may be damaged.

NPN type (ZG2-WDC11)

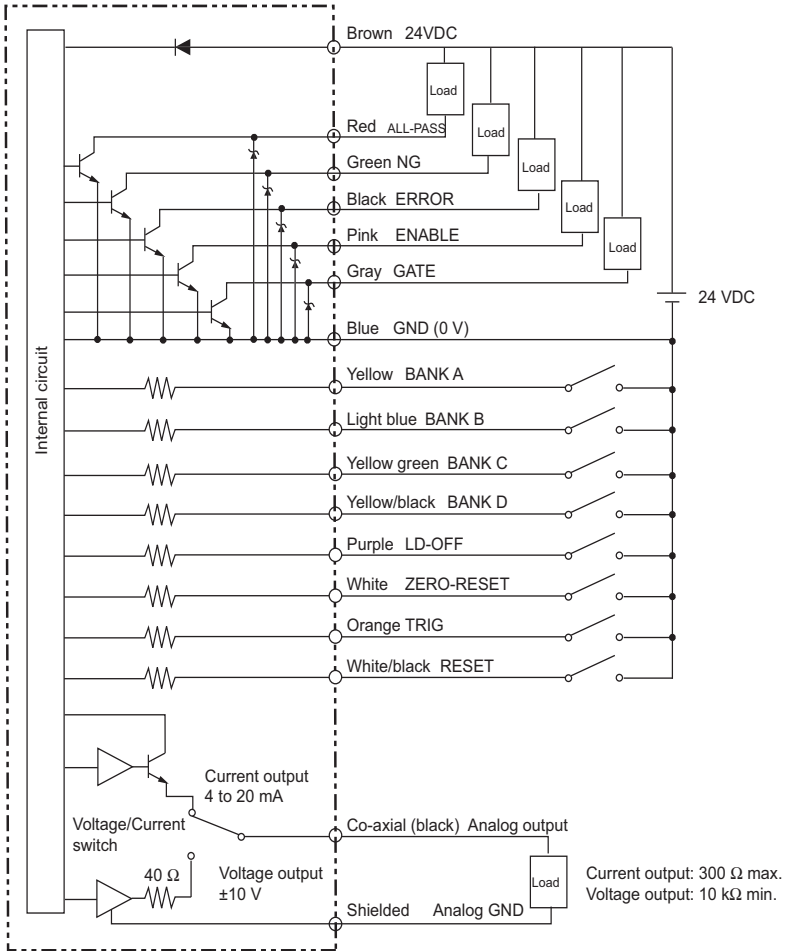

PNP type (ZG2-WDC41)

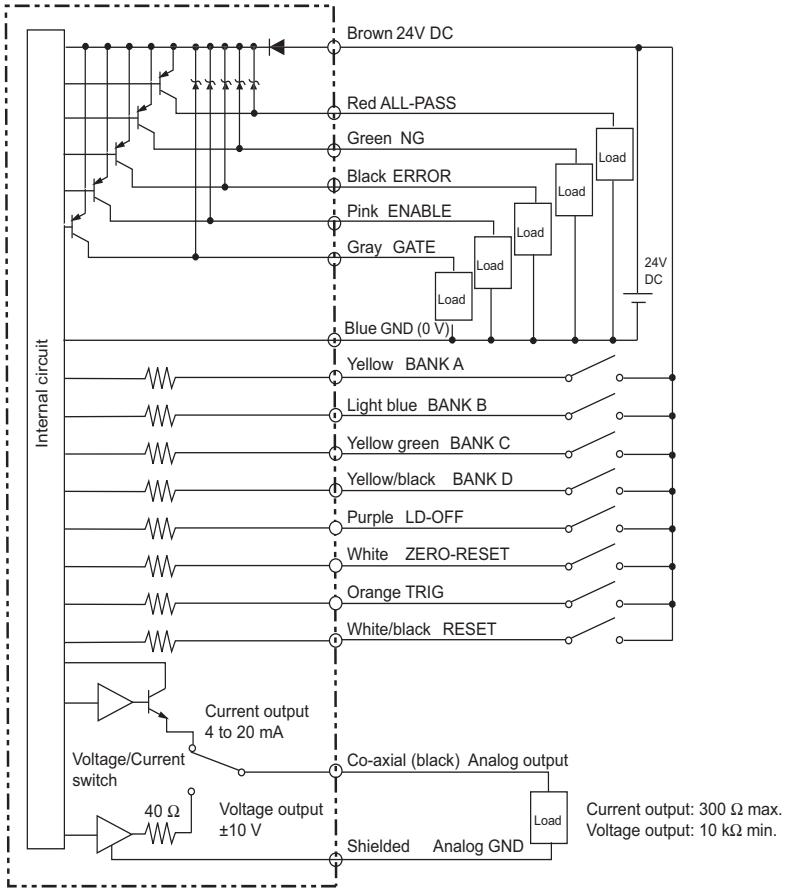

4 CONNECTION WITH EXTERNAL DEVICES

Analog Output Settings

Assignment of Tasks for Analog Output

Set the assignments to the analog output wire. Only 1 task can be assigned for analog output when multiple tasks are set.

► FUN mode-[I/O]-[ANALOG]-[TASK]

Setting value	Description
OFF	Analog output is not performed.
TASK1, TASK2, TASK3, TASK4, TASK5, TASK6, TASK7, TASK8	The measurement value of the task selected here is analog-output from the Controller. (default value: TASK1)

Scaling Analog Output Values

With analog output, the relationship between the displayed measured value and output value can be freely set as the measurement result is converted to a current of 4 to 20 mA or a voltage of -10 to +10 V, and is then output. Match the settings to suit the connected external device. Enter the output values for any 2 current values or voltage values to set the output range. (default value: OFF)

Example: Set 0 mm to 4 mA, and 5 mm to 20 mA. (for current output)

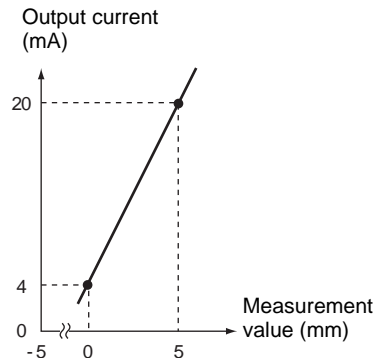
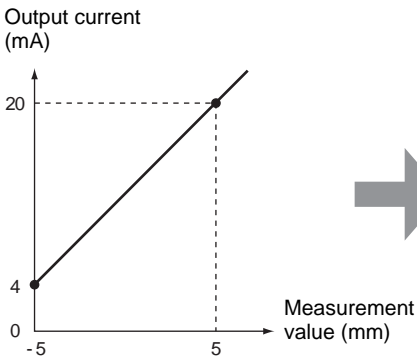

► FUN mode-[I/O]-[ANALOG]-[SCALE]-[ON]

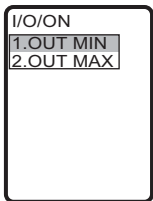
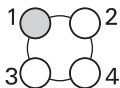

1 Select [OUT MIN].

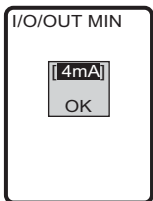

2 Move the cursor to the numerical value by the \uparrow/\downarrow key, and press the SET key.



3 Select the output value of MIN by the \uparrow/\downarrow key, and press the SET key twice.

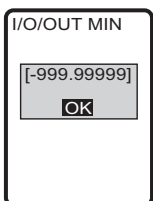
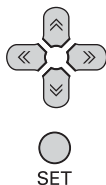

4 Input the measurement value corresponding to OUTPUT MIN, and press the SET key.
Range: -999.99999 to 999.99999

Note

To change numerical values, use the \uparrow key/ \downarrow key, and to change the number of digits use the \leftarrow key/ \rightarrow key.

5 Repeat steps 1 to 4 to set OUTPUT MAX.

Correcting Analog Output Values

Discrepancies may occur between the analog output current (or voltage) values set on the Controller and the actual current (or voltage) values measured due to the conditions for the connected external device or other factors. The analog output correction function can be used to correct this discrepancy. Output values are corrected by entering the correction value for the current (or voltage) values for any 2 points. (default value: OFF)

Range: -999 to 999

Important

Set scaling beforehand, and select current output or voltage output. Also, connect the analog output wire to an external ammeter or voltmeter. The relationship between the preset correction values and the current value or voltage value recognized by the connected external device differs according to each individual external device. Set correction values while checking the current value or voltage value on the external device actually connected to the Controller so that expected values are indicated.

► FUN mode-[I/O]-[ANALOG]-[ADJUST]-[ON]



SET

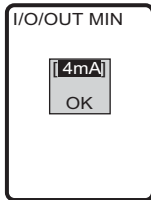

1

Move the cursor to the numerical value by the \uparrow/\downarrow key, and press the SET key.



SET

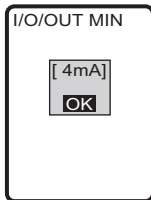

2

Select the output value of MIN by the \uparrow/\downarrow key and press the SET key twice.

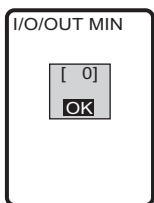
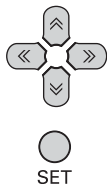

- 3** Input the correction value corresponding to **OUTPUT MIN**, and press the **SET** key.

Note

To change numerical values, use the ↑ key/↓ key, and to change the number of digits use the ← key/→ key.

- 4** Repeat steps 1 to 3 to set **OUTPUT MAX**.

Analog Output Values at Measurement Failure

Set the output methods for when a non-measurement state occurs temporarily, for example, due to insufficient received light amount or the reset input status.

► ADJ mode-MENU/VIEW key-[OUT]-[ERROR]-[ERROR]

Setting value	Description
KEEP	The status immediately before measurement is stopped is held and output.
CLAMP	The preset clamp value (abnormal value) is output. (default value)

When [CLAMP] is selected, set the clamp value.

► FUN mode-[I/O]-[ANALOG]-[CLAMP]

Setting value
At current output: MIN (approx.2 mA), MAX (approx.25 mA, default value), 4 to 20 mA (in 1 mA increments)
At voltage output: MIN (approx.-11 V), MAX (approx.11 V, default value), -10 to 10 V (in 1 V increments)

Setting for Measurement by the TRIG Signal

Set the measurement timing method.

The default setting is [DISABLE] (continuous measurement).

► FUN mode-[I/O]-[I/O LINE]-[TRIGGER]

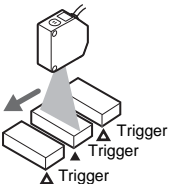
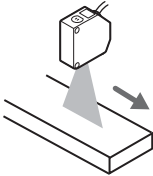
Setting value	Description
ENABLE	Measurement is performed synchronized to the trigger signal that is input from the external device. 
DISABLE	The trigger is not used and measurement is performed continuously. (default value) 

Setting for Switching Banks by the BANK Signal

Set from where switching of banks is to be instructed.

► FUN mode-[I/O]-[I/O LINE]-[BANK]

Setting value	Description
MENU	Bank switching is performed by operating the control keys. (default value)
EXT IN	Bank switching is performed from the external input wire.

Checking Signal Statuses

The status of I/O signals can be monitored to check the normality of wiring and communication settings. Output signals can be toggled ON/OFF by setting 0/1. The status of input from external devices is reflected as 0 (OFF)/1 (ON) of input signals.

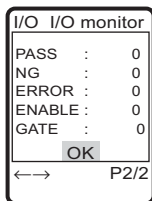
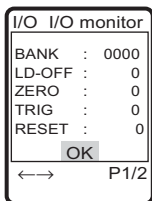

Note

In the case of output signals move between setting items by the \uparrow/\downarrow key, and press the SET key for each setting item to toggle between 0/1.

► FUN mode-[I/O]-[IOMON]

Setting the GATE Signal

Setting the GATE period

Set the period that the GATE signal remains ON. Set a value that allows the external device to capture the measurement result. Output on the ZG-RPD□1 conforms to the timing set here.

► FUN mode-[I/O]-[I/O LINE]-[GATE PERIOD]

Setting value	Description
1 to 500 (ms)	Set the period that the GATE signal remains ON. (default value: 3 ms)

Setting the GATE delay

Sets the time delay from when the result is output to the terminal block to when the GATE signal is turned ON. Output on the ZG-RPD□1 conforms to the timing set here.

► FUN mode-[I/O]-[I/O LINE]-[GATE DELAY]

Setting value	Description
1 to 50 (ms)	Sets the time delay from when the result is output to the terminal block to when the GATE signal is turned ON. (default value: 1 ms)

Using the Parallel Output Unit (sold separately)

The Parallel Output Unit (ZG-RPD□1) (sold separately) can be used to output measurement values or judgment results to external devices at high speed.

Measurement values are converted to 16-bit binary data before they are output.

Connecting the Parallel Output Unit

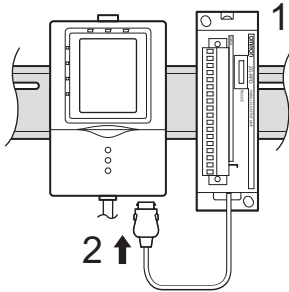

- 1** Mount the Parallel Output Unit on a DIN track.
- 2** Connect the connector to the RS-232C connector on the ZG2-WDC.

Layout of Output Terminals

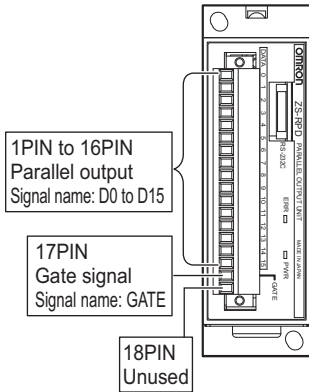

Pin No.	Signal name	Bit assignment	Description
1	D0	b0	Binary data output pin
2	D1	b1	
3	D2	b2	
4	D3	b3	
5	D4	b4	
6	D5	b5	
7	D6	b6	
8	D7	b7	
9	D8	b8	
10	D9	b9	
11	D10	b10	
12	D11	b11	
13	D12	b12	
14	D13	b13	
15	D14	b14	
16	D15	b15	
17	GATE	-	GATE si
18	-	-	Unused

Output Circuit

The following circuit configuration is employed for the total of 17 outputs (data outputs D0 to D15 and GATE signal).

NPN output type (ZG-RPD11)

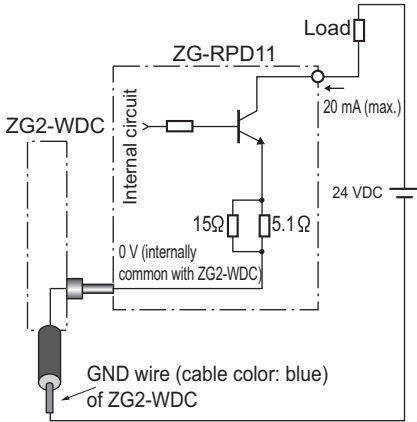

PNP output type (ZG-RPD41)

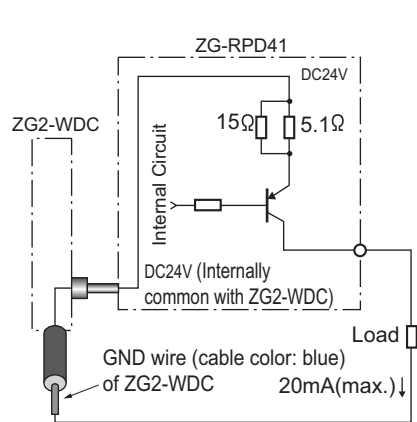

Output Format of Measurement Values

Measurement values are handled as integers matched to the number of digits past the decimal point setting, and are converted to a 16-bit binary number (2's complement) before they are output. Bit expressions are output using minus logic ("1" when open output is ON).

<Output Format>

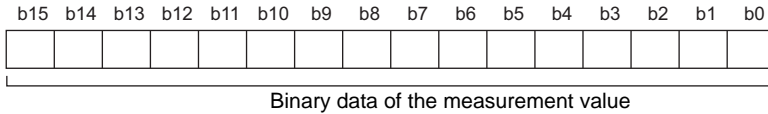

<Output of Measurement Values (example)>

The following shows an example where the number of digits past the decimal point is set to "3".

Output of measurement standby status

b15	b14	b13	b12	b11	b10	b9	b8	b7	b6	b5	b4	b3	b2	b1	b0
0	0	0	0	0	0	0	0	0	0	0	0	0	0	0	0

Output at "no measurement target present" error

b15	b14	b13	b12	b11	b10	b9	b8	b7	b6	b5	b4	b3	b2	b1	b0
1	1	1	1	1	1	1	1	1	1	1	1	1	1	1	1

When measurement value is "+1.234"

b15	b14	b13	b12	b11	b10	b9	b8	b7	b6	b5	b4	b3	b2	b1	b0
0	0	0	0	0	1	0	0	1	1	0	1	0	0	1	0

When measurement value is "-1.234"

b15	b14	b13	b12	b11	b10	b9	b8	b7	b6	b5	b4	b3	b2	b1	b0
1	1	1	1	1	0	1	1	0	0	1	0	1	1	1	0

Output Format of Judgment Results

The measurement result and measurement status of each task are output as binary data.

<Output Format>

When [4TASK] is set:

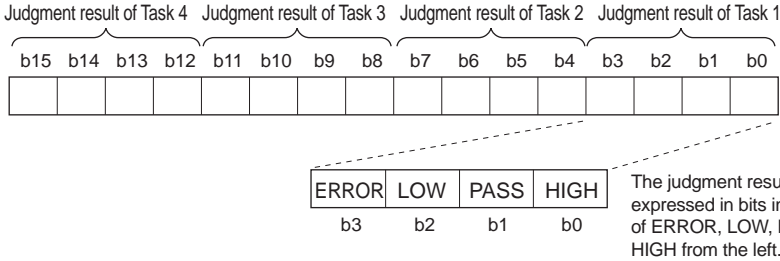

Signal name	Bit	Function	Item	Description
D0	b0	Task 1 judgment output	HIGH	Turns ON when the judgment result of task 1 is HIGH.
D1	b1		PASS	Turns ON when the judgment result of task 1 is PASS.
D2	b2		LOW	Turns ON when the judgment result of task 1 is LOW.
D3	b3		ERROR	Turns ON when the judgment result of task 1 is an error.
D4	b4	Task 2 judgment output	HIGH	Turns ON when the judgment result of task 2 is HIGH.
D5	b5		PASS	Turns ON when the judgment result of task 2 is PASS.
D6	b6		LOW	Turns ON when the judgment result of task 2 is LOW.
D7	b7		ERROR	Turns ON when the judgment result of task 2 is an error.
D8	b8	Task 3 judgment output	HIGH	Turns ON when the judgment result of task 3 is HIGH.
D9	b9		PASS	Turns ON when the judgment result of task 3 is PASS.
D10	b10		LOW	Turns ON when the judgment result of task 3 is LOW.
D11	b11		ERROR	Turns ON when the judgment result of task 3 is an error.
D12	b12	Task 4 judgment output	HIGH	Turns ON when the judgment result of task 4 is HIGH.
D13	b13		PASS	Turns ON when the judgment result of task 4 is PASS.
D14	b14		LOW	Turns ON when the judgment result of task 4 is LOW.
D15	b15		ERROR	Turns ON when the judgment result of task 4 is an error.

When [8TASK] is set:

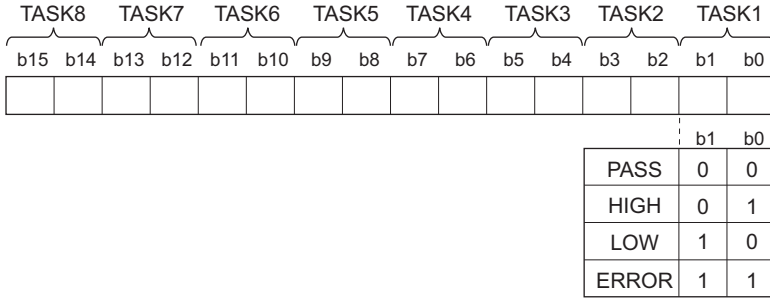

Signal name	Bit	Description
D0	b0	The judgment result of TASK1 is output.
D1	b1	
D2	b2	The judgment result of TASK2 is output.
D3	b3	
D4	b4	The judgment result of TASK3 is output.
D5	b5	
D6	b6	The judgment result of TASK4 is output.
D7	b7	
D8	b8	The judgment result of TASK5 is output.
D9	b9	
D10	b10	The judgment result of TASK6 is output.
D11	b11	
D12	b12	The judgment result of TASK7 is output.
D13	b13	
D14	b14	The judgment result of TASK8 is output.
D15	b15	

Assignment of Terminal Block Output

Set the output content for the Real-time Parallel Output Unit.

► FUN mode-[I/O]-[RPD]-[OUTPUT]

Setting value	Description
OFF	Does not output to the Real-time Parallel Output Unit.
MEAS (measurement value)	Outputs the measurement value to the Real-time Parallel Output Unit. Select one task to output. (default value)
JUDGE (judgment value)	Outputs the judgment result to the Real-time Parallel Output Unit. When multiple tasks are set, the respective judgment result for all tasks is output. The maximum number of tasks that can be set at once is four tasks. When the number of setup tasks is four or less, select [4TASK]. When the number of setup tasks is five to eight, select [8TASK].

Setting the Number of Digits Past the Decimal Point

Set the number of digits past the decimal point of the measurement value to output to the Real-time Parallel Output Unit.

► FUN mode-[I/O]-[RPD]-[DIGIT]

Setting value	Description
5, 4, 3, 2, 1	Sets the number of output digits past the decimal point. (default value: 3)

Setting GATE Signal at Parallel Output

Setting the GATE period

 Setting the GATE Signal p.137

Setting the GATE delay

 Setting the GATE Signal p.137

I/O Timing Charts

This section explains the I/O signals that are exchanged between the Controller and external devices, and the timing charts for data output.

External output at trigger measurement (MULTI sensitivity/HS MULTI sensitivity/FIXED sensitivity)

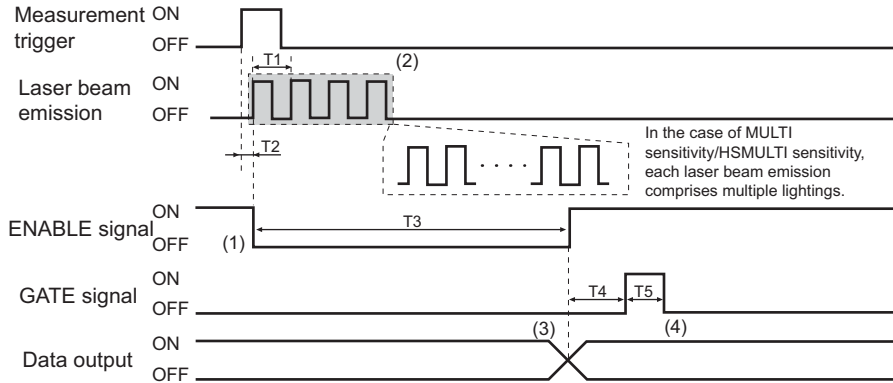

T1: measurement cycle	The measurement cycle can be checked by the ECO monitor in the RUN mode.  p.67
T2: Trigger input response time	This is the time from input of the measurement trigger up to when input is recognized as the trigger. 500 μs or less
T3: Output response time	When the trigger is detected after it is input, data output changes status from ON to OFF, and this status is held for the following preset time. At FIXED sensitivity: $T3 = T1 \times (\text{average number of times} + 2)$ (maximum value) At MULTI sensitivity: $T3 = T1 \times \text{average number of times}$
T4: GATE output delay time	This is the time from start of output up to when the GATE signal turns ON. This time can be changed. This is the time to wait until stable output data can be obtained.
T5: GATE ON time	This is the time that the GATE signal is ON. This time can be changed. This is the time that is required to capture data output (measurement values/judgment results) on external devices.

Important

- When the auto output for serial output is ON, input the next trigger after all measurement data is received. At this time, the ENABLE signal turns ON after all measurement data has finished being sent.
- The GATE signal is output from both the Controller and Parallel Output Unit. For details of signals output directly from the Controller and signals output from the Parallel Output Unit, see the description for GATE signal on the Controller and GATE signal on the Parallel Output Unit, respectively.

Explanation of Operation

- (1) When the measurement trigger signal is input, the ENABLE signal turns OFF after the trigger input response time elapses.
- (2) Measurement is executed for the preset average number of times. (In the example, the average number of times is set to 4.)
- (3) When measurement ends, the applied measurement data is output after the output response time elapses. When the ENABLE signal changes status to ON, the next trigger can be accepted.
- (4) When the GATE output delay time elapses after start of output, the GATE signal turns ON for the specified time, and measurement data is captured on the external device.

External output at trigger measurement (AUTO sensitivity)

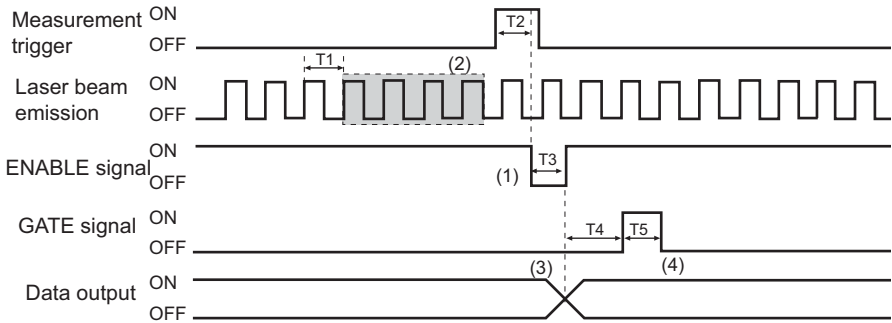

T1: measurement cycle	The measurement cycle can be checked by the ECO monitor in the RUN mode.  p.67
T2: Trigger input response time	This is the time from input of the measurement trigger up to when input is recognized as the trigger. 500 μ s or less

T3: Output response time	When the trigger is detected after it is input, data output changes status from ON to OFF, and this status is held for the "measurement cycle (T1) × 2 or less."
T4: GATE output delay time	This is the time from start of output up to when the GATE signal turns ON. This time can be changed. This is the time to wait until stable output data can be obtained.
T5: GATE ON time	This is the time that the GATE signal is ON. This time can be changed. This is the time that is required to capture data output (measurement values/judgment results) on external devices.

Important

- When the auto output for serial output is ON, input the next trigger after all measurement data is received. At this time, the ENABLE signal turns ON after all measurement data has finished being sent.
- The GATE signal is output from both the Controller and Parallel Output Unit. For details of signals output directly from the Controller and signals output from the Parallel Output Unit, see the description for GATE signal on the Controller and GATE signal on the Parallel Output Unit, respectively.

Explanation of Operation

- (1) When the measurement trigger signal is input, the ENABLE signal turns OFF after the trigger input response time elapses.
- (2) The average value is output from the past N number of results (preset average number of times). (In the example, the average number of times is set to 4.)
- (3) After the output response time elapses, the applied measurement data is output. When the ENABLE signal changes status to ON, the next trigger can be accepted.
- (4) When the GATE output delay time elapses after start of output, the GATE signal turns ON for the specified time, and measurement data is captured on the external device.

External output during continuous measurement (trigger disabled)

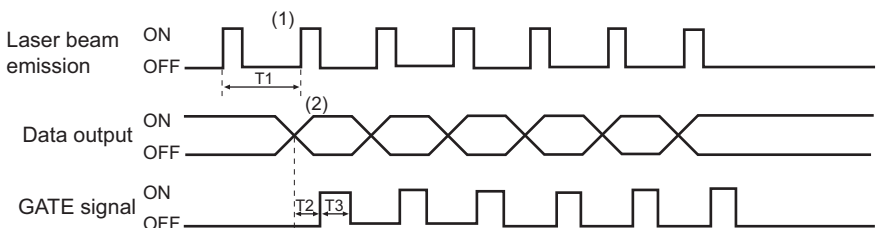

Important

- Serial output is not possible even if AUTO is set to ON.
- The ENABLE signal is ON at all times.
- During output of the GATE signal, the next GATE signal is not output and is ignored.
- The GATE signal is output from both the Controller and Parallel Output Unit. For details of signals output directly from the Controller and signals output from the Parallel Output Unit, see the description for GATE signal on the Controller and GATE signal on the Parallel Output Unit, respectively.

T1: Measurement cycle	The measurement cycle differs according to the set content. The measurement cycle can be checked by the ECO monitor.  p.67
T2: GATE output delay time	This is the time from start of output up to when the GATE signal turns ON. This time can be changed. This is the time to wait until stable output data can be obtained.
T3: GATE ON time	This is the time that the GATE signal is ON. This time can be changed. This is the time that is required to capture data output (measurement values/judgment results/profiles) on external devices.

Explanation of Operation

- (1) Measurement is executed at each individual measurement cycle.
- (2) Measurement data is output when the measurement values are applied after measurement is started.

External input of bank switching signal

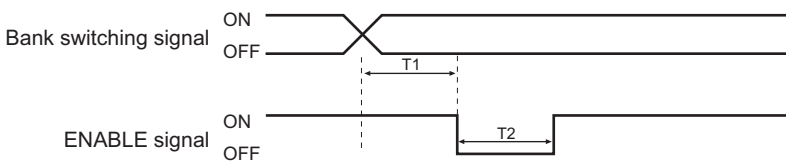

T1: ENABLE signal OFF response time	This is the time after input of the bank switching signal until the ENABLE signal turns OFF. When the ECO monitor (display OFF) is operating: 20 ms or less When the digital monitor is operating: 300 ms or less When the profile monitor is operating: 200 ms or less
T2: Bank switching time	This is the time in which bank switching is executed. When the ECO monitor (display OFF) is operating: 200 ms or less When the digital monitor is operating: 500 ms or less When the profile monitor is operating: 400 ms or less

External input of laser stop signal

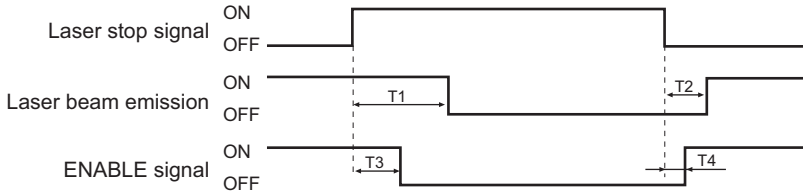

T1: Laser stop response time	This is the time after the laser stop signal is input until laser emission is stopped. 30 ms or less
T2: Laser restore response time	This is the time after the laser stop signal is canceled until laser emission is started. 20 ms or less
T3: ENABLE signal OFF response time	This is the time after input of the laser stop signal until the ENABLE signal turns ON. 10 ms or less
T4: ENABLE signal ON response time	This is the time after cancellation of the laser stop signal until the ENABLE signal turns ON. 5 ms or less

Serial Communication

Using the Serial Interface

You can use the USB port or RS-232C connector of the Controller to perform serial communication with external devices such as a personal computer or programmable controller. By serial communication, you can obtain higher resolution and more stable measurement data than with analog output.

Serial communication functions in the RUN mode. Communication cannot be performed in the FUN or ADJ modes. Also, when a system error occurs, the Controller accepts external commands, but does not execute the preset command.

Important

During RS-232C communication, measurement operations are stopped.

Communication Interface Specifications

<USB>

This interface allows full-speed (12 Mbps) communications compliant with USB 2.0 with a PC equipped with the same USB interface as standard.

Communication method	Full duplex
Synchronization method	Start-stop
Transmission code	ASCII (Binary format can be selected only for profile output.)
Data length	-
Parity	-
Stop bit	-
Baud rate	-
Delimiter	CR, LF, CR+LF

<RS-232C>

This interface allows data communications compliant with the EIA RS-232C standard up to a maximum speed of 115200 bps.

Communication method	Full duplex
Synchronization method	Start-stop
Transmission code	ASCII (Binary format can be selected only for profile output.)
Data length	8 bits, 7 bits
Parity	None, odd, even
Stop bit	1 bit, 2 bits
Baud rate	9600, 19200, 38400, 57600, 115200
Delimiter	CR, LF, CR+LF



For details on communication specification settings, see "Setting the RS-232C Communication Specifications (p.156)."

Communication Method

For serial interface-based communications, two communication methods are used; "command response method" and "auto output method." The communication method can be set and switched on the Controller.

 Serial Auto Output at Trigger Measurement p.155

Command response method

By this method, command processing is executed when a command is sent to the Controller from an external device, and a response is returned to the external device from the Controller, when command processing ends. An error response is returned when the command sent from the external device is in error or when an error occurs during command processing on the Controller.

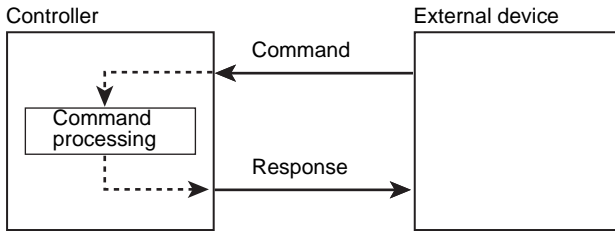

Auto output method

By this method, measurement value data is automatically output to the connected external device when the measurement values are applied after the input trigger is detected. An error response is returned when error detection is erroneous or when an error occurs during command processing on the Controller. Auto output is supported only on the USB interface.

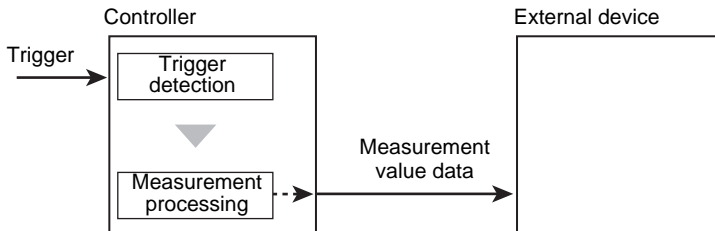

Note

- Automatic output on the serial interface is not available in continuous measurement. (Commands only are supported.)
- Before connecting the personal computer to the Controller, start up the terminal software for acquiring measurement values.

Connecting Peripheral and External Devices

Connecting a PC

Use the USB/RS-232C cable to connect the PC to the Controller.

Important

When connecting devices, refer to the Instruction Manual for the PC.

Connecting by a USB cable

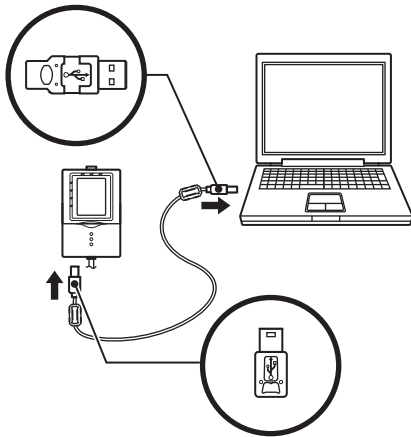

Use the USB cable provided with the ZG2-WDC□1A Controller to connect the Controller to the PC.

Important

Attach the ferrite cores (supplied) to both ends of the USB cable.

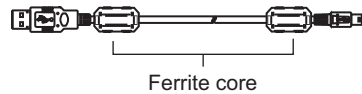

Note

Installation of the USB driver is necessary only when connecting an external device to the USB interface for the first time. For the USB driver, use the exclusive USB driver packaged with the ZG2-WDC□1A controller. Smart Monitor ZG2 is an accessory of the ZG2-WDC□1A.

Connecting by an RS-232C cable

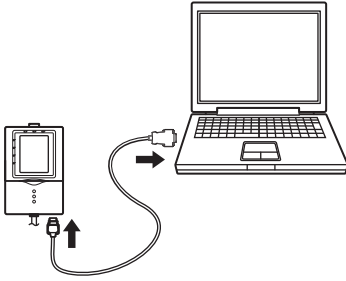

Use the exclusive cable to connect the Controller to the PC.

RS-232C cable for connecting a personal computer

Use a cable with the following pin layout.

ZS-XRS2 (cable length: 2 m)

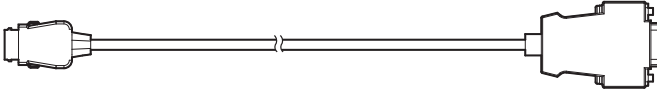

Controller side

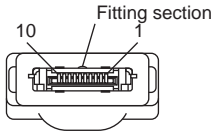

Personal computer side (PC/AT compatible)

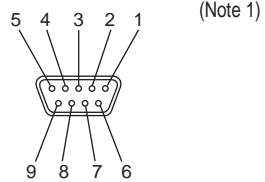

Signal name	Pin No.
NC	1
SD (TXD)	2
RD (RXD)	3
RS (RTS)	4
CS (CTS)	5
NC	6
NC	7
NC	8
SG (GND)	9
NC	10
FG	Shell

Pin No.	Signal name
1	NC
2	RD (RXD)
3	SD (TXD)
4	NC
5	SG (GND)
6	NC
7	RS (RTS)
8	CS (CTS)
9	NC
Shell	FG

Note 1: Socket type connector

Connecting to a PLC

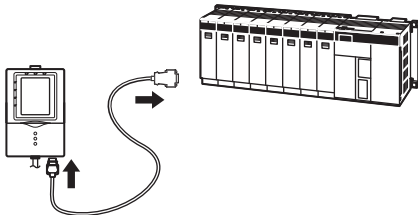

Use the RS-232C cable to connect the PC to a PLC.

Important

When connecting to a PLC, refer to the Instruction Manual for the PLC.

RS-232C cable for connecting a PLC

Use a cable with the following pin layout.

ZS-XPT2 (cable length: 2 m)

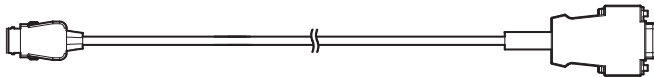

Controller side

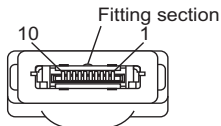

PT/PLC side (Note 1)

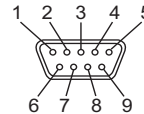

Signal name	Pin No.
NC	1
SD (TXD)	2
RD (RXD)	3
RS (RTS)	4
CS (CTS)	5
NC	6
NC	7
NC	8
SG (GND)	9
NC	10
FG	Shell

Pin No.	Signal name
1	NC
2	SD (TXD)
3	RD (RXD)
4	RS (RTS)
5	CS (CTS)
6	NC
7	NC
8	NC
9	SG (GND)
Shell	FG

Note 1: Plug type connector

Serial Auto Output at Trigger Measurement

Set whether or not to perform serial output at trigger measurement.

 Communication Method p.151

► FUN mode-[I/O]-[SERIAL]-[AUTO]

Setting value	Description
OFF	Sets the command response method for serial output. Measurement data is output only when a data acquisition command is input from an external device. (default value)
ON	Sets the auto output method for serial output. The measurement data is output when measurement ends. (MEASURE or other commands are not required.)



Important

With auto output, output on the USB interface only is enabled.

Setting Automatic Output

This function is enabled only when the auto output method is set for serial output. When [OFF] is set, specify the desired task to output as the parameter when the MEASURE command is input.

► FUN mode-[I/O]-[SERIAL]-[OUTPUT]

Setting value	Description
TASK1, TASK2, TASK3, TASK4, TASK5, TASK6, TASK7, TASK8	The measurement value of the task selected here is serial-output. (default value: TASK1) The output format is the same as that of the MEASURE command.  p.162
TASKALL	All tasks 1 to 8 are output. The output format is the same as that of the MEASURE command.  p.162

Setting value	Description
PROFILE (A), PROFILE (B)	<p>The profile is output.</p> <p>The output format is the same as that of the PROFILE command. When profile (A) is selected, the profile is output in PROFILE 0 (ASCII format). When profile (B) is selected, the profile is output in PROFILE 1 (binary format).</p> <p>Auto output of profiles is not possible in the case of AUTO sensitivity.</p> <p> p.173</p>

Setting the RS-232C Communication Specifications

Set the communication specifications for the Controller matched to the communication specifications of external devices.

► FUN mode-[SYSTEM]-[RS-232C]

Setting value	Description
LENGTH	8BIT, 7BIT (default value: 8BIT)
PARITY	NONE, ODD, EVEN (default value: NONE)
STOP (stop bit)	1BIT, 2BIT (default value: 1BIT)
BAUDRATE	9600, 19200, 38400, 57600, 115200 (default value:38400)
DELIMIT	CR, LF, CR+LF (default: CR)

Setting the Node No.

This node No. sets the connection group No. as seen from the host device (PLC). Not only the ZG2 series but also multiple devices can be connected to the PLC. The No. assigned to devices connected to a PLC in this instance is referred to as a node No..

► FUN mode-[SYSTEM]-[NODE]

Setting value	Description
0 to 16	This node No. sets the connection group No. as seen from the PLC. (default value: 0)

About Communication Commands

Command/Response Format

<Command>

Command data	Delimiter
--------------	-----------

<Response>

When processing ends successfully

Response data	Delimiter
---------------	-----------

O	K	Delimiter
---	---	-----------

When processing fails

E	R	Delimiter
---	---	-----------

Command data	Specifies the command and parameters.
Response data	Stores the acquired data.
Delimiter	This control code indicates the end of the data.

Configuration of measurement value data

Acquired measurement values are output as a data structure of variable length of up to 12 characters (when the number of digits past the decimal point is set to 5) including delimiters and sign.

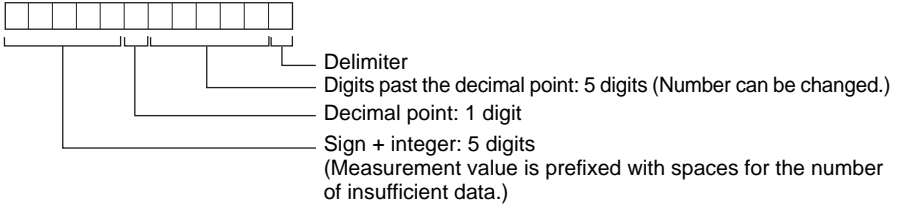

Sign	The sign (+, -) of the measurement value is stored.																																							
Integer	When the integer section of the measurement value is less than 3 characters, it is prefixed with spaces for the number of insufficient data.																																							
Decimal point	When the number of digits past the decimal point is reduced, the length of the text string decreases proportionately.																																							
Digits past the decimal point	<p> Setting the Number of Digits Past the Decimal Point p.122</p> <p><Measurement value> <Data configuration></p> <p>+12.34567 <table border="1" style="display: inline-table; vertical-align: middle;"><tr><td> </td><td> </td><td>+</td><td>1</td><td>2</td><td>.</td><td>3</td><td>4</td><td>5</td><td>6</td><td>7</td><td>C_R</td></tr></table> Number of digits past the decimal point: 5</p> <p>+12.34567 <table border="1" style="display: inline-table; vertical-align: middle;"><tr><td> </td><td> </td><td>+</td><td>1</td><td>2</td><td>.</td><td>3</td><td>C_R</td></tr></table> Number of digits past the decimal point: 1</p> <p>-0.00123 <table border="1" style="display: inline-table; vertical-align: middle;"><tr><td> </td><td> </td><td>-</td><td>0</td><td>.</td><td>0</td><td>0</td><td>1</td><td>C_R</td></tr></table> Number of digits past the decimal point: 3</p> <p>At measurement error <table border="1" style="display: inline-table; vertical-align: middle;"><tr><td> </td><td>-</td><td>9</td><td>9</td><td>.</td><td>9</td><td>9</td><td>9</td><td>9</td><td>C_R</td></tr></table></p>			+	1	2	.	3	4	5	6	7	C _R			+	1	2	.	3	C _R			-	0	.	0	0	1	C _R		-	9	9	.	9	9	9	9	C _R
		+	1	2	.	3	4	5	6	7	C _R																													
		+	1	2	.	3	C _R																																	
		-	0	.	0	0	1	C _R																																
	-	9	9	.	9	9	9	9	C _R																															

Available Commands

Bank control commands

Command name	Description	Reference
BANKSET	Switches the current bank.	p.160
BANKGET	Acquires the current bank No.	p.161

Measurement control/measurement value acquisition commands

Command name	Description	Reference
MEASURE (or M)	Acquires the current measurement value. In the trigger measurement mode, measurement is executed and the measurement value is acquired.	p.162
TRIG (or T)	Issues the measurement trigger.	p.163
ZERORST	Executes a zero reset.	p.164
ZEROCLR	Cancels a zero reset.	p.164

Setting acquisition/change commands

Command name	Description	Reference
DATAGET	Acquires the Controller's bank data. The latest judgment result also can be acquired by this command.	p.165
DATASET	Sets the bank data.	p.165
DATASAVE	Saves all bank data to the Controller's flash memory.	p.166
DATAINIT	Returns all Controller setup data (bank data and system data) to their defaults.	p.166
CHGET	Acquires the number of gang-mounted Controllers and Data Storage Units.	p.167

Backup/restore commands

Command name	Description	Reference
BANKLOAD	Sends the bank data to the Controller by XMODEM protocol.	p.168
BANKSAVE	Receives the bank data from the Controller by XMODEM protocol.	p.169
SYSLOAD	Sends the system data to the Controller by XMODEM protocol.	p.170
SYSSAVE	Receives the system data from the Controller by XMODEM protocol.	p.171

Utility commands

Command name	Description	Reference
CHGDISP	Changes the measurement status monitor. f	p.172
PROFILE (or P)	Acquires the profile.	p.173
VERGET	Acquires the version information of the Controller.	p.174
SEARCH	Automatically sets the sensitivity adjustment ranges of MULTI sensitivity/HS MULTI sensitivity matched to the measurement target.	p.175

Bank Control Commands

Switch Bank <BANKSET command>

This command switches the current bank.

<Command format>

BANKSET CR

Bank No.

<Response format>

When processing ends successfully

OK CR

When processing fails

ER CR

<Explanation of parameters>

Bank No.	Specifies the bank No. after the bank is switched. (1 to 16)
----------	--

Acquire Bank No. <BANKGET command>

This command acquires the current bank No.

<Command format>

BANKGET_{CR}

<Response format>

When processing ends successfully

		CR
--	--	----

└──┬──┘
Bank No.

When processing fails

ER_{CR}

<Explanation of parameters>

Bank No.	The acquired bank No. is returned. (1 to 16)
----------	--

Measurement Control/Measurement Value Acquisition Commands

Acquire Measurement Value <MEASURE command>

This command acquires the current measurement value.

<Command format>

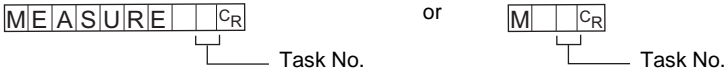

<Response format>

When processing ends successfully

- When tasks 1 to 8 are specified individually

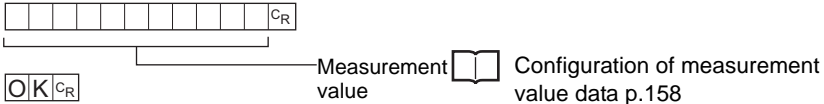

- When all tasks are specified

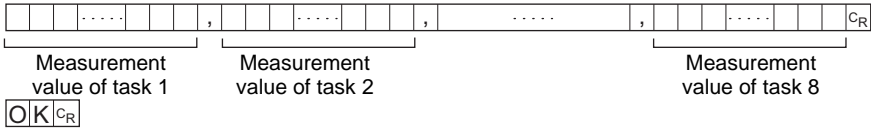

When a measurement error occurs

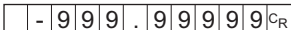

When processing fails



<Explanation of parameters>

Task No.	Specifies the task No. (1 to 8) "0" specifies all tasks. The default value is task 1.
Measurement value	The acquired measurement value is returned.

Issue Measurement Trigger <TRIG command>

This command issues the measurement trigger. No parameters are provided for this command.

<Command format>

TRIG^{C_R} or T^{C_R}

<Response format>

When processing ends successfully (measurement is completed)

OK^{C_R}

When processing fails

ER^{C_R}

Note

After measurement is completed, acquire measurement values by the MEASURE command.

Important

This command functions only when trigger measurement is enabled. It cannot be used in the case of AUTO sensitivity. (If it is executed, ER is returned.)

Execute a Zero Reset <ZERORST command>

This command executes a zero reset on all tasks.

<Command format>

Z E R O R S T ^CR

<Response format>

When processing ends successfully

O K ^CR

When processing fails

E R ^CR

Cancel a Zero Reset <ZEROCLR command>

This command cancels the zero reset on all tasks.

<Command format>

Z E R O C L R ^CR

<Response format>

When processing ends successfully

O K ^CR

When processing fails

E R ^CR

Setting Acquisition/Change Commands

Acquire Bank Data <DATAGET command>

This command acquires the Controller's bank data.

<Command format>

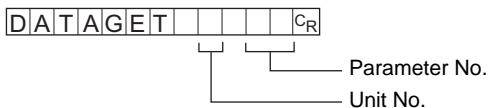

<Response format>

When processing ends successfully

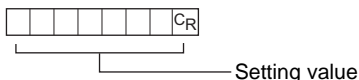

When processing fails

ER_{C_R}



For details on parameters, see "Parameter List (p.176)."

Set Bank Data <DATASET command>

This command sets the bank data.

<Command format>

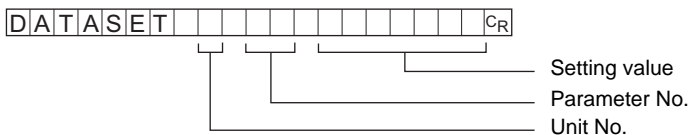

<Response format>

When processing ends successfully

OK_{C_R}

When processing fails

ER_{C_R}



For details on parameters, see "Parameter List (p.176)."

Save All Bank Data <DATASAVE command>

This command saves all bank data to the Controller's flash memory. No parameters are provided for this command.

<Command format>

```
D A T A S A V E CR
```

<Response format>

When processing ends successfully

```
O K CR
```

When processing fails

```
E R CR
```

Initialize Controller <DATAINIT command>

This command returns all Controller setup data (bank data and system data) to their defaults. No parameters are provided for this command.

<Command format>

```
D A T A I N I T CR
```

<Response format>

When processing ends successfully

```
O K CR
```

When processing fails

```
E R CR
```

Acquire Number of gang-mounted Controllers and Data Storage Units <CHGET command>

This command acquires the number of gang-mounted Controllers and Data Storage Units.

<Command format>

```
CHGET  CR
```

Parameter No.

<Response format>

When processing ends successfully

```
OK CR
```

Number

When processing fails

```
ER CR
```

<Explanation of parameters>

Parameter No.	0 (default): Total number is acquired. 1: Number of connected Controllers is acquired. 2: Number of connected Data Storage Units is acquired.
---------------	---

Number

Configuration	Parameter No.		
	0	1	2
ZG2-DSU+ZG2-WDC+ZG2-WDC	3	2	1
ZG2-DSU+ZG2-WDC	2	1	1
ZG2-WDC+ZG2-WDC	2	2	0
ZG2-WDC	1	1	0

Backup/Restore Commands

Send Bank Data <BANKLOAD command>

This command sends the bank data to the Controller by XMODEM protocol. The data is loaded to the currently displayed bank. No parameters are provided for this command.

<Command format>

```
B|A|N|K|L|O|A|D|C|R
```

<File transfer>

The file is transferred by XMODEM (-CRC or -SUM) after READY is received. XMODEM (-K) is not supported.

<Response format>

```
R|E|A|D|Y|C|R
```

When processing ends successfully

```
O|K|C|R
```

When processing fails

```
E|R|C|R
```

Receive Bank Data <BANKSAVE command>

This command receives the bank data from the Controller by XMODEM protocol.

<Command format>

BANKSAVE CR
└──────────┘
Bank No.

<File transfer>

The file is transferred by XMODEM (-CRC or -SUM) after READY is received. XMODEM (-K) is not supported.

<Response format>

READY CR

When processing ends successfully

OK CR

When processing fails

ER CR

<Explanation of parameters>

Bank No.	Specifies the bank No. to receive (acquire) data at. (1 to 16)
----------	--

Send System Data <SYSLOAD command>

This command sends the system data to the Controller by XMODEM protocol. No parameters are provided for this command.

<Command format>

```
S Y S L O A D C R
```

<File transfer>

The file is transferred by XMODEM (-CRC or -SUM) after READY is received. XMODEM (-K) is not supported.

<Response format>

```
R E A D Y C R
```

When processing ends successfully

```
O K C R
```

When processing fails

```
E R C R
```

Receive System Data <SYSSAVE command>

This command receives the system data from the Controller by XMODEM protocol. No parameters are provided for this command.

<Command format>

```
S Y S S A V E C R
```

<File transfer>

The file is transferred by XMODEM (-CRC or -SUM) after READY is received. XMODEM (-K) is not supported.

<Response format>

```
R E A D Y C R
```

When processing ends successfully

```
O K C R
```

When processing fails

```
E R C R
```

Utility commands

Switch the Measurement Status Monitor <CHGDISP command>

This command changes the measurement status monitor in the RUN mode.

<Command format>

CHGDISP CR

└───┘ Monitor type

<Response format>

When processing ends successfully

OK^{CR}

When processing fails

ER^{CR}

<Explanation of parameters>

Monitor type	Specifies the monitor to display. (1 to 3) 1: Profile monitor 2: Digital monitor 3: ECO monitor
--------------	--

Acquire Profile <PROFILE command>

This command acquires the profile.

<Command format>

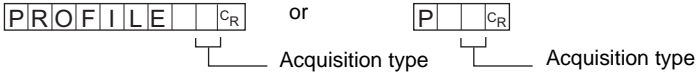

<Response format>

When processing ends successfully

- Acquisition type: when ASCII is specified

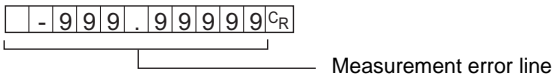
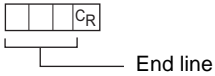
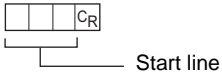
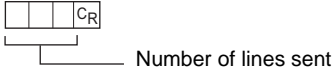

OK C_R

- Acquisition type: when Binary is specified

Binary data of 4 bytes per 1 data item x 631 points ... binary data of total 2524 bytes

CRC16 ... 2-byte binary data

OK C_R

When processing fails

ER C_R

<Explanation of parameters>

Acquisition type	Specifies the acquisition type. 0: ASCII 1: Binary
Number of lines sent	This is the number of lines in the profile that is sent. (0 to 63)
Start line	This is the start line No. of the profile.
End line	This is the end line No. of the profile.
Profile data	[ASCII] Profile data is output for the number of lines. Number of digits of integer section: 3 (fill with spaces when less than three digits) Number of digits past the decimal point: max. 5 (The specified number of digits past the decimal point is reflected.) [Binary] Measurement values are output in nanometers for the specified number of lines. Data is 4-byte data (little endian) and minus values are given as 2's complements.

Acquire Version No. <VERGET command>

This command acquires the version information of the Controller.

<Command format>

VERGET_{CR}

<Response format>

When processing ends successfully

ZG2 - VERX.XXX_{CR}

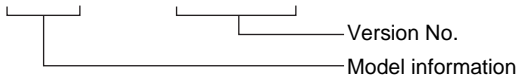

When processing fails

ER_{CR}

<Explanation of parameters>

Model information	The model No. of the Controller is returned.
Version information	The version No. of the Controller's firmware is returned.

Automatically Set Sensitivity Adjustment Range <SEARCH command>

This command automatically sets the sensitivity adjustment ranges of MULTI sensitivity/ HS MULTI sensitivity matched to the measurement target. No parameters are provided for this command.

<Command format>

```
S E A R C H C R
```

<Response format>

When processing ends successfully

```
O K C R
```

When processing fails

```
E R C R
```

Parameter List

Parameters Exclusive to the DATAGET Command

Judgment value parameters

Parameter	Unit No.	Parameter No.	Output Range
Judgment value	47+10* (task-1)	40	0: Error, 1: LOW, 2: PASS, 3: HIGH

Parameters Common to the DATASET/DATAGET Commands

Parameters at image adjustment

Sensitivity adjustment

Parameter	Unit No.	Parameter No.	Setting range
Mode selection	1	2	0: MULTI, 1: AUTO, 2: FIXED, 3: HS MULTI sensitivity(*1)
MULTI/HS MULTI HIGH	1	5	1 to 440
MULTI/HS MULTI LOW	1	6	1 to 440
MULTI STEP	1	4	0: Fine adjusting, 1: Normal, 2: Rough adjustment
AUTO HIGH	1	7	1 to 440
AUTO LOW	1	8	1 to 440
FIXED	1	9	0 to 440 (0: laser out)
HS MULTI max. number of lightings	1	10	2 to 10

*1: The SEARCH command must be executed to enable the HS MULTI sensitivity setting.

Measurement region setting

Parameter	Unit No.	Parameter No.	Setting range
Measurement start X coordinate	0	14	0 to 630
Measurement start Y coordinate	0	15	High-speed mode: 0 to 199 Standard, high-resolution mode: 0 to 399
Measurement end X coordinate	0	16	0 to 630
Measurement end Y coordinate	0	17	High-speed mode: 0 to 199 Standard, high-resolution mode: 0 to 399

Profile

Parameter	Unit No.	Parameter No.	Setting range
Inspection target	0	0	0: Standard, 1: Surface
Average	0	7	0: 1, 1: 2, 2: 4, 3: 8, 4: 16, 5: 32, 6: 64 measurements
Smooth	0	8	0: OFF, 1: LOW, 2: MID, 3: HIGH
Interpolation	0	9	0: OFF, 1: ON
Number of interpolated pixels	0	11	0: 1, 1: 2, 2: 4, 3: 8, 4: 16, 5: ALL
Noise filtering	0	10	0: 0, 1: 1, 2: 2, 3: 3, 4: 4, 5: 5, 6: 6, 7: 7
Gain	0	6	0: LV1, 1: LV2, 2: LV3, 3: LV4, 4: LV5, 5: LV6, 6: LV7
Background filtering level	0	5	0 to 255

Parameters during setting of measurement conditions

Region P

Parameter	Unit No.	Parameter No.	Setting range
P1 start	40+10* (task-1)	4	0 to 630
P1 end	40+10* (task-1)	5	0 to 630
P2 start	40+10* (task-1)	11	0 to 630
P2 end	40+10* (task-1)	12	0 to 630
P3 start	40+10* (task-1)	18	0 to 630
P3 end	40+10* (task-1)	19	0 to 630
P4 start	40+10* (task-1)	100	0 to 630
P4 end	40+10* (task-1)	101	0 to 630

Measurement point selection

Parameter	Unit No.	Parameter No.	Setting range
P1	40+10* (task-1)	6	0: Average, 1: Peak, 2: Bottom
P2	40+10* (task-1)	13	0: Average, 1: Peak, 2: Bottom
P3	40+10* (task-1)	20	0: Average, 1: Peak, 2: Bottom

Edge selection

Parameter	Unit No.	Parameter No.	Setting range
P1 edge level	40+10* (task-1)	7	High-speed mode: 0 to 199 Standard, high-resolution mode: 0 to 399
P2 edge level	40+10* (task-1)	14	High-speed mode: 0 to 199 Standard, high-resolution mode: 0 to 399
P1 edge direction	40+10* (task-1)	10	0: left → right (forward direction) 1: right → right arrow left (reverse direction)
P2 edge direction	40+10* (task-1)	17	0: left → right (forward direction) 1: right → right arrow left (reverse direction)

Calculation

Parameter	Unit No.	Parameter No.	Setting range
Calculation taskX	40+10* (task-1)	4	0: OFF, 1: TASK1, 2: TASK2, 3: TASK3, 4: TASK4, 5: TASK5, 6: TASK6, 7: TASK7, 8: TASK8
Calculation taskY	40+10* (task-1)	5	
Calculation parameter m	40+10* (task-1)	6	-10.0 to 10.0 ^(*)
Calculation parameter n	40+10* (task-1)	7	-10.0 to 10.0 ^(*)
Calculation parameter K	40+10* (task-1)	8	-999.999999 to 999.999999 ^(*)

*1: Number of digits past the decimal point cannot be handled by the DATASET command. Input as follows:
 Example: -10.0 to 10.0 → -100 to 100
 -999.999999'999.999999 → -999999999'999999999

Note

The region that can set (P1 to P3, etc.) differs according to the measurement item.

Region	Height	2-pt step	3-pt step	Edge position	Edge width	Angle	Cross-sectional area	Angle	Point of intersection
P1	Yes	Yes	Yes	Yes	Yes	Yes	Yes	Yes	Yes
P2		Yes	Yes		Yes	Yes		Yes	Yes
P3			Yes					Yes	Yes
P4								Yes	Yes

Parameters during scaling

Parameter	Unit No.	Parameter No.	Setting range
Span	40+10* (task-1)	14	-4.0000 to 4.0000 ^(*)
Offset	40+10* (task-1)	15	-999.999999 to 999.999999 ^(*)

*1: Number of digits past the decimal point cannot be handled by the DATASET command. Input as follows:
 Example: -4.0000 to 4.0000 → -40000 to 40000
 -999.999999'999.999999 → -999999999'999999999

Parameters in the ADJ mode

Judgment value

Parameter	Unit No.	Parameter No.	Setting range
Upper limit	40+10* (task-1)	15	-999.999999 to 999.999999 (*1)
Lower limit	40+10* (task-1)	14	-999.999999 to 999.999999 (*1)

Filter

Parameter	Unit No.	Parameter No.	Setting range
Average	43	3	0: 1, 1: 2, 2: 4, 3: 8, 4: 16, 5: 32, 6: 64, 7: 128, 8: 256 measurements
Smooth	42	3	0: OFF, 1: 3 (LOW), 2: 9 (MID), 3: 15 (HIGH) measurements
Hold	44	3	0: Off, 1: Peak, 2: Bottom, 3: P-P, 4: Average, 5: Sample

Zero reset

Parameter	Unit No.	Parameter No.	Setting range
Zero	40+10* (task-1)	16	-999.999999 to 999.999999 (*1)

*1: Number of digits past the decimal point cannot be handled by the DATASET command. Input as follows:
Example: -999.999999 to 999.999999 → -999999999 to 999999999

Command Processing Time

The command processing time differs according to the command. The following shows typical command processing times for the TRIG, MEASURE and PROFILE commands.

Command	Setting	Processing time	
		RS-232C (115200 bps)	USB
TRIG	Sensitivity: MULTI, CCD mode: NORMAL	280 ms	280 ms
	Sensitivity: MULTI, CCD mode: HI-RESO	550 ms	550 ms
	Sensitivity: MULTI, CCD mode: HI-SPEED	170 ms	170 ms
	Sensitivity: FIXED, CCD mode: NORMAL	20 ms	20 ms
	Sensitivity: FIXED, CCD mode: HI-RESO	30 ms	30 ms
	Sensitivity: FIXED, CCD mode: HI-SPEED	10 ms	10 ms
MEASURE	–	10 ms	10 ms
PROFILE 0 (profile output format: ASCII)	–	1500 ms	1000 ms
PROFILE 1 (profile output format: binary)	–	250 ms	30 ms

The command processing time above shows measurement values for the ECO monitor.

MEASUREMENT BY GANG-MOUNTED CONTROLLERS

Mounting Order and Assignment of CH Numbers	184
Setup Example	185
Required Settings	187

Mounting Order and Assignment of CH Numbers

With the ZG2 series, one Data Storage Unit (ZG2-DSU) and up to two Controllers (ZG2-WDC) can be gang-mounted. Gang-mount these devices in correct combinations and arrangements using the Controller Link Unit (sold separately).

The channel numbers in a gang-mount configuration are assigned automatically when correct connections have been made using the Controller Link Unit.



Combinations of Gang-mounted Controllers p.47



CH number when Controllers are gang-mounted p.48

Setup Example

When two Controllers are gang-mounted, measurement values from two Sensor Heads can be acquired and calculations performed on these values. This enables measurement of wide measurement targets.

Measuring Wide Measurement Targets

Mount the two Sensor Heads aligned with the left and right of the measurement target.

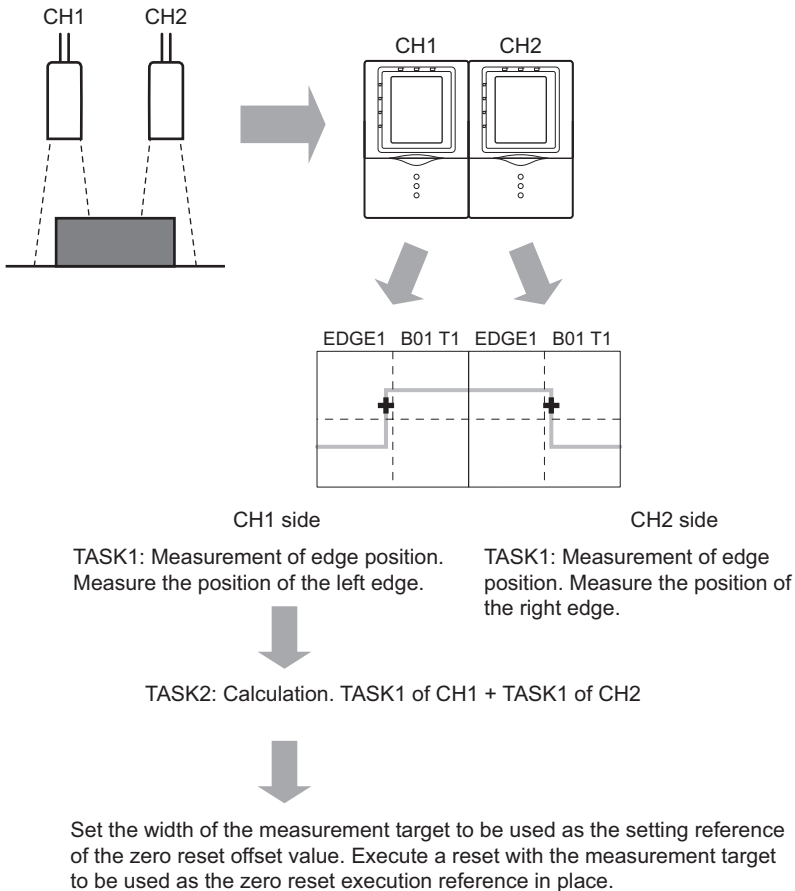

Note

- How to gang-mount Controllers

 Mounting and Connecting Devices p.27

- Edge position measurement

 Measuring Position and Width p.77

- Calculation

 Calculating Measurement Values p.86

Calculations Performed on Measurement Values Obtained on Multiple Channels
p.190

- Setting zero reset

 Executing Reference Zero Reset p.115

Setting the Offset Value p.114

Important

Set calculation and zero reset on the Controller assigned channel number 1 (CH1).

Required Settings

Setting Mutual Interference Prevention

When two Sensor Heads are mounted next to each other, laser light reflected from each Sensor Head sometimes interferes with the light from the other, preventing light from being received correctly on each Sensor Head. If this happens, set the mutual interference prevention function ON. This function causes the lighting timing of the two Sensor Heads to be shifted slightly, which prevents mutual interference of the two adjacent Sensor Heads. Set this function on the Controller assigned channel number 2 (CH2).

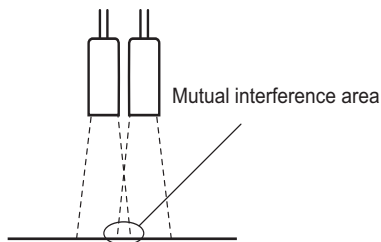

► CH2 side-FUN mode-[SYSTEM]-[SYNC]

Setting value	Description
DISABLE (OFF)	<p>The two Sensor Heads are lit at the same timing. (default value) With this setup, mount Sensor Heads slightly apart from each other to prevent mutual interference.</p> <p> Adjusting Mutual Interference p.200</p>
ENABLE (ON)	<p>The lighting timing of the Sensor Heads is shifted slightly to prevent mutual interference. Even if Sensor Heads are mounted next to each other, measurement can be performed without one Sensor Head being influenced by the other. Note, however, that a calculation error occurs when moving objects are measured since the measurement timing shifts.</p>

Measurement timing charts

Mutual interference prevention function: OFF

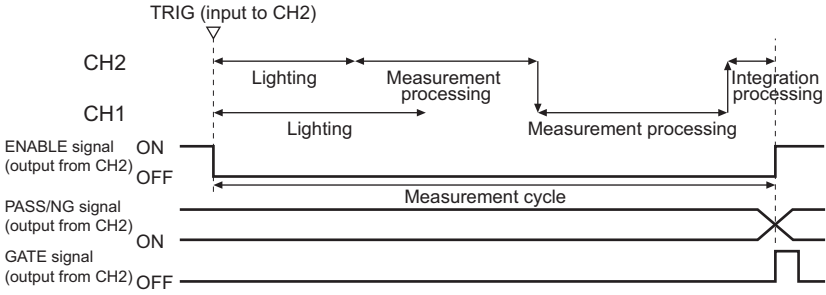

Mutual interference prevention function: ON

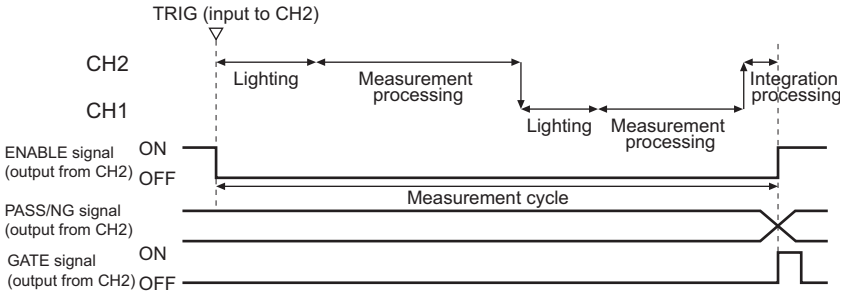

Settings Common to Gang-mounted Controllers

The table below summarizes the settings that should be set in common to both gang-mounted Controllers. Set these on the CH2 Controller. The settings made on the CH2 Controller are automatically reflected on the CH1 Controller.

Setting	Reference
CCD mode setting (standard/high-resolution/high-speed)	p.121
Sensitivity adjustment (MULTI/HS MULTI/AUTO/FIXED)	p.96
High-power mode settings (increases amount of light emitted from Sensor Head) (OFF/ON)	p.105
Setting for measurement by trigger (TRIG) signal (enabled/disabled)	p.136
Node No. setting (0 to 16)	p.156
Delimiter setting (CR, LF, CR+LF)	p.156
Operation of Controller's mode switch (FUN/ADJ/RUN)	p.52

Calculations Performed on Measurement Values Obtained on Multiple Channels

When performing measurement with Controllers in a gang-mount configuration, calculations must be performed on measurement values obtained on multiple channels. Set these calculations on the CH1 Controller. When Controllers are gang-mounted, the channel selection menu is added to the calculation menu on the CH1 Controller.

► CH1-side-FUN mode-[MEAS]-[SENS]-[CALC]-[CUSTOM]-[TASK]-[X/Y]

Additional menu in gang-mount configuration	Description
CH selection	When setting X/Y in equations, first select the CH number and then specify the task number. OFF: No CH selected (default value) CH1: Task number on CH1-side Controller can be selected. CH2: Task number on CH2-side Controller can be selected.



Calculating Measurement Values p.86
Measuring Wide Measurement Targets p.185

I/O

The table below summarizes the I/O of each channel when Controllers are gang-mounted.

I/O		Description	
Controller I/O cable	Input	TRIG signal	This signal is input to CH2. CH1 is automatically interlocked to this signal.
		LD-OFF signal	These signals are input to each channel.
		BANK A to D signals	
		ZERO-RESET signal	
	Output	ENABLE signal	These signals are integrated and output to CH2.
		GATE signal	
		ALL-PASS	The overall judgment of all tasks on CH1 and CH2 is integrated and output from CH2.
		NG	
ERROR		This signal is output from each channel.	
Serial communication	Connection	USB cable/ RS-232C cable	Connect to the CH2-side Controller.
		When Smart Monitor ZG2 is used	Connect to the CH2-side Controller.
	Input	Command input	This input can be sent to both channels by prefixing commands with "#01/#02". When the channel number is omitted from the command prefix, the command destination is assumed to be CH2.
	Output	Auto output	This signal is output from each channel.

ZG2-WDC (CH1)

ZG2-WDC (CH2)

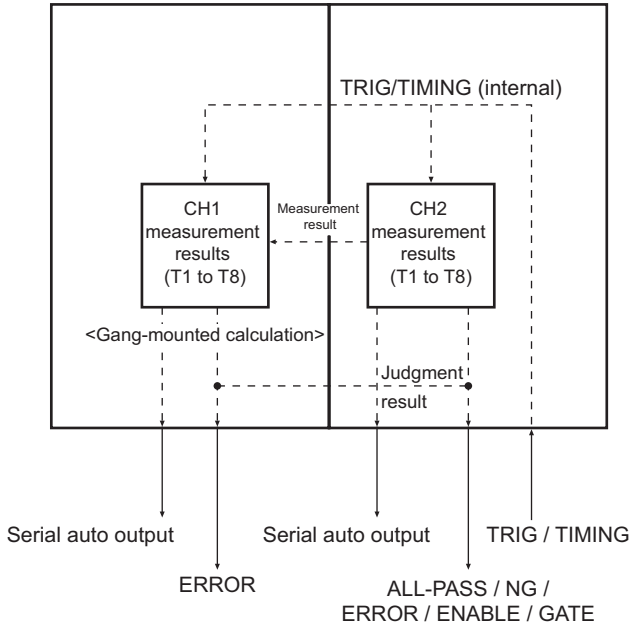

APPENDICES

Specifications and External Dimensions	194
Error Messages and Corrective Actions	211
Troubleshooting	213
Menu List	216
List of Key Operations	218
Laser Safety	219
Requirements from Regulations and Standards	222
Compliance with EC Directives	231
Updating the Firmware	232
Index	237

Specifications and External Dimensions

Sensor Head

Specifications

ZG2-WDS70/WDS22

Item	ZG2-WDS70	ZG2-WDS22	
Optical system	Diffuse reflection	Diffuse reflection Regular reflection	
Measurement center distance (height direction)	210 mm	100 mm 94 mm	
Measurement range	Height direction	±48 mm (high-resolution mode) ±12 mm (in standard mode) ±10 mm (in standard mode)	
	Width direction	70 mm typ. 22 mm typ.	
Resolution	Height direction ^(*1)	6 μm 2.5 μm	
	Width direction	70 mm/631 pix 22 mm/631 pix	
Linearity (height direction) ^(*2)	±0.1% F.S.		
Temperature characteristics ^{*3}	0.02% F.S./°C		
Light source	Type	Visible semiconductor laser	
	Wavelength	658 nm	
	Output	Max. output 5 mW, max. exposure (without use of optical equipment) 1 mW	
	Laser class	Class 2M of EN60825-1/IEC60825-1 Class IIIB of FDA(21CFR 1040.10 and 1040.11)	
Beam shape (at measurement center distance) ^(*4)	120 μm × 75 mm typ.	60 μm × 45 mm typ.	
LED indicator	STAND BY: Turns ON when laser emission is ready (green) LD_ON: Turns ON when laser is emitted (green)		
Measurement target	Non-transparent object surface	Non-transparent object/transparent object surface	
Environmental performance	Ambient operating illumination	Illumination on received light surface 7000 lx max.: (incandescent light)	
	Ambient temperature	Operating: 0 to 50°C Storage: -15 to +60°C (with no icing or condensation)	
	Ambient humidity	Operating and storage: 35% to 85%RH (with no condensation)	
	Degree of protection	IP66 (IEC60529)	
	Vibration resistance (durability)	10 to 150 Hz (at a single-amplitude of 0.35 mm) for 80 minutes each in the X, Y, and Z directions	
	Shock resistance (destructive)	150 m/s ² 3 times each in six directions (up/down, left/right, forward/backward)	
Material	Case: aluminum die-cast, Front cover: glass Cable sheath: heat-resistant PVC, Connector: Zinc alloy and brass		
Cable length	0.5, 2 m (flexible cable)		
Minimum bending radius	68 mm		
Weight	Approx. 650 g	Approx. 500 g	
Accessories	Laser warning labels (IEC60825-1 2 sheets), ferrite core (1 p'ce), Instruction Sheet		

ZG2-WDS8T/WDS3VT

Item		ZG2-WDS8T		ZG2-WDS3VT	
Optical system		Diffuse reflection	Regular reflection	Regular reflection	Diffuse reflection
Measurement center distance (height direction)		50 mm	44 mm	22.3mm	10.6 mm
Measurement range	Height direction (in standard mode)	±3 mm	±2 mm	±0.5 mm	±0.4 mm
	Width direction	8 mm typ.		3 mm typ.	
Resolution	Height direction (*1)	1 μm		0.25 μm	
	Width direction	8 mm/631 pix		3 mm/631 pix	
Linearity (height direction) (*2)		±0.1% F.S.			
Temperature characteristics *3		0.03% F.S./°C		0.08% F.S./°C	
Light source	Type	Visible semiconductor laser			
	Wavelength	658 nm		650 nm	
	Output	Max. output 5 mW, max. exposure (without use of optical equipment) 1 mW		1 mW max.	
	Laser class	Class 2M of EN60825-1/IEC60825-1 Class IIIB of FDA(21CFR 1040.10 and 1040.11)		Class 2 of EN60825-1/IEC60825-1 Class II of FDA(21CFR 1040.10 and 1040.11)	
Beam shape (at measurement center distance) (*4)		30 μm × 24 mm typ.		25 μm × 4 mm typ.	
LED indicator		STAND BY: Turns ON when laser emission is ready (green) LD_ON: Turns ON when laser is emitted (green)			
Measurement target		Non-transparent object/transparent object surface			
Environmental performance	Ambient operating illumination	Illumination on received light surface 7000 lx max. (incandescent light)			
	Ambient temperature	Operating: 0 to 50°C Storage: -15 to +60°C (with no icing or condensation)			
	Ambient humidity	Operating and storage: 35% to 85%RH (with no condensation)			
	Degree of protection	IP66 (IEC60529)		IP67 (IEC60529)	
	Vibration resistance (durability)	10 to 150 Hz (at a single-amplitude of 0.35 mm) for 80 minutes each in the X, Y, and Z directions			
	Shock resistance (destructive)	150 m/s ² 3 times each in six directions (up/down, left/right, forward/backward)			
Material		Case: aluminum die-cast, Front cover: glass Cable sheath: heat-resistant PVC, Connector: Zinc alloy and brass			
Cable length		0.5, 2 m (flexible cable)			
Minimum bending radius		68 mm			
Weight		Approx. 500 g		Approx. 300 g	
Accessories		Laser warning labels (EN: 2 labels, FDA: 3 labels), ferrite core (1 p'ce), Instruction Sheet			

*1: When an OMRON-standard measurement target is placed at the measurement center distance, and its average height of all lines is measured. Conditions are as follows. Note that the resolution performance may not be satisfied in the presence of strong magnetic fields. The resolution of ZG2-WDS8T/WDS3VT is min. 0.25

μm, and higher resolution than that value is not obtained even if the average number of measurements is increased.

Model	CCD mode	Average number of times	Measurement target	
			Regular reflection	Diffuse reflection
ZG2-WDS70/WDS22/WDS8T	High-resolution mode	64 times	OMRON-standard white alumina ceramic	
ZG2-WDS3VT	High-resolution mode	64 times	OMRON-standard specular object	OMRON-standard diffuse reflecting object

- *2: This is the error in relationship to an ideal straight line when an OMRON-standard measurement object was measured to calculate the average height of all lines. The CCD mode is the standard mode. Linearity sometimes changes according to the measurement target.

Model	Measurement target	
	Regular reflection	Diffuse reflection
ZG2-WDS70/WDS22/WDS8T	OMRON-standard white alumina ceramic	
ZG2-WDS3VT	OMRON-standard specular object	OMRON-standard diffuse reflecting object

- *3: Value obtained when the Sensor Head and measurement target are fixed with an aluminum jig. The CCD mode is the standard mode.
- *4: Defined as $1/e^2$ (13.5%) of the central light intensity. Leakage of light is also present in areas other than those defined. So, the beam diameter is sometimes influenced where the reflectance of the area surrounding the measurement target is higher than that of the measurement target itself.

External Dimensions

ZG2-WDS70

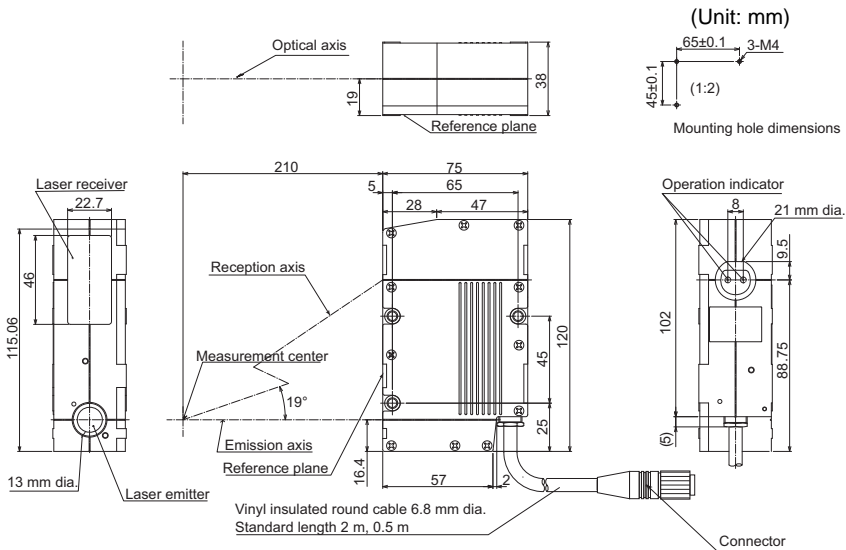

ZG2-WDS8T/WDS22

- When used for diffuse reflection

(Unit: mm)

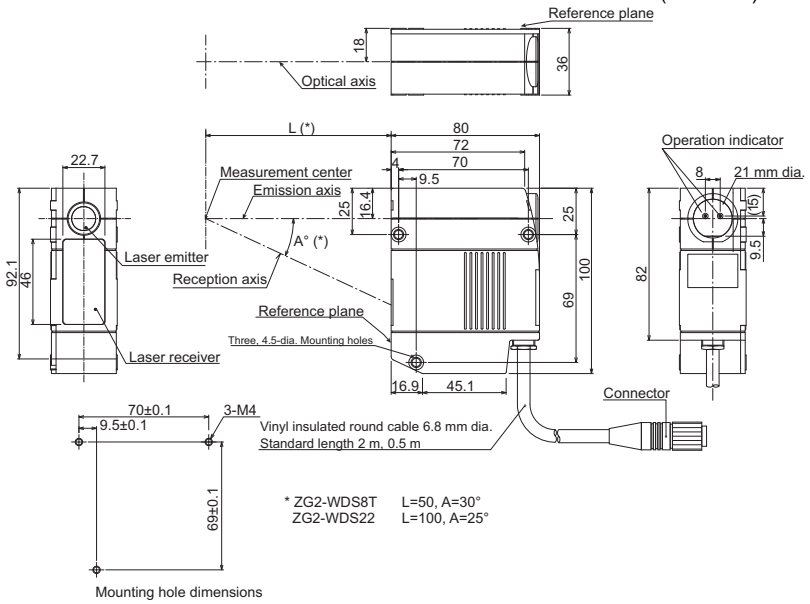

- When used for regular reflection (ZG2-WDS8T)

(Unit: mm)

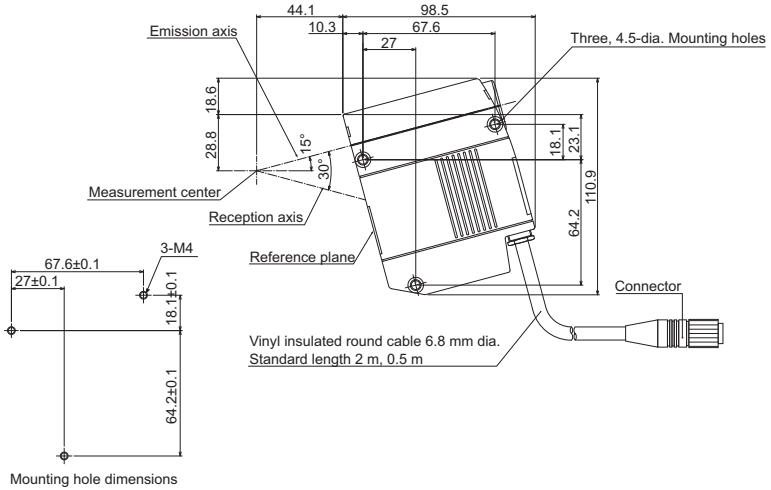

- When used for regular reflection (ZG2-WDS22)

(Unit: mm)

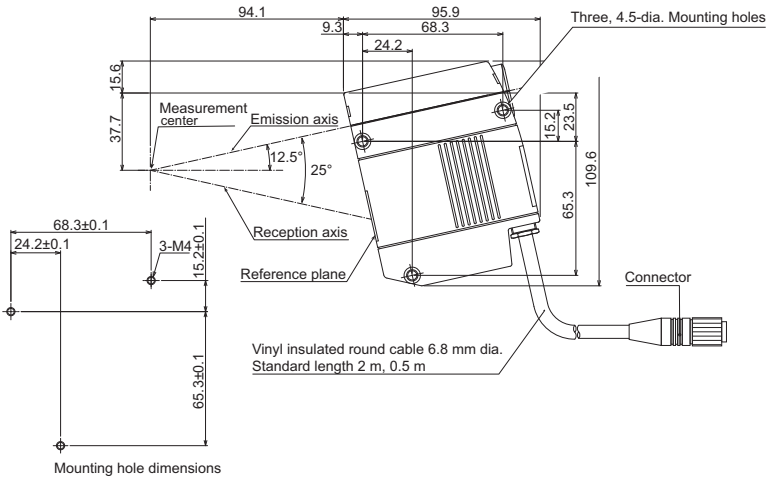

ZG2-WDS3VT

- When used for regular reflection

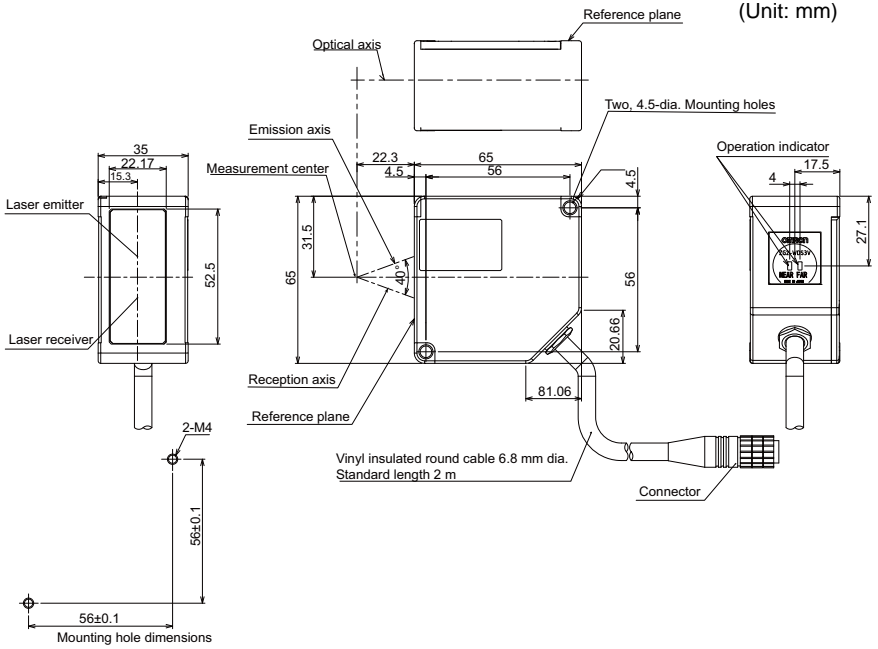

- When used for diffuse reflection

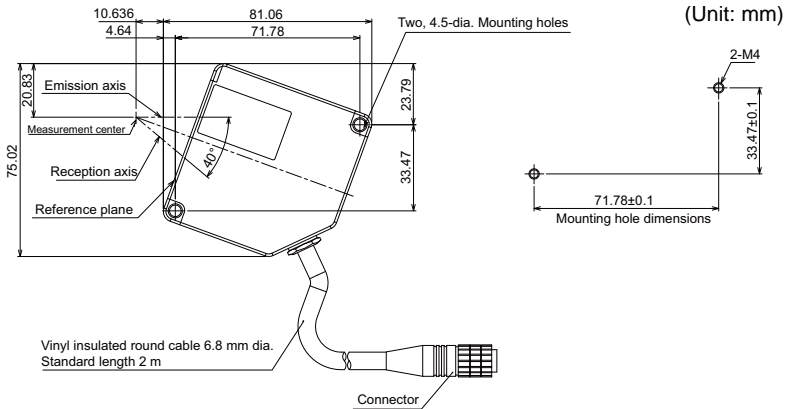

Adjusting Mutual Interference

When using two or more Sensor Heads next to each other, mutual interference will not occur if other Sensor Head beams are outside the shaded areas in the following diagrams.

Also, the mutual interface prevention function ensures that measurement is performed correctly even when beams overlap on the measurement object (stationary object).

 Setting Mutual Interference Prevention p.187

Important

When the measurement object is a moving object, install the Sensor Heads so that beams do not overlap.

ZG2-WDS70

(Unit: mm)

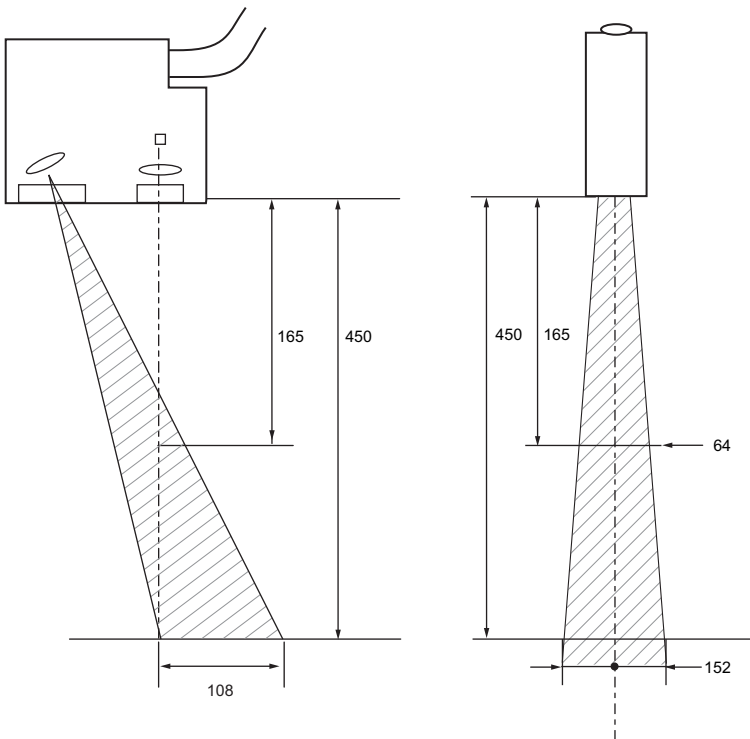

ZG2-WDS3VT

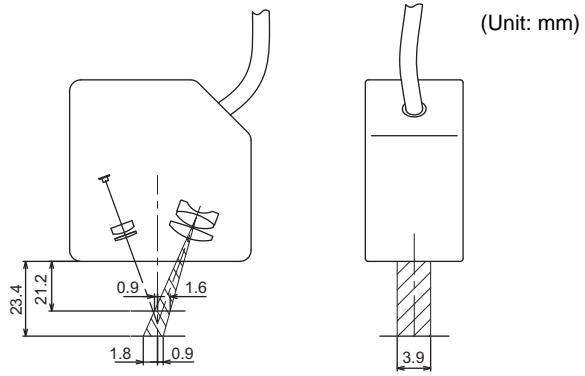

ZG2-WDS22

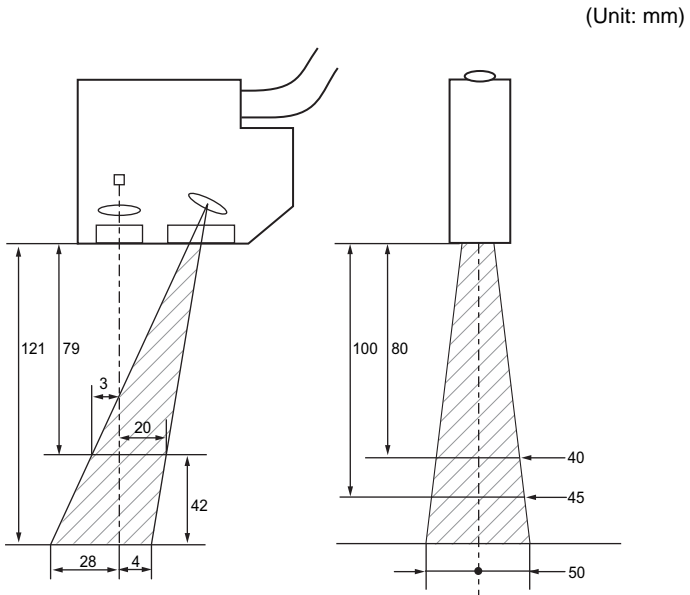

(Unit: mm)

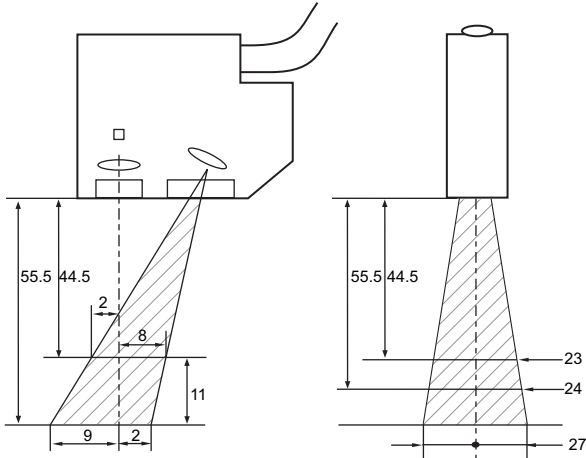

Controller

Specifications

Item		ZG2-WDC11/WDC11A	ZG2-WDC41/WDC41A
I/O type		NPN type	PNP type
Number of connected Sensor Heads		1 Sensor/Controller	
Max. number of gang-mounted Controllers		2	
Measurement cycle ^(*)		16 ms (high-resolution mode), 8 ms (standard mode), 5 ms (high-speed mode)	
Minimum display unit		10 nm	
Display range		-999.99999 to 999.99999	
Display	LCD monitor	1.8" TFT color LCD (557 × 234 pix)	
	Indicator	<ul style="list-style-type: none"> Individual task judgment indicator (orange): T1, T2, T3, T4 Laser indicator (green): LD ON Zero Reset indicator (green): ZERO Trigger indicator (green): TRIG 	
External I/F	I/O signal wire	Analog output	Selectable from voltage/current (selected by slide switch on base) <ul style="list-style-type: none"> At voltage output:-10 to +10V Output impedance: 40 Ω At current output:4 to 20 mA Max. load resistance: 300 Ω
		Judgment (ALL-PASS/NG/ERROR)	NPN open-collector 30 V DC, 50 mA max. Residual voltage 1.2 V max.
		Trigger auxiliary output (ENABLE/GATE)	PNP open-collector, 50 mA max. Residual voltage 1.2 V max.
		Laser stop input (LD OFF)	ON : Short-circuited with 0 V terminal or 1.5 V max. OFF: Open (leakage current: 0.1 mA max.)
		Zero reset input (ZERO)	ON : Supply voltage short-circuited or within supply voltage -1.5 V max. OFF: Open (leakage current: 0.1 mA max.)
		Measurement trigger input (TRIG)	
	Bank switching input (BANK A, B)		
Serial I/O	USB2.0	1 port, FULL SPEED [12 Mbps], MINI-B	
	RS-232C	11 port, max. 115,200 bps	
Main functions	Number of registered setups	16 banks	
	Sensitivity adjustment function	MULTI/HS MULTI/AUTO/FIXED	
	Measurement items (ITEM)	Height/Position/Step/Width/Cross-sectional area/Point of intersection angle/point of intersection position/Calculation (max. 8 items simultaneously selectable)	
	Auxiliary functions	Position correction function (height/position/slope)/Calculations between Controllers	
	Trigger mode	External trigger/continuous	

Item		ZG2-WDC11/WDC11A	ZG2-WDC41/WDC41A
Ratings	Power supply voltage	21.6 V to 26.4 V DC (including ripple)	
	Current consumption	0.8 A max.	
	Insulation resistance	Across all lead wires and Controller case: 20 MΩ (by 250 V megger)	
	Dielectric strength	Across all lead wires and Controller case, 1000 V AC, 50/60 Hz, 1 min	
Operation environment robustness	Ambient temperature	Operating: 0 to +50°C Storage: -15 to +60°C (with no icing or condensation)	
	Ambient humidity	Operating and storage: 35% to 85%	
	Degree of protection	IP20 (IEC60529)	
	Vibration resistance (durability)	Vibration frequency: 10 to 150 Hz Single-amplitude: 0.35 mm Acceleration: 50 m/s ² 10 times for 8 minutes	
	Shock resistance (destructive)	150 m/s ² 3 times each in 6 directions (up/down, left/right, forward/backward)	
Material	Case: Polycarbonate (PC), Cable sheath: heat-resistant PVC		
Cable length	2 m		
Weight	Approx. 300 g (including cable) (when packaged: approx. 450 g)		
Accessories	ZG2-WDC_1: ferrite core (large) (1 p'ce), Insure Lock (1 p'ce), Instruction Sheet ZG2-WDC_1A: ferrite core (large) (1 p'ce), ferrite core (small) (2 p'ces), Insure Lock (1 p'ce), Instruction Sheet, setup software (CD-ROM), USB cable		

*1 The measurement cycle stated here is for when the FIXED/AUTO sensitivity modes are selected. The measurement cycle increases when the MULTI sensitivity/high-speed MULTI sensitivity mode is selected and according to other settings. Also, when the high power mode is set to ON, the shortest measurement cycle becomes 95 ms regardless of the CCD mode setting. Check the actual measurement cycle by the ECO monitor in the RUN mode.

Controller signal statuses

Input specifications

	FUN mode	ADJ mode	RUN mode	
			Continuous (trigger disabled)	Trigger
LD-OFF	Enabled	Enabled	Enabled	Enabled
ZERO-RESET	Disabled	Disabled	Enabled	Enabled
TRIG	Disabled	Disabled	Disabled	Enabled

Output specifications

	FUN mode	ADJ mode	RUN mode	
			Continuous (trigger disabled)	Trigger
ALL-PASS	OFF	OFF	ON/OFF	ON/OFF
NG	OFF	OFF	ON/OFF	ON/OFF
ERROR	OFF	OFF	ON/OFF	ON/OFF
GATE	OFF	OFF	ON/OFF	ON/OFF

	FUN mode	ADJ mode	RUN mode	
			Continuous (trigger disabled)	Trigger
ENABLE	OFF	OFF	ON	ON/OFF
Analog	Clamp value	Clamp value	Measurement value/clamp value	
Parallel Output Unit	OFF	OFF	Measurement value/status output ^(*)	

*1 For details, see "Chapter 4 CONNECTION WITH EXTERNAL DEVICES." p.125

External Dimensions

ZG2-WDC11/WDC41

(Unit: mm)

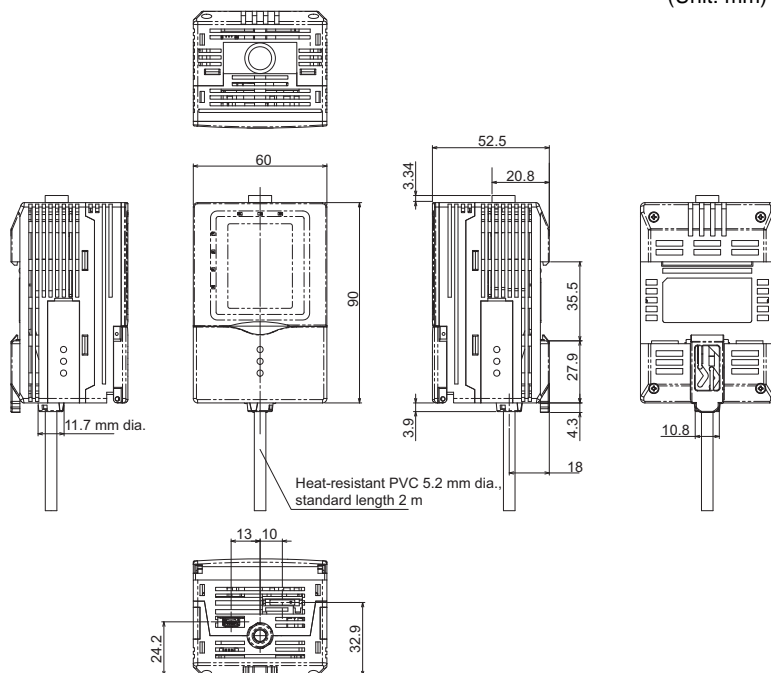

Accessories

Panel Mount Adapters

ZS-XPM1/XPM2

- When mounting on a panel

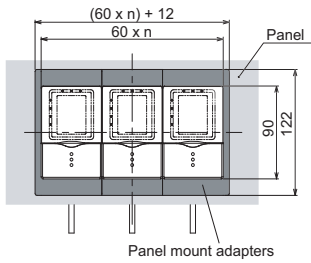

* When multiple units are used in a line
Panel cutout dimensions

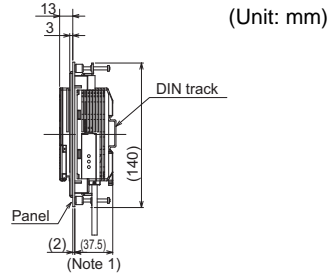
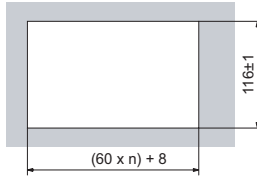

Note 1: Dimensions when the panel thickness is 2.0 mm

Important

When mounting multiple Controllers on a panel, be sure to install the DIN track on the rear side of the Controllers for support.

Item	ZG2-WDC series	ZS-XPM1 (for 1st unit)	ZS-XPM2 (for 2nd unit onwards)
Appearance			
Applicable Controller	ZG2-WDC series		
Vibration resistance (durability)	10 to 150 Hz (0.7 mm double amplitude), 80 min each in X, Y, and Z directions		
Shock resistance (destructive)	300 m/s ² 3 times each in six directions (up/down, left/right, forward/backward)		
Material	Polycarbonate (PC), etc.		
Weight	Approx. 50 g		
Accessories	Instruction Sheet		

Extension cable

ZG2-XC_CR

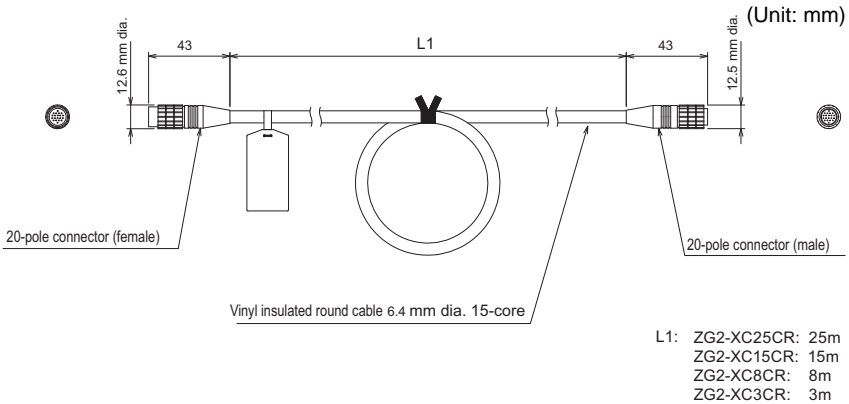

Item	ZG2-XC25CR	ZG2-XC15CR	ZG2-XC8CR	ZG2-XC3CR
Cable length	25 m	15 m	8 m	3 m
Cable type	Flexible cable			
Applicable Sensor Head/ Controller	ZG2 series			
Ambient temperature	Operating: 0 to +50°C, Storage: -15 to +60°C (with no icing or condensation)			
Ambient humidity	Operating and storage: 35% to 85% (with no condensation)			
Vibration (resistance)	10 to 150 Hz (0.7 mm double amplitude), 80 min each in X, Y, and Z directions			
Shock resistance (destructive)	300 m/s ² 3 times each in six directions (up/down, left/right, forward/backward)			
Material	Cable sheath: Heat-resistant vinyl chloride (PVC)			
Weight	Approx. 1.4 kg	Approx. 1.0 kg	Approx. 0.5 kg	Approx. 0.2 kg
Accessories	Ferrite cores (2 p'ces), Insure Lock (2 p'ces), Instruction Sheet			

RS-232C cable

ZS-XPT2 (for connecting to programmable controller/programmable terminal)

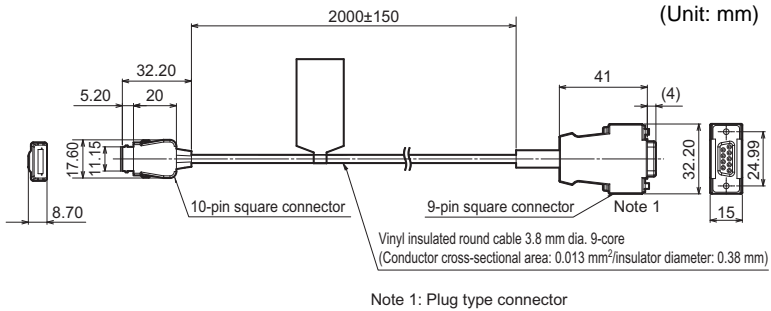

ZS-XRS2 (for connecting to a personal computer)

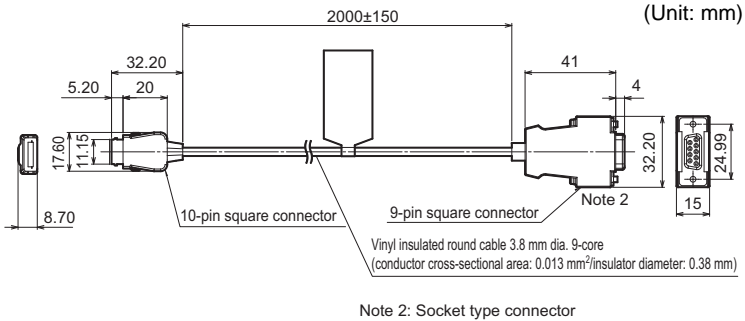

Item	ZS-XRS2	ZS-XPT2
Applicable Controller	ZG2 series, ZS series	
Ambient temperature	Operating: 0 to +50°C, Storage: -15 to +60°C (with no icing or condensation)	
Ambient humidity	Operating and storage: 35% to 85% (with no condensation)	
Dielectric strength	1,000 V AC, 50/60 Hz for 1 min	
Insulation resistance	100 MΩ (by 500 V DC megger)	
Vibration (resistance)	10 to 150 Hz (0.7 mm double amplitude), 80 min each in X, Y, and Z directions	
Shock resistance (destructive)	300 m/s ² 3 times each in six directions (up/down, left/right, forward/backward)	
Material	Cable sheath: Heat-resistant vinyl chloride (PVC)	
Weight	Approx. 50 g	
Accessories	Instruction Sheet	

Real-Time Parallel Output Unit

ZG-RPD11/RPD41

(Unit: mm)

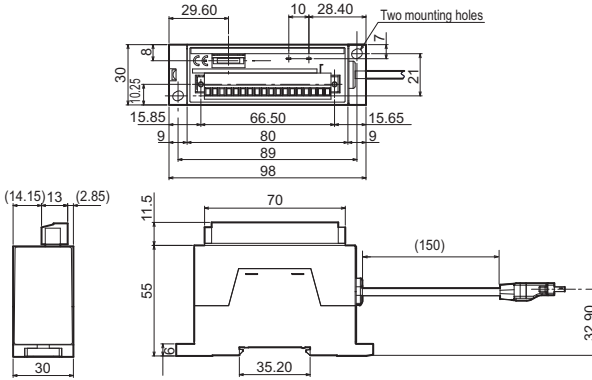

Item		ZG-RPD11	ZG-RPD41
I/O type		NPN type	PNP type
Data output system		16-bit parallel open collector output	
Data format		The measurement value is converted to 16-bit binary data (2's complement) before it is output (signal names: D0 to D15).	
Synchronization signal		Synchronization signal for notifying data determination timing (signal name: GATE). 1-bit open collector output	
Parallel output	Judgment output	NPN open collector, 30 VDC max., 20 mA max., residual voltage 1.2 V or less	PNP open collector, 20 mA max., residual voltage 1.2 V or less
	Measurement output		
RS-232C		1 port, max. 115,200 bps	
Status indicators		<ul style="list-style-type: none"> •PWR indicator (green) → Lights when ZG-RPD is energized. •ERR indicator (red) → Lights up when an energizing current of 20 mA or more flows to 1 bit or more of the open collector output (data output: 16 bits, GATE: 1 bit) 	
Circuit internal power supply voltage		24 VDC and 3.3 VDC. Power is supplied from ZG2-WDC_1 via exclusive connector.	
Current consumption		0.5 A max.	
Insulation resistance		Connected to ZG2-WDC_1, across all lead wires and controller case of the ZG2-WDC_1: 20 MΩ (by 250 V megger)	
Dielectric strength		Connected to ZG2-WDC_1, across all lead wires and controller case of the ZG2-WDC_1: 1000 VAC, 50/60 Hz 1 min	
Vibration (resistance)		10 to 150 Hz (0.7 mm double amplitude), 80 min each in X, Y, and Z directions	

Item	ZG-RPD11	ZG-RPD41
Shock resistance (destructive)	300 m/s ² 3 times each in six directions (up/down, left/right, forward/backward)	
Ambient temperature	Operating: 0 to +50°C, Storage: -15 to +60°C (with no icing or condensation)	
Ambient humidity	Operating and storage: 35% to 85% (with no condensation)	
Material	Case: ABS	
Weight	Approx. 130 g (excluding packing materials and accessories)	
Accessories	Instruction Sheet	

Controller Link Unit

ZS-XCN

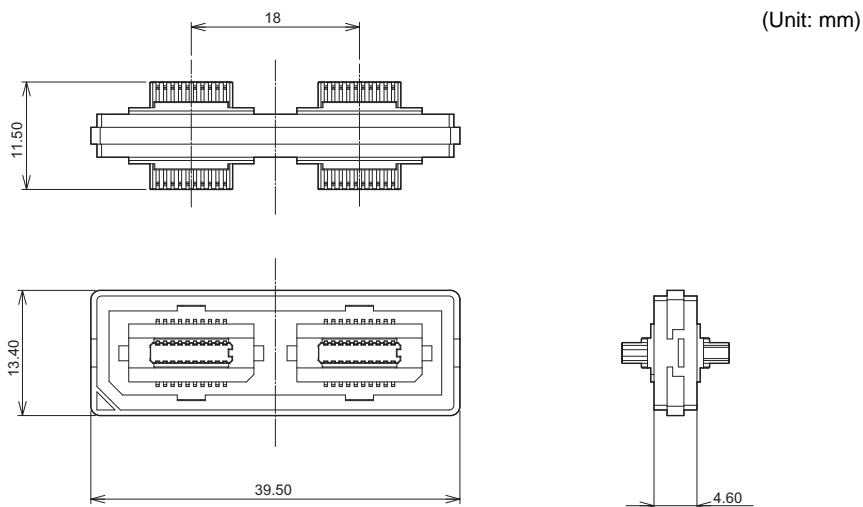

Item	ZS-XRS2	ZS-XPT2
Applicable Controller	ZG2 series, ZS series, ZFV series	
Ambient temperature	Operating: 0 to +50°C, Storage: -15 to +60°C (with no icing or condensation)	
Ambient humidity	Operating and storage: 35% to 85% (with no condensation)	
Vibration (resistance)	10 to 150 Hz (0.7 mm double amplitude), 80 min each in X, Y, and Z directions	
Shock resistance (destructive)	300 m/s ² 3 times each in six directions (up/down, left/right, forward/backward)	
Material	Polycarbonate(PC), etc	
Weight	Approx. 10 g	

Error Messages and Corrective Actions









The following shows error messages that are displayed on the LCD screen and their corrective actions.













Error message	Probable cause	Reference
AUTO SETTING FAILED	Automatic setting cannot be executed on the current region. Set the region again referring to the manual.	p.70
AUTO SCALING DO NOT OPERATE AB. THIS ITEM	The auto-scaling function does not operate with cross-sectional area and angle.	p.91
REFERENCE REGISTRATION FAILED	Failed to register the reference for position correction. 1. Check whether or not teaching of the profile has been successful. 2. Check whether or not the edge level has been set correctly.	p.109
NO MEASUREMENT POINT	There is no measurement target. Place the measurement target inside the measurement range.	p.91
SYSTEM ERROR VDIN END ERR	Communication with the Sensor Head is not possible. 1. Check the cable connection with the Sensor Head. 2. Check the cable for breaks. If there is no problem with the above, a probable cause is a Sensor Head or Controller malfunction.	p.49
SYSDATA ERROR	Loading of the system data failed. 1. Check the communication cable connection. 2. Check the communication settings. 3. Check to see if the correct file has been sent.	p.149
SCALING FAILED	The scaling correction range was exceeded. Check the input values.	p.91
SET VALUE ERROR HIGH, LOW	Review the setting values so that HIGH>LOW.	p.64
SET VALUE ERROR MAX, MIN	Review the setting values so that MAX>MIN.	p.132 p.134
CLEAR BANK DATA	When the CCD mode is changed, all bank data is initialized.	p.121 p.23
BANKDATA ERROR	Loading of the bank data failed. 1. Check the communication cable connection. 2. Check to see if the correct file has been sent.	p.149

Error message	Probable cause	Reference
HEAD IS NOT CONNECTED ^(*1)	<p>Communication with the Sensor Head is not possible.</p> <ol style="list-style-type: none"> 1. Check the cable connection with the Sensor Head. 2. Check the cable for breaks. <p>If there is no problem with the above, a probable cause is a Sensor Head or Controller malfunction.</p>	p.49
NEIGHBOR UNIT IS NOT CONNECT	<p>A Controller used in a gang-mounted configuration is used as a standalone device.</p> <ol style="list-style-type: none"> 1. To use the Controller in a gang-mounted configuration, check the connection to see if it is gang-mounted correctly. 2. To use the Controller and a standalone device, press [OK] to start up the Controller and save the settings. 	p.47 p.123

*1 When the Sensor Head is not connected, the Controller screen darkens, making the error message no longer visible.

Troubleshooting

Phenomenon	Corrective action	Reference
Profile is unstable, preventing normal measurement.	Use the APS (Automatic Profile Setup) function.  FUN mode-[MEAS]-[IMAGE]-MENU/VIEW key	p.60
	(1) When the measurement target is dark: → Set larger sensitivity-related setting values. If this does not remedy the problem, proceed to (6) → (7) → (8).  FUN mode-[MEAS]-[IMAGE]-[LD-POWER]	p.96
	(2) When differences in the color and angle of the measurement target cause the amount of received light to vary: → Use AUTO sensitivity.  FUN mode-[MEAS]-[IMAGE]-[LD-POWER]-[AUTO]	p.97
	(3) When the color and angle of the measurement target differ from place to place: → Use MULTI sensitivity/HS MULTI sensitivity.  FUN mode-[MEAS]-[IMAGE]-[LD-POWER]-[MULTI] FUN mode-[MEAS]-[IMAGE]-[LD-POWER]-[HS MULTI]	p.97
	(4) When external light, etc. disrupts the profile: → Increase the background filtering level. If this does not remedy the problem, proceed to (5)  FUN mode-[MEAS]-[IMAGE]-[CUT]	p.104
	(5) When the profile contains a lot of noise: → Set the background filtering level and noise filter.  FUN mode-[MEAS]-[IMAGE]-[CUT] FUN mode-[MEAS]-[IMAGE]-[NOISE]	p.104
	(6) When the profile is incomplete due to poor reflectance from the measurement object: → Lower the background filtering level. If this does not remedy the problem, proceed to (7) → (8)  FUN mode-[MEAS]-[IMAGE]-[CUT]	p.104
	(7) When adjustment of the sensitivity or background filtering level does not remedy problems when the measurement target is dark or reflectance is poor: → Use the high-power mode. If this does not remedy the problem, proceed to (8)  FUN mode-[MEAS]-[IMAGE]-[HI-POWER]	p.105
(8) When an insufficient amount of light prevents the profile from being displayed normally: → Adjust the received light gain.  FUN mode-[MEAS]-[IMAGE]-[GAIN]	p.105	

Phenomenon	Corrective action	Reference
I want to use the measurement results any time I want to.	Perform trigger measurement. A trigger signal can be input to control measurement timing.  FUN mode-[I/O]-[I/O LINE]-[TRIGGER]	p.136
	Use the hold function.  ADJ mode-MENU/VIEW key-[OUT]-[HOLD]	p.112
I want to use the sensor in fast line speed processes, but measurement cannot keep up with the line speed.	Change the CCD mode to the high-speed mode.  FUN mode-[SYSTEM]-[CCD MODE]	p.121
	Use HS MULTI sensitivity.  FUN mode-[MEAS]-[IMAGE]-[LD-POWER]-[HSMULTI]	p.96
I want to improve measurement accuracy.	When using fixed sensitivity, view the image in the RUN mode and if it appears saturated (received light surface of measurement target looks bloated), either adjust the sensitivity to a lower setting, or use AUTO sensitivity, MULTI sensitivity, or HS MULTI sensitivity.  FUN mode-[MEAS]-[IMAGE]-[LD-POWER]	p.96
	Change the CCD mode to the high-resolution mode.  FUN mode-[SYSTEM]-[CCD MODE]	p.121
The profile is inclined, resulting in poor height/step measurement accuracy.	Set Sensor Head installation correction.  FUN mode-[SYSTEM]-[HEAD SET]-[CORECT]	p.118
The measurement target contains a variety of angles, preventing stable measurement.	Set angle correction, and register positions to be used as the reference.  FUN mode-[MEAS]-[CORECT]-[SLOPE]-[REF. POINT]	p.107
The measurement target contains a variety of positions, preventing stable measurement.	Set height/position correction, and register positions to be used as the reference.  FUN mode-[MEAS]-[CORECT SET]-[HGT POSN]-[REF. POINT]	p.109
Measurement results do not match actual values.	Set scaling.  FUN mode-[MEAS]-[SENS]-[TASK1 to 8]-[SCALE]	p.91
I want to set specific analog output values.	Set output scaling.  FUN mode-[I/O]-[ANALOG]-[SCALE]-[ON]	p.132
The analog output values do not match the display values.	Set analog output correction.  FUN mode-[I/O]-[ANALOG]-[ADJUST]-[ON]	p.134
I want to acquire a profile at each input of the measurement trigger.	Set trigger synchronized output.  FUN mode-[I/O]-[SERIAL]-[AUTO]	p.155

Phenomenon	Corrective action	Reference
I want to display the profile at a larger size for verification.	Set the enlarged profile display.  RUN mode-F4 key-[MGNIFY]	p.67
	If the setup support software Smart Monitor ZG2 packaged with the Sensor Controller ZG2-WDC11A/41A is used, more detailed profiles that cannot be fully verified on the Controller's LCD monitor can be verified on a PC's larger size screen.	p.152

Menu List

Enabled only in the expert menu

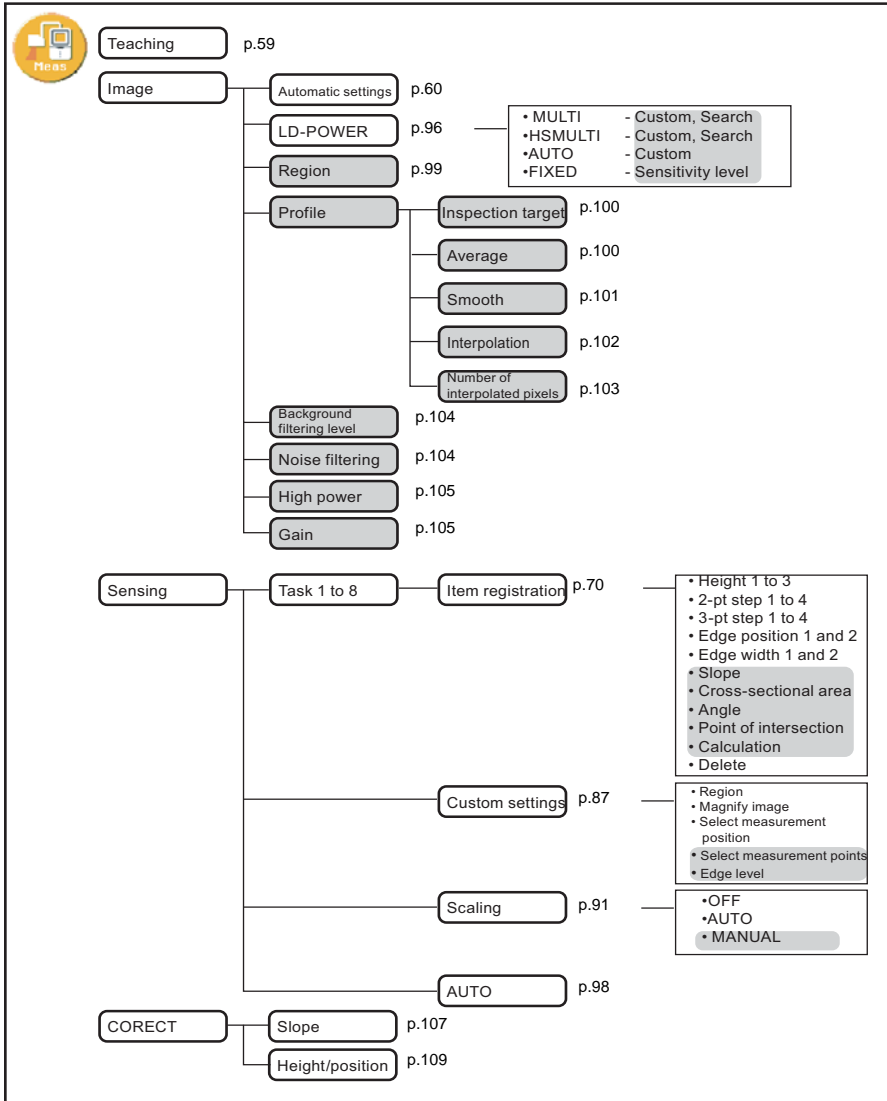







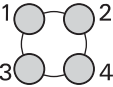

	Bank switching	p.116
	Copying banks	p.116
	Clearing banks	p.117

	Analog	Task	p.132	I/O line	Bank	p.136
		Scaling	p.132		Trigger	p.136
		Clamp	p.135		GATE period	p.137
		Correction	p.134		GATE delay	p.137
	RPD output	Output	p.143	Serial communication	AUTO	p.155
		Task	p.143		Output assignments	p.155
		Display number of digits past the decimal point	p.143	I/O monitor	p.137	

	Save	p.123	Sensor Head data	p.121
	Initialization	p.56	Number of digits past the decimal point	p.122
	Mounting of Sensor Head	p.118	ECO mode	p.122
	CCD Mode	p.121	Information	p.122
	RS-232C	p.156	Language	p.123
	Node	p.156	Icon color	p.123

List of Key Operations

The functions of keys differ according to the currently selected mode.

Key	Description		
	FUN mode	ADJ mode	RUN mode
Function keys 	These keys directly set the icon and No. preceding the items displayed on the LCD screen.		These keys can be used as function keys.  p.68
← LEFT key → RIGHT key  	Function changes depending on the settings. <ul style="list-style-type: none"> • Scrolls the page. • Selects the digit of numerical values. • Moves the cursor. • Specifies the region. 		—
↑ UP key ↓ DOWN key  	Moves the cursor and changes the numerical value.	Switches the displayed task.	
MENU/ VIEW key 	Displays the top menu.	Switches the display content.	
SET key 	Applies the item you are setting up.		Executes a zero reset.
ESC key 	Returns to the previous menu.		Hold down for at least two seconds to cancel a zero reset.

Laser Safety

Various safety standards regarding laser products are stipulated depending on the country of use.

Take safety measures according to each standard.

Classification

Sensor Head Type	Standards and classification (*1)		Maximum Output of Laser Beam
	JIS C 6802 2005 (Japan), EN60825/IEC60825-1(Europe)	FDA (the United States)	
ZG2-WDS70/WDS22/ WDS8T	Class 2M	Class IIIB	Max. output 5 mW Max. exposure (when optical device is not used) 1 mW
ZG2-WDS3VT	Class 2	Class II	Max. output 1 mW

*1 For products exported to the countries other than Japan and Europe, different safety standards are applied according to the countries. Check the LED safety regulations and standards of the relevant country.

Label Replacement

Use in the U.S.A.

Products relevant to FDA are supplied with labels that conform to FDA regulations.

When these products are used in the U.S.A., replace the warning label on the sensor body with the FDA labels (supplied) referring to the figure below. Make sure that the labels are affixed at the correct locations as indicated.

The ZG Series is intended to be fitted into a system as a terminal device. Follow the following technical standards when fitting in the device.

* FDA: 21CFR 1040.10 and 1040.11

FDA Labels

(1) DANGER/CAUTION Label

Class IIIB

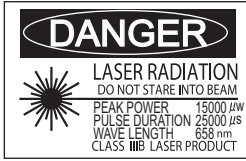

Class II

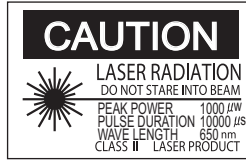

(2) Aperture Label

AVOID EXPOSURE
 Laser radiation is emitted from this aperture

(3) Certification and Identification Label

This laser product complies with 21 CFR 1040.10 and 1040.11.
 OMRON Corporation
 Shiokoji Horikawa, Shimogyo-ku, Kyoto 600-8530 JAPAN
 Place of manufacture: AYABE Factory, OMRON Corp.
 Manufactured in

Area to Attach Labels

ZG2-WDS70

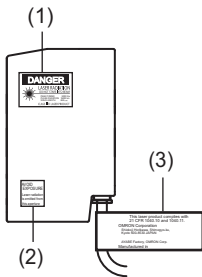

ZG2-WDS8T/WDS22

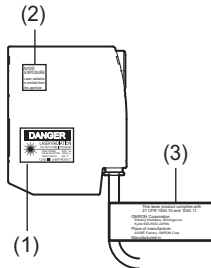

ZG2-WDS3VT

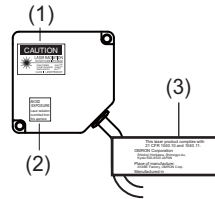

Use in Countries Other than the U. S. A.

The warning label written in Japanese is affixed to the Sensor unit. For countries other than the U.S.A., warning labels must be replaced by English ones (supplied with the Sensor unit).

EN60825/IEC60825-1 (Europe)

- Class 2



- Class 2M

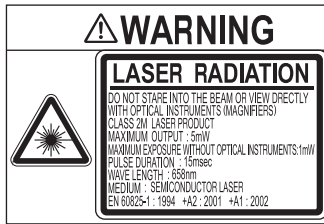

Requirements from Regulations and Standards

Summary of Requirements to Manufactures

For Europe

EN 60825-1 “Safety of Laser Products, Equipment Classification, Requirements and User’s Guide”

Summary of Manufacturer’s Requirements

Requirements subclause	Classification						
	Class 1	Class 1M	Class 2	Class 2M	Class 3R	Class 3B	Class 4
Description of hazard class	Safe under reasonably foreseeable conditions	As for Class 1 except may be hazardous if user employs optics	Low power; eye protection normally afforded by aversion responses	As for Class 2 except may be more hazardous if user employs optics	Direct intrabeam viewing may be hazardous	Direct intrabeam viewing normally hazardous	High power; diffuse reflections may be hazardous
Protective housing	Required for each laser product; limits access necessary for performance of functions of the products						
Safety interlock in protective housing	Designed to prevent removal of the panel until accessible emission values are below that for Class 3R				Designed to prevent removal of the panel until accessible emission values are below that for Class 3B		
Remote control	Not required					Permits easy addition of external interlock in laser installation	
Key control	Not required					Laser inoperative when key is removed	
Emission warning device	Not required				Give audible or visible warning when laser is switched on or if capacitor bank of pulsed laser is being charged. For Class 3R only, applies invisible radiation is emitted		
Attenuator	Not required					Give means beside the On/Off switch to temporarily to block beam	
Location controls	Not required				Controls so located that there is no danger of exposure to AEL above Classes 1 or 2 when adjustments are made		
Viewing optics	Not required	Emission from all viewing systems must be below Class 1M AEL					
Scanning	Scan failure shall not cause product to exceed its classification						
Class label	Required wording		Figures A required wording				

Requirements subclause	Classification						
	Class 1	Class 1M	Class 2	Class 2M	Class 3R	Class 3B	Class 4
Aperture label	Not required				Specified wording required		
Service entry label	Required as appropriate to the class of accessible radiation						
Override interlock label	Required under certain conditions as appropriate to the class of laser used						
Wavelength range label	Required for certain wavelength ranges						
LED label	Make required word substitutions for LED products						
User information	Operation manuals must contain instructions for safe use. Additional requirement apply for Class 1M and Class 2M						
Purchasing and service information	Promotion brochures must specify product classification; service manuals must contain safety information						

- Note:**
1. This table is intended to provide a convenient summary of requirements. See text of this standard for complete requirements.
 2. For the safety medical laser products, IEC 60601-2-22 applies
 3. AEL: Accessible Emission Limit
The maximum accessible emission level permitted within a particular class. For your reference, see ANSI Z136.1-1993, Section 2.

Symbol and border: black
Background: yellow

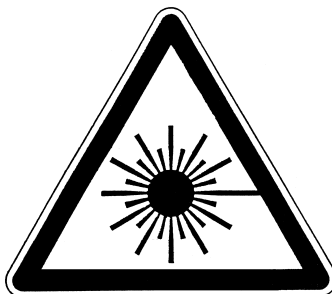

Figure A Warning label - Hazard symbol

Legend and border: black
Background: yellow

For U. S. A

FDA (Compliance Guide for Laser Products, 1985, according to 21 CFR1040.10)

Requirements	Class (see note 1)					
	I	Ila	II	IIIa	IIIb	IV
Performance (all laser products)						
Protective housing	R (see note 2)	R (see note 2)	R (see note 2)	R (see note 2)	R (see note 2)	R (see note 2)
Safety interlock	R (see notes 3,4)	R (see notes 3,4)	R (see notes 3,4)	R (see notes 3,4)	R (see notes 3,4)	R (see notes 3,4)
Location of controls	N/A	R	R		R	R
Viewing optics	R	R	R	R	R	R
Scanning safeguard	R	R	R	R	R	R
Performance (laser systems)						
Remote control connector	N/A	N/A	N/A	N/A	R	R
Key control	N/A	N/A	N/A	N/A	R	R
Emission indicator	N/A	N/A	R	R	R (see note 10)	R (see note 10)
Beam attenuator	N/A	N/A	R	R	R	R
Reset	N/A	N/A	N/A	N/A	N/A	R (see note 13)
Performance (specific purpose products)						
Medical	S	S	S	S (see note 8)	S (see note 8)	S (see note 8)
Surveying, leveling, alignment	S	S	S	S	NP	NP
Demonstration	S	S	S	S	S (see note 11)	(see note 11)
Labeling (all laser products)						
Certification & identification	R	R	R	R	R	R
Protective housing	D (see note 5)	D (see note 5)	D (see note 5)	D (see note 5)	D (see note 5)	D (see note 5)
Aperture	N/A	N/A	R	R	R	R
Class warning	N/A	R (see note 6)	R (see note 7)	R (see note 9)	R (see note 12)	R (see note 12)
Information (all laser products)						
User information	R	R	R	R	R	R
Product literature	N/A	R	R	R	R	R
Service information	R	R	R	R	R	R

Abbreviations:

- R:** Required.
N/A: Not applicable.
S: Requirements: Same as for other products of that Class. Also see footnotes.
NP: Not permitted.
D: Depends on level of interior radiation.

Footnotes:

- Note 1:** Based on highest level accessible during operation.
Note 2: Required wherever & whenever human access to laser radiation above Class I limits is not needed for product to perform its function.
Note 3: Required for protective housings opened during operation or maintenance, if human access thus gained is not always necessary when housing is open.
Note 4: Interlock requirements vary according to Class of internal radiation.
Note 5: Wording depends on level & wavelength of laser radiation within protective housing.
Note 6: Warning statement label.
Note 7: CAUTION logotype.
Note 8: Requires means to measure level of laser radiation intended to irradiate the body.
Note 9: CAUTION if 2.5 mW cm^2 or less, DANGER if greater than 2.5 mW cm^{-2} .
Note 10: Delay required between indication & emission.
Note 11: Variance required for Class IIb or IV demonstration laser products and light shows.
Note 12: DANGER logotype.
Note 13: Required after August 20, 1986.

Summary of Requirements to User

For Europe

EN 60825-1

Requirements subclause	Classification						
	Class 1	Class 1M	Class 2	Class 2M	Class 3R	Class 3B	Class 4
Laser safety officer	Not required but recommended for applications that involve direct viewing of the laser beam				Not required for visible emission Required for non-visible emission	Required	
Remote interlock	Not required					Connect to room or door circuits	
Key control	Not required					Remove key when not in use	
Beam attenuator	Not required					When in use prevents inadvertent exposure	
Emission indicator device	Not required				Indicates laser is energized for non-visible wavelengths	Indicates laser is energized	
Warning signs	Not required					Follow precautions on warning signs	
Beam path	Not required	Class 1M as for Class 3B (see note 2)	No required	Class 2M as for Class3B (see note 3)	Terminate beam at end of useful length		
Specular reflection	No requirements	Class 1M as for Class 3B (see note 2)	No requirements	Class 2M as for Class3B (see note 3)	Prevent unintentional reflections		
Eye protection	No requirements				Not required for visible emission Required for non-visible emission	Required if engineering and administrative procedures not practicable and MPE exceeded	
Protective clothing	No requirements					Sometimes required	Specific requirements
Training	No requirements	Class 1M as for Class 3R (see note 2)	No requirements	Class 2M as for Class3R (see note 3)	Required for all operator and maintenance personnel		

- Note:**
1. This table is intended to provide a convenient summary of requirements. See text of this standard for complete precautions.
 2. Class 1M laser products that failed condition 1 of table10 of the standard. Not required for Class 1M laser products that failed condition 2 of table10 of the standard. See the text for details.
 3. Class 2M laser products that failed condition 1 of table10 of the standard. Not required for Class 2M laser products that failed condition 2 of table10 of the standard. See the text for details.

For U. S. A

ANSI Z136.1:1993 “American National Standard for the Safe Use of Lasers” Control Measures for the Four Laser Classes

Control measures	Classification					
	1	2a	2	3a	3b	4
Engineering Controls	1	2a	2	3a	3b	4
Protective Housing (4.3.1)	X	X	X	X	X	X
Without Protective Housing (4.3.1.1)	LSO (see note 2) shall establish Alternate Controls					
Interlocks on Protective Housing (4.3.2)	☆	☆	☆	☆	X	X
Service Access Panel (4.3.3)	☆	☆	☆	☆	X	X
Key Control (4.3.4)	---	---	---	---	•	X
Viewing Portals (4.3.5.1)	---	---	MPE	MPE	MPE	MPE
Collecting Optics (4.3.5.2)	MPE	MPE	MPE	MPE	MPE	MPE
Totally Open Beam Path (4.3.6.1)	---	---	---	---	X NHZ	X NHZ
Limited Open Beam Path (4.3.6.2)	---	---	---	---	X NHZ	X NHZ
Enclosed Beam Path (4.3.6.3)	None is required if 4.3.1 and 4.3.2 fulfilled					
Remote Interlock Connector (4.3.7)	---	---	---	---	•	X
Beam Stop or Attenuator (4.3.8)	---	---	---	---	•	X
Activation Warning Systems (4.3.9)	---	---	---	---	•	X
Emission Delay (4.3.9.1)	---	---	---	---	---	X
Indoor Laser Controlled Area (4.3.10)	---	---	---	---	X NHZ	X NHZ
Class 3b Laser Controlled Area (4.3.10.1)	---	---	---	---	X	---
Class 4 Laser Controlled Area (4.3.10.2)	---	---	---	---	---	X
Laser Outdoor Controls (4.3.11)	---	---	---	---	X NHZ	X NHZ
Laser in Navigable Airspace (4.3.11.2)	---	---	---	•	•	•
Temporary Laser Controlled Area (4.3.12)	☆ MPE	☆ MPE	☆ MPE	☆ MPE	---	---
Remote Firing & Monitoring (4.3.13)	---	---	---	---	---	•
Labels (4.3.14 and 4.7)	X	X	X	X	X	X
Area Posting (4.3.15)	---	---	---	•	X NHZ	X NHZ
Administrative & Procedural Controls	1	2a	2	3a	3b	4

Control measures	Classification					
Standard Operating Procedures (4.4.1)	---	---	---	---	•	X
Output Emission Limitations (4.4.2)	---	---	---	LSO Determination		
Education and Training (4.4.3)	---	---	•	•	X	X
Authorized Personnel (4.4.4)	---	---	---	---	X	X
Alignment Procedures (4.4.5)	---	---	X	X	X	X
Protective Equipment (4.4.6)	---	---	---	---	•	X
Spectator (4.4.7)	---	---	---	---	•	X
Service Personnel (4.4.8)	☆ MPE	☆ MPE	☆ MPE	☆ MPE	X	X
Demonstration with General Public (4.5.1)	MPE+	---	X	X	X	X
Laser Optical Fiber Systems (4.5.2)	MPE	MPE	MPE	MPE	X	X
Laser Robotic Installations (4.5.3)	---	---	---	---	X NHZ	X NHZ
Eye Protection (4.6.2)	---	---	---	---	• MPE	X MPE
Protective Windows (4.6.3)	---	---	---	---	X NHZ	X NHZ
Protective Barriers and Curtains (4.6.4)	---	---	---	---	•	•
Skin Protection (4.6.5)	---	---	---	---	X MPE	X MPE
Other Protective Equipment (4.6.5)	Use may be required					
Warning Signs and Labels (4.7) (Design Requirements)	---	---	•	•	X NHZ	X NHZ
Service and Repairs (4.8)	LSO Determination					
Modification of Laser Systems (4.9)	LSO Determination					

Note: 1. LEGEND

- X: Shall
 - : Should
 - : No requirement
 - ☆: Shall if enclosed Class 3b or Class 4
 - MPE: Shall if MPE is exceeded
 - NHZ: Nominal Hazard Zone analysis required
 - +: Applicable only to UV and IR Lasers (4.5.1.2)
2. LSO: Laser Safety Officer

An individual shall be designated the Laser Safety Officer with the authority and responsibility to monitor and enforce the control of laser hazards, and to effect the knowledgeable evaluation and control of laser hazards.

For your reference, see ANSI Z136.1993, Section 1.3.

Definitions of Laser Classification

For Europe

Laser Product Classifications

EN

Class	Description
Class 1	Safe under reasonably foreseeable conditions
Class 1M	As for Class 1 except may be hazardous if user employs optics
Class 2	Low power; eye protection normally afforded by aversion responses
Class 2M	As for Class 2 except may be more hazardous if user employs optics
Class 3R	Direct intrabeam viewing may be hazardous
Class 3B	Direct intrabeam viewing normally hazardous
Class 4	High power; diffuse reflections may be hazardous

Note: Conditions for safe viewing of diffuse reflections for Class 3B visible lasers are: minimum viewing distance of 13 cm between screen and cornea and a maximum viewing time of 10 s. Other viewing conditions require a comparison of the diffuse reflection exposure with the MPE.

For U. S. A

Comparison of Classifications between FDA and ANSI

Class	FDA definition	ANSI description
Class I/1	Limits applicable to devices that have emissions in the ultraviolet, visible, and infrared spectra, and limits below which biological hazards have not been established.	A Class 1 laser is considered to be incapable of producing damaging radiation levels during operation and maintenance and is, therefore, exempt from any control measures or other forms of surveillance.
Class IIa/2a	Limits applicable to products whose visible emission does not exceed Class I limits for emission durations of 1,000 seconds or less and are not intended for viewing.	Class 2 lasers are divided into two subclasses, 2 and 2a. A Class 2 laser emits in the visible portion of the spectrum (0.4 to 0.7 μm) and eye protection is normally afforded by the aversion response including the blink reflex.
Class II/2	Limits applicable to products that have emissions in the visible spectrum (400 to 710 nm) for emission durations in excess of 0.25 second, providing that emissions for other durations and/or wavelengths do not exceed the Class I limits. Class II products are considered hazardous for direct long-term ocular exposure.	

Class	FDA definition	ANSI description
Class IIIa/3a	Limits to products that have emissions in the visible spectrum and that have beams where the total collectable radiant power does not exceed 5 milliwatts.	Class 3 lasers are divided into two subclasses, 3a and 3b. A Class 3 laser may be hazardous under direct and specular reflection viewing conditions, but the diffuse reflection is usually not a hazard.
Class IIIb/3b	Limits applicable to devices that emit in the ultraviolet, visible, and infrared spectra. Class IIIb products include laser systems ranging from 5 to 500 milliwatts in the visible spectrum. Class IIIb emission levels are ocular hazards for direct exposure throughout the range of the Class, and skin hazards at the higher levels of the Class.	
Class IV/4	Exceeding the limits of Class IIIb and are a hazard for scattered reflection as well as for direct exposure.	A Class 4 laser is a hazard to the eye or skin from the direct beam and sometimes from a diffuse reflection and also can be a fire hazard. Class 4 lasers may also produce laser-generated air contaminants and hazardous plasma radiation.

Compliance with EC Directives

CE marking	Applicable directive		Safety category
	Low-Voltage directive	EMC directive	
Compliance ^(*1)	Exception	Complied ^(*1)	B

*1 For details of detailed compliance levels, we have issued the "EC Declaration of Conformity: EN45014."
Please contact your OMRON sales representative.

Updating the Firmware

This section describes how to update the firmware of ZG2 series Controllers (such as ZG2-WDC). Use Warp Engine Zero to update the firmware.

For the file for the firmware update and Warp Engine Zero, please contact your OMRON representative.

Important

- During a firmware update, do not turn the Controller OFF. Doing so will prevent the Controller from functioning normally.
- When installing Smart Monitor and the USB driver, log in as an administrator or a user having the same privileges as a computer administrator for changing system settings.

Connecting the Controller to the PC

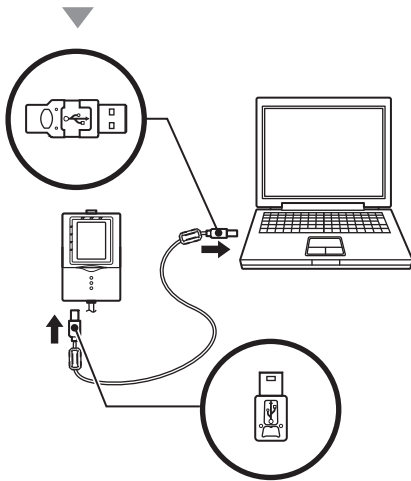

1 Connect the Controller to the PC with a USB cable.

When connecting the Controller to a PC for the first time, the USB driver must be installed in advance.

2 Turn the Controller ON.

Important

Make sure that the Controller's power supply is connected securely. When the power is turned OFF during a firmware update, the Controller breaks down and can no longer start up normally.

3 Set the Controller's mode switch to FUN.

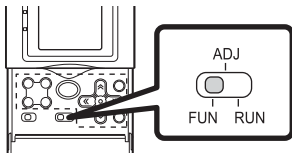

4 Install Warp Engine Zero on the PC.

Starting Up Warp Engine Zero

Important

Start Warp Engine Zero only when the PC recognizes the Controller normally.



- 5 Select [Programs]-[OMRON]-[SmartMonitorZG2]-[WarpEngineZero] from the Windows [Start] menu. The [WarpEngineZero] window is displayed.

If startup of Warp Engine Zero fails, a message is displayed, followed by the dialog box shown on the left. Skip to "Setting the Connection Port" (p.236).

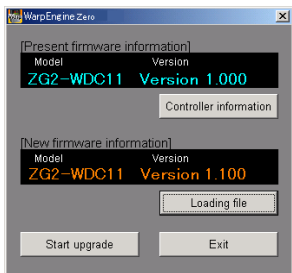

6 Click the [Controller information] button if necessary.

The model and version of the currently connected Controller are displayed.

7 Click the [Loading file] button to select the file to be written.

The model and version of the Controller that is held in the file are displayed.

Updating the firmware

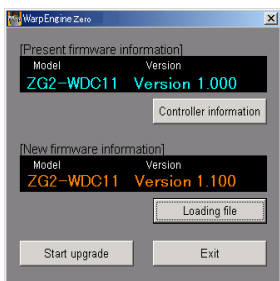

8 Click the [Start upgrade] button.

A message indicating the start of the update is displayed.

Important

If the message “the model is not the same” is displayed when you click the [Start upgrade] button, this means that the model of the connected Controller and the model information in the specified file do not match. In this case, do not update the firmware. The Controller will break down and can no longer start up normally.

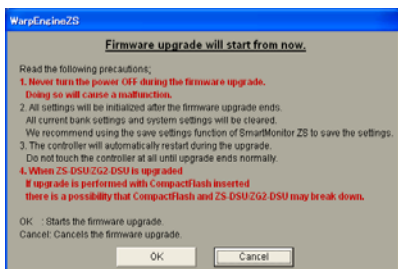

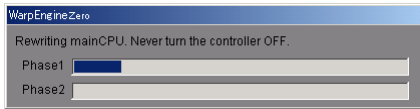

9 Check the message and click the [OK] button.

The firmware update will start.

During the update, the progress status will be displayed. Wait until a message informing completion of the update is displayed. (The update takes several minutes to complete).

Important

- During a firmware update, an error may occur on the Controller. Please wait.
- If the update progress bar stops or the update is not completed within ten minutes, there is a possibility that the update has failed.
- In this case, notify an OMRON sales representative of the firmware version before the update and the firmware version in the write file.

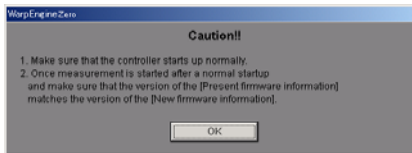
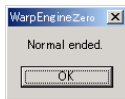

10 When the update is completed, the completion message is displayed. Follow the on-screen instructions.

11 Check the message and click the [OK] button.

Important

After the firmware update is completed, initialize the Controller.

 p.56

Setting the Connection Port



If startup of Warp Engine Zero fails, a message is displayed, followed by the dialog box shown below.

- 1 Select [Settings]-[Control Panel] from the [Start] menu in the PC and double-click [System].**

The [System Properties] dialog box is displayed.

- 2 Open the [Hardware] tab and click [Device Manager].**

The [Device Manager] dialog box is displayed.

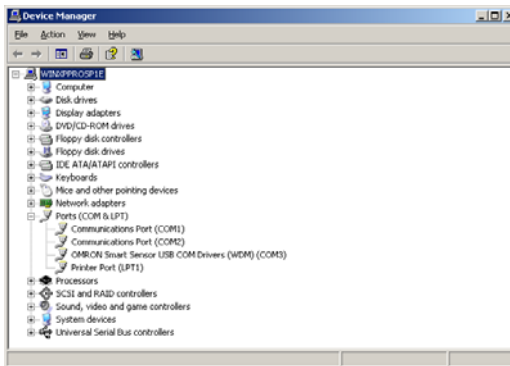

- 3 Open [Ports (COM&LPT)] and check the COM number in "OMRON Smart Sensor USB COM Drivers (WDM) (COMxx)".**

"(COMxx)" indicates the Controller's connection port.

- 4 Select the Controller's connection port from [COM Port], and click the [Set] button.**

Warp Engine Zero starts up.

Numerics

- 2-pt step 74
- 3-pt step 75

A

- ADJ mode 52
- APS function 60
- Auto output method 151
- AUTO sensitivity 26
- AVE
 - FILTER 111
 - MEAS 89
 - Profile 101

B

- Bank
 - Clearing 117
 - Copying 116
 - Switching 116
- BANKGET command 161
- BANKLOAD command 168
- BANKSAVE command 169
- BANKSET command 160
- BOTTOM 89

C

- Cables
 - Connecting 50
 - Extending 17, 51, 207
- Calculations Performed on Measurement Values Obtained on Multiple Channels 190
- CCD Mode
 - Setting 121
- CHGDISP command 172
- CHGET command 167
- CLAMP 135
- Command format 157
- Command response method 151

- Communication specifications 156
- Connecting Devices 49
- Connecting the Power Supply 51
- Control keys 20
- Controller
 - Common Settings 189
 - External dimensions 205
 - Gang-mounted 47, 48, 184
 - Link Unit 210
 - Mounting 39
 - Part Names and Functions 19
 - Specifications 203
- Controller information 122
- Correcting analog output values 134

D

- DATASET command 165
- DATAINIT command 166
- DATASAVE command 166
- DATASET command 165
- Digital monitor 67

E

- ECO mode 122
- Eco monitor 67
- Edge level 90
- Edge width 77
- ERROR 135
- EXP menu 20, 55

F

- Ferrite core 49
- FIXED sensitivity 26
- FUN mode 52
- Function extension connector 20
- Function keys 68

G

Gain 105
GATE signal 137

H

Height correction 109
High-resolution mode 121
High-speed mode 121

I

I/O cable 20
I/O circuit diagrams 130
I/O timing charts 144
Initialization 56

J

Judgment indicator 19

L

LANGUAGE 123
Laser emitter 18
Laser indicator 18, 19
Laser receiver 18
List of commands 159

M

MEAS 89
MEASURE command 162
Measurement items
 Setting 62, 70
Measurement range
 ZG2-WDS22 31
 ZG2-WDS3VT 37
 ZG2-WDS70 29
 ZG2-WDS8T 34
Measurement trigger 136
Measuring Wide Measurement Targets 185

Menu switch 20
MGNIFY 87
Mode switch 20
Mounting position
 ZG2-WDS22 30
 ZG2-WDS3VT 36
 ZG2-WDS70 28
 ZG2-WDS8T 33
MULTI sensitivity 26
Multi-task measurement 53
Mutual interference 200

N

Node No. 156
Number of digits past the decimal point
 Display digits 122
 Parallel Output Unit 143

P

Panel cutout dimensions 206
Parallel Output Unit 138
Parameter list 176
PEAK 89
Position correction 106, 109
Profile
 AVE 101
 Displaying 59
 FILLUP 102
 Magnifying 67
 Monitoring 66
 Screen 21
 Smooth 101
 SUPnum 103
PROFILE command 173

R

REGION 99
Response format 157
RS-232C communication specifications 156
RS-232C connector 20
RUN mode 52

S

-
- Save 123
 - Scaling 91
 - Analog output 132
 - SEARCH command 175
 - Sensitivity adjustment 96
 - Sensor Head
 - External dimensions 196
 - Mounting 27
 - Mutual interference
 - Adjusting 200
 - Part Names and Functions 18
 - Setting Mutual Interference
 - Prevention 187
 - Specifications 194
 - Sensor Head connector 20
 - Sensor Head
 - Data Loading Method 121
 - Setting regions 63
 - Setting the icon color 123
 - Slope correction 107
 - SMOOTH 111
 - Standard mode 121
 - STD menu 20, 55
 - Step 74
 - Switching bank data 136
 - SYSLOAD command 170
 - SYSSAVE command 171
 - System Configuration 16

T

-
- Task
 - Analog output 132
 - Serial output 155
 - Tasks and bank data 53
 - TEACH 61
 - TRIG command 163
 - Trigger indicator 19

U

-
- Updating the firmware 232
 - USB port 20

V

-
- VERGET command 174
 - Voltage/Current switch 20

W

-
- Wiring the I/O cable 127

Z

-
- ZERO 114
 - Zero Reset indicator 19
 - ZEROCLEAR command 164
 - ZERORST command 164

Revision History

A manual revision code appears as a suffix to the catalog number at the bottom of the front and back covers of this manual.

Cat. No. Z288-E1-01



Revision code

Revision code	Revision date	Revised content
01	December 2008	First edition